

contents of tube  
with screw cap  
1101.6µl

total volume tube  
1216.8µl

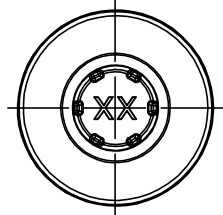

working volume  
in cryo storage  
945µl

"All dimensions in mm"

Customer drawing subject to change without notice!

Uncontrolled Copy

Prior Issue	Drawn	Approved	Released	CONFIDENTIAL: Information contained in this document or drawing is confidential and proprietary to Greiner Bio-One GmbH. This document may not be reproduced for any reason without written permission from Greiner Bio-One GmbH. All rights of design, invention, and copyright are reserved.
Revision 4	Date 2014/02/19	Date 2014/11/17	Date 2014/11/17	
Date 2014/09/25	Name schwarzj	Name falter	Name sonntag	

Valid for Item-No.: 978561, 978570, 978580, 978561-2D1, 978570-2D1, 978580-2D1

with capped tubes inserted

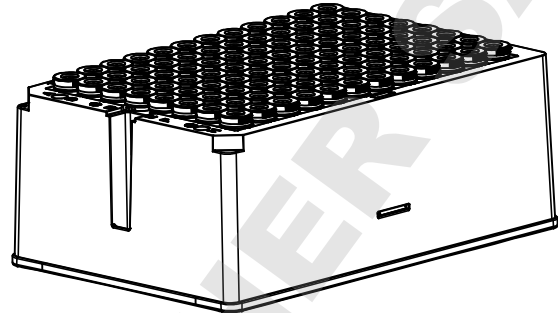
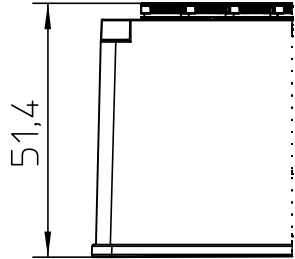

with uncapped tubes inserted

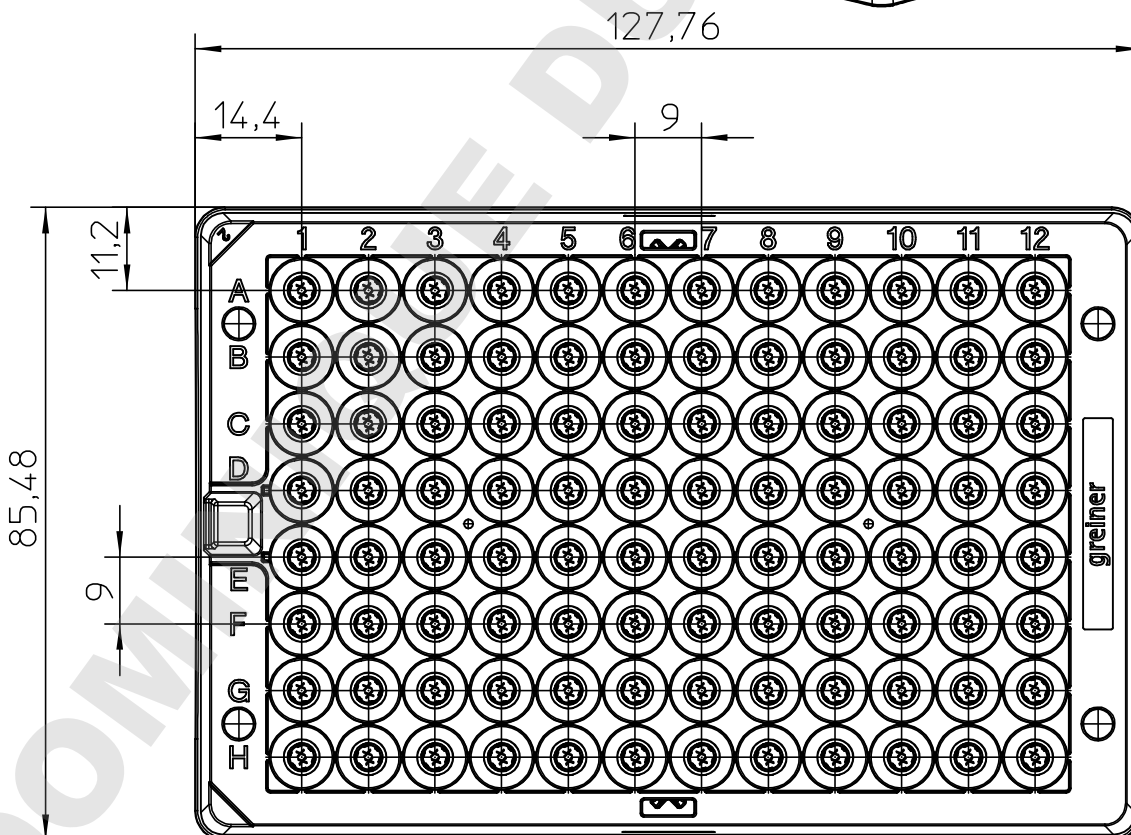
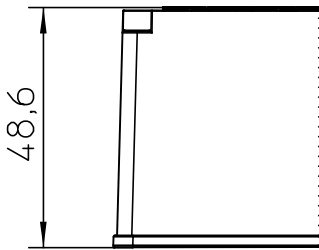

"All dimensions in mm"

Customer drawing subject to change without notice!

Uncontrolled Copy

Prior Issue	Drawn	Approved	Released	<small>CONFIDENTIAL: Information contained in this document or drawing is confidential and proprietary to Greiner Bio-One GmbH. This document may not be reproduced for any reason without written permission from Greiner Bio-One GmbH. All rights of design, invention, and copyright are reserved.</small>
Revision 4	Date 2014/02/19	Date 2014/11/17	Date 2014/11/17	
Date 2014/09/25	Name schwarzj	Name falter	Name sonntag	

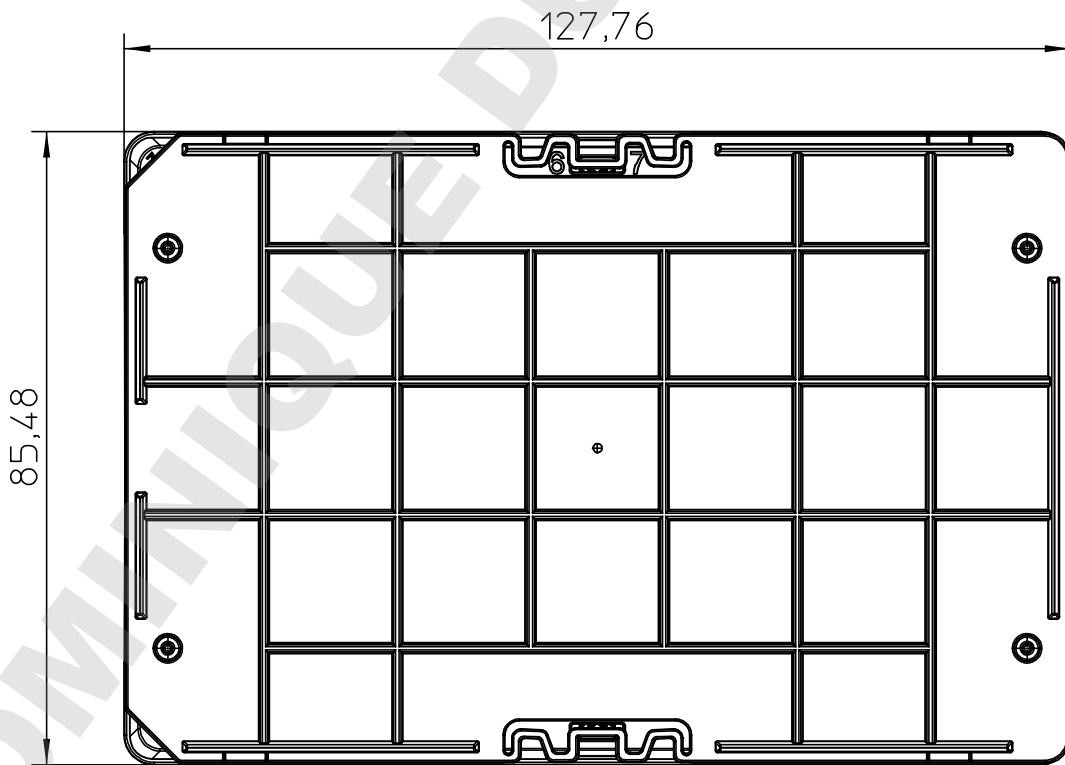
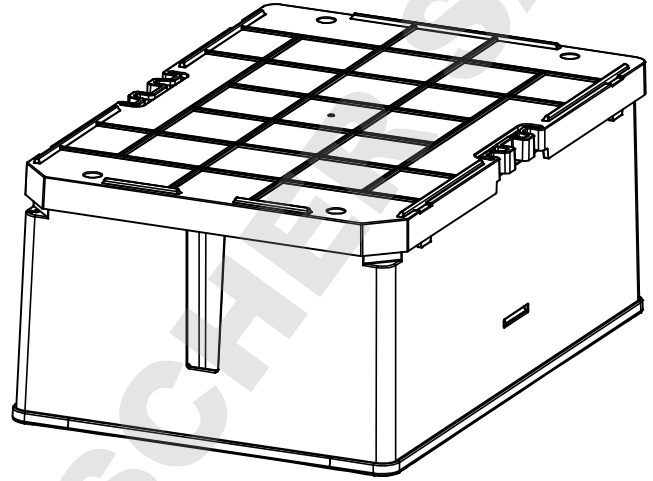
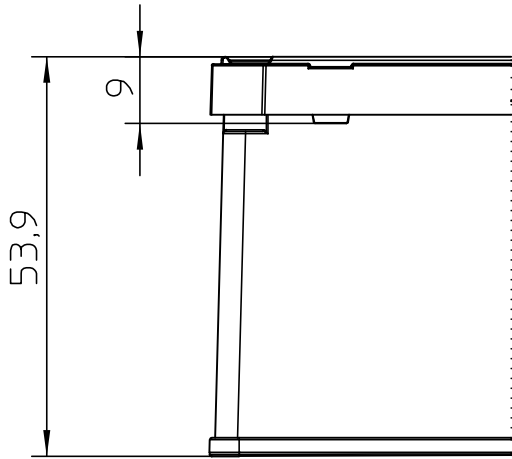

"All dimensions in mm"  
Customer drawing subject to change without notice!

**Uncontrolled Copy**

Prior Issue	Drawn	Approved	Released	CONFIDENTIAL: Information contained in this document or drawing is confidential and proprietary to Greiner Bio-One GmbH. This document may not be reproduced for any reason without written permission from Greiner Bio-One GmbH. All rights of design, invention, and copyright are reserved.
Revision 4	Date 2014/02/19	Date 2014/11/17	Date 2014/11/17	
Date 2014/09/25	Name schwarzj	Name falter	Name sonntag	