

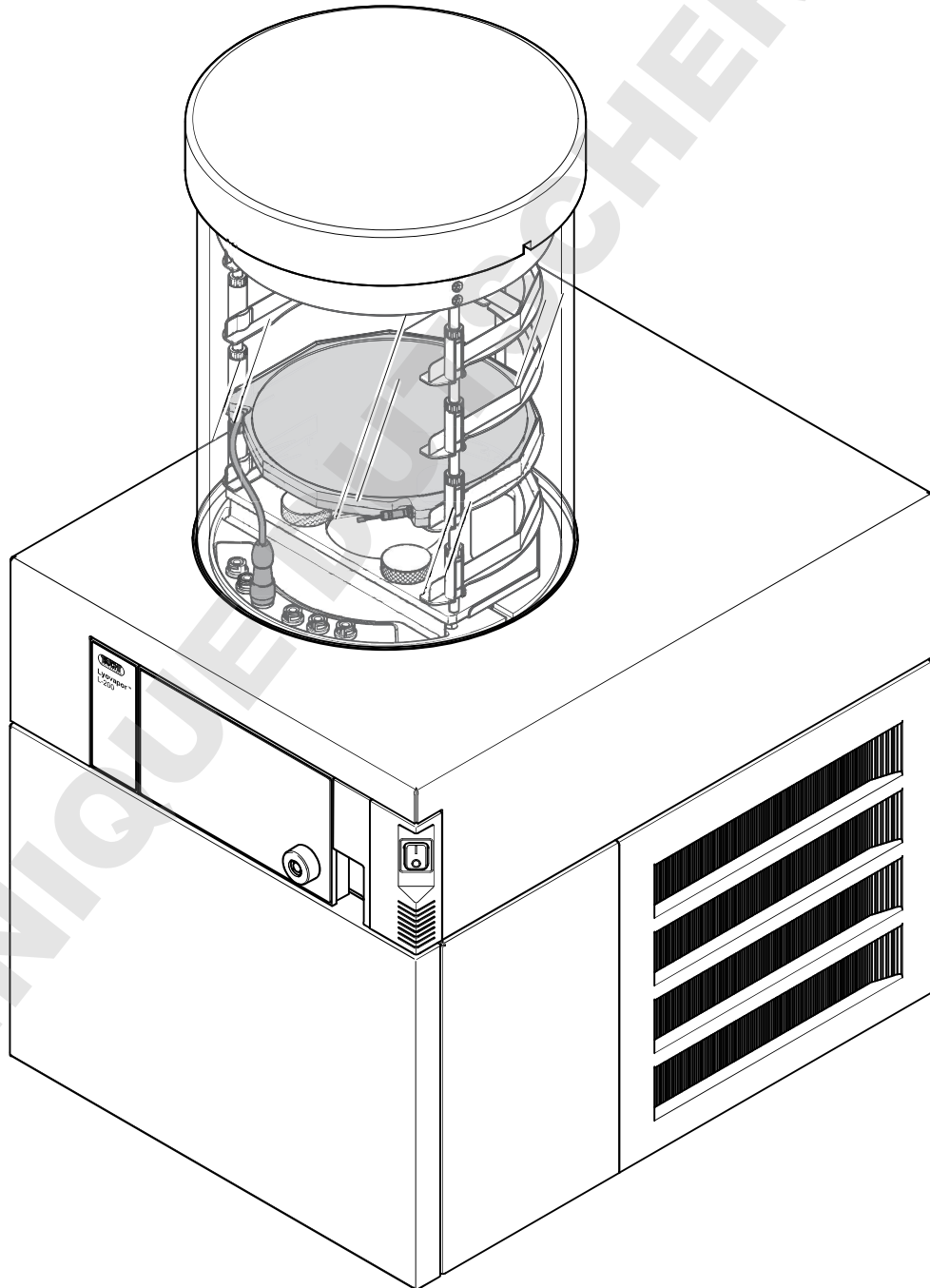

## Lyovapor™ L-200

### Technical data sheet

The compact Lyovapor™ L-200 offers high-quality Freeze Drying (-55 °C, 6 kg) with a high level of automation. Infinite-Control includes easy method creation, method running, data logging, chart recording in real time and interruption if needed at anytime - anywhere.



## Overview of Lyovapor™ L-200 Solutions

	L-200 Classic	L-200 Pro Control
Lyovapor™ L-200	1	1
Vacuum sensor	1	1
Main valve	1	1
Aeration valve	1	1
Regulation valve	1	1
Vacuum pump	*	*
Drying chamber heatable shelf	-	1
Drying chamber non-heatable shelf	1	-
Drying chamber rack manifold	1	1
User interface	1	Pro
Additional external vacuum sensors	-	*
Lyovapor™ Software	-	*
BUCHI Monitor APP	1	1

\* Optional, according to order code

## Order Code

Choose the configuration according to your needs:

### Lyovapor™ L-200 Classic

1	1	L	2	0	0	I	N										0	
---	---	---	---	---	---	---	---	--	--	--	--	--	--	--	--	--	---	--

**Drying chamber** \_\_\_\_\_

- 000 Without
- 010 Manifold rack 12
- 020 Manifold rack 24
- 141 Shelves 4
- 142 Shelves 4 & manifold top 12
- 161 Shelves 6
- 162 Shelves 6 & manifold top 12

**Pressure control** \_\_\_\_\_

- 2 Advanced vacuum control

**Sample temperature sensor** \_\_\_\_\_

- 0 Without sensor

**Software** \_\_\_\_\_

- 0 Without software

**Vacuum pump** \_\_\_\_\_

- 0 Without vacuum pump
- 1 Vacuum pump "Pfeiffer Duo 6"
- 3 Vacuum pump "Edwards nXDS6iC"

**Trolley** \_\_\_\_\_

- 0 Without
- 1 Convenient mobile trolley

**Voltage/Frequency** \_\_\_\_\_

- 1 220 – 240 V (50 Hz)
- 2 208 – 230 V (60 Hz)

## Order Code

Choose the configuration according to your needs:

### Lyovapor™ L-200 Pro Control

<b>1</b>	<b>1</b>	<b>L</b>	<b>2</b>	<b>0</b>	<b>0</b>	<b>P</b>	<b>H</b>										<b>0</b>	
----------	----------	----------	----------	----------	----------	----------	----------	--	--	--	--	--	--	--	--	--	----------	--

**Drying chamber**

- 000 Without
- 241 Heatable shelves 4
- 242 Heatable shelves 4 & manifold top 12
- 243 Heatable shelves 4 & stoppering top
- 261 Heatable shelves 6
- 262 Heatable shelves 6 & manifold top 12

**Pressure control**

- 2 Advanced vacuum control

**Sample temperature sensor**

- 0 Without sensor
- 1 With sensor (quantity according to shelf amount)

**Software**

- 0 Without software
- 1 Software

**Vacuum pump**

- 0 Without vacuum pump
- 1 Vacuum pump "Pfeiffer Duo 6"
- 3 Vacuum pump "Edwards nXDS6iC"

**Trolley**

- 0 Without
- 1 Convenient mobile trolley

**Voltage / Frequency**

- 1 220 – 240 V (50 Hz)
- 2 208 – 230 V (60 Hz)

## Order Code

Choose the configuration according to your needs:

### Drying chambers with heating options

The amount of optional sample temperature sensors is determined by the ordered shelves. One sensor for each shelf.



#### Shelf type

- 2 Heatable shelf

#### Amount of shelves

- 1 shelves
- 2 shelves
- 3 shelves
- 4 shelves
- 5 shelves
- 6 shelves

#### Top cover type

- 1 Plain
- 2 Manifold
- 3 Stoppering (only 4 shelves)

#### Sample temperature sensor

- 0 Without temperature sensor
- 1 With temperature sensor

DOMINIQUE DUTSCHER SAS

## Scope of delivery

All configurations are supplied ready to use.

Component	Lyovapor™ L-200
Lyovapor™ L-200 or Lyovapor™ L-200 Pro	1
Power cord	1
Operation Manual	1
Technical data sheet	1
Vacuum clamp, ISO-KF 16	1
Vacuum clamps, ISO-KF 25	1
O-ring 300 mm	1
Vacuum tubing adaptor, ISO-KF 16 to ISO-KF 25	1
Cross-pipe (inc. seals and clamps)*	1
90° elbow, ISO-KF 16	2
Main valve (inc. seals and clamps)	1
Pressure regulating valve (inc. seals and clamps)	1
Pressure sensor PPG010 (inc. seals and clamps)	1
Aeration valve (inc. seals and clamps)	1

## Technical data

### Lyovapor™ L-200

Specification	L-200 for 50Hz	L-200 for 60Hz
Dimensions without drying attachments (W x D x H)	460 × 585 × 510 mm	460 × 585 × 510 mm
Weight	75 kg	75 kg
Minimum clearance on all sides	300 mm	300 mm
Connection voltage	220-240 VAC	208-230 VAC
Power consumption (rated)	1200 W	1200 W
Power consumption (maximum)	1800 W	1800 W
Lug	10 A/250 V	10 A/250 V
Frequency	50 Hz	60 Hz
Overvoltage category	II	II
Protection rating	IP20	IP20
Pollution degree	2	2
Condensing capacity at 20 °C ambient temperature	≥ 6 kg / 24 h	≥ 6 kg / 24 h
Lowest condenser temperature	-55 °C	-55 °C
Temperature divergence	± 3.0 °C	± 3.0 °C
Condenser capacity	≤ 6 kg	≤ 6 kg

Specification	L-200 for 50Hz	L-200 for 60Hz
Condenser surface area	1410 cm <sup>2</sup>	1410 cm <sup>2</sup>
Number of compressors	1	1
Refrigerant	R507 CFC-free	R507 CFC-free
Refrigerant quantity	485 g	442 g
Drying shelf temperature	up to 60 °C	up to 60 °C
Inert gas pressure	1.1 - 1.2 bar (max. 2 bar)	1.1 - 1.2 bar (max. 2 bar)
Drying shelf temperature tolerance	± 1.0 °C	± 1.0 °C
Cooling capacity compressor	1.97 kW	2.33 kW
Vacuum generation time to 0.1 mbar*	Typically ≤ 10 min	Typically ≤ 10 min
Volume-based leakage rate*	Typically ≤ 0.001 mbar x L/sec	Typically ≤ 0.001 mbar x L/sec
Minimum system vacuum*	Typically ≤ 30 mTorr	Typically ≤ 30 mTorr
Optimum control range vacuum*	50 to 500 mTorr	50 to 500 mTorr

\* With Pfeiffer Duo 6 vacuum pump / without samples

### Ambient conditions

For indoor use only.

Max. altitude above sea level	2000 m
Ambient temperature	15 - 30°C
Maximum relative humidity	80 % for temperatures up to 30°C
Storage temperature	max. 45°C

## Installation requirements

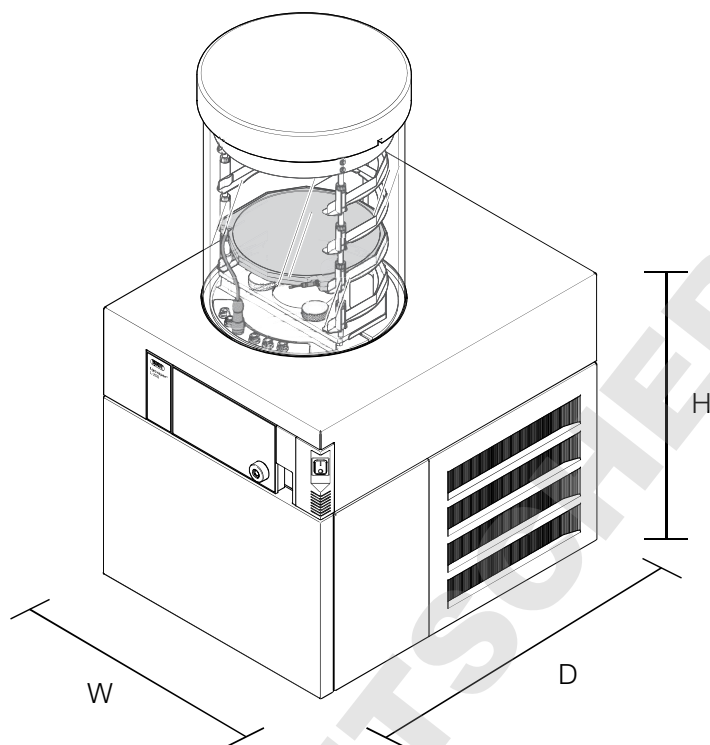

W = 460 mm + 300 mm Clearance

D = 585 mm + 300 mm Clearance (incl. vacuum regulation and vacuum hose)

H = 510 mm + 400 mm Clearance (up to 1100 mm depending on configuration)

### Power supply

Frequency	50 Hz	60 Hz
Connection voltage	220-240 VAC	208-230 VAC
Power consumption (rated)	1200 W	1200 W
Lug	10 A/250 V	10 A/250 V

### Pump requirements

Connecting voltage	180 – 265 V
End pressure with gas ballast	$3 \times 10^{-3}$ hPa
End pressure without gas ballast	$3 \times 10^{-3}$ hPa
Absorption capacity 50 Hz	5 m <sup>3</sup> / h
Absorption capacity 60 Hz	6 m <sup>3</sup> / h
Maximum power consumption	550 W



## Plain Instrument

Plain Instrument	Order no.
Lyovapor™ L-200, 50 Hz	11L200IN0000000001
Lyovapor™ L-200, 60 Hz	11L200IN0000000002
Lyovapor™ L-200 Pro, 50 Hz	11L200PH0000000001
Lyovapor™ L-200 Pro, 60 Hz	11L200PH0000000002
Upgrade Kit	11065846
To upgrade the L-200 to L-200 Pro. Contains user interface Pro, adapter and electricity for heatable shelf connections	

## Drying chamber bundles



Drying rack manifold	Order no.
Drying rack manifold 12 with 12 manifold valves and baseplate	11DCIN01000
Drying rack manifold 24 with 24 manifold valves and baseplate	11DCIN02000

Drying chamber non-heatable shelves	Order no.
Drying chamber 4 shelves with top cover, support ring and 4 non-heatable shelves	11DCIN14100
Drying chamber manifold, 4 shelves with top cover manifold, support ring, 4 non-heatable shelves and 12 manifold valves	11DCIN14200
Drying chamber 6 shelves with top cover, support ring and 6 non-heatable shelves	11DCIN16100
Drying chamber manifold, 6 shelves with top cover manifold, support ring, 6 non-heatable shelves and 12 manifold valves	11DCIN16200

Drying chamber heatable shelves	Order no.
Drying chamber 4 heatable shelves with top cover, 4 heatable shelves and 4 sample temperature sensors	11DCPH24110
Drying chamber manifold, 4 heatable shelves with top cover manifold, 4 heatable shelves, 12 manifold valves and 4 sample temperature sensors	11DCPH24210
Drying chamber stoppering, 4 heatable shelves with top cover stoppering, 4 heatable shelves and 4 sample temperature sensors	11DCPH24310
Drying chamber manifold, 6 heatable shelves with top cover manifold, 6 heatable shelves, 12 manifold valves and 6 sample temperature sensors	11DCPH26210
Drying chamber 6 heatable shelves with top cover, 6 heatable shelves and 6 sample temperature sensors	11DCPH26110

## Spare parts and accessories

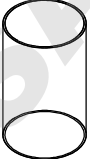
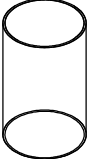
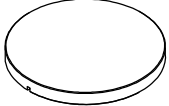
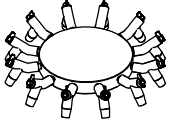
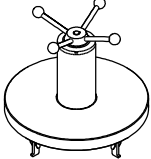
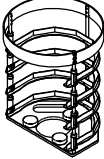
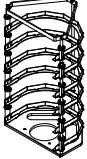

### Top-mount drying rack accessories

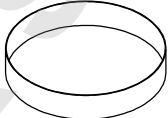
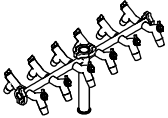
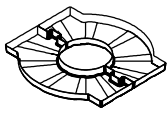
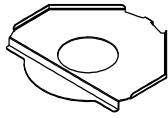
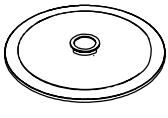
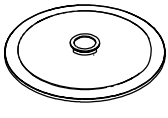
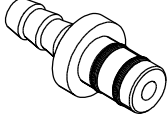
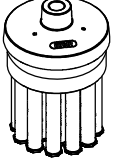
	Order no.	Image
Drying chamber tube, PMMA, for 4 shelves L 368 mm, Ø 300 mm	11063278	
Drying chamber tube, PMMA, for 6 shelves L 480 mm, Ø 300 mm	11065093	
Top cover, PMMA, without sealing Ø 300 mm, H 50 mm	11062912	
Top cover manifold, PMMA, with 12 valves, without sealing Ø 300 mm, W 546 mm, H 127 mm	11065595	
Top cover stoppering, without sealing only for rack for 4 heatable shelves Ø 300 mm, H 330 mm, W 320 mm	11064314	
Rack for 4 heatable shelves H 356 mm, Ø 265 mm, shelf distance 30-75 mm	11065102	
Rack for 6 heatable shelves H 468 mm, Ø 265 mm, shelf distance 30-75 mm	11065103	
Heatable shelf, aluminum coated, with connection cable Ø 219.5 mm, surface area 376 cm <sup>2</sup>	11064095	

	Order no.	Image
Sample tray, stainless steel Ø 220 mm, H 18.5 mm	11061439	
Ferrule, Ø 218 mm, H 40 mm	11065816	
Drying rack manifold, stainless steel, with 12 valves H 340 mm, W 777 mm	11063664	
Drip pan, for manifold	11066358	
Support for rack, stainless steel H 4 mm	11063789	
Baseplate, stainless steel, for manifold rack	11064953	
Baseplate, PMMA, for manifold rack	11065733	
Suction nipple For manifold application to create vacuum in sample flasks	11065819	
Ampoule adapter for manifold with 19 ampoule connections and cap adapter	11065725	

	Order no.	Image
Manifold valve, natural rubber, with SJ 29/32	11062300	
Flask beaker for manifold 100 mL with cap adapter and integrated filter	11066140	
Flask beaker for manifold 200 mL with cap adapter and integrated filter	11066141	
Flask beaker for manifold 800 mL with cap adapter and integrated filter	11069474	
Flask beaker for manifold 1200 mL with cap adapter and integrated filter	11066143	
Manifold flask adapter set with 12 adapters, incl. filter paper	11066144	
Manifold flask adapter set with 6 adapters, incl. filter paper	11067334	
Manifold flask adapter set, US joint size with 12 adapters, incl. filter paper	11066171	
Manifold flask adapter set, US joint size with 6 adapters, incl. filter paper	11067333	

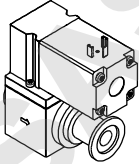
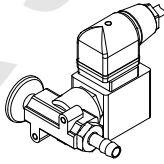
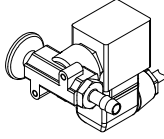
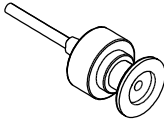
## Accessories

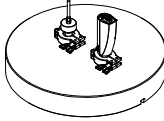
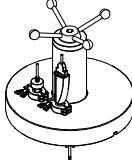

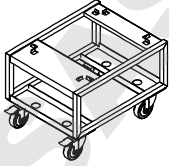
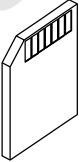
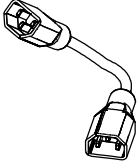

	Order no.	Image
Main valve	11062223	
Pressure regulation valve	11064725	
Aeration valve	11064724	
Pirani / Piezo pressure sensor PPG010	11062228	
Capacitive pressure sensor Inficon CDG 020 D	11066564	
PT1000 sample temperature sensor	11064031	
Set for pressure difference test at L-200 incl. extension cable for PPG010 and CDG 020D sensors, PMMA top cover, seals and clamps	11067590	
Set for pressure difference test at L-200 incl. extension cable of PPG010 and CDG 020D sensors, stoppering top cover, seals and clamps	11070102	

## Further accessories

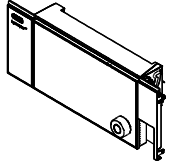
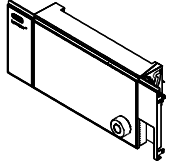
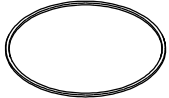
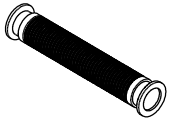
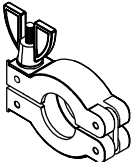
	Order no.	Image
Trolley L-200, stainless steel coated	11063692	
SD-Card 1 GB	11064730	
Connection cable, for vacuum pump	11064934	

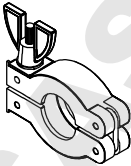
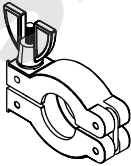
## Spare parts

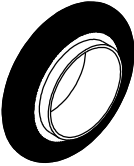
	Order no.	Image
User interface	11063580	
User interface Pro	11063581	
O-Ring Ø 300 mm	11065367	
Vacuum hose, KF 25, L 1000 mm	11066031	
Vacuum clamp KF 16	11064939	

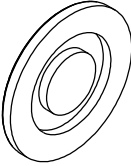
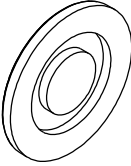
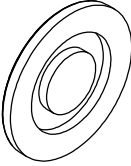
	Order no.	Image
Vacuum clamp KF 25	11063662	
Vacuum clamp, KF 40	11063663	
Vacuum seal KF 16	11063455	
Vacuum seal KF 25	11063457	
Vacuum seal KF 40	11063659	
Vacuum flange adapter, stainless steel, KF 16 to KF 25	11064870	
Blind flange KF 16	11064902	
Blind flange KF 25	11063660	
Blind flange KF 40	11063661	

## Software

	Order no.
Lyovapor™ software licence	11065668
Lyovapor™ software DVD	11065667

## Maintenance kits

	Order no.
Kit Customer L-200	11062634
Frequently used wear and spare parts for self-servicing your device, conveniently gathered in one kit	
Kit Customer nXDS 6iC / 10iC	11062675
Frequently used wear and spare parts for self-servicing your device, conveniently gathered in one kit	

DOMINIQUE DUTSCHER SAS