

Register your instrument!
www.eppendorf.com/myeppendorf



Mechanical Pipette Eppendorf Research[®] plus

Operating Manual

Copyright © 2024 Eppendorf SE, Germany. All rights reserved, including graphics and images. No part of this publication may be reproduced without the prior permission of the copyright owner.

Eppendorf® and the Eppendorf Brand Design are registered trademarks of Eppendorf SE, Germany.

Eppendorf trademarks and trademarks of third parties may appear in this manual. All trademarks are the property of their respective owners. The respective trademark name, representations and listed owners can be found on www.eppendorf.com/ip.

U.S. Patents and U.S. Design Patents are listed on www.eppendorf.com/ip.

Table of contents

1	About this manual.	6
1.1	Notes on this manual.	6
1.2	Warning notice structure.	6
1.3	Graphics.	6
1.4	Other applicable documents.	7
2	Safety.	8
2.1	Intended use.	8
2.2	Residual risks when used as intended.	8
2.2.1	Personal injury.	8
2.2.2	Material damage.	9
2.3	Target groups.	10
2.4	Information for the owner.	10
2.5	Personal protective equipment.	10
2.6	Information on product liability.	11
3	Product description.	12
3.1	Features.	12
3.2	Product overview.	13
3.3	Product components.	15
4	Functional description.	16
4.1	Good pipetting practice.	16
4.2	Optimum immersion depths.	17
5	Installation.	18
5.1	Checking the delivery.	18
6	Operation.	20
6.1	Attaching the pipette tip.	20
6.2	Setting the volume.	21
6.3	Reading the set volume.	22
6.4	Pipetting liquid sample forwards.	22
6.5	Reverse pipetting liquid sample.	23
6.6	Ejecting the pipette tip.	24
6.7	Changing the protection filter.	25
6.8	Storing the pipette.	26
7	Maintenance.	27
7.1	Service.	27
7.1.1	Maintenance plan.	27
7.1.2	Checking the pipette for damage.	27
7.1.3	Disassembling the lower part of the single-channel pipette ≤ 1000 µL.	28

4 Table of contents
Eppendorf Research® plus
English (EN)

7.1.4	Removing the lower part of the single-channel pipette ≥ 2 mL . . .	29
7.1.5	Assembling the lower part of the single-channel pipette $\leq 1000 \mu\text{L}$	31
7.1.6	Assembling the lower part of the single-channel pipette ≥ 2 mL	31
7.1.7	Disassembling the multi-channel lower part – 4.5 mm cone spacing	32
7.1.8	Disassembling the multi-channel lower part $\leq 300 \mu\text{L}$	34
7.1.9	Disassembling the multi-channel lower part $1200 \mu\text{L}$	36
7.1.10	Assembling the multi-channel lower part – 4.5 mm cone spacing	37
7.1.11	Assembling the multi-channel lower part $\leq 300 \mu\text{L}$	38
7.1.12	Assembling the multi-channel lower part $1200 \mu\text{L}$	39
7.1.13	Replacing the o-ring of the multi-channel lower part	40
7.1.14	Greasing the piston and cylinder	41
7.1.15	Calibrating the pipette	42
7.1.16	Adjusting the pipette	42
7.2	Decontamination	43
7.2.1	Suitable cleaning agents and disinfectants	43
7.2.2	Cleaning pipettes	43
7.2.3	Disinfecting the pipette	45
7.2.4	Sterilizing the pipette	47
7.2.5	Autoclaving the pipette	47
8	Troubleshooting	48
8.1	Problems with the pipette	48
8.2	Problems with the pipette tip	48
9	Transport	50
9.1	Shipping the pipette	50
10	Disposal	51
10.1	Preparing for disposal	51
11	Technical data	52
11.1	Adjustable sub-steps	52
11.2	Ambient conditions	53
11.3	Errors of measurement	54
11.4	Test conditions	58
11.5	Materials	59
12	Ordering information	60
12.1	Single-channel pipettes with fixed volume setting	60
12.2	Single-channel pipettes with variable volume setting	60
12.3	Multi-channel pipettes with fixed cone spacing	61

12.4 Pipette tips, accessories and spare parts..... 62

1 About this manual

1.1 Notes on this manual

1. Please read this manual before you use the product.
2. Please ensure that you have the manual available during the use of the product.



You can find the current version of the manual at www.eppendorf.com/manuals.

- Please contact Eppendorf SE to obtain a different version of the manual.

1.2 Warning notice structure



HAZARD LEVEL! Type of danger



Source of danger
Consequences of disregarding the danger

- Measures to avoid the danger

Symbol	Hazard level	Type of danger	Meaning
	DANGER	Personal injury	Will lead to severe injuries or death.
	WARNING	Personal injury	May lead to severe injury or death.
	CAUTION	Personal injury	May lead to minor or moderate injuries.
	NOTE	Material damage	May lead to material damage.

1.3 Graphics

Depiction	Meaning
1.	Work steps
2.	
•	Bullet point
<i>Text</i>	Display text

Depiction	Meaning
Key	Name for port, button, status lamp, or key
	Important information
	Hint

1.4 Other applicable documents

The following documents supplement this manual:

- Chemical resistance for the Eppendorf Research plus pipette
- Adjustment for the Eppendorf Research plus pipette
- Instructions for use for adjustable "Move It" multi-channel lower parts
- "Grease for pipettes" instructions for use
- Standard Testing Procedure For Manual Dispensing Systems

2 Safety

2.1 Intended use

The Eppendorf Research plus pipette is a product for general laboratory use. In combination with the corresponding tips, the pipette is used to transfer liquids in the specified volume range. It is not intended for in vivo use (in or on the human body). The Eppendorf Research plus pipette may only be used by users who have been trained in accordance with the operating manual. Users must read the operating manual carefully and familiarize themselves with how the device works.

2.2 Residual risks when used as intended

If the product is not used as intended, the installed safety devices may not function correctly. To reduce the risk of personal injury and material damage and to avoid dangerous situations, please observe the general safety instructions.

2.2.1 Personal injury

2.2.1.1 Biological hazard

Infectious liquids and pathogenic germs can damage your health.

- Observe the national regulations and the biosafety level of your laboratory.
- Wear personal protective equipment.
- Observe the Safety Data Sheets and instructions for use for the accessories.
- Consult the "Laboratory Biosafety Manual" (source: World Health Organization, Laboratory Biosafety Manual, as amended) for comprehensive regulations on handling of germs or biological material of risk group II or higher.

2.2.1.2 Chemical hazards

Improper pipetting of radioactive, toxic and aggressive liquids can cause serious damage to health.

- Observe the national regulations of your laboratory.
- Wear personal protective equipment.
- Observe the Safety Data Sheets for the accessories.

2.2.1.3 Incorrect handling

If you point the opening of the dispensing device towards yourself or others, persons can be injured.

- Only initiate liquid dispensing if it is safe to do so.
- For all dispensing tasks, make sure that you are not endangering yourself or anyone else.

2.2.2 Material damage

2.2.2.1 Chemical hazards

Aggressive substances may damage components, consumables and accessories.

- Check chemical resistance before using organic solvents and aggressive chemicals.
- Check compatibility with the materials used.
- Only use liquids whose vapors do not attack the materials used.

2.2.2.2 Incorrect handling

The use of accessories and spare parts other than those recommended by Eppendorf SE may impair the safety, functioning, and precision of the device. Eppendorf SE cannot be held liable or accept any liability for damage resulting from the use of accessories and spare parts other than those recommended.

- Only use the accessories and spare parts recommended by Eppendorf SE.
- Only use accessories and spare parts that are in perfect technical condition.

If the pipette tips or the packing are not in perfect condition or are damaged, the pipette and the liquid sample can become contaminated.

- Only use pipette tips that are in perfect condition.
- If the packing is damaged, do not use the pipette tips.

If liquid sample reaches the inside of the pipette, the pipette may become damaged.

- Only pipette with a pipette tip attached.

If you use pipette tips more than once, carry-over, contamination and incorrect dispensing results can occur.

- Only use pipette tips once.

If liquid sample reaches the inside of the pipette, the pipette may become damaged.

- Only immerse the pipette tip when aspirating liquid.
- Do not put down the pipette when the pipette tip is full.

If liquid sample is dispensed when there is a marked difference between temperatures, the dispensing result may be distorted.

- Make sure the pipettes, pipette tips and liquid sample are the same temperature.

The physical properties of non-aqueous solutions may differ significantly from water. When working with non-aqueous solutions, the dispensing result may be distorted.

- Temporarily adjust the pipette to the non-aqueous solution.

2.3 Target groups

This manual is intended for the following target groups, who have different qualifications and levels of knowledge.

Owner

The owner is any natural or legal person who operates or owns the device.

The owner provides the product and the necessary infrastructure. The owner has a special responsibility to ensure the safety of all persons working on the product.

User

The user operates the product and works with it. The user must be instructed in the use of the product. The user must have read and fully understood the manual.

Any tasks that go beyond operation may only be performed by the user if this is specified in this manual. The owner must explicitly assign these tasks to the user.

Authorized service technician

The authorized service technician is trained and certified by Eppendorf SE to service, maintain and repair the product.

2.4 Information for the owner

The owner must ensure the following:

- The product is in a safe operating condition.
- The safety devices are all available and functional.
- The product is serviced and cleaned according to the information in this manual.
- The product is disposed of in accordance with local regulations.
- All work on the product is carried out by users, technical personnel or authorized service technicians who are suitably qualified.
- Personal protective equipment is available and is worn.
- The manual is available during the use of the product.
- The manual is part of the product. The product will only be passed on to others with its manual.

2.5 Personal protective equipment

Personal protective equipment serves to ensure the safety and protection of the user when working with the product.

Personal protective equipment must comply with country-specific regulations and the regulations of the laboratory.

2.6 Information on product liability

The owner of the device will be held liable for personal and material damage in the following cases:

- The device is used outside of its intended use
- The device is not used in accordance with the operating manual
- Manipulation of safety devices
- The device has spare parts installed that are not authorized by Eppendorf SE
- The device is used with accessories or consumables that are not recommended by Eppendorf SE
- Cleaning agents are used that are not recommended by Eppendorf SE
- Chemicals are used that are not recommended by Eppendorf SE
- Shipment not in original packing or in improper substitute packing
- The device is maintained or repaired by persons not authorized by Eppendorf SE
- Unauthorized modifications

Product description

Eppendorf Research® plus
English (EN)

3 Product description**3.1 Features**

The pipette has the following features:

- Mechanical piston-stroke pipette using the air-cushion principle
- Volume identification supported by color codes
- Fixed and variable volume setting
- Volume setting ring
- Volume display window
- Separate ejector button
- White separator marks the decimal place
- Two-button operation
- Minimal force required for attaching and ejecting pipette tips
- High chemical resistance

The following variants are available:

- Single-channel pipettes with fixed volume setting
- Single-channel pipettes with variable volume setting
- Multi-channel pipettes with 8 or 12 channels with fixed cone spacing (9 mm) and variable volume setting
- Multi-channel pipettes with 16 or 24 channels with fixed cone spacing (4.5 mm) and variable volume setting
- Multi-channel pipettes with 4, 6, 8 or 12 channels with adjustable cone spacing (4.5 mm – 33 mm) and variable volume setting

3.2 Product overview

Single-channel pipette and multi-channel pipette

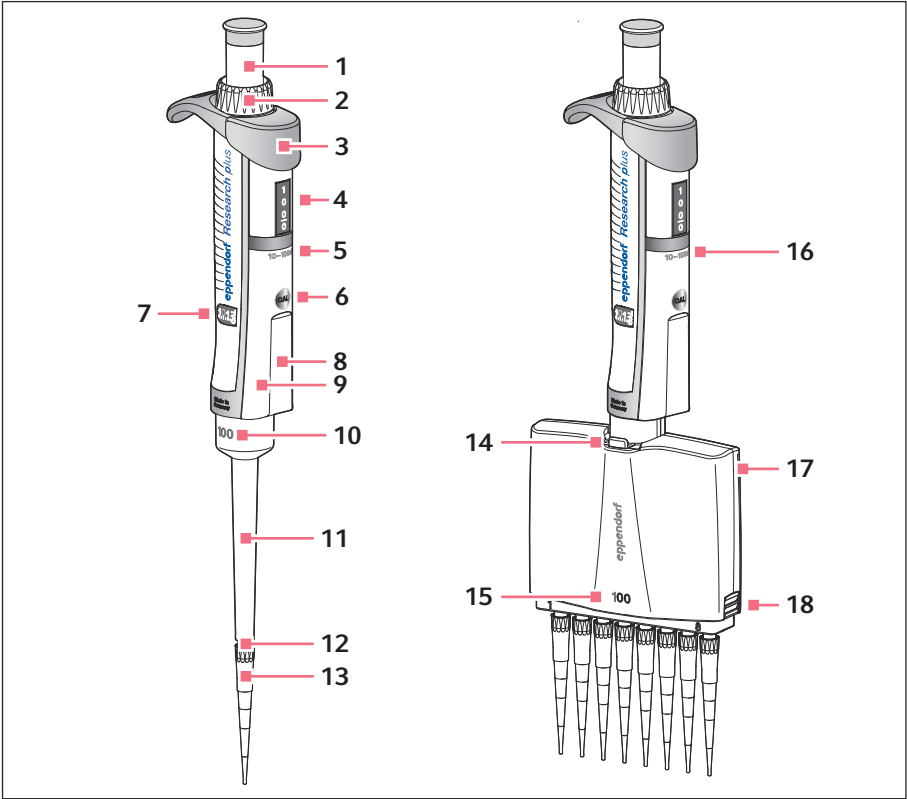

Fig. 3-1: Single-channel pipette and multi-channel pipette

Product description

Eppendorf Research® plus
English (EN)

- | | | | |
|---|---|----|---|
| 1 | Control button | 10 | Single-channel lower part with nominal volume |
| 2 | Volume setting ring | 11 | Ejector sleeve |
| 3 | Ejector button | 12 | Tip cone |
| 4 | Volume display | 13 | Pipette tip |
| 5 | Single-channel upper part with nominal volume | 14 | Lever |
| 6 | Adjustment opening | 15 | Multi-channel lower part with nominal volume |
| 7 | Adjustment display | 16 | Multi-channel upper part with nominal volume |
| 8 | Labeling area | 17 | Housing lid |
| 9 | RFID chip | 18 | Latch for opening the lower part |

Multi-channel lower parts with fixed cone spacing

Fig. 3-2: Multi-channel lower parts with fixed cone spacing

- | | | | |
|---|---|---|--|
| 1 | Mechanical coupling | 4 | 16-channel lower part, 4.5 mm cone spacing for 384-well plates |
| 2 | 8-channel lower part, 9 mm cone spacing for 96-well plates | 5 | 24-channel lower part, 4.5 mm cone spacing for 384-well plates |
| 3 | 12-channel lower part, 9 mm cone spacing for 96-well plates | | |

3.3 Product components

Color coding

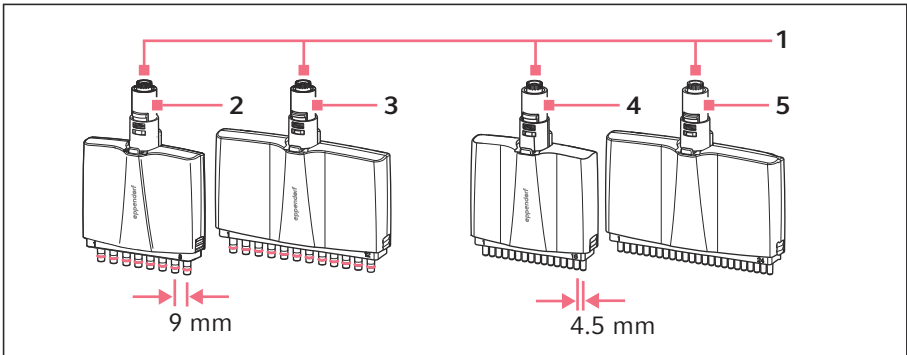
Every nominal volume of the pipette is color-coded. The corresponding pipette tips are marked with the same color code.

Ejector

When the ejector button is pressed, it pushes the ejector sleeve downwards and ejects the pipette tip.

Volume display

The four-digit counter shows the set volume. The white separator on the volume display marks the decimal place. The volume is read from top to bottom.

Control button

The control button is used to carry out the following functions:

- Liquid aspiration
- Liquid dispensing

Volume setting ring

The volume setting ring is used to adjust the desired pipetting volume on the four-digit volume display.

Adjustment seal

The color of the *ADJ* adjustment seal indicates whether the factory setting is set or a temporary adjustment has been made by the user.

- Gray adjustment seal: factory setting
- Red adjustment seal: temporary adjustment

Adjustment display

Temporary changes can be made to the pipette adjustment. The viewing window of the adjustment display shows a scale of -8 to +8. The value 0 indicates factory settings.

Functional description

Eppendorf Research® plus
English (EN)

4 Functional description**Air-cushion principle**

With piston-stroke pipettes, a cushion of air separates the piston from the liquid sample. The air cushion is moved by the piston and ensures the liquid is aspirated and dispensed.

Forward pipetting

Forward pipetting is the standard procedure for aspirating and dispensing liquid. The aspirated sample volume corresponds to the dispensing volume.

Reverse pipetting

An additional volume is aspirated when performing reverse pipetting. This can improve dispensing results for viscous or foaming liquid samples. The additional volume is not part of the dispensing volume.

Adjustment

An adjustment is an active change to the dispensing volume of a pipette. The dispensing volume is changed across the entire volume range of the pipette by approximately the same amount.

An adjustment may be necessary in order to adapt the pipette to the following conditions:

- Changed atmospheric pressure on-site
- Non-aqueous solutions with a density, viscosity, surface tension or vapor pressure that deviates from water
- Use of special pipette tips (e.g. long pipette tips)

4.1 Good pipetting practice**Volume setting**

Set the volume from a high to a low value. If necessary, increase the volume beyond the preferred setting and then lower it again.

Pipette selection

Select a pipette with a nominal volume close to the preferred dispensing volume. This will reduce any pipetting inaccuracies.

Presaturation

Presaturate the air cushion in the pipette tip with the liquid sample. The presaturation reduces evaporation and increases the precision and accuracy of the dispensed volume.

Decreasing filling level in sample tube

In order to prevent an absorption of air and splashing of liquids in the tip cone, follow the filling level when removing liquid from narrow tubes.

4.2 Optimum immersion depths

Pipette volume	Immersion depth in liquid
0.1 µL – 1 µL	1 mm
1 µL – 100 µL	2 mm – 3 mm
100 µL – 1000 µL	2 mm – 4 mm
1 mL – 10 mL	3 mm – 5 mm

5 Installation**5.1 Checking the delivery**

Do not use the product if the packing or the contents are damaged. In case of damaged or missing parts, contact the Eppendorf SE customer service or your Eppendorf partner.

1. Check the packing and the contents for any visible external damage.
2. Check whether the delivery is complete and matches the order.

Quantity	Description
1	Piston-stroke pipette
1	Adjustment tool with blue handle
5	Red adjustment seal for temporary adjustment
1	Pin for removing the safety plug
1	Grease for pipettes
1	Operating manual
1	Certificate of conformity

Accessories for single-channel pipettes

Quantity	Description
1	Locking ring for $\leq 1000 \mu\text{L}$
10	Protection filter for 2.5 mL – 10 mL
1	Pipette wrench for 2.5 mL – 10 mL

Accessories for multi-channel pipettes

Quantity	Description
1	Multi-channel tool for 100 µL and 300 µL
1	Multi-channel tool for 1200 µL
1	Unlocking tool for 1200 µL
2	Locking clip for 8-channel lower parts
3	Locking clip for 12-channel lower parts

6 Operation

6.1 Attaching the pipette tip

The control button on the pipette and the Trays are color-coded. The color indicates the corresponding pipette and the volume of the pipette tips (epT.I.P.S.).

Depending on the pipetting volume, the use of extra-long pipette tips can have an adverse effect on the accuracy and correctness of dispensing compared to regular-length pipette tips.

The adjustment must be adjusted for the following pipette tips:

- epT.I.P.S. 50 - 1250 μ L L, dark green, 103 mm
- epT.I.P.S. 0.2 - 5 mL L, violet, 175 mm
- epT.I.P.S. 0.5 - 10 mL L, turquoise, 243 mm

Attaching pipette tips to single-channel pipettes



With spring-loaded tip cones, the tip cone must be pressed into the pipette tip until the edge of the pipette tip touches the ejector of the pipette. This is the only way to ensure that the pipette tip sits firmly and tightly on the tip cone.

Prerequisites:

- A single-channel pipette suitable for the pipette tip is available.

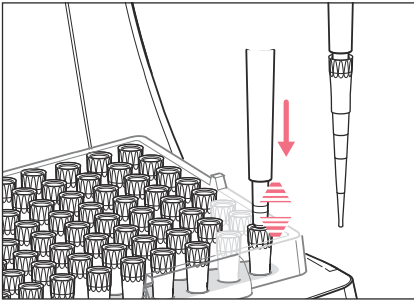

1. Open the lid by pressing the release button.
2. Insert the tip cone of the pipette by lowering it vertically into the pipette tip using firm pressure.

The connection between tip cone and pipette tip must be sufficiently strong to ensure the dispensing results are not affected.

3. After removing the pipette tip, close the box to protect the other pipette tips.

Attaching pipette tips to multi-channel pipettes

- i** With spring-loaded tip cones, the tip cone must be pressed into the pipette tip until the edge of the pipette tip touches the ejector of the pipette. This is the only way to ensure that the pipette tip sits firmly and tightly on the tip cone.

Prerequisites:

- A multi-channel pipette suitable for the pipette tips is available.

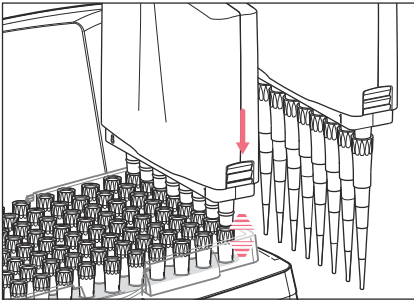

1. Open the lid by pressing the release button.
2. Insert the tip cones of the pipette by lowering them vertically, without any sideways movement, into the pipette tips using firm pressure.

The connection between tip cone and pipette tip must be sufficiently strong to ensure the dispensing results are not affected.

3. After removing the pipette tips, close the box to protect the other pipette tips.

6.2 Setting the volume

Setting a small volume

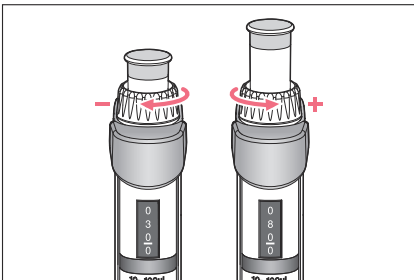

1. Adjust the volume from high to low by turning the volume setting ring clockwise.

Setting a large volume

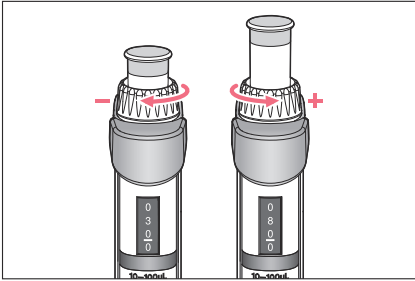

1. Adjust the volume from high to low by turning the volume setting ring counter-clockwise.

6.3 Reading the set volume

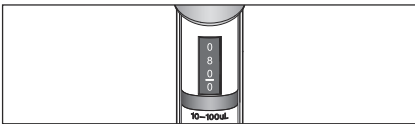

1. Read the set volume in the volume display from top to bottom. The white separator marks the decimal place.

Example

The set volume is 80 µL.

6.4 Pipetting liquid sample forwards

Aspirating liquid sample



For maximum precision and accuracy, presaturate the air cushion in the pipette tip by aspirating and dispensing the liquid sample one to three times.

Prerequisites:

- The pipette tip has been attached.
- The volume has been set.
- A source vessel with liquid sample is available.

1. Press the control button down to the first stop.
2. Immerse the pipette tip vertically into the liquid sample.
3. Maintain the immersion depth and allow the control button to slide back slowly. The liquid sample is aspirated into the pipette tip.
4. Wait until the liquid sample has been aspirated.

5. Remove the pipette tip out of the liquid sample.
6. If necessary, wipe the pipette tip against the tube inner wall.

Dispensing liquid sample

Prerequisites:

- The liquid sample has been aspirated.
 - A destination vessel is available.
1. Place the pipette tip steeply against the tube inner wall.
 2. Slowly press the control button down to the first stop.
The liquid sample is dispensed.
 3. Wait until the flow of liquid sample stops.
 4. Press the control button down to the second stop.
The pipette tip is completely emptied.
 5. Press and hold the control button and wipe the pipette tip on the tube inner wall.

6.5 Reverse pipetting liquid sample



Volume limits may occur when using filter tips.

Aspirating liquid sample

Prerequisites:

- The pipette tip has been attached.
 - The volume has been set.
 - A source vessel with liquid sample is available.
1. Keep pressing down the control button until it is stopped again.
 2. Immerse the pipette tip vertically in the liquid sample.
 3. Maintain the immersion depth and allow the control button to slide back slowly.
The liquid sample is aspirated into the pipette tip.
 4. Wait until the liquid sample has been aspirated.
 5. Pull the pipette tip out of the liquid sample.
 6. If necessary, wipe the pipette tip against the tube wall.

Operation

Eppendorf Research® plus
English (EN)

Dispensing liquid sample

The additional volume is not part of the dispensing volume.

Prerequisites:

- The liquid sample has been aspirated.
- A destination vessel is available.

1. Place the pipette tip at a sharp angle to the tube wall.
2. Slowly press the control button down until it meets resistance.
The liquid sample is dispensed.
3. Wait until the flow of liquid sample stops.
4. Press and hold the control button and wipe the pipette tip on the tube wall.
Residual liquid from the additional volume remains in the pipette tip.

6.6 Ejecting the pipette tip**Discarding the pipette tip when forward pipetting**

1. Press the ejector button.
The pipette tip has been ejected.

Discarding the pipette tip when reverse pipetting

Prerequisites:

- A waste container is available.
1. Keep pressing down the control button until it meets resistance again.
The residual liquid from the additional volume is ejected and can be discarded.
 2. Press the ejector button.
The pipette tip is ejected.

6.7 Changing the protection filter

Valid for the following volumes:

- 2.5 mL
- 5 mL
- 10 mL

The protection filter in the tip cone must be replaced every time it comes into contact with liquid.

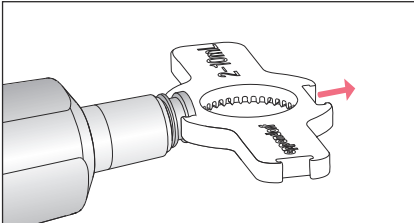

1. Push the pipette wrench with the correct recess onto the filter sleeve.
2. Pull out the filter sleeve.

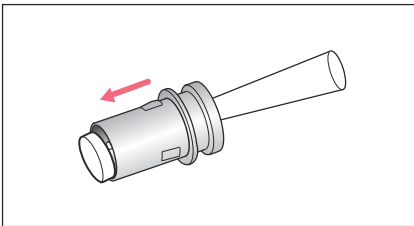

3. Use a pipette tip to push out the used protection filter.
4. Clean the filter sleeve.

26 **Operation**
Eppendorf Research® plus
English (EN)

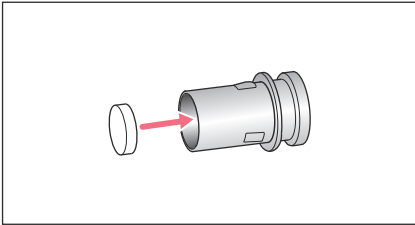

5. Insert the new protection filter into the filter sleeve.

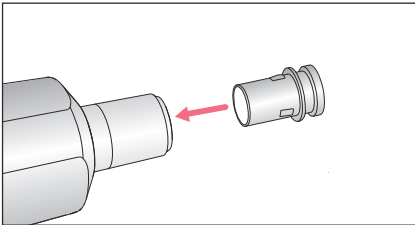

6. Insert the filter sleeve into the tip cone.

6.8 Storing the pipette

Prerequisites:

- The pipette tip has been ejected.

1. Store the pipette correctly:
 - in the pipette carousel
 - in the wall mount
 - in a horizontal position

7 Maintenance

7.1 Service

Eppendorf SE recommends having your device inspected and maintained at regular intervals by trained and skilled personnel.

Eppendorf SE offers customized service solutions for preventive maintenance, qualification and calibration of your device. For information, offers and contact options, visit our website www.eppendorf.com/epservices.

7.1.1 Maintenance plan

Interval	Maintenance work
As required	↳ Chapter 7.1.13 "Replacing the o-ring of the multi-channel lower part" on page 40
	↳ Chapter 7.1.16 "Adjusting the pipette" on page 42
	↳ "Cleaning the pipette upper part and pipette lower part" on page 44
	↳ Chapter 7.2.2 "Cleaning pipettes" on page 43
	↳ Chapter 7.2.3 "Disinfecting the pipette" on page 45
	↳ Chapter 7.2.4 "Sterilizing the pipette" on page 47
	↳ Chapter 7.2.5 "Autoclaving the pipette" on page 47
Daily	↳ Chapter 7.1.2 "Checking the pipette for damage" on page 27
Yearly	↳ Chapter 7.1.15 "Calibrating the pipette" on page 42

7.1.2 Checking the pipette for damage

1. Check whether the pipette is damaged on the outside.
If the pipette is damaged on the outside, stop using it.
2. Check whether the pipette is free of contamination.
If the pipette is contaminated, clean it.

7.1.3 Disassembling the lower part of the single-channel pipette ≤ 1000 µL

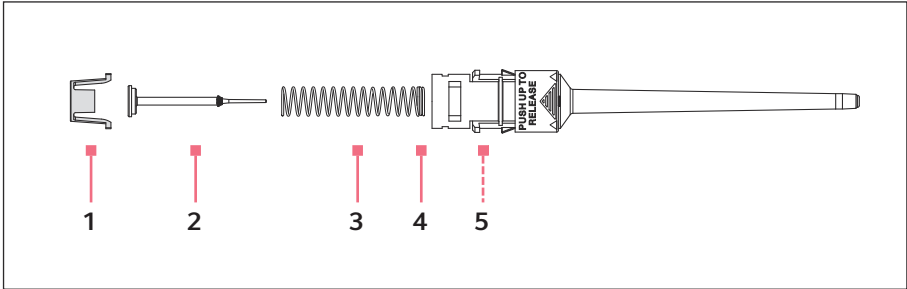
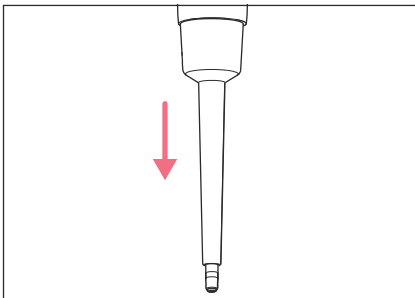
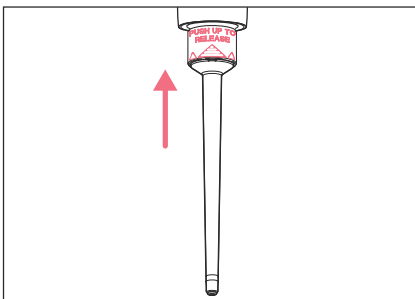

Fig. 7-1: Lower part of the single-channel pipette ≤ 1000 µL

- | | | | |
|---|---------------|---|----------------|
| 1 | Piston mount | 4 | Double coil |
| 2 | Piston | 5 | Inner cylinder |
| 3 | Piston spring | | |



1. Press down the ejector button completely and keep it there.
2. Pull off the ejector sleeve.
3. Release the control button.



4. Push the ring labeled *PUSH UP TO RELEASE* up until the lower part is released.

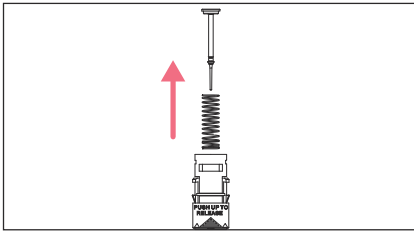
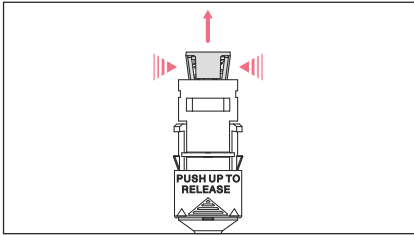

5. Remove the lower part from the upper part.

i The piston is under spring tension.

6. Gently press together the tabs on the piston mount.

7. Remove the piston mount.

i With the 1000 μL pipette (color code blue), the piston spring is firmly attached to the piston.

8. Remove the piston and the piston spring.

7.1.4 Removing the lower part of the single-channel pipette ≥ 2 mL

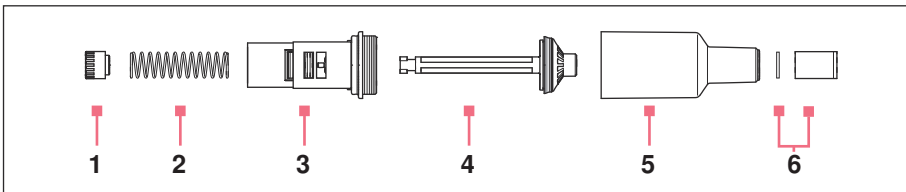

Fig. 7-2: Lower part of single-channel pipette ≥ 2 mL

1 Piston mount

2 Piston spring

3 Piston guide

4 Piston

5 Cylinder with tip cone

6 Filter sleeve and protection filter

Tool:

- Pipette wrench

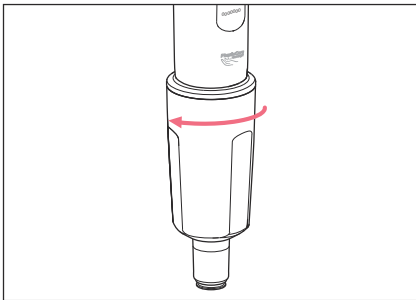

1. Unscrew the ejector sleeve.

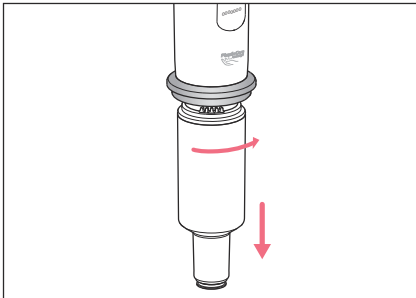

2. Press and hold the ejector button and turn the lower part approx. 30° to the right.

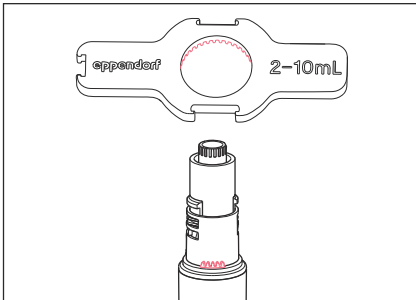

3. Place the pipette wrench on the lower part.
4. Keep hold of the cylinder and unscrew it from the lower part.

7.1.5 Assembling the lower part of the single-channel pipette ≤ 1000 µL



For piston springs with double coils, these coils must point downwards.

1. Carefully guide the piston and the piston spring into the cylinder.
Make sure that the piston is guided correctly in the piston spring and the cylinder.
There must not be any perceptible resistance.
If you meet with resistance, then the piston is not correctly positioned in the cylinder.
There is a risk of bending the piston if too much force is applied.
Carefully retract the piston and repeat the process.
2. Press and hold the piston and the piston spring.
3. Hold the stop pins pressed on the piston mount with the other hand.
4. Attach the piston mount so that the two stop pins engage in their retainers.
5. Gently press a pipette tip against the inserted piston.
The piston must move down in the cylinder without any noticeable resistance.
6. Insert the pre-assembled lower part of the pipette into the upper part until it audibly engages.
7. Press and hold the ejector button and attach the ejector sleeve.
If correctly fitted, it will audibly engage.
8. To ensure the pipette has been correctly assembled, check to see that it works.
9. Check the systematic and random errors using the standard operating procedure for manual dispensing devices.

7.1.6 Assembling the lower part of the single-channel pipette ≥ 2 mL

1. Insert the piston into the piston guide.
2. Insert the piston spring into the piston guide.
3. Attach the piston mount and press the piston spring into the piston guide.
4. Rotate the piston mount 90° and allow it to engage.
5. Insert the pre-assembled lower part of the pipette into the upper part until it audibly engages.
6. Attach the ejector sleeve and screw it on tightly.

7. To ensure the pipette has been correctly assembled, check to see that it works.
8. Check the systematic and random errors using the standard operating procedure for manual dispensing devices.

7.1.7 Disassembling the multi-channel lower part – 4.5 mm cone spacing

Prerequisites:

- The lower part has been removed from the pipette upper part.

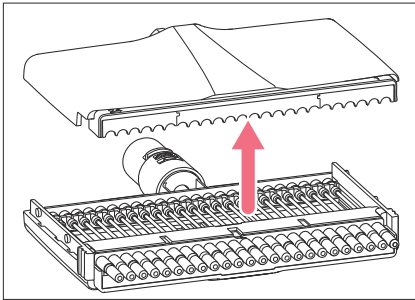

1. Push both latches on the lower part down.
2. Remove the front housing lid.

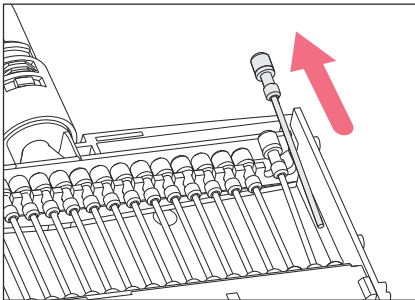

3. Lift the piston out of the piston mounting and pull it out of the cylinder.

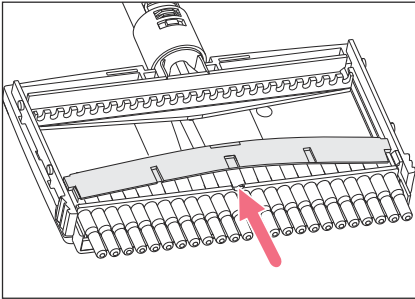

4. Lift the clamping strip in the middle and remove it.

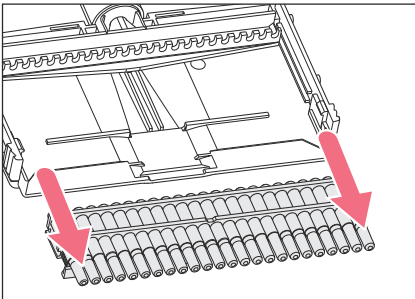

5. Slide the cylinder block parallel downwards out of the housing case.
The lower part can be cleaned.

7.1.8 Disassembling the multi-channel lower part ≤ 300 µL



NOTICE! Damage to components

If the piston is jammed while being pulled out, the piston may break.

- Pull the piston straight out of the tip cone.

Valid for 8-channel and 12-channel lower parts with 9 mm cone spacing:

- 10 µL
- 100 µL
- 300 µL

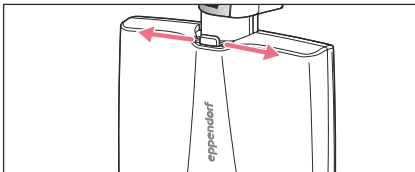

1. To unlock the lower part, slide the lever to the left or right.
2. Pull off the lower part.

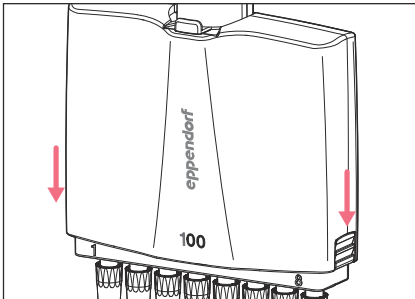

3. Hold the bottom part so that the lever points toward the palm of your hand.
4. Push the left and right latches up.
5. Remove the front lid with integrated ejector.

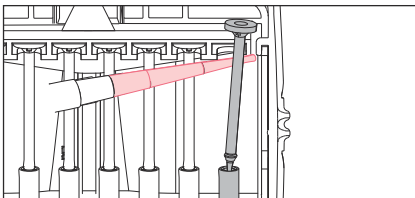

6. Carefully release the piston from the upper rail and pull the piston upwards.
7. Remove the sealing washer from the piston.

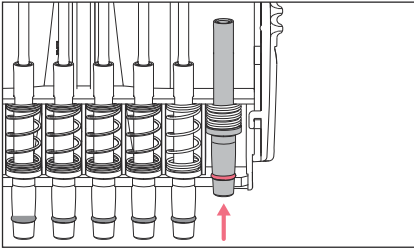

8. Press the tip cone into the rear lid so that the spring is completely compressed.

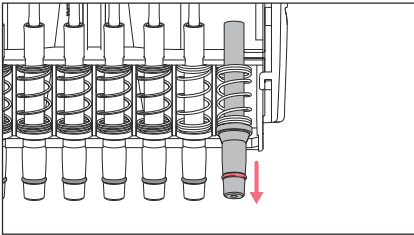

9. Lift the tip cone with spring forward.
10. Remove the tip cone with spring completely towards the front.

7.1.9 Disassembling the multi-channel lower part 1200 µL

Valid for 8-channel and 12-channel lower parts with 9 mm cone spacing:

- 1200 µL

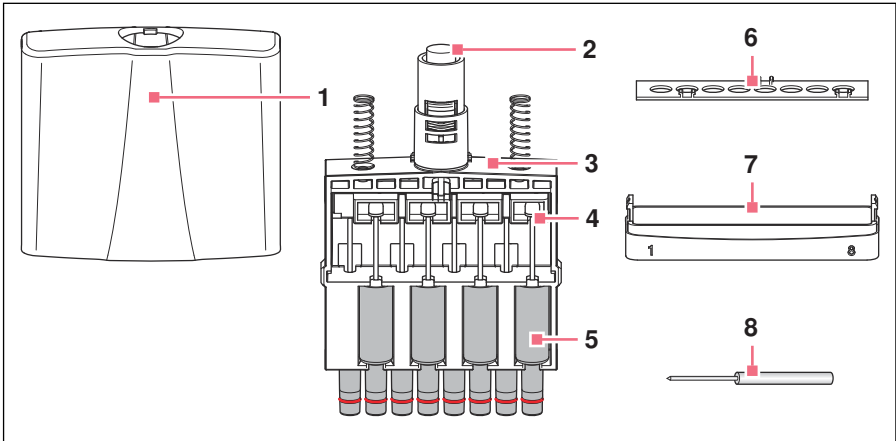

Fig. 7-3: Multi-channel lower part 1200 µL

- | | | | |
|---|--------------------|---|----------------------|
| 1 | Housing case | 5 | Cylinder with o-ring |
| 2 | Piston actuator | 6 | Fixing strip |
| 3 | Housing inner part | 7 | Ejector |
| 4 | Piston | 8 | Unlocking tool |

Tool:

- Unlocking tool

1. To unlock the lower part, press the ejector button. Move the lower part to the left or to the right.
2. Remove the lower part from the upper part.
The ejector coupling is in the upper part.
3. The ejector is attached to the housing case with 2 hooks. To release the hook on the left side, insert the unlocking tool from below into the left hole of the ejector.
4. Keep the housing case open.
5. Release the hook on the right-hand side. To do this, insert the unlocking tool from below into the right hole of the ejector.

6. Remove the ejector.
7. Pull off the housing case upwards.
8. Remove the fixing strip.
The fixing strip is snapped into place at 3 points. No tools are required to release it.
9. Push the piston mount down.
10. Remove the piston with cylinder and the o-ring.
11. Remove the piston from the cylinder.
12. Remove the sealing washer from the piston.

7.1.10 Assembling the multi-channel lower part – 4.5 mm cone spacing

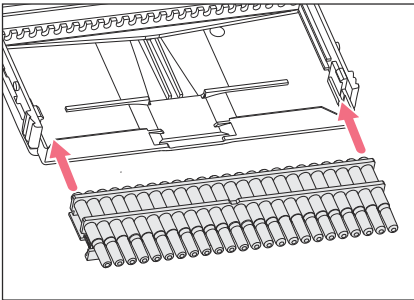

1. Insert the cylinder block parallel into the housing case.
2. Push the cylinder block parallel into the housing case.
The cylinder block fits flush with the edge of the housing case.

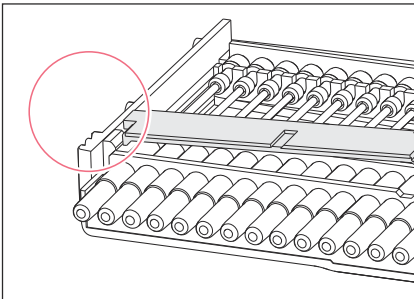

3. Insert the clamping strip on one side under the plastic tab in the housing case.
4. Bend the clamping strip and insert it on the other side.
The cylinder block is fixed in place.

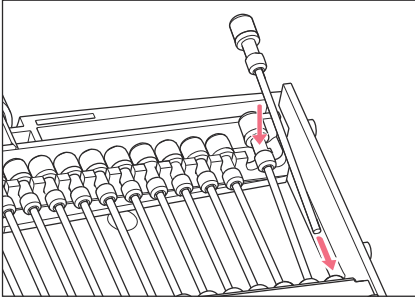

5. Push the piston into the cylinder.
6. Insert the piston end into the piston mounting.

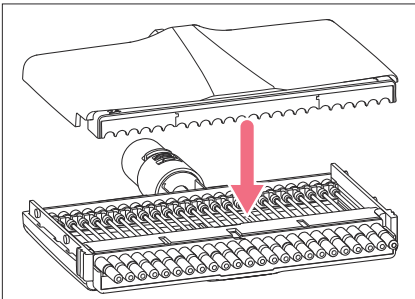

7. Replace the housing lid.
8. Slide both side latches on the lower part upwards.
9. To ensure the pipette has been correctly assembled, check to see that it works.
10. Check the systematic and random errors using the Standard Testing Procedure For Manual Dispensing Systems.

7.1.11 Assembling the multi-channel lower part $\leq 300 \mu\text{L}$

Valid for 8-channel and 12-channel lower parts with 9 mm cone spacing:

- 10 μL
- 100 μL
- 300 μL

1. Insert the cylinder with spring against the middle rail.
2. Compress the spring with the cylinder.
3. Insert the cylinder into the lower rail.
4. Insert the piston into the cylinder.
5. Insert the piston into the upper rail.
6. Replace the cover plate.
7. Slide both latches upwards.
The lid is locked.
8. Insert the lower part into the upper part until an audible click is heard.

9. To ensure the pipette has been correctly assembled, check to see that it works.
10. Check the systematic and random errors using the Standard Testing Procedure For Manual Dispensing Systems.

7.1.12 Assembling the multi-channel lower part 1200 µL

Valid for 8- and 12-channel lower parts with 9 mm cone spacing:

- 1200 µL
1. Assemble the lower part in reverse order.
Attach the housing case in such a way that the toothed rings in the housing case and the toothed rings on the interior part of the housing do not overlap.
 2. To ensure the pipette has been correctly assembled, check to see that it works.
 3. Check the systematic and random errors using the standard operating procedure for manual dispensing devices.

7.1.13 Replacing the o-ring of the multi-channel lower part

Worn or damaged o-rings must be replaced.

Valid for the multi-channel lower parts:

- 100 µL
- 300 µL
- 1200 µL

Removing the o-ring

Tool:

- Multi-channel tool 100/300
- Multi-channel tool 1200

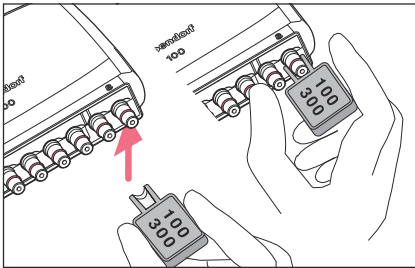

1. Guide the multi-channel tool with the opening to the tip cone.
2. Press the multi-channel tool against the tip cone and use your thumb to hold it. The o-ring is cut.
3. Remove the multi-channel tool and the o-ring.

Fitting the o-ring 100 µL – 300 µL

Tool:

- Mounting aid

1. Place the mounting aid onto the tip cone.
2. Slide the o-ring over the mounting aid onto the tip cone. The o-ring sits in the groove of the tip cone.
3. Remove the mounting aid.
4. Attach the pipette tip.
5. Check that the pipette tip is firmly seated and leak tight.

Fitting the o-ring 1200 µL

1. Slide the o-ring onto the tip cone. The o-ring sits in the groove of the tip cone.

2. Attach the pipette tip.
3. Check that the pipette tip is firmly seated and leak tight.

7.1.14 Greasing the piston and cylinder

The piston or cylinder in the pipette lower part must be regreased after cleaning or decontamination.

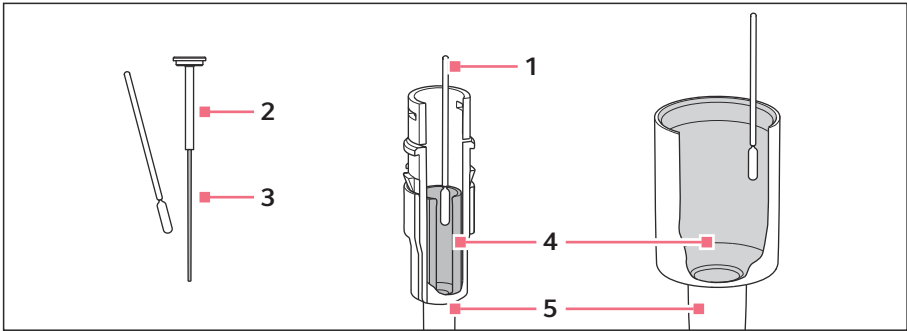

Fig. 7-4: Greasing the piston and cylinder

- | | | | |
|---|------------------------------|---|-------------------------------|
| 1 | Swab | 4 | Cylinder |
| 2 | Piston $\leq 20 \mu\text{L}$ | 5 | Lower part $> 20 \mu\text{L}$ |
| 3 | Running surface | | |

Greasing the piston

Prerequisites:

- For volumes $\leq 20 \mu\text{L}$
- The pipette lower part has been disassembled.

1. Apply a small amount of grease to the swab.
2. Apply a thin layer of grease to the piston running surface.
The pipette lower part can be reassembled.

Maintenance

Eppendorf Research® plus
English (EN)

Greasing the cylinder

Prerequisites:

- For volumes > 20 µL
- The pipette lower part has been disassembled.

1. Apply a small amount of grease to the swab.
2. Apply a thin layer of grease to the inside wall of the cylinder.
The pipette lower part can be reassembled.

7.1.15 Calibrating the pipette**Shipping the pipette to a calibration laboratory**

1. Have the pipette calibrated in accordance with DIN EN ISO 8655.

Calibrating the pipette yourself

1. Calibrate the pipette in accordance with DIN EN ISO 8655 using the standard operating procedure for manual dispensing devices.

7.1.16 Adjusting the pipette

1. Adjust the pipette using the Adjustment for the Eppendorf Research plus pipette document.

7.2 Decontamination

7.2.1 Suitable cleaning agents and disinfectants

In the tables you will find suitable cleaning agents and disinfectants for various types of contamination.

Cleaning agents

Contamination	Suitable cleaning agents
Water-soluble contamination: <ul style="list-style-type: none"> • Acids • Alkalis • Saline solutions 	<ul style="list-style-type: none"> • Deionized water
Molecular biological contamination: <ul style="list-style-type: none"> • Nucleic acids 	<ul style="list-style-type: none"> • DNA/RNA cleaning agent • Sodium hypochlorite, maximum 4 %
Biochemical contamination: <ul style="list-style-type: none"> • Proteins 	<ul style="list-style-type: none"> • Mild detergent

Disinfectants

Contamination	Suitable disinfectants
<ul style="list-style-type: none"> • Infectious liquids • Microorganisms 	<ul style="list-style-type: none"> • Ethanol 70 % • Isopropanol • Meliseptol

7.2.2 Cleaning pipettes

Clean the outside of the pipette regularly to remove visible and non-visible contamination. The pipette upper parts are cleaned on the outside. The pipette lower parts can be cleaned from the outside and rinsed from the inside.

The pipette must be cleaned in the following cases:

- If it is dirty
- If aggressive chemicals are used
- If it is subjected to heavy use

Cleaning the pipette upper part and pipette lower part

**NOTICE! Damage to the device and accessories**

The use of unsuitable cleaning agents or sharp objects may damage the device and its accessories.

- Do not use any aggressive cleaning agents, strong solvents or abrasive polishes.
- Check the compatibility with the materials used.
- Do not clean the device with acetone or organic solvents with a similar effect.
- Do not use any sharp or pointed objects to clean the device.

Material:

- Suitable cleaning agent
 - Deionized water
 - Cloth
1. Dampen the cloth with a suitable cleaning agent.
 2. Wipe the outside of the pipette.
 3. Dampen a new cloth with deionized water.
 4. Wipe off any cleaning agent residue from the pipette.
 5. Allow the pipette to air dry or place the pipette in a drying cabinet at a maximum of 60 °C.

Rinsing the pipette lower part with cleaning agent

The pipette lower part must be rinsed in the following cases:

- Liquid has been drawn into the inside of the pipette.
- Aerosols have entered the inside of the pipette.

**NOTICE! Damage to the device and accessories**

The use of unsuitable cleaning agents or sharp objects may damage the device and its accessories.

- Do not use any aggressive cleaning agents, strong solvents or abrasive polishes.
- Check the compatibility with the materials used.
- Do not clean the device with acetone or organic solvents with a similar effect.
- Do not use any sharp or pointed objects to clean the device.

Material:

- Suitable cleaning agent
- Deionized water
- Cloth

Prerequisites:

- The pipette lower part has been separated from the pipette upper part.
 - The pipette lower part has been disassembled.
1. Check the pipette lower part for wear and damage.
 2. Replace defective components.
 3. Remove the piston grease from the piston and from the cylinder wall.
 4. Rinse the components of the pipette lower part with a suitable cleaning agent.
 5. Rinse the components of the pipette lower part thoroughly with deionized water.
 6. Allow the components of the pipette lower part to air dry or place the components in a drying cabinet at a maximum of 60 °C.
 7. Regrease the piston and cylinder wall.
 8. Reassemble the pipette lower part.

7.2.3 Disinfecting the pipette

The pipette upper parts are only disinfected on the outside. The pipette lower parts can be disinfected from the outside and inside.

The pipette must be disinfected in the following cases:

- If it comes into contact with infectious liquids.



NOTICE! Damage to the device and accessories

The use of unsuitable cleaning agents or sharp objects may damage the device and its accessories.

- Do not use any aggressive cleaning agents, strong solvents or abrasive polishes.
- Check the compatibility with the materials used.
- Do not clean the device with acetone or organic solvents with a similar effect.
- Do not use any sharp or pointed objects to clean the device.

Disinfecting the outside of the pipette upper part and pipette lower part

Material:

- Suitable disinfectant
- Deionized water
- Cloth

Prerequisites:

- All cleaning agent residues have been removed.
1. Dampen the cloth with a suitable disinfectant.
 2. Wipe the outside of the pipette.
 3. Dampen a new cloth with deionized water.
 4. Wipe off any disinfectant residue from the pipette.
 5. Allow the pipette to air dry or place the pipette in a drying cabinet at a maximum of 60 °C.

Rinsing the pipette lower part with disinfectant

Material:

- Suitable disinfectant
- Deionized water

Prerequisites:

- The pipette lower part has been separated from the pipette upper part.
 - The pipette lower part has been disassembled.
 - All cleaning agent residues have been removed.
 - Contamination caused by liquid that has penetrated has been removed.
1. Check the pipette lower part for wear and damage.
 2. Replace defective components.
 3. Remove the piston grease from the piston and from the cylinder wall.
 4. Rinse the components of the pipette lower part with a suitable disinfectant or place the components in the disinfectant.
 5. Allow the disinfectant to take effect according to the manufacturer's instructions.
 6. Rinse the components of the pipette lower part thoroughly with deionized water.
 7. Allow the components of the pipette lower part to air dry or place the components in a drying cabinet at a maximum of 60 °C.

8. Regrease the piston and cylinder wall.
9. Reassemble the pipette lower part.

7.2.4 Sterilizing the pipette

Treatment with UV light deactivates microorganisms on the outer surface of the pipette. Typically, a UV lamp is used in a biosafety cabinet.

Material:

- UV lamp
1. Sterilize the pipette with UV light at 254 nm and a distance of 60 cm.

7.2.5 Autoclaving the pipette



NOTICE! Material damage

If disinfectant, decontamination agent, Sodium hypochlorite or UV irradiation is used directly before autoclaving, the surface and material of the pipette may become damaged and porous.

- Wipe away any remaining disinfectant or decontamination agent from the pipette using deionized water.
- Do not use any additional disinfectant or decontamination agent with the autoclave.



The piston does not need to be greased again after autoclaving.

Prerequisites:

- The pipette has been cleaned.
 - All cleaning agent or disinfectant residues have been removed.
 - The protection filter for the pipettes 2 mL – 10 mL has been removed.
1. Autoclave the pipette for 20 min at 121 °C and 1 bar positive pressure.
 2. Autoclave the filter sleeve and the protection filter separately.
 3. Cool the pipette to ambient temperature and let it dry.



For the highest possible precision and accuracy, a gravimetric test is recommended after autoclaving.

8 Troubleshooting**8.1 Problems with the pipette**

Error description	Cause	Solution
The adjustment seal has been removed and the adjustment display has changed.	The pipette has been adjusted for a different liquid sample.	Adjust the pipette for the liquid sample used.
The control button is stuck.	The piston or the seal is contaminated.	Clean the lower part.
	The seal is defective.	Replace the seal.
	The pipette is clogged.	Replace the protection filter (2.5 mL – 10 mL).
There is no spring movement in the tip cone of the single-channel pipette.	The spring-loading action is blocked.	Remove the locking ring of the single-channel pipette.
	A 2.5 mL, 5 mL, 10 mL or 1200 µL pipette is used.	The tip cone of these sizes do not have spring-loading action.
There is no spring movement in the tip cones of the multi-channel pipette.	The spring-loading action is blocked.	Remove the locking clip of the multi-channel pipette.

8.2 Problems with the pipette tip

Error description	Cause	Solution
The pipette tip is not firmly attached.	The pipette tip is not compatible.	Use the epT.I.P.S. pipette tips in the correct size.
	A greater attachment force is required.	Firmly attach the pipette tip. Disable the spring-loading action.
The liquid is dripping from the pipette tip.	The pipette tip is not firmly attached.	Firmly attach the pipette tip. Disable the spring-loading action.

Error description	Cause	Solution
The liquid is dripping from the pipette tip.	The pipette tip is not firmly attached.	Use the epT.I.P.S. pipette tips in the correct size. If using the ep Dualfilter T.I.P.S. pipette tips, remove the protective filter in the pipette.
	The piston is contaminated.	Clean and grease the piston.
	The piston is damaged.	Replace the piston.
	The seal is defective.	Replace the seal.
	The o-ring is defective.	Replace the o-ring.
	The dispensed liquid sample has a high vapor pressure.	Presaturate the pipette tip several times.
	The tip cone is damaged.	Replace the lower part of the single-channel pipette. Replace the channel of the multi-channel pipette.
The dispensing volume is faulty.	The dispensed liquid sample has a high vapor pressure or a different density.	Adjust the pipette for the liquid sample used.

9 Transport

9.1 Shipping the pipette

**WARNING! Contamination**

Shipping or storing a contaminated pipette may lead to contamination of persons or cause damage to health.

- Clean and decontaminate the pipette before shipping it or putting it into storage.

Prerequisites:

- The pipette has been cleaned and decontaminated.
1. Download the decontamination certificate for returning goods from www.eppendorf.com.
 2. Fill out the decontamination certificate.
 3. Pack the pipette securely against shocks.
 4. Attach the decontamination certificate to the outside of the packing so that it is safe for transport.
 5. Ship the pipette.

10 Disposal

10.1 Preparing for disposal

Preparing disposal in accordance with legal regulations



For information on the legal regulations that apply in your country, please contact your local competent authority or your Eppendorf partner.



Dispose of non-decontaminable devices as hazardous waste.

1. Check which legal regulations apply to disposal in your country.
2. Choose a certified disposal company or contact your Eppendorf partner.











Creating a decontamination certificate

Prerequisites:







- The device has been decontaminated.

1. Download a decontamination certificate from our webpage www.eppendorf.com.
2. Complete the decontamination certificate.

Technical dataEppendorf Research® plus
English (EN)**11 Technical data****11.1 Adjustable sub-steps****Single-channel pipettes**

Model	Color symbol	Color name	Increment
0.1 µL – 2.5 µL		dark gray	0.002 µL
0.5 µL – 10 µL		medium gray	0.01 µL
2 µL – 20 µL		light gray	0.02 µL
2 µL – 20 µL		yellow	0.02 µL
10 µL – 100 µL		yellow	0.1 µL
20 µL – 200 µL		yellow	0.2 µL
30 µL – 300 µL		orange	0.2 µL
100 µL – 1000 µL		blue	1 µL
0.25 mL – 2.5 mL		red	2 µL
0.5 mL – 5 mL		violet	0.005 mL
1 mL – 10 mL		turquoise	0.01 mL

Multi-channel pipettes

Model	Color symbol	Color name	Increment
0.5 µL – 10 µL		medium gray	0.01 µL
1 µL – 20 µL		light pink	0.02 µL
5 µL – 100 µL		light yellow	0.1 µL
10 µL – 100 µL		yellow	0.1 µL
30 µL – 300 µL		orange	0.2 µL
120 µL – 1200 µL		dark green	1 µL

11.2 Ambient conditions

Operation

Operating temperature	5 °C – 40 °C
Relative humidity	10 % – 95 %

Storage in transport packing

Air temperature	-25 °C – 55 °C
Relative humidity	10 % – 95 %

Storage without transport packing

Air temperature	-5 °C – 45 °C
Relative humidity	10 % – 95 %



Technical data

Eppendorf Research® plus
English (EN)











11.3 Errors of measurement

Single-channel pipettes with fixed volume setting

Model	Test tip epT.I.P.S.	Error of measurement			
		Systematic		Random	
		±%	±μL	%	μL
10 μL ■ medium gray	0.1 μL – 20 μL ■ medium gray 40 mm	1.2	0.12	0.6	0.06
20 μL ■ light gray	0.5 μL – 20 μL L ■ light gray 46 mm	0.8	0.16	0.3	0.06
10 μL ■ yellow	2 μL – 200 μL ■ yellow 53 mm	1.2	0.12	0.6	0.06
20 μL yellow		1.0	0.2	0.3	0.06
25 μL ■ yellow		1.0	0.25	0.3	0.08
50 μL ■ yellow		0.7	0.35	0.3	0.15
100 μL yellow		0.6	0.6	0.2	0.2
200 μL ■ yellow		0.6	1.2	0.2	0.4
200 μL ■ blue	50 μL – 1000 μL ■ blue 71 mm	0.6	1.2	0.2	0.4
250 μL ■ blue		0.6	1.5	0.2	0.5













Model	Test tip epT.I.P.S.	Error of measurement			
		Systematic		Random	
		±%	±μL	%	μL
500 μL  blue		0.6	3.0	0.2	1.0
1000 μL  blue		0.6	6.0	0.2	2.0

Single-channel pipettes with variable volume setting

Model	Test tip epT.I.P.S.	Testing volume	Error of measurement			
			Systematic		Random	
			±%	±μL	%	μL
0.1 μL – 2.5 μL  dark gray	0.1 μL – 10 μL  dark gray 34 mm	0.1 μL	48	0.048	12	0.012
		0.25 μL	12	0.03	6.0	0.015
		1.25 μL	2.5	0.031	1.5	0.019
		2.5 μL	1.4	0.035	0.7	0.018
0.5 μL – 10 μL  medium gray	0.1 μL – 20 μL  medium gray 40 mm	0.5 μL	8.0	0.04	5.0	0.025
		1 μL	2.5	0.025	1.8	0.018
		5 μL	1.5	0.075	0.8	0.04
		10 μL	1.0	0.1	0.4	0.04
2 μL – 20 μL  light gray	0.5 μL – 20 μL L  light gray 46 mm	2 μL	5.0	0.1	1.5	0.03
		10 μL	1.2	0.12	0.6	0.06
		20 μL	1.0	0.2	0.3	0.06
2 μL – 20 μL  yellow	2 μL – 200 μL  yellow 53 mm	2 μL	5.0	0.1	1.5	0.03
		10 μL	1.2	0.12	0.6	0.06
		20 μL	1.0	0.2	0.3	0.06
10 μL – 100 μL  yellow	2 μL – 200 μL  yellow	10 μL	3.0	0.3	1.0	0.1
		50 μL	1.0	0.5	0.3	0.15

Technical data









Eppendorf Research® plus
English (EN)

Model	Test tip epT.I.P.S.	Testing volume	Error of measurement			
			Systematic		Random	
			±%	±μL	%	μL
	53 mm	100 μL	0.8	0.8	0.2	0.2
20 μL – 200 μL  yellow	2 μL – 200 μL  yellow 53 mm	20 μL	2.5	0.5	0.7	0.14
		100 μL	1.0	1.0	0.3	0.3
		200 μL	0.6	1.2	0.2	0.4
30 μL – 300 μL  orange	20 μL – 300 μL  orange 55 mm	30 μL	2.5	0.75	0.7	0.21
		150 μL	1.0	1.5	0.3	0.45
		300 μL	0.6	1.8	0.2	0.6
100 μL – 1000 μL  blue	50 μL – 1000 μL  blue 71 mm	100 μL	3.0	3.0	0.6	0.6
		500 μL	1.0	5.0	0.2	1.0
		1000 μL	0.6	6.0	0.2	2.0
0.25 mL – 2.5 mL  red	0.25 mL – 2.5 mL  red 115 mm	0.25 mL	4.8	12	1.2	3
		1.25 mL	0.8	10	0.2	2.5
		2.5 mL	0.6	15	0.2	5
0.5 mL – 5 mL  violet	0.1 mL – 5 mL  violet 120 mm	0.5 mL	2.4	12	0.6	3
		2.5 mL	1.2	30	0.25	6.25
		5.0 mL	0.6	30	0.15	7.5
1 mL – 10 mL  turquoise	0.5 mL – 10 mL  turquoise 165 mm	1.0 mL	3.0	30	0.6	6
		5.0 mL	0.8	40	0.2	10
		10.0 mL	0.6	60	0.15	15

Multi-channel pipettes with fixed cone spacing

Model	Test tip epT.I.P.S. epT.I.P.S. 384	Testing volume	Error of measurement			
			Systematic		Random	
			±%	±µL	%	µL
0.5 µL – 10 µL ■ medium gray 8-/12-channel	0.1 µL – 20 µL ■ medium gray 40 mm	0.5 µL	12	0.06	8.0	0.04
		1 µL	8.0	0.08	5.0	0.05
		5 µL	4.0	0.2	2.0	0.1
		10 µL	2.0	0.2	1.0	0.1
1 µL – 20 µL ■ light pink 16-/24-channel	1 µL – 20 µL ■ light pink 42 mm	1 µL	12	0.12	8	0.08
		2 µL	8	0.16	5	0.1
		10 µL	4	0.4	2	0.2
		20 µL	2	0.4	1	0.2
5 µL – 100 µL ■ light yellow 16-/24-channel	5 µL – 100 µL ■ light yellow 53 mm	5 µL	6	0.3	4	0.2
		10 µL	3	0.3	2	0.2
		50 µL	1.2	0.6	0.8	0.4
		100 µL	1	1	0.6	0.6
10 µL – 100 µL ■ yellow 8-/12-channel	2 µL – 200 µL ■ yellow 53 mm	10 µL	3.0	0.3	2.0	0.2
		50 µL	1.0	0.5	0.8	0.4
		100 µL	0.8	0.8	0.3	0.3
30 µL – 300 µL ■ orange 8-/12-channel	20 µL – 300 µL ■ orange 55 mm	30 µL	3.0	0.9	1.0	0.3
		150 µL	1.0	1.5	0.5	0.75
		300 µL	0.6	1.8	0.3	0.9
120 µL – 1200 µL ■ dark green 8-/12-channel	50 µL – 1200 µL L ■ dark green 103 mm	120 µL	6.0	7.2	0.9	1.08
		600 µL	2.7	16.2	0.4	2.4
		1200 µL	1.2	14.4	0.3	3.6

Multi-channel pipettes with variable volume setting

Model	Test tip epT.I.P.S. epT.I.P.S. 384	Testing volume	Error of measurement			
			Systematic		Random	
			±%	±µL	%	µL
1 µL – 20 µL  light pink 8-/12-channel	1 µL – 20 µL  light pink 42 mm	1 µL	15	0.15	8	0.08
		2 µL	10	0.2	5	0.1
		10 µL	4	0.4	2	0.2
		20 µL	2	0.4	1	0.2
5 µL – 100 µL  light yellow 8-/12-channel	5 µL – 100 µL  light yellow 53 mm	5 µL	6	0.3	4	0.2
		10 µL	3	0.3	2	0.2
		50 µL	1.2	0.6	0.8	0.4
		100 µL	1	1	0.6	0.6
30 µL – 300 µL  orange 4-/6-/8-channel	20 µL – 300 µL  orange 55 mm	15 µL	7.4	1.1	2	0.3
		30 µL	3.7	1.1	1.8	0.5
		150 µL	1	1.5	0.6	0.9
		300 µL	0.7	2.1	0.6	1.8
120 µL – 1200 µL  dark green 4-/6-/8-channel	50 µL – 1250 µL L  dark green 103 mm	50 µL	14.5	7.25	2	1
		120 µL	6	7.2	1.3	1.6
		600 µL	2.7	16.2	0.4	2.4
		1200 µL	1.2	14.4	0.3	3.6

11.4 Test conditions

Test conditions and test evaluation in accordance with DIN EN ISO 8655. Tested using a certified analytical balance with evaporation protection.

- Number of determinations per volume: 10
- Water according to ISO 3696
- Testing at 20 °C (±3 °C) – 27 °C (±3 °C)
Maximum temperature fluctuation during measurement ±0.5 °C
- Dispensing onto the tube inner wall

11.5 Materials

Component	Material
Outer surfaces of the upper part	<ul style="list-style-type: none"> • Improved Polypropylene (PP) • Polycarbonate (PC) • Polyetherimide (PEI) • Foil
Viewing window	<ul style="list-style-type: none"> • Polycarbonate (PC)
Lower parts outside and inside	<ul style="list-style-type: none"> • Improved Polypropylene (PP) • Polyvinylidene fluoride (PVDF) • Polyetherimide (PEI) • Polyphenylene sulfide (PPS) • Polyetheretherketone (PEEK) • Polytetrafluorethylene (PTFE) • Ethylene propylene diene rubber (EPDM) • Silicone • Steel (stainless steel and spring steel)

Ordering informationEppendorf Research® plus
English (EN)**12 Ordering information****12.1 Single-channel pipettes with fixed volume setting**

Description	Order no.
Eppendorf Research® plus	
1-channel, fixed	
10 µL, medium gray	3124 000 016
10 µL, yellow	3124 000 024
20 µL, light gray	3124 000 032
20 µL, yellow	3124 000 040
25 µL, yellow	3124 000 059
50 µL, yellow	3124 000 067
100 µL, yellow	3124 000 075
200 µL, yellow	3124 000 083
200 µL, blue	3124 000 091
250 µL, blue	3124 000 105
500 µL, blue	3124 000 113
1,000 µL, blue	3124 000 121

12.2 Single-channel pipettes with variable volume setting

Description	Order no.
Eppendorf Research® plus	
1-channel, variable, incl. epT.I.P.S.® Box 2.0 with 96 pipette tips	
0.1 – 2.5 µL, dark gray, ACT	3123 000 012
0.5 – 10 µL, medium gray	3123 000 020
2 – 20 µL, yellow, ACT	3123 000 039
10 – 100 µL, yellow, ACT	3123 000 047
20 – 200 µL, yellow, ACT	3123 000 055
100 – 1,000 µL, blue, ACT	3123 000 063
2 – 20 µL, light gray, ACT	3123 000 098

Description	Order no.
30 – 300 µL, orange, ACT 1-channel, variable, incl. epT.I.P.S.® 5 mL sample bag with 10 pipette tips	3123 000 101
0.5 – 5 mL, violet, ACT 1-channel, variable, incl. epT.I.P.S.® 10 mL sample bag with 10 pipette tips	3123 000 071
1 – 10 mL, turquoise, ACT 1-channel, variable, incl. epT.I.P.S.® 2.5 mL sample bag with 10 pipette tips	3123 000 080
0.25 – 2.5 mL, red, ACT	3123 000 144

12.3 Multi-channel pipettes with fixed cone spacing

9 mm cone spacing for 96-well plates

Description	Order no.
Eppendorf Research® plus 8-channel, variable, incl. epT.I.P.S.® Box 2.0 with 96 pipette tips	
0.5 – 10 µL, medium gray	3125 000 010
10 – 100 µL, yellow	3125 000 036
30 – 300 µL, orange	3125 000 052
12-channel, variable, incl. epT.I.P.S.® Box 2.0 with 96 pipette tips	
0.5 – 10 µL, medium gray	3125 000 028
10 – 100 µL, yellow	3125 000 044
30 – 300 µL, orange	3125 000 060
8-channel, variable	
120 – 1,200 µL, dark green	3125 000 214
12-channel, variable	
120 – 1,200 µL, dark green	3125 000 222

Ordering informationEppendorf Research® plus
English (EN)**4.5 mm cone spacing for 384-well plates**

Description	Order no.
Eppendorf Research® plus	
16-channel, variable, incl. epT.I.P.S.® Box 2.0 with 384 pipette tips 1 – 20 µL, light pink	3125 000 079
5 – 100 µL, light yellow	3125 000 095
24-channel, variable, incl. epT.I.P.S.® Box 2.0 with 384 pipette tips 1 – 20 µL, light pink	3125 000 087
5 – 100 µL, light yellow	3125 000 109

12.4 Pipette tips, accessories and spare parts

Ordering information for pipette tips, accessories and spare parts can be found on the webpage www.eppendorf.com.



Evaluate Your Manual

Give us your feedback.

www.eppendorf.com/manualfeedback

Your local distributor: www.eppendorf.com/contact
Eppendorf SE · Barkhausenweg 1 · 22339 Hamburg · Germany
eppendorf@eppendorf.com · www.eppendorf.com