

General Lab Products



Reliable Performance

Centrifuge 5804/5804 R and Centrifuge 5810/5810 R



Introducing the Eppendorf 58xx Centrifuge Family

Reliable performance

The Eppendorf approach to product development is, and always has been, about giving you more. More quality, more innovation. All of our centrifuges personalize this philosophy.

They all go beyond speed and capacity to offer you unparalleled ergonomic operation, excellent temperature control, and outstanding product quality. Each centrifuge is

designed to operate at low noise levels for a relaxing work environment and offers soft-touch lid closure for ease of use and a low profile for easy loading and unloading of samples.

Refrigerated centrifuge models have exclusive features such as ECO shut-off and dynamic compressor control for maximum sample protection and energy savings.

The Benchmark in Ergonomic Operation

Low profile for easy operation

The 58xx centrifuges are designed with a particularly low height in mind. Not only does the low profile facilitate easy loading and unloading, it also allows everyone in the lab to easily reach the open centrifuge lid.



Soft-touch lid closure

There's no need to exert unnecessary high force when closing the centrifuge lid. The soft-touch lid closure allows closing the centrifuge with ease.



Eppendorf QuickLock® caps for one-hand operation

Aerosol-tight caps provide the needed safety when working with potentially hazardous samples. The caps for the 4 × 750 mL swing-bucket rotor allow for easy, one-handed operation. Its unique design allows the closed bucket to be carried securely to the biosafety cabinet.



Eppendorf QuickLock® rotor lids for ergonomic lid locking

Our aerosol-tight QuickLock rotors close with only ¼ of a turn. This not only saves you time during every day use, it also takes repetitive stress off your wrist.



Centrifuge 5804/5804 R



Centrifuge 5804 with plate rotor A-2-DWP



Centrifuge 5804 R with rotor S-4-72 (4 × 250 mL)

The Centrifuge 5804/5804 R is a high speed centrifuge for medium capacity needs. It allows for applications in tubes up to 250 mL and offers additional swing-bucket and fixed-angle rotors as well as deepwell plate capacity for increased versatility. Common rotors for Centrifuge 5804/5804 R include:



S-4-72
4 × 250 mL swing-bucket rotor.
Max. speed 3,234 × g (4,200 rpm).



A-2-DWP
2-place deepwell plate rotor
for plates up to 89 mm
loading height. Max. speed
2,250 × g (3,750 rpm).



FA-45-6-30
6 × 50 mL conical tube rotor with
aerosol-tight QuickLock lid for
tubes from 5–50 mL. Max. speed
16,639 × g (11,000 rpm).



FA-45-30-11
30 × 1.5/2 mL micro tube rotor
with aerosol-tight lid for safe
centrifugation of hazardous
samples. Max. speed 20,800 × g
(14,000 rpm).

Eppendorf recognizes its responsibility as a global citizen. Protecting the environment is critical to the conservation of precious natural resources. The Eppendorf epGreen® initiative is another example of our commitment to social responsibility. Our goal is to constantly reduce the environmental impact of our business operations and the products that we produce.

Centrifuges in general

- > Use of brushless induction motors to provide maintenance-free operation, eliminating carbon particle emissions
- > Rotors are mostly made of recyclable aluminum
- > Optimized sound design for low noise levels to benefit your work environment
- > 100 % recyclable packaging material

Centrifuge 5810/5810 R



Centrifuge 5810 with rotor S-4-104 (4 × 750 mL)



Centrifuge 5810 R with rotor S-4-104 (4 × 750 mL)

The Centrifuge 5810/5810 R is a workhorse for medium to high-throughput laboratories. It combines extraordinary versatility and capacity for both tubes and plates with an extraordinary compact footprint. Common rotors for Centrifuge 5810/5810 R include:

S-4-104



4 × 750 mL swing-bucket rotor with optional aerosol-tight QuickLock caps. Max. speed 3,214 × *g* (3,900 rpm).

Rotor S-4-104 is also available with plate buckets and optional aerosol-tight QuickLock caps.

FA-45-6-30



6 × 50 mL conical tube rotor with aerosol-tight QuickLock lid for tubes from 5–50 mL. Max. speed 20,130 × *g* (12,000 rpm).

FA-45-48-11



48 × 1.5/2 mL micro tube rotor with aerosol-tight QuickLock rotor lid for safe centrifugation of hazardous samples. Max. speed 19,083 × *g* (13,000 rpm).

Refrigerated models additionally feature

- > Dynamic compressor control for precise cooling performance
- > CFC-free refrigerant with an ozone depletion potential (ODP) of zero
- > ECO shut-off deactivates the compressor after 8 hours of inactivity to reduce energy consumption and extend compressor life

Energy saving through 2nd generation of swing-bucket rotors*

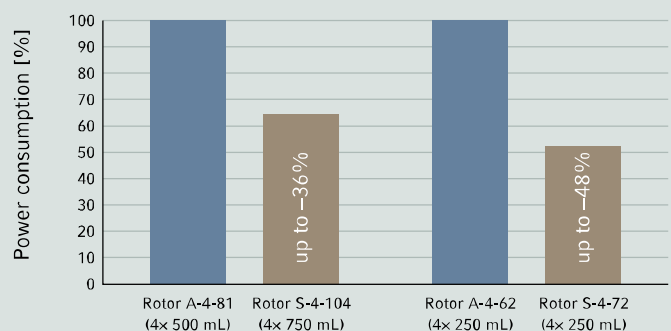

* based on internal testing with Centrifuge 5810 R, 230 V

Performance You Can Count On



> Watch video clips of Centrifuge 5810 R on our optimized webpage for mobile devices or www.eppendorf.com/centrifugation

Ergonomic lid operation

- > Soft-touch lid closure and low opening height for stress-free lid locking

Precise cooling performance

- > Dynamic compressor control with ECO shut-off function

Mixed loading capability

- > Rotors S-4-104 and A-4-81 provide mixed loading capability with plate and tube buckets for increased versatility

Quiet operation

- > All models are designed to operate at low noise levels for a relaxing work environment

Low access height (29 cm)

- > Easy loading/unloading of samples

Placement flexibility

- > Compact footprint
- > Low opening height for use under shelves
- > Rolling cabinet option available for use in crowded labs

Outstanding versatility for all your applications

- > Broad rotor and adapter selection to spin all commonly used tubes, bottles, flasks, and plates
- > High centrifugation speed up to $20,913 \times g$ (14,000 rpm) for applications in tubes from 0.2 to 750 mL
- > Aerosol-tight rotors (e.g. for potentially hazardous materials)

The benchmark for ergonomic operation

- > Low sound level to benefit your work environment
- > Low access height (29 cm) for easy loading/unloading
- > Centrifuge lid with soft-touch lid closure

Designed to fit in every lab

- > Compact footprint saves valuable bench space
- > Low lid opening height for use under shelves
- > Automatic rotor recognition and imbalance detection for maximum operational safety

Advanced temperature management for maximum sample protection and energy efficiency

- > Temperature range from $-9\text{ }^{\circ}\text{C}$ to $40\text{ }^{\circ}\text{C}$
- > Maintains constant $4\text{ }^{\circ}\text{C}$, even at maximum speed (rotors F-34-6-38 and FA-45-6-30 maintain $4\text{ }^{\circ}\text{C}$ at 11,000 rpm)
- > FastTemp function for quick pre-cooling
- > Continuous cooling maintains a constant temperature after the run has been completed - your samples stay cool
- > ECO shut-off engages after 8 hours of non-use to reduce energy consumption and extend compressor life
- > Dynamic compressor control (DCC) technology for precise cooling performance

Rotor Design at Its Best

Eppendorf's 2nd generation of swing-bucket and fixed-angle rotors elevate your centrifuge performance to a new level.

Enjoy unique product features that improve handling and performance.

Swing-bucket rotors

Improved energy efficiency

The round buckets have been designed to be especially aerodynamic. The result is a more efficient design that reduces power consumption by up to 48 %.

Longer rotor lifetime

The 2nd rotor generation of both swing-bucket and fixed-angle rotors has been designed with a particularly long lifetime in mind.

Eppendorf QuickLock® caps for one-hand operation

- > Significantly improved handling, easy operation with one hand
- > Handle allows the closed bucket to be carried to the biosafety cabinet where it can be opened in a safe environment
- > Aerosol-tightness has been tested and verified by Public Health England, Porton Down, UK



Fixed-angle rotors

Low rotor weight

Eppendorf's fixed-angle rotors are among the lightest in the industry to improve handling and operational safety. Light-weight rotors cause less wear and tear on the motor and allow for faster acceleration and braking times.

Eppendorf QuickLock® lids for ergonomic lid locking

Our aerosol-tight QuickLock rotors close with only $\frac{1}{4}$ of a turn. This not only saves you time during every day use, it also takes repetitive stress off your wrist.

Superior temperature control

Aluminum, with its high heat conductivity, allows fast pre-cooling and accurate temperature control in refrigerated centrifuges.

Additional rotor features

- > All rotors are anodized for high chemical resistance and to prevent corrosion
- > Optimized design of rotor boreholes and adapters provide optimal support for high-speed centrifugation of tubes
- > Aluminum rotors are recyclable







Cross section of Rotor FA-45-6-30

(6 × 50 mL conical) showing the light-weight design.

All metal not needed for safety or performance is hollowed out to reduce weight and improve handling.

Exceptional Versatility

Overview of the main rotors

Rotor image					
					
Rotor name	S-4-104 (4 x 750 mL) aerosol-tight QuickLock caps	A-4-81 (4 x 500 mL) aerosol-tight	A-4-62 (4 x 250 mL) aerosol-tight	S-4-72 (4 x 250 mL)	A-4-44 (4 x 100 mL) aerosol-tight
5804/ 5804 R				x	x
5810/ 5810 R	x	x	x	x	x
Positioning	High-capacity swing- bucket rotor	Medium to high capacity swing- bucket rotor	Economic swing- bucket rotor for medium capacity	Economic swing- bucket rotor for medium capacity	High-speed swing- bucket rotor
Aerosol-tightness	yes	yes	yes	no	yes
Max. speed (RCF)	3,214	3,220	3,220	3,234	4,500
Max. speed (rpm)	3,900	4,000	4,000	4,200	5,000
Volume range	0.2–750 mL MTP/DWP	0.2–500 mL, MTP/DWP	0.2–250 mL, MTP/DWP	0.2–250 mL	0.2–100 mL
Eppendorf Tubes® 5.0 mL and 15 mL conical	56	48	36	32	16
50 mL conical	28	20/28* ¹	16	16	4/8* ¹
13 mm blood tube	92	100	60	56	36
16 mm blood tube	80	64	48	52	28
1.5/2.0 mL micro tube	200	96	64	104	48
MTP	16	16	12		
DWP	4	4	4		

*¹ Maximum capacity with dedicated 50 mL bucket.



epServices
for premium performance

Centrifuge Performance Plans

An annual inspection and maintenance of centrifuges and rotors by an Eppendorf certified service technician is highly recommended to ensure a safe working environment.

■ ESSENTIAL CHECK

> Check of all fundamental functions of the product

■ PREMIUM SERVICE

> Complete maintenance and repair service agreement solution for your peace of mind

■ ADVANCED MAINTENANCE

> Preventive maintenance service to meet manufacturer specifications



A-2-DWP-AT (2 x 6 MTP) aerosol-tight	A-2-DWP (2 x 5 MTP)	F-34-6-38 (6 x 85 mL)	FA-45-6-30 (6 x 50 mL) aerosol-tight QuickLock lid	FA-45-48-11 (48 x 2 mL) aerosol-tight QuickLock lid
	x	x	x	x
x	x	x	x	x
Aerosol-tight deepwell plate rotor for safe centrifugation of hazardous samples.	Economic deepwell plate rotor	High-speed rotor suitable for molecular biology applications in tubes up to 85 mL	Aerosol-tight high-speed rotor for safe centrifugation of hazardous samples	Aerosol-tight microcentrifuge tube rotor for safe centrifugation of hazardous samples
yes	no	no	yes	yes
3,486	2,250	18,500/15,500*2	20,130/16,639*2	19,083
4,500	3,700	12,000/11,000*2	12,100/11,000*2	13,000
MTP/DWP	MTP/DWP	0.2–85 mL	5–50 mL	0.2–2.0 mL
		6	6	
		6	6	
		18	6	
		12	6	
48	48	24		48
12	10			
4	4			

*2 Max. speed in Centrifuge 5810 R, lower speed applies to Centrifuge 5804/5804R/5810.

Certification Services

Our Installation Qualification (IQ) and Operational Qualification (OQ) services make sure that temperature accuracy, rotational speed verification and operating time meet manufacturer's specifications.

Over the years, all rotor structures will eventually suffer from fatigue due to stress of high numbers of cycles. If not maintained correctly, surface scratches can lead to microscopic and then to critical cracks. Qualified inspection will detect damages early in order to prevent further equipment failure. Our service includes cleaning, instructions for proper care, and visual examination of rotors and adapters

determining if the rotor is safe for further operation or needs to be replaced.

The Performance Plans feature

- > Manufacturer-specific test procedures
- > GLP supporting documentation

Value of service

- > Highest degree of security in your lab
- > Longer service life of the system







> Further information and local offers in your country: www.eppendorf.com/epServices

Rotor S-4-104

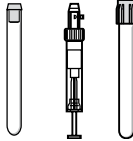
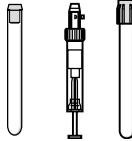
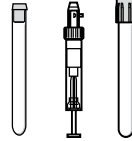

Product features

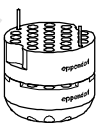
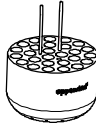
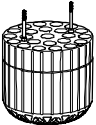
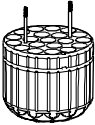
- > High capacity swing-bucket rotor with max. speed $3,214 \times g$ (3,900 rpm)
- > Rotor S-4-104 accommodates tubes and bottles from 0.2 mL to 750 mL as well as plates
- > Aerodynamic round bucket design for up to 36 % energy savings compared to Rotor A-4-81
- > Mixed loading with 2 plate buckets and 2 round tube buckets allows for increased versatility
- > Aerosol-tight Eppendorf QuickLock caps for safe centrifugation of hazardous samples optionally available*1
- > Rotor life time: max. 100,000 cycles
- > Buckets, caps, and adapters are autoclavable

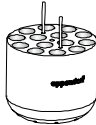
Tube						
Tube capacity (mL)	1.5/2.0	12 x 75 mm, 5 mL FACS	2.6-8	5.5-12	9	14
Max. tube diameter (Ø mm)	11	12	13	16	17.5	17.5
Max. vessel height (mm)	39	111	115	119	111	117
Max. vessel height for use with aerosol-tight lid (mm)*2	39	100	108	114	106	112
Adapter/bucket options for Rotor S-4-104						
Capacity per bucket/rotor	50/200	27/108	23/92	20/80	20/80	14/56
Adapter bottom shape	flat	round	round	round	round	round
Centrifugation radius (mm)	188	175	179	180	179	185
Max. RCF (g-force)	3,197	2,976	3,044	3,061	3,044	3,146
Order no. (set of 2)	5825 740.009	5825 747.003	5825 738.004	5825 736.001	5825 743.008	5825 748.000

*1 Aerosol-tightness tested by Public Health England, Porton Down, UK.

*2 Exceeding the maximum tube length may reduce the loading capacity of the rotor. Please perform a manual swing-out test before starting the centrifuge run to make sure the tubes do not hit the rotor yoke.

*3 Please note that these conical bottles need to be used together with a conical form insert provided by the manufacturer.











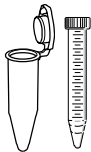

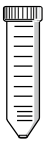

*4 Available as a set of 2 bottles (see ordering information).

*5 Please note that a software upgrade may be necessary for older centrifuges when using Rotor S-4-104.

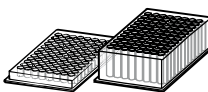
Please contact your local Eppendorf organization or dealer for further information

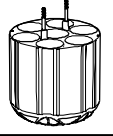
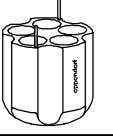
Ordering information

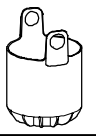
Description	Order no.
Rotor S-4-104*5	
Rotor S-4-104, incl. 4 × 750 mL round buckets	5820 740.000
Rotor S-4-104, incl. 4 × Plate bucket (aerosol-tight capable)	5820 754.001
Rotor S-4-104, without buckets	5820 755.008
Buckets for Rotor S-4-104*5	
Plate bucket (aerosol-tight capable), incl. plate carrier, set of 4	5820 743.000
Plate bucket (aerosol-tight capable), incl. plate carrier, set of 2	5820 744.006
Accessories	
Aerosol-tight caps*1, for 750 mL round buckets, set of 2	5820 747.005
Aerosol-tight caps*1, for Plate bucket (aerosol-tight capable), set of 2	5820 748.001
750 mL wide-mouth bottle, set of 2	5820 708.000

								
Eppendorf Tubes® 5.0 mL and 15 mL conical	30 mL	50 mL conical	50 mL conical skirted	175– 225 mL conical, Nunc® 250 mL conical	250 mL flat	500 mL Corning®	750 mL Eppendorf bottle*4 (order no. 5820 708.000)	MTP, DWP, PCR plates
17	25	31	31	*3	62	98	104	–
125	111	122	120		145	136	150	60
120	106	116	116		125	–	–	45
								
14/56	8/32	7/28	5/20	1/4	1/4	1/4	4/16 (MTP) 1/4 (DWP)	
conical	flat	conical	conical, skirted	flat	conical	flat	flat	
188	174	187	178	183	187	185	151	
3,197	2,958	3,180	3,027	3,112	3,171	3,146	2,568	
5825 734.009	5825 755.006	5825 733.002	5825 732.006	5825 741.005	5825 745.000	5825 744.004	5820 744.006	







Rotor A-4-81

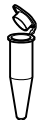

Product features

- > Swing-bucket rotor with max. speed $3,220 \times g$ (4,000 rpm)
- > Rotor A-4-81 accommodates tubes and flasks from 0.2 mL to 500 mL as well as plates
- > Aerosol-tight caps*¹ for safe centrifugation of hazardous samples optionally available
- > Mixed loading with 2 plate buckets and 2 rectangular tube buckets allows for increased versatility
- > Rotor life time: max. 100,000 cycles
- > Buckets, caps, and adapters are autoclavable

Tube

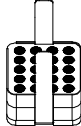
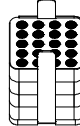
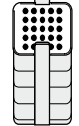
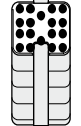
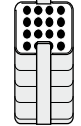
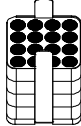
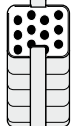
							
Tube capacity (mL)	1.5/2	1.2–5	1.8–7	2.6–7	4–10	7–17	Eppendorf Tubes® 5.0 mL and 15 mL conical
Max. tube diameter (Ø mm)	11	11	13	13	16	17.5	17
Max. vessel height (mm)^{*2}	118	118	118	118	118 (130 mm in 2 inner rows) ^{*2}	118 (130 mm in 2 inner rows) ^{*2}	122
Max. vessel height for use with aerosol-tight lid^{*1} (mm)	108	108	108	108	108 (130 mm in 4 center pos.) ^{*2}	108 (130 mm in 4 center pos.) ^{*2}	120
Adapter/bucket options for Rotor A-4-81							
Capacity per bucket/rotor	20/80	20/80	25/100	18/72	16/64	16/64	12/48
Adapter bottom shape	flat	flat with rubber mat	flat with rubber mat	flat with rubber mat	flat with rubber mat	flat with rubber mat	conical
Centrifugation radius (cm)	16.5	16.8	16.8	16.8	16.8	16.8	17.3
Max. RCF (g-force)	2,950	3,000	3,000	3,000	3,000	3,000	3,100
Order no. (set of 2)	5810 745.004	5810 746.000	5810 720.001	5810 747.007	5810 748.003	5810 721.008	5810 722.004

^{*1} Aerosol-tightness tested by Public Health England, Porton Down, UK.













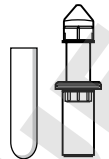

^{*2} Exceeding the maximum tube length may reduce the loading capacity of the rotor.

Please perform a manual swing-out test before starting the centrifuge run to make sure the tubes do not hit the rotor yoke.

^{*3} Only Centriprep® tube without locking lid.

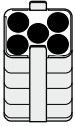
Ordering information

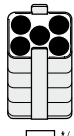
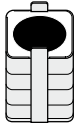
Description	Order no.
Rotor A-4-81	
Rotor A-4-81, incl. 4 × 500 mL rectangular buckets	5810 718.007
Rotor A-4-81, incl. 4 × MTP/Flex plate buckets	5810 725.003
Rotor A-4-81 without buckets	5810 743.001
Buckets for Rotor A-4-81	
Bucket, 500 mL rectangular, set of 4	5810 730.007
Bucket, 7 × 50 mL conical, set of 4	5825 730.003
Bucket, MTP/Flex plates, set of 2	5810 742.005
Bucket, MTP/Flex plates, set of 4	5810 741.009
Accessories	
Aerosol-tight cap ² for 500 mL rectangular bucket, set of 2	5810 724.007
Bottle 400 mL wide-mouth, includes stabilizing sleeves, set of 2	5810 729.009
Bottle 500 mL wide-mouth, set of 2	5820 707.003

									
50 mL conical	50 mL conical, skirted	30–50 mL and 50 mL Centriprep [®]	175–225 conical	180–250	400 mL bottle* ⁵ (5810 729.009)	500 mL bottle* ⁵ (5820 707.003)	MTP and PCR plates	Cell culture plates	DWP
31	31	29	61	81	83	–	–	–	
122	122	122	133	135	135	60	60	60	
116	–	116	–	–	135	–	–	–	
					no adapter needed	See page 23 for additional adapters			
5/20 conical	7/28 conical	5804 737.008 5/20 flat with rubber mat	1/4 flat with rubber mat	1/4 flat, rubber	–	4/16	2/8	1/4	
17.3	18.0	17.3	17.3	18.0	18.0	flat with rubber mat			
3,100	3,250	3,100	3,100	3,220	3,220	2,900			
5810 723.000	5825 730.003 ⁷	5810 739.004	5825 722.000	5810 728.002	–	5810 742.005	5810 741.009* ⁶		

⁴ Please note that these conical flasks need to be used together with a conical form insert provided by the flask manufacturer.

⁵ Available as a set of 2 flasks (see ordering information).

⁶ Set of 4.







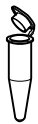
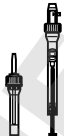
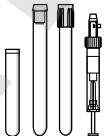
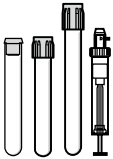
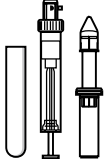

⁷ 50 mL conical tubes skirted need to be ordered separately. Order no. 5804 737.008 (set of 8).

Rotor A-4-62

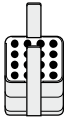
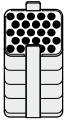
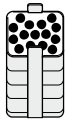

Product features

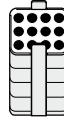
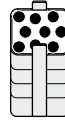
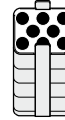
- > Economic swing-bucket rotor with speed up to $3,220 \times g$ (4,000 rpm)
- > Rotor A-4-62 accommodates tubes and flasks from 0.2 mL to 250 mL as well as plates
- > Aerosol-tight caps*¹ for safe centrifugation of hazardous samples optionally available
- > Rotor life time: max. 40,000 cycles
- > Rotor, buckets, caps, and adapters are autoclavable

Tube								
Tube capacity (mL)	1.5/2	1.2-5	1.8-7	4-10	7-17	Eppendorf Tube® 5.0 mL and 15 mL conical	7-18	18-30
Max. tube diameter (Ø mm)	11	11	13	16	17.5	17	20	26
Max. vessel height (mm)* ²	122	123	121	121 (130 mm in 2 center rows)* ²	118 (130 mm in 2 center rows)* ²	127	126	119
Max. vessel height for use with aerosol-tight lid* ¹ (mm)	118	115	118	116 (130 mm in 2 inner pos.)	114 (130 mm in 2 inner pos.)	121	119	116
Adapter/bucket options for Rotor A-4-62								
Capacity per bucket/rotor	16/64	25/100	15/60	12/48	12/48	9/36	8/32	4/16
Adapter bottom shape	flat	flat with rubber mat	flat with rubber mat	flat with rubber mat	flat with rubber mat	conical	flat with rubber mat	flat with rubber mat
Centrifugation radius (cm)	17.1	17.3	17.3	17.3	17.3	17.8	17.3	17.3
Max. RCF (g-force)	3,000	3,050	3,050	3,050	3,050	3,150	3,050	3,050
Order no. (set of 2)	5810 751.004	5810 750.008	5810 752.000	5810 753.007	5810 754.003	5810 755.000	5810 756.006	5810 757.002











*¹ Aerosol-tightness tested by the Centre for Public Health England, Porton Down, UK.

*² Exceeding the maximum tube length may reduce the loading capacity of the rotor. Please perform a manual swing-out test before starting the centrifuge run to make sure the tubes do not hit the rotor yoke.

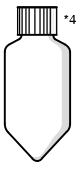
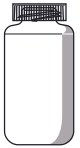
*³ For high g-forces we recommend using centrifuge tubes of Duran® glass.

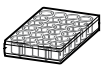
Ordering information

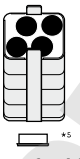
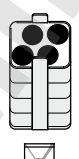
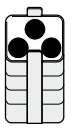
Description	Order no.
Rotor A-4-62	
Rotor A-4-62, incl. 4 × 250 mL rectangular buckets	5810 709.008
Rotor A-4-62, incl. 4 × MTP plate buckets	5810 711.002
Buckets for Rotor A-4-62	
Bucket, 250 mL rectangular, set of 4	5810 716.004
Bucket, MTP plates, set of 4	5810 702.003
Accessories	
Aerosol-tight cap*1 for 250 mL rectangular bucket, set of 2	5810 710.006

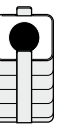
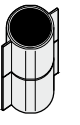
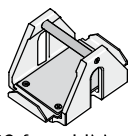
									
30–50	50 mL conical, skirted	50 mL conical	50–75	80–120	175–225 conical	180–250	MTP and PCR plates	Cell culture plates	DWP
29	31	31	35	45	62	–	–	–	–
122	122	122	122	139	137	53	53	53	–
116	–	–	116	118	125	127	–	–	–
									
5804 737.008						See page 23 for additional adapters			
4/16	4/16	3/12	2/8	1/4	1/4	4/16	2/8	1/4	
flat with rubber mat	flat w/conical form insert	conical	flat with rubber mat	flat with rubber mat	flat with rubber mat	flat with rubber mat			
17.3	17.3	17.8	17.3	17.3	18.0	15.4			
3,050	3,050	3,150	3,050	3,050	3,200	2,750			
5810 759.005	5810 763.002	5810 758.009	5810 760.003	5810 761.000	5810 770.009	5810 702.003*6			

*4 Please note that these conical flasks need to be used together with a conical form insert provided by the manufacturer.

*5 Form inserts for 50 mL conical tubes skirted need to be ordered separately. Order no. 5804 737.008 (set of 8).





*6 Set of 4.

Rotor S-4-72

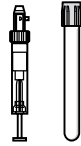
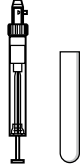
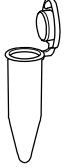
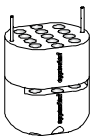
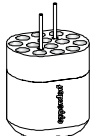

Product features

- > Medium capacity swing-bucket rotor with speed up to $3,234 \times g$ (4,200 rpm)
- > Broad range of adapters available to handle all common tube formats from 0.2 mL to 250 mL
- > Aerodynamic round bucket design for up to 48 % energy savings compared to Rotor A-4-62
- > Rotor life time: max. 60,000 cycles
- > Buckets and adapters are autoclavable

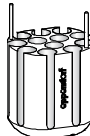
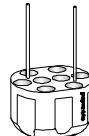
Tube					
Tube capacity (mL)	1.5/2.0	2.6–8 mL	5.5–12	9	Eppendorf Tubes® 5.0 mL
Max. tube diameter (Ø mm)	11	13	16	17.5	17
Max. vessel height (mm)*1	43	115	112	113	60
Max. vessel height for use with aerosol-tight lid*1 (mm)	–	–	–	–	–
Adapter options for Rotor S-4-72					
Capacity per bucket/rotor	26/104	14/56	13/52	12/48	8/32
Adapter bottom shape	flat	round	round	round	conical
Centrifugation radius (mm)	159	159	157	158	163
Max. RCF (g-force)	3,136	3,136	3,096	3,116	3,215
Order no. (set of 2)	5804 794.001	5804 789.008	5804 791.002	5804 792.009	5804 793.005

*1 Exceeding the maximum tube length may reduce the loading capacity of the rotor.





*2 Please note that these conical flasks need to be used together with a conical form insert provided by the flask manufacturer.

*3 Please note that a software upgrade may be necessary for older centrifuges when using Rotor S-4-72.

Please contact your local Eppendorf organization or dealer for further information

Ordering information

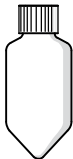
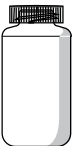
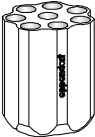
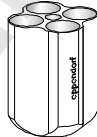
Description	Order no.
Rotor S-4-72* ³ , incl. 4 x 250 mL round buckets	5804 746.007









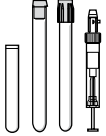
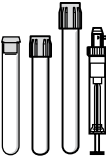
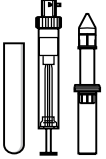

				
15 mL conical	50 mL conical	50 mL conical skirted	175-225 conical* ²	250 mL flat
17	31	31		62
120	120	120		130
-	-	-		-
				
8/32 conical	4/16 conical	2/8 flat		1/4 flat
164	164	153		161
3,234	3,234	3,017		3,175
5804 783.000	5804 784.006	5804 785.002		5804 787.005

Rotor A-4-44



Product features

- > High-speed swing-bucket rotor for applications up to $4,500 \times g$ (5,000 rpm)
- > Rotor A-4-44 accommodates tubes from 0.2 mL to 100 mL
- > Aerosol-tight caps*¹ for safe centrifugation of hazardous samples optionally available
- > Rotor life time: max. 34,000 cycles
- > Rotor, buckets, caps, and adapters are autoclavable

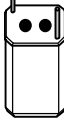
Tube							
Tube capacity (mL)	1.5/2	1.2-5	1.8-7	4-10	7-17	Eppendorf Tubes® 5.0 mL and 15 mL conical	
Max. tube diameter (Ø mm)	11	11	13	16	17.5	17	
Max. vessel height (mm)*²	111	105	108	108	110	121	
Max. vessel height for use with aerosol-tight lid*¹ (mm)	105	102	106	106	106	-	121
Adapter/bucket options for Rotor A-4-44							
Capacity per bucket/rotor	12/48	14/56	9/36	7/28	6/24	4/16	2/8
Adapter bottom shape	flat	flat with rubber mat	flat with rubber mat	flat with rubber mat	flat with rubber mat	conical	conical
Centrifugation radius (cm)	14.8	15.0	15.0	15.0	15.0	15.5	15.7
Max. RCF (g-force)	4,100	4,200	4,200	4,200	4,200	4,300	4,400
Order no. (set of 2)	5804 751.000	5804 750.004	5804 752.007	5804 753.003	5804 754.000	5804 755.006	5804 717.007

*¹Aerosol-tightness tested by Public Health England, Porton Down, UK.

*²Exceeding the maximum tube length may reduce the loading capacity of the rotor. Please perform a manual swing-out test before starting the centrifuge run to make sure the tubes do not hit the rotor yoke.

*³For high g-forces we recommend using centrifuge tubes of Duran® glass.

*⁴Reordering of 50 mL form inserts: 5804 728.009.















*⁵Max. load per bucket: 140 grams.

*⁶Set of 4.

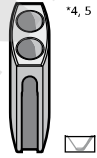
*⁷Form inserts for 50 mL conical tubes skirted need to be ordered separately. Order no. 5804 737.008 (set of 8).

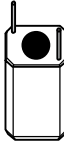
Ordering information

Description	Order no.
Rotor A-4-44	
Rotor A-4-44, incl. 4 × 100 mL rectangular buckets	5804 709.004
Rotor A-4-44, incl. four 2 × 50 mL buckets	5804 719.000
Buckets for Rotor A-4-44	
Bucket, 100 mL rectangular, set of 4	5804 741.005
Bucket, 2 × 50 mL, set of 4	5804 706.005
Accessories	
Aerosol-tight cap*1 for 100 mL rectangular bucket, set of 2	5804 712.005

								
*3	*3			*3	*3	*3		
7-18	18-30	50 mL conical	50 mL conical, skirted	30-50	50-75	80-100		
20	26	31	31	31	35	45		
107	110	122	122	122	119	114		
104	100	-	-	119	-	108	108	100
								
4/16	2/8	2/8	1/4	1/4	5804 737.008	1/4	1/4	1/4
flat with rubber mat	flat with rubber mat	flat w/conical form insert*6	conical	conical	flat with rubber mat	flat with rubber mat	flat with rubber mat	
15.0	15.0	16.1	15.5	15.7	15.0	15.0	15.0	
4,200	4,200	4,500	4,300	4,400	4,200	4,200	4,200	
5804 756.002	5804 757.009	5804 706.005*6	5804 758.005	5804 718.003	5804 759.001	5804 760.000	5804 761.006	

Rotor A-2-DWP-AT and A-2-DWP



Aerosol-tight*¹ deepwell plate Rotor A-2-DWP-AT*²

- > For use in Centrifuge 5810/5810 R only
- > Max. speed: 3,486 × g (4,500 rpm)
- > Rotor can handle up to
 - 2 × 6 MTP
 - 2 × 2 DWP
 - 2 × 1 Filtration plate kits
- > Maximum loading height of 67 mm (89 mm without lid)
- > Rotor comes with aerosol-tight caps*¹ for safe centrifugation of hazardous samples
- > Rotor and buckets are autoclavable

Deepwell plate Rotor A-2-DWP

- > For use in Centrifuge 5804/5804 R and 5810/5810 R
- > Max. speed: 2,250 × g (3,700 rpm)
- > Rotor can handle up to
 - 2 × 5 MTP
 - 2 × 4 Cell culture plates
 - 2 × 2 DWP
 - 2 × 1 Filtration plate kits
- > Maximum loading height of 89 mm
- > Rotor and buckets are autoclavable

Ordering information

Description	Order no.
Aerosol-tight deepwell plate Rotor A-2-DWP-AT*²	
Rotor A-2-DWP-AT, incl. buckets, aerosol-tight caps and plate carrier	5820 710.004
Deepwell plate Rotor A-2-DWP	
Rotor A-2-DWP, incl. 2 deepwell plate buckets	5804 740.009

*¹ Aerosol-tightness is tested and certified by Public Health England, Porton Down, UK.

*² Please note that a software upgrade may be necessary for older centrifuges when using Rotor A-2-DWP-AT. Please contact your local Eppendorf organization or dealer for further information.

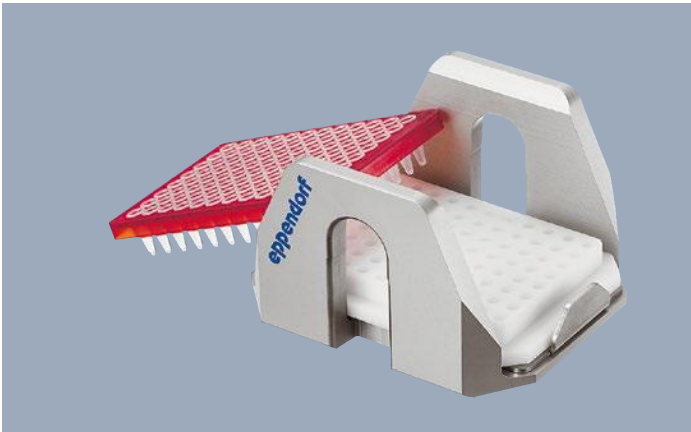

PCR plate adapter (PCR 96)

- > PCR plate adapters are designed to support thin-walled PCR plate wells during centrifugation
- > Available for 96-well and 384-well PCR plates
- > Adapters can be used in all Eppendorf plate rotors

IsoRack adapter

- > IsoRack adapters to support 0.5 mL and 1.5/2 mL IsoRacks during centrifugation
- > Adapters can be used in Eppendorf plate rotors A-2-DWP, A-4-81-MTP/Flex and S-4-104



Cell culture flask adapter

- > Adapter to spin down cell cultures directly in a cell culture flask
- > Suitable for 25 cm² flasks
- > Adapters can be used with Rotor A-4-81-MTP/Flex

CombiSlide adapter

- > Designed for drying slides after hybridization experiments
- > Adapter can hold up to 12 regular glass slides
- > Removable inserts allow centrifugation of glass slides across and parallel to the direction of rotation
- > Adapters can be used in all Eppendorf plate rotors

Ordering information

Description	Order no.
Adapter PCR 96-well plate, set of 2	5825 711.009
Adapter PCR 384-well plate, set of 2	5825 713.001
Adapter, for cell culture flasks, set of 2	5825 719.000
Adapter, for IsoRack 24 × 0.5 mL tubes, set of 2	5825 708.008
Adapter, for IsoRack 24 × 1.5/2 mL tubes, set of 2	5825 709.004
CombiSlide® adapter, for up to 12 glass slides, set of 2	5825 706.005











Rotor F-34-6-38

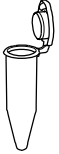

Product features

- > High-speed rotor for molecular biology applications in tubes from 0.2 mL to 85 mL
- > Max. speed 18,500 × g (12,000 rpm) in Centrifuge 5810 R or 15,500 × g (11,000 rpm) in 5804/5804R/5810*¹
- > Low rotor weight (3.2 kg) for easy handling
- > 34° borehole angle reduces pellet smears along tube wall
- > Anodized aluminum for high chemical resistance
- > Rotor, lid, and adapters are autoclavable







*¹ Rotors F-34-6-38 and FA-45-6-30 maintain 4°C at 11,000 rpm.





Tube					
Common volumes (mL)	1.5/2	2–5 13 × 75 mm	4–7 13 × 100 mm	4–10	Eppendorf Tubes® 5.0 mL
Max. tube diameter (Ø mm)	11	13	13	16	17
Max. tube height for use lid (mm)	110	90	110	112	104
Adapter options for Rotor F-34-6-38					
Capacity per adapter/rotor	4/24	3/18	3/18	2/12	1/6
Adapter bottom shape	round	flat	flat	round	conical
Centrifugation radius (cm)	11.3	10.6	11.4	11.2	10.5
RCF (g-force) at					
at 12,100 rpm (5810 R)	18,200	17,070	18,350	18,000	16,824
at 11,000 rpm (5804/5804 R/5810)	15,300	14,340	15,420	15,150	14,150
Order no. (set of 2)	5804 770.005	5804 738.004	5804 739.000	5804 771.001	5804 777.000

*² Nominal tube volume as published by the tube manufacturer.

Ordering information

Description	Order no.
Rotor F-34-6-38 for 6 × 85 mL tubes incl. rotor lid	5804 727.002

					
15 mL conical	15-18	20-30	50	50 mL conical	85*2
17	18	26	29	29	38
123	123	123	123	121	121

					no adapter needed
1/6 conical	1/6 round	1/6 round	1/6 round	1/6 conical	1/6 round
10.7	10.9	11.0	11.2	10.8	11.5
17,200 14,450	17,550 14,750	17,700 14,900	18,000 15,150	17,400 14,600	18,500 15,500
5804 776.003	5804 772.008	5804 773.004	5804 774.000	5804 775.007	-

Rotor FA-45-6-30









Product features

- > High-speed rotor for applications in tubes from 5–50 mL
- > Max. speed 20,130 × g (12,100 rpm) in Centrifuge 5810 R or 16,639 × g (11,000 rpm) in 5804/5804R/5810*1
- > Eppendorf QuickLock rotor lid for fast lid locking
- > Aerosol-tight*2 for safe centrifugation of hazardous samples
- > Low rotor weight (3.2 kg) for easy lifting
- > Anodized aluminum for high chemical resistance
- > 45° borehole angle minimizes pellets smear
- > Rotor, lid, and adapters are autoclavable

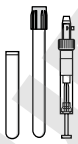
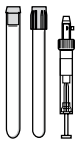
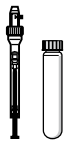
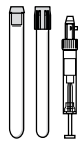
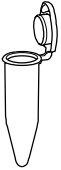
*1 Rotors F-34-6-38 and FA-45-6-30 maintain 4°C at 11,000 rpm.
 *2 Aerosol-tightness tested by Public Health England, Porton Down, UK.

Ordering information

Description	Order no.
Rotor FA-45-6-30*3, incl. aerosol-tight Eppendorf QuickLock® lid	5820 715.006

Tube					
Common volumes (mL)	2.6–5 13 × 75 mm	4–8 13 × 100 mm	5.5–10 16 × 75 mm	7.5–12 16 × 100 mm	Eppendorf Tubes® 5.0 mL
Max. tube diameter (Ø mm)	13	13	16	16	17
Max. tube height for use with aerosol-tight lid*1 (mm)	119	119	119	119	121
Adapter options for Rotor FA-45-6-30					
Capacity per adapter/rotor	1/6	1/6	1/6	1/6	1/6
Adapter bottom shape	round	round	round	round	conical
Centrifugation radius (cm)	12.0	12.0	12.0	12.0	12.1
RCF (g-force) at at 12,100 rpm (5810 R) at 11,000 rpm (5804/5804 R/5810)	19,246 16,233	19,246 16,233	19,246 16,233	19,246 16,233	19,806 16,369
Order no. (set of 2)	5820 726.008	5820 725.001	5820 728.000	5820 727.004	5820 730.005









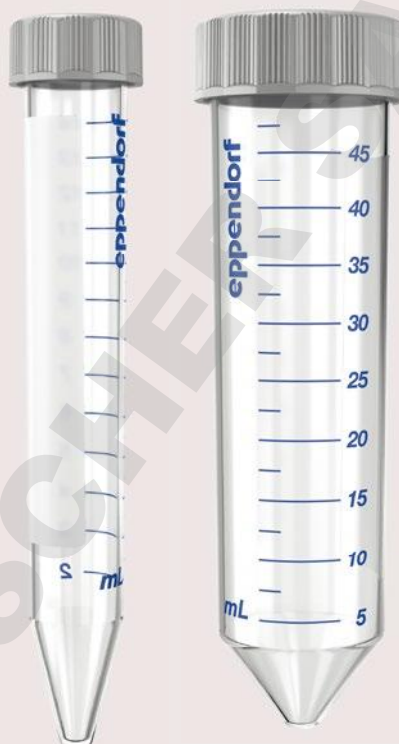

*3 Please note that a software upgrade may be necessary for older centrifuges when using Rotor FA-45-6-30.
 Please contact your local Eppendorf organization or dealer for further information.

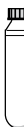
Eppendorf Conical Tubes

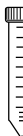
Whether centrifugation, mixing, or other applications – the Eppendorf Conical Tubes 15 mL and 50 mL will perfectly fit into your workflows. They represent the next step in Eppendorf’s comprehensive system solutions in liquid, sample, and cell handling.

More information: www.eppendorf.com/conicals



					
7-17	15 mL conical	15-18	20-30	35	50 mL conical
17.5	17	18	26	29	31
122	125	125	125	125	121
					no adapter needed
1/6 round	1/6 conical	1/6 round	1/6 round	1/6 conical	1/6 conical
12.0	12.0	12.0	10.5	11.2	12.3
19,246 16,233	19,246 16,223	19,246 16,223	17,187 14,204	18,333 16,161	20,130 16,639
5820 729.007	5820 717.009	5820 720.000	5820 721.006	5820 722.002	–

Rotor F-35-48-17 and FA-45-20-17



Rotor F-35-48-17*1

- > High-capacity fixed-angle rotor for 15 mL conical and glass tubes
- > Max. speed: 5,005 × g (5,500 rpm)
- > Form inserts for 15 mL conical tubes



Rotor FA-45-20-17*1

- > 20 places for Eppendorf Tubes® 5.0 mL
- > Max. speed: 20,913 × g (13,100 rpm)
- > Eppendorf QuickLock rotor lid for fast lid locking
- > Rotor, lid and adapters are autoclavable
- > Anodized aluminum for high chemical resistance

Ordering information

Description	Order no.
Fixed-angle Rotor F-35-48-17	
Includes 48 steel sleeves for 15 mL tubes, with 40 conical inserts and 48 rubber mats	5820 772.000
Includes 24 steel sleeves for 15 mL tubes, with 24 conical inserts and 24 rubber mats	5820 771.003
Fixed-angle rotor FA-45-20-17	
Rotor FA-45-20-17, 20 × 5.0 mL, incl. aerosol-tight Eppendorf QuickLock® rotor lid	5820 765.003
Adapter for 1.5/2.0 mL tubes, set of 4	5820 768.002
Adapter for cryogenic vials, set of 4	5820 769.009
Adapter for HPLC tubes, set of 4	5820 770.007

*1 Please note that a software upgrade will be necessary for older centrifuges when using Rotor F-35-48-17 or FA-45-20-17. Please contact your local Eppendorf organization or dealer for further information.



Rotors F-45-30-11 and FA-45-30-11

- > 30 places for 1.5/2.0 mL tubes
- > Max. speed: 20,800 × g (14,000 rpm)
- > Rotor FA-45-30-11 comes with aerosol-tight*2 lid for safe centrifugation of hazardous samples
- > Rotors and lids are autoclavable

Rotor FA-45-48-11*3

- > 48 places for 1.5/2.0 mL tubes
- > Max. speed: 19,083 × g (max. 13,000 rpm)
- > Eppendorf QuickLock rotor lid for fast lid locking
- > Aerosol-tight*2 for safe centrifugation of hazardous samples
- > Anodized aluminum for high chemical resistance
- > Rotor and lid are autoclavable



Drum Rotor T-60-11

- > High capacity for 60 × 1.5/2.0 mL tubes
- > Max. speed: 16,400 × g (14,000 rpm)
- > Horizontal centrifugation for pellet formation at tube bottom—ideal for low sample quantities

Rotor F-45-48-PCR

- > Accommodates up to 6 × 5/8-tube PCR strips or 48 × 0.2 mL PCR tubes
- > Safe and easy handling without additional lid
- > Max. speed: 15,350 × g (12,000 rpm)



Ordering information

Description	Order no.
Rotor FA-45-48-11, incl. aerosol-tight Eppendorf QuickLock® rotor lid	5820 760.001
Rotor FA-45-30-11, 30 × 1.5/2.0 mL, with aluminum lid, aerosol-tight*1	5804 726.006
Rotor F-45-30-11, 30 × 1.5/2.0 mL, with aluminum lid	5804 715.004
Adapter for 0.2 mL PCR tubes (for 1.5/2 mL rotors), set of 6	5425 715.005
Adapter for 0.4 mL tubes (for 1.5/2 mL rotors), set of 6	5425 717.008
Adapter for 0.5 mL tubes (for 1.5/2 mL rotors), set of 6	5425 716.001
Adapter for BD Microtainer® (for 1.5/2 mL rotors), set of 6	5425 716.001
Drum rotor T-60-11, with lid, without adapters	5804 730.003
Adapter for 10 × 1.5/2 mL tubes (Ø 11 mm), set of 6	5804 731.000
Adapter for 20 × 0.4 mL tubes (Ø 6 mm), set of 6	5804 732.006
Rotor F-45-48-PCR, for 6 × 8-tube PCR strips	5804 735.005

*2 Aerosol-tightness is tested and certified by Public Health England, Porton Down, UK.

*3 Please note that a software upgrade will be necessary for older centrifuges when using Rotor FA-45-48-11.

Please contact your local Eppendorf organization or dealer for further information.

Rolling Cabinet



If space is a limited resource in your lab, Eppendorf's rolling cabinet can give you the freedom and flexibility to use your Centrifuge 5804/5804 R or 5810/5810 R wherever you need it. Use the rolling cabinet if there is not enough space on the regular lab bench or to transport and use the centrifuge in other labs.

The included drawer provides extra storage space for your rotors and adapters.

- > Rolling cabinet with closed centrifuge fits under standard 90 cm lab benches
- > With 4 castors (2 lockable) and drawer
- > Dimensions: W x D x H: 70 x 62 x 45 cm



Watch video!

Ordering information

Description	Order no.
Rolling cabinet, for Centrifuge 5804/5804 R and 5810/5810 R	5821 020.010

Centrifuge 5804/5804 R and 5810/5810 R

Technical specifications

Description	Centrifuge 5804	Centrifuge 5804 R	Centrifuge 5810	Centrifuge 5810 R
Max. rcf				
> Fixed-angle rotor	20,913 × g	20,913 × g	20,913 × g	20,913 × g
> Swing-bucket rotor	4,500 × g	4,500 × g	4,500 × g	4,500 × g
> Plate rotor	2,250 × g	2,250 × g	3,486 × g	3,486 × g
Speed	200–14,000 rpm (in 10 rpm increments)			
Max. capacity	4 × 250 mL	4 × 250 mL	4 × 750 mL	4 × 750 mL
Rotor options	12	12	18	18
Accel./Braking ramps	10/10			
Programs	35 user programs			
Timer	1 min. to 99 min, with continuous mode, short spin			
Temperature control range	N/A	–9 °C to 40 °C	N/A	–9 °C to 40 °C
Noise level				
> Rotor S-4-104 (4 × 750 mL)			<70 dB(A)	<56 dB(A)
> Rotor S-4-72 (4 × 250 mL)	<62 dB(A)	<58 dB(A)		
> Rotor FA-45-6-30 (6 × 50 mL)	<55 dB(A)	<54 dB(A)	<56 dB(A)	<55 dB(A)
Power supply	230 V/50–60 Hz			
Power requirement	Max. 900 W	Max. 1,650 W	Max. 900 W	Max. 1,650 W
Dimensions (W × D × H)	47 × 55 × 34 cm	64 × 55 × 34 cm	54 × 61 × 35 cm	70 × 61 × 35 cm
Access height	28 cm	28 cm	28 cm	28 cm
Height with open lid	74 cm	74 cm	80 cm	80 cm
Weight without rotor	55 kg	80 kg	68 kg	99 kg

Centrifuge Packages



Ordering information

Cell culture centrifuge packages*

	Max. capacity of conical tubes per rotor	Order no.
Centrifuge 5804, with Rotor A-4-44 incl. adapters for 15 mL/50 mL conical tubes	16 × 15 mL / 4 × 50 mL	5804 000.320
Centrifuge 5804 R, refrigerated, with Rotor A-4-44 incl. adapters for 15 mL/50 mL conical tubes	16 × 15 mL / 4 × 50 mL	5805 000.320
Centrifuge 5804, with Rotor S-4-72 incl. adapters for 15 mL/50 mL conical tubes	32 × 15 mL / 16 × 50 mL	5804 000.520
Centrifuge 5804 R, refrigerated, with Rotor S-4-72 incl. adapters for 15 mL/50 mL conical tubes	32 × 15 mL / 16 × 50 mL	5805 000.620
Centrifuge 5810, with Rotor A-4-62 incl. adapters for 15 mL/50 mL conical tubes	36 × 15 mL / 16 × 50 mL	5810 000.320
Centrifuge 5810 R, refrigerated, with Rotor A-4-62 incl. adapters for 15 mL/50 mL conical tubes	36 × 15 mL / 16 × 50 mL	5811 000.325
Centrifuge 5810, with Rotor A-4-81 incl. adapters for 15 mL/50 mL conical tubes	48 × 15 mL / 20 × 50 mL	5810 000.420
Centrifuge 5810 R, refrigerated, with Rotor A-4-81 incl. adapters for 15 mL/50 mL conical tubes	48 × 15 mL / 20 × 50 mL	5811 000.420
Centrifuge 5810, with Rotor S-4-104 incl. adapters for 15 mL/50 mL conical tubes	56 × 15 mL / 28 × 50 mL	5810 000.525
Centrifuge 5810 R, refrigerated, with Rotor S-4-104 incl. adapters for 15 mL/50 mL conical tubes	56 × 15 mL / 28 × 50 mL	5811 000.620

Centrifuge packages for round-bottom tubes

	Max. capacity of round-bottom tubes per rotor	Order no.
Centrifuge 5810, with Rotor S-4-104 incl. adapters for round-bottom tubes with diameter 13/16 mm	92 × 13 mm / 80 × 16 mm	5810 000.620
Centrifuge 5810 R, refrigerated, with Rotor S-4-104 incl. adapters for round-bottom tubes with diameter 13/16 mm	92 × 13 mm / 80 × 16 mm	5811 000.820

*230 V/50–60 Hz

Technical specifications subject to change. Errors and omissions excepted.

Centrifuge Family Overview

Eppendorf Microcentrifuges



	MiniSpin®	MiniSpin® plus	5418 R	5424 R	5427 R	5430	5430 R
Model	Entry-level		Medium capacity	The laboratory standard	High throughput	Microcentrifuge with multipurpose capabilities	
Max. Capacity	12 × 1.5/2 mL		18 × 1.5/2 mL	24 × 1.5/2 mL	48 × 1.5/2 mL	48 × 1.5/2 mL (6 × 15/50 mL, 2 × MTP)	
Max. speed (RCF)	12,100 × g	14,100 × g	16,873 × g	21,130 × g	25,000 × g	30,130 × g	
Max. rpm	13,400	14,500	14,000	15,000	16,220	17,500	
Rotor options	2		1	4	9	12	
Refrigerated	–	–	0 °C to 40 °C	–10 °C to 40 °C	–10 °C to 40 °C	–	–11 °C to 40 °C
Ordering no.	5452 000.010	5453 000.015	5401 000.010	5404 000.610	5409 000.010	5427 000.610	5428 000.610

Eppendorf Multipurpose Centrifuges



	5702	5702 R	5702 RH	5804	5804 R	5810	5810 R	5910 R	5920 R
Model	Low speed centrifuge for medium capacity needs		Active heating and cooling for high temperature accuracy	Compact high speed centrifuge for medium capacity needs. With swing-bucket rotor and deepwell plate capacity		The workhorse for medium to high-throughput laboratories: Highly versatile, high speed and high plate capacity		High throughput, high performance	Bench-top centrifuge with floor-standing capabilities
Capacity	4 × 100 mL			4 × 250 mL		4 × 750 mL		4 × 750 mL	4 × 1,000 mL
> Conical tubes	20 × 15 mL/4 × 50 mL			40 × 15 mL/16 × 50 mL		56 × 15 mL/28 × 50 mL		64 × 15 mL/ 36 × 50 mL	108 × 15 mL/ 52 × 50 mL
> Blood collection tubes	36 × 13 mm/30 × 16 mm			56 × 13 mm/52 × 16 mm		100 × 13 mm/80 × 16 mm		120 × 13 mm/ 104 × 16 mm	196 × 13 mm/ 148 × 16 mm
> Plates	–			10 × MTP/2 × DWP		16 × MTP/4 × DWP		20 × MTP/ 4 × DWP	28 × MTP/ 8 × DWP
Max. speed (RCF)	3,000 × g			20,913 × g		20,913 × g		22,132 × g	21,194 × g
Max. rpm	4,400			14,000		14,000		14,000	13,700
Rotor options	6			12		18		–	–
Refrigerated	–	–9 °C to 40 °C	–9 °C to 42 °C	–	–9 °C to 40 °C	–	–9 °C to 40 °C	–11 °C to 40 °C	–11 °C to 40 °C
Ordering no.	5702 000.010	5703 000.010	5704 000.010	5804 000.010	5805 000.010	5810 000.010	5811 000.015	5942 000.010	5948 000.010

Technical specifications subject to change. Errors and omissions excepted.

Your local distributor: www.eppendorf.com/contact
 Eppendorf AG 22339 · Hamburg · Germany
 E-mail: eppendorf@eppendorf.com · www.eppendorf.com

www.eppendorf.com/centrifugation