

General Lab Products



Reliable Performance

Centrifuge 5804/5804 R and Centrifuge 5810/5810 R



Introducing the Eppendorf 58xx Centrifuge Family

Reliable performance

The Eppendorf approach to product development is, and always has been, about giving you more. More quality, more innovation. All of our centrifuges personalize this philosophy.

They all go beyond speed and capacity to offer you unparalleled ergonomic operation, excellent temperature control, and outstanding product quality. Each centrifuge is

designed to operate at low noise levels for a relaxing work environment and offers soft-touch lid closure for ease of use and a low profile for easy loading and unloading of samples.

Refrigerated centrifuge models have exclusive features such as ECO shut-off and dynamic compressor control for maximum sample protection and energy savings.

The Benchmark in Ergonomic Operation

Low profile for easy operation

The 58xx centrifuges are designed with a particularly low height in mind. Not only does the low profile facilitate easy loading and unloading, it also allows everyone in the lab to easily reach the open centrifuge lid.



Soft-touch lid closure

There's no need to exert unnecessary high force when closing the centrifuge lid. The soft-touch lid closure allows closing the centrifuge with ease.



Eppendorf QuickLock® caps for one-hand operation

Aerosol-tight caps provide the needed safety when working with potentially hazardous samples. The caps for the 4 × 750 mL swing-bucket rotor allow for easy, one-handed operation. Its unique design allows the closed bucket to be carried securely to the biosafety cabinet.



Eppendorf QuickLock® rotor lids for ergonomic lid locking

Our aerosol-tight QuickLock rotors close with only ¼ of a turn. This not only saves you time during every day use, it also takes repetitive stress off your wrist.



Centrifuge 5804/5804 R



Centrifuge 5804 with plate rotor A-2-DWP



Centrifuge 5804 R with rotor S-4-72 (4 x 250 mL)

The Centrifuge 5804/5804 R is a high speed centrifuge for medium capacity needs. It allows for applications in tubes up to 250 mL and offers additional swing-bucket and fixed-angle rotors as well as deepwell plate capacity for increased versatility. Common rotors for Centrifuge 5804/5804 R include:



S-4-72
4 x 250 mL swing-bucket rotor.
Max. speed 3,234 x g (4,200 rpm).

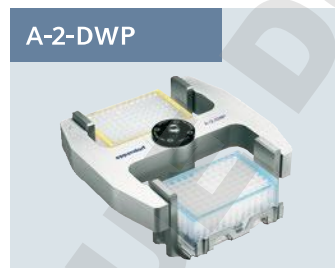

A-2-DWP
2-place deepwell plate rotor
for plates up to 89 mm
loading height. Max. speed
2,250 x g (3,750 rpm).



FA-45-6-30
6 x 50 mL conical tube rotor with
aerosol-tight QuickLock lid for
tubes from 5–50 mL. Max. speed
16,639 x g (11,000 rpm).



FA-45-30-11
30 x 1.5/2 mL micro tube rotor
with aerosol-tight lid for safe
centrifugation of hazardous
samples. Max. speed 20,800 x g
(14,000 rpm).

Eppendorf recognizes its responsibility as a global citizen. Protecting the environment is critical to the conservation of precious natural resources. The Eppendorf epGreen® initiative is another example of our commitment to social responsibility. Our goal is to constantly reduce the environmental impact of our business operations and the products that we produce.

Centrifuges in general

- > Use of brushless induction motors to provide maintenance-free operation, eliminating carbon particle emissions
- > Rotors are mostly made of recyclable aluminum
- > Optimized sound design for low noise levels to benefit your work environment
- > 100 % recyclable packaging material

Centrifuge 5810/5810 R



Centrifuge 5810 with rotor S-4-104 (4 × 750 mL)



Centrifuge 5810 R with rotor S-4-104 (4 × 750 mL)

The Centrifuge 5810/5810 R is a workhorse for medium to high-throughput laboratories. It combines extraordinary versatility and capacity for both tubes and plates with an extraordinary compact footprint. Common rotors for Centrifuge 5810/5810 R include:

S-4-104



4 × 750 mL swing-bucket rotor with optional aerosol-tight QuickLock caps. Max. speed 3,214 × *g* (3,900 rpm).

Rotor S-4-104 is also available with plate buckets and optional aerosol-tight QuickLock caps.

FA-45-6-30



6 × 50 mL conical tube rotor with aerosol-tight QuickLock lid for tubes from 5–50 mL. Max. speed 20,130 × *g* (12,000 rpm).

FA-45-48-11



48 × 1.5/2 mL micro tube rotor with aerosol-tight QuickLock rotor lid for safe centrifugation of hazardous samples. Max. speed 19,083 × *g* (13,000 rpm).

Refrigerated models additionally feature

- > Dynamic compressor control for precise cooling performance
- > CFC-free refrigerant with an ozone depletion potential (ODP) of zero
- > ECO shut-off deactivates the compressor after 8 hours of inactivity to reduce energy consumption and extend compressor life

Energy saving through 2nd generation of swing-bucket rotors*

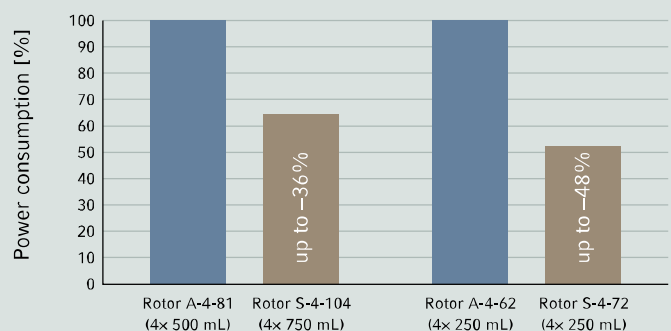

* based on internal testing with Centrifuge 5810 R, 230 V

Performance You Can Count On



> Watch video clips of Centrifuge 5810 R on our optimized webpage for mobile devices or www.eppendorf.com/centrifugation

Ergonomic lid operation

- > Soft-touch lid closure and low opening height for stress-free lid locking

Precise cooling performance

- > Dynamic compressor control with ECO shut-off function

Mixed loading capability

- > Rotors S-4-104 and A-4-81 provide mixed loading capability with plate and tube buckets for increased versatility

Quiet operation

- > All models are designed to operate at low noise levels for a relaxing work environment

Low access height (29 cm)

- > Easy loading/unloading of samples

Placement flexibility

- > Compact footprint
- > Low opening height for use under shelves
- > Rolling cabinet option available for use in crowded labs

Outstanding versatility for all your applications

- > Broad rotor and adapter selection to spin all commonly used tubes, bottles, flasks, and plates
- > High centrifugation speed up to $20,913 \times g$ (14,000 rpm) for applications in tubes from 0.2 to 750 mL
- > Aerosol-tight rotors (e.g. for potentially hazardous materials)

The benchmark for ergonomic operation

- > Low sound level to benefit your work environment
- > Low access height (29 cm) for easy loading/unloading
- > Centrifuge lid with soft-touch lid closure

Designed to fit in every lab

- > Compact footprint saves valuable bench space
- > Low lid opening height for use under shelves
- > Automatic rotor recognition and imbalance detection for maximum operational safety

Advanced temperature management for maximum sample protection and energy efficiency

- > Temperature range from $-9\text{ }^{\circ}\text{C}$ to $40\text{ }^{\circ}\text{C}$
- > Maintains constant $4\text{ }^{\circ}\text{C}$, even at maximum speed (rotors F-34-6-38 and FA-45-6-30 maintain $4\text{ }^{\circ}\text{C}$ at 11,000 rpm)
- > FastTemp function for quick pre-cooling
- > Continuous cooling maintains a constant temperature after the run has been completed - your samples stay cool
- > ECO shut-off engages after 8 hours of non-use to reduce energy consumption and extend compressor life
- > Dynamic compressor control (DCC) technology for precise cooling performance

Rotor Design at Its Best

Eppendorf's 2nd generation of swing-bucket and fixed-angle rotors elevate your centrifuge performance to a new level.

Enjoy unique product features that improve handling and performance.

Swing-bucket rotors

Improved energy efficiency

The round buckets have been designed to be especially aerodynamic. The result is a more efficient design that reduces power consumption by up to 48 %.

Longer rotor lifetime

The 2nd rotor generation of both swing-bucket and fixed-angle rotors has been designed with a particularly long lifetime in mind.

Eppendorf QuickLock® caps for one-hand operation

- > Significantly improved handling, easy operation with one hand
- > Handle allows the closed bucket to be carried to the biosafety cabinet where it can be opened in a safe environment
- > Aerosol-tightness has been tested and verified by Public Health England, Porton Down, UK



Fixed-angle rotors

Low rotor weight

Eppendorf's fixed-angle rotors are among the lightest in the industry to improve handling and operational safety. Light-weight rotors cause less wear and tear on the motor and allow for faster acceleration and braking times.

Eppendorf QuickLock® lids for ergonomic lid locking

Our aerosol-tight QuickLock rotors close with only $\frac{1}{4}$ of a turn. This not only saves you time during every day use, it also takes repetitive stress off your wrist.

Superior temperature control

Aluminum, with its high heat conductivity, allows fast pre-cooling and accurate temperature control in refrigerated centrifuges.

Additional rotor features

- > All rotors are anodized for high chemical resistance and to prevent corrosion
- > Optimized design of rotor boreholes and adapters provide optimal support for high-speed centrifugation of tubes
- > Aluminum rotors are recyclable







Cross section of Rotor FA-45-6-30

(6 × 50 mL conical) showing the light-weight design. All metal not needed for safety or performance is hollowed out to reduce weight and improve handling.

Exceptional Versatility

Overview of the main rotors

| Rotor image | | | | | |
|---|---|---|--|---|---|
| |  |  |  |  |  |
| Rotor name | S-4-104 (4 x 750 mL) aerosol-tight QuickLock caps | A-4-81 (4 x 500 mL) aerosol-tight | A-4-62 (4 x 250 mL) aerosol-tight | S-4-72 (4 x 250 mL) | A-4-44 (4 x 100 mL) aerosol-tight |
| 5804/ 5804 R | | | | x | x |
| 5810/ 5810 R | x | x | x | x | x |
| Positioning | High-capacity swing- bucket rotor | Medium to high capacity swing- bucket rotor | Economic swing- bucket rotor for medium capacity | Economic swing- bucket rotor for medium capacity | High-speed swing- bucket rotor |
| Aerosol-tightness | yes | yes | yes | no | yes |
| Max. speed (RCF) | 3,214 | 3,220 | 3,220 | 3,234 | 4,500 |
| Max. speed (rpm) | 3,900 | 4,000 | 4,000 | 4,200 | 5,000 |
| Volume range | 0.2–750 mL MTP/DWP | 0.2–500 mL, MTP/DWP | 0.2–250 mL, MTP/DWP | 0.2–250 mL | 0.2–100 mL |
| Eppendorf Tubes® 5.0 mL and 15 mL conical | 56 | 48 | 36 | 32 | 16 |
| 50 mL conical | 28 | 20/28* ¹ | 16 | 16 | 4/8* ¹ |
| 13 mm blood tube | 92 | 100 | 60 | 56 | 36 |
| 16 mm blood tube | 80 | 64 | 48 | 52 | 28 |
| 1.5/2.0 mL micro tube | 200 | 96 | 64 | 104 | 48 |
| MTP | 16 | 16 | 12 | | |
| DWP | 4 | 4 | 4 | | |

*¹ Maximum capacity with dedicated 50 mL bucket.



epServices
for premium performance

Centrifuge Performance Plans

An annual inspection and maintenance of centrifuges and rotors by an Eppendorf certified service technician is highly recommended to ensure a safe working environment.

■ ESSENTIAL CHECK

> Check of all fundamental functions of the product

■ PREMIUM SERVICE

> Complete maintenance and repair service agreement solution for your peace of mind

■ ADVANCED MAINTENANCE

> Preventive maintenance service to meet manufacturer specifications



| A-2-DWP-AT (2 x 6 MTP) aerosol-tight | A-2-DWP (2 x 5 MTP) | F-34-6-38 (6 x 85 mL) | FA-45-6-30 (6 x 50 mL) aerosol-tight QuickLock lid | FA-45-48-11 (48 x 2 mL) aerosol-tight QuickLock lid |
|--|-------------------------------|---|---|---|
| | x | x | x | x |
| x | x | x | x | x |
| Aerosol-tight deepwell plate rotor for safe centrifugation of hazardous samples. | Economic deepwell plate rotor | High-speed rotor suitable for molecular biology applications in tubes up to 85 mL | Aerosol-tight high-speed rotor for safe centrifugation of hazardous samples | Aerosol-tight microcentrifuge tube rotor for safe centrifugation of hazardous samples |
| yes | no | no | yes | yes |
| 3,486 | 2,250 | 18,500/15,500*2 | 20,130/16,639*2 | 19,083 |
| 4,500 | 3,700 | 12,000/11,000*2 | 12,100/11,000*2 | 13,000 |
| MTP/DWP | MTP/DWP | 0.2–85 mL | 5–50 mL | 0.2–2.0 mL |
| | | 6 | 6 | |
| | | 6 | 6 | |
| | | 18 | 6 | |
| | | 12 | 6 | |
| 48 | 48 | 24 | | 48 |
| 12 | 10 | | | |
| 4 | 4 | | | |

*2 Max. speed in Centrifuge 5810 R, lower speed applies to Centrifuge 5804/5804R/5810.

Certification Services

Our Installation Qualification (IQ) and Operational Qualification (OQ) services make sure that temperature accuracy, rotational speed verification and operating time meet manufacturer's specifications.

Over the years, all rotor structures will eventually suffer from fatigue due to stress of high numbers of cycles. If not maintained correctly, surface scratches can lead to microscopic and then to critical cracks. Qualified inspection will detect damages early in order to prevent further equipment failure. Our service includes cleaning, instructions for proper care, and visual examination of rotors and adapters

determining if the rotor is safe for further operation or needs to be replaced.

The Performance Plans feature

- > Manufacturer-specific test procedures
- > GLP supporting documentation

Value of service

- > Highest degree of security in your lab
- > Longer service life of the system







> Further information and local offers in your country: www.eppendorf.com/epServices

Rotor S-4-104

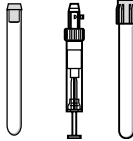
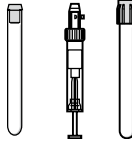
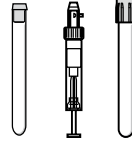

Product features

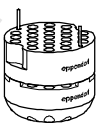
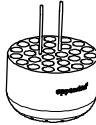
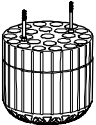
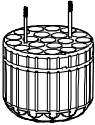
- > High capacity swing-bucket rotor with max. speed 3,214 × g (3,900 rpm)
- > Rotor S-4-104 accommodates tubes and bottles from 0.2 mL to 750 mL as well as plates
- > Aerodynamic round bucket design for up to 36 % energy savings compared to Rotor A-4-81
- > Mixed loading with 2 plate buckets and 2 round tube buckets allows for increased versatility
- > Aerosol-tight Eppendorf QuickLock caps for safe centrifugation of hazardous samples optionally available*1
- > Rotor life time: max. 100,000 cycles
- > Buckets, caps, and adapters are autoclavable

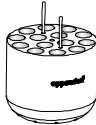
| Tube |  |  |  |  |  |  |
|--|---|---|---|--|---|---|
| Tube capacity (mL) | 1.5/2.0 | 12 x 75 mm, 5 mL FACS | 2.6–8 | 5.5–12 | 9 | 14 |
| Max. tube diameter (Ø mm) | 11 | 12 | 13 | 16 | 17.5 | 17.5 |
| Max. vessel height (mm) | 39 | 111 | 115 | 119 | 111 | 117 |
| Max. vessel height for use with aerosol-tight lid (mm)*2 | 39 | 100 | 108 | 114 | 106 | 112 |
| Adapter/bucket options for Rotor S-4-104 |  |  |  |  |  |  |
| Capacity per bucket/rotor | 50/200 | 27/108 | 23/92 | 20/80 | 20/80 | 14/56 |
| Adapter bottom shape | flat | round | round | round | round | round |
| Centrifugation radius (mm) | 188 | 175 | 179 | 180 | 179 | 185 |
| Max. RCF (g-force) | 3,197 | 2,976 | 3,044 | 3,061 | 3,044 | 3,146 |
| Order no. (set of 2) | 5825 740.009 | 5825 747.003 | 5825 738.004 | 5825 736.001 | 5825 743.008 | 5825 748.000 |

*1 Aerosol-tightness tested by Public Health England, Porton Down, UK.

*2 Exceeding the maximum tube length may reduce the loading capacity of the rotor. Please perform a manual swing-out test before starting the centrifuge run to make sure the tubes do not hit the rotor yoke.

*3 Please note that these conical bottles need to be used together with a conical form insert provided by the manufacturer.











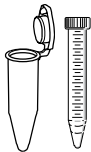

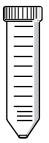

*4 Available as a set of 2 bottles (see ordering information).

*5 Please note that a software upgrade may be necessary for older centrifuges when using Rotor S-4-104.

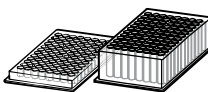
Please contact your local Eppendorf organization or dealer for further information

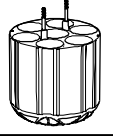
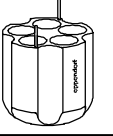
Ordering information

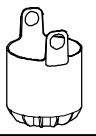
| Description | Order no. |
|--|--------------|
| Rotor S-4-104*5 | |
| Rotor S-4-104, incl. 4 × 750 mL round buckets | 5820 740.000 |
| Rotor S-4-104, incl. 4 × Plate bucket (aerosol-tight capable) | 5820 754.001 |
| Rotor S-4-104, without buckets | 5820 755.008 |
| Buckets for Rotor S-4-104*5 | |
| Plate bucket (aerosol-tight capable), incl. plate carrier, set of 4 | 5820 743.000 |
| Plate bucket (aerosol-tight capable), incl. plate carrier, set of 2 | 5820 744.006 |
| Accessories | |
| Aerosol-tight caps*1, for 750 mL round buckets, set of 2 | 5820 747.005 |
| Aerosol-tight caps*1, for Plate bucket (aerosol-tight capable), set of 2 | 5820 748.001 |
| 750 mL wide-mouth bottle, set of 2 | 5820 708.000 |

| | | | | | | | | |
|---|---|---|---|---|--|---|---|---|
|  |  |  |  |  |  |  |  |  |
| Eppendorf Tubes® 5.0 mL and 15 mL conical | 30 mL | 50 mL conical | 50 mL conical skirted | 175– 225 mL conical, Nunc® 250 mL conical | 250 mL flat | 500 mL Corning® | 750 mL Eppendorf bottle*4 (order no. 5820 708.000) | MTP, DWP, PCR plates |
| 17 | 25 | 31 | 31 | *3 | 62 | 98 | 104 | – |
| 125 | 111 | 122 | 120 | | 145 | 136 | 150 | 60 |
| 120 | 106 | 116 | 116 | | 125 | – | – | 45 |
|  |  |  |  |  |  |  |  | |
| 14/56 | 8/32 | 7/28 | 5/20 | 1/4 | 1/4 | 1/4 | 4/16 (MTP) 1/4 (DWP) | |
| conical | flat | conical | conical, skirted | flat | conical | flat | flat | |
| 188 | 174 | 187 | 178 | 183 | 187 | 185 | 151 | |
| 3,197 | 2,958 | 3,180 | 3,027 | 3,112 | 3,171 | 3,146 | 2,568 | |
| 5825 734.009 | 5825 755.006 | 5825 733.002 | 5825 732.006 | 5825 741.005 | 5825 745.000 | 5825 744.004 | 5820 744.006 | |





Rotor A-4-81



Product features

- > Swing-bucket rotor with max. speed 3,220 × g (4,000 rpm)
- > Rotor A-4-81 accommodates tubes and flasks from 0.2 mL to 500 mL as well as plates
- > Aerosol-tight caps*¹ for safe centrifugation of hazardous samples optionally available
- > Mixed loading with 2 plate buckets and 2 rectangular tube buckets allows for increased versatility
- > Rotor life time: max. 100,000 cycles
- > Buckets, caps, and adapters are autoclavable

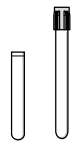
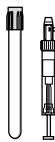
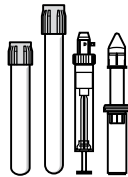
Tube

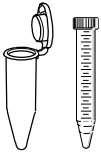
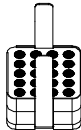
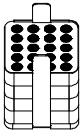
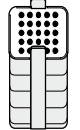
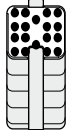
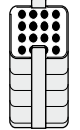
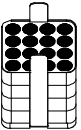
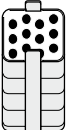
| |  |  |  |  |  |  |  |
|--|---|---|---|--|---|---|---|
| Tube capacity (mL) | 1.5/2 | 1.2–5 | 1.8–7 | 2.6–7 | 4–10 | 7–17 | Eppendorf Tubes® 5.0 mL and 15 mL conical |
| Max. tube diameter (Ø mm) | 11 | 11 | 13 | 13 | 16 | 17.5 | 17 |
| Max. vessel height (mm) ^{*2} | 118 | 118 | 118 | 118 | 118 (130 mm in 2 inner rows) ^{*2} | 118 (130 mm in 2 inner rows) ^{*2} | 122 |
| Max. vessel height for use with aerosol-tight lid ^{*1} (mm) | 108 | 108 | 108 | 108 | 108 (130 mm in 4 center pos.) ^{*2} | 108 (130 mm in 4 center pos.) ^{*2} | 120 |
| Adapter/bucket options for Rotor A-4-81 |  |  |  |  |  |  |  |
| Capacity per bucket/rotor | 20/80 | 20/80 | 25/100 | 18/72 | 16/64 | 16/64 | 12/48 |
| Adapter bottom shape | flat | flat with rubber mat | flat with rubber mat | flat with rubber mat | flat with rubber mat | flat with rubber mat | conical |
| Centrifugation radius (cm) | 16.5 | 16.8 | 16.8 | 16.8 | 16.8 | 16.8 | 17.3 |
| Max. RCF (g-force) | 2,950 | 3,000 | 3,000 | 3,000 | 3,000 | 3,000 | 3,100 |
| Order no. (set of 2) | 5810 745.004 | 5810 746.000 | 5810 720.001 | 5810 747.007 | 5810 748.003 | 5810 721.008 | 5810 722.004 |

^{*1} Aerosol-tightness tested by Public Health England, Porton Down, UK.













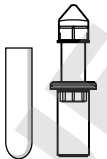

^{*2} Exceeding the maximum tube length may reduce the loading capacity of the rotor.

Please perform a manual swing-out test before starting the centrifuge run to make sure the tubes do not hit the rotor yoke.

^{*3} Only Centriprep® tube without locking lid.

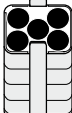
Ordering information

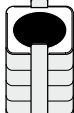
| Description | Order no. |
|--|--------------|
| Rotor A-4-81 | |
| Rotor A-4-81, incl. 4 × 500 mL rectangular buckets | 5810 718.007 |
| Rotor A-4-81, incl. 4 × MTP/Flex plate buckets | 5810 725.003 |
| Rotor A-4-81 without buckets | 5810 743.001 |
| Buckets for Rotor A-4-81 | |
| Bucket, 500 mL rectangular, set of 4 | 5810 730.007 |
| Bucket, 7 × 50 mL conical, set of 4 | 5825 730.003 |
| Bucket, MTP/Flex plates, set of 2 | 5810 742.005 |
| Bucket, MTP/Flex plates, set of 4 | 5810 741.009 |
| Accessories | |
| Aerosol-tight cap ² for 500 mL rectangular bucket, set of 2 | 5810 724.007 |
| Bottle 400 mL wide-mouth, includes stabilizing sleeves, set of 2 | 5810 729.009 |
| Bottle 500 mL wide-mouth, set of 2 | 5820 707.003 |

| | | | | | | | | | |
|---|---|---|---|---|---|---|---|---|---|
|  |  |  |  |  |  |  |  |  |  |
| 50 mL conical | 50 mL conical, skirted | 30–50 mL and 50 mL Centriprep [®] | 175–225 mL conical | 180–250 | 400 mL bottle* ⁵ (5810 729.009) | 500 mL bottle* ⁵ (5820 707.003) | MTP and PCR plates | Cell culture plates | DWP |
| 31 | 31 | 29 | 61 | 81 | 83 | – | – | – | |
| 122 | 122 | 122 | 133 | 135 | 135 | 60 | 60 | 60 | |
| 116 | – | 116 | – | – | 135 | – | – | – | |
|  |  |  |  |  | no adapter needed | See page 23 for additional adapters | | | |
| 5/20 conical | 7/28 conical | 5804 737.008 5/20 flat with rubber mat | 1/4 flat with rubber mat | 1/4 flat, rubber | – | 4/16 | 2/8 | 1/4 | |
| 17.3 | 18.0 | 17.3 | 17.3 | 18.0 | 18.0 | flat with rubber mat | | | |
| 3,100 | 3,250 | 3,100 | 3,100 | 3,220 | 3,220 | 2,900 | | | |
| 5810 723.000 | 5825 730.003 ⁷ | 5810 739.004 | 5825 722.000 | 5810 728.002 | – | 5810 742.005 | 5810 741.009* ⁶ | | |

⁴⁴ Please note that these conical flasks need to be used together with a conical form insert provided by the flask manufacturer.

⁴⁵ Available as a set of 2 flasks (see ordering information).

⁴⁶ Set of 4.







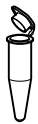
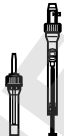
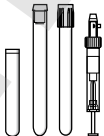
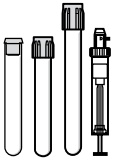
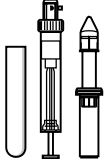

⁴⁷ 50 mL conical tubes skirted need to be ordered separately. Order no. 5804 737.008 (set of 8).

Rotor A-4-62

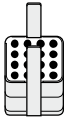
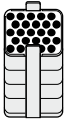
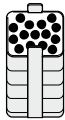

Product features

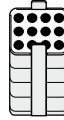
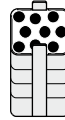
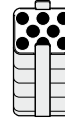
- > Economic swing-bucket rotor with speed up to $3,220 \times g$ (4,000 rpm)
- > Rotor A-4-62 accommodates tubes and flasks from 0.2 mL to 250 mL as well as plates
- > Aerosol-tight caps*¹ for safe centrifugation of hazardous samples optionally available
- > Rotor life time: max. 40,000 cycles
- > Rotor, buckets, caps, and adapters are autoclavable

| Tube |  |  |  |  |  |  |  |  |
|--|---|---|---|---|--|---|---|---|
| Tube capacity (mL) | 1.5/2 | 1.2-5 | 1.8-7 | 4-10 | 7-17 | Eppendorf Tube® 5.0 mL and 15 mL conical | 7-18 | 18-30 |
| Max. tube diameter (Ø mm) | 11 | 11 | 13 | 16 | 17.5 | 17 | 20 | 26 |
| Max. vessel height (mm)* ² | 122 | 123 | 121 | 121 (130 mm in 2 center rows)* ² | 118 (130 mm in 2 center rows)* ² | 127 | 126 | 119 |
| Max. vessel height for use with aerosol-tight lid* ¹ (mm) | 118 | 115 | 118 | 116 (130 mm in 2 inner pos.) | 114 (130 mm in 2 inner pos.) | 121 | 119 | 116 |
| Adapter/bucket options for Rotor A-4-62 |  |  |  |  |  |  |  |  |
| Capacity per bucket/rotor | 16/64 | 25/100 | 15/60 | 12/48 | 12/48 | 9/36 | 8/32 | 4/16 |
| Adapter bottom shape | flat | flat with rubber mat | flat with rubber mat | flat with rubber mat | flat with rubber mat | conical | flat with rubber mat | flat with rubber mat |
| Centrifugation radius (cm) | 17.1 | 17.3 | 17.3 | 17.3 | 17.3 | 17.8 | 17.3 | 17.3 |
| Max. RCF (g-force) | 3,000 | 3,050 | 3,050 | 3,050 | 3,050 | 3,150 | 3,050 | 3,050 |
| Order no. (set of 2) | 5810 751.004 | 5810 750.008 | 5810 752.000 | 5810 753.007 | 5810 754.003 | 5810 755.000 | 5810 756.006 | 5810 757.002 |















*¹ Aerosol-tightness tested by the Centre for Public Health England, Porton Down, UK.

*² Exceeding the maximum tube length may reduce the loading capacity of the rotor. Please perform a manual swing-out test before starting the centrifuge run to make sure the tubes do not hit the rotor yoke.

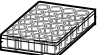
*³ For high g-forces we recommend using centrifuge tubes of Duran® glass.

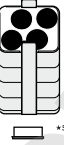
Ordering information

| Description | Order no. |
|---|--------------|
| Rotor A-4-62 | |
| Rotor A-4-62, incl. 4 × 250 mL rectangular buckets | 5810 709.008 |
| Rotor A-4-62, incl. 4 × MTP plate buckets | 5810 711.002 |
| Buckets for Rotor A-4-62 | |
| Bucket, 250 mL rectangular, set of 4 | 5810 716.004 |
| Bucket, MTP plates, set of 4 | 5810 702.003 |
| Accessories | |
| Aerosol-tight cap*1 for 250 mL rectangular bucket, set of 2 | 5810 710.006 |

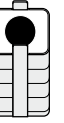
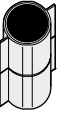
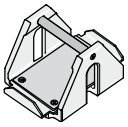
| | | | | | | | | | |
|---|---|---|---|---|--|---|---|---|---|
|  |  |  |  |  |  |  |  |  |  |
| 30–50 | 50 mL conical, skirted | 50 mL conical | 50–75 | 80–120 | 175–225 conical | 180–250 | MTP and PCR plates | Cell culture plates | DWP |
| 29 | 31 | 31 | 35 | 45 | 62 | – | – | – | – |
| 122 | 122 | 122 | 122 | 139 | 137 | 53 | 53 | 53 | – |
| 116 | – | – | 116 | 118 | 125 | 127 | – | – | – |
|  |  |  |  |  |  |  | | | |
| 5804 737.008 | | | | | | See page 23 for additional adapters | | | |
| 4/16 | 4/16 | 3/12 | 2/8 | 1/4 | 1/4 | 4/16 | 2/8 | 1/4 | |
| flat with rubber mat | flat w/conical form insert | conical | flat with rubber mat | flat with rubber mat | flat with rubber mat | flat with rubber mat | | | |
| 17.3 | 17.3 | 17.8 | 17.3 | 17.3 | 18.0 | 15.4 | | | |
| 3,050 | 3,050 | 3,150 | 3,050 | 3,050 | 3,200 | 2,750 | | | |
| 5810 759.005 | 5810 763.002 | 5810 758.009 | 5810 760.003 | 5810 761.000 | 5810 770.009 | 5810 702.003*6 | | | |

*4 Please note that these conical flasks need to be used together with a conical form insert provided by the manufacturer.

*5 Form inserts for 50 mL conical tubes skirted need to be ordered separately. Order no. 5804 737.008 (set of 8).





*6 Set of 4.

Rotor S-4-72

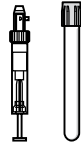
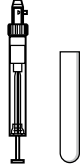
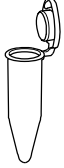
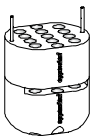
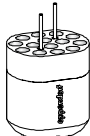

Product features

- > Medium capacity swing-bucket rotor with speed up to $3,234 \times g$ (4,200 rpm)
- > Broad range of adapters available to handle all common tube formats from 0.2 mL to 250 mL
- > Aerodynamic round bucket design for up to 48 % energy savings compared to Rotor A-4-62
- > Rotor life time: max. 60,000 cycles
- > Buckets and adapters are autoclavable

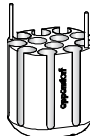
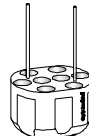
| Tube |  |  |  |  |  |
|--|---|---|--|---|---|
| Tube capacity (mL) | 1.5/2.0 | 2.6–8 mL | 5.5–12 | 9 | Eppendorf Tubes® 5.0 mL |
| Max. tube diameter (Ø mm) | 11 | 13 | 16 | 17.5 | 17 |
| Max. vessel height (mm)*1 | 43 | 115 | 112 | 113 | 60 |
| Max. vessel height for use with aerosol-tight lid*1 (mm) | – | – | – | – | – |
| Adapter options for Rotor S-4-72 |  |  |  |  |  |
| Capacity per bucket/rotor | 26/104 | 14/56 | 13/52 | 12/48 | 8/32 |
| Adapter bottom shape | flat | round | round | round | conical |
| Centrifugation radius (mm) | 159 | 159 | 157 | 158 | 163 |
| Max. RCF (g-force) | 3,136 | 3,136 | 3,096 | 3,116 | 3,215 |
| Order no. (set of 2) | 5804 794.001 | 5804 789.008 | 5804 791.002 | 5804 792.009 | 5804 793.005 |

*1 Exceeding the maximum tube length may reduce the loading capacity of the rotor.





*2 Please note that these conical flasks need to be used together with a conical form insert provided by the flask manufacturer.

*3 Please note that a software upgrade may be necessary for older centrifuges when using Rotor S-4-72.

Please contact your local Eppendorf organization or dealer for further information

Ordering information

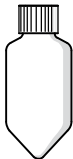
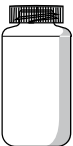
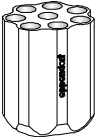
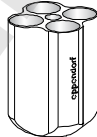
| Description | Order no. |
|---|--------------|
| Rotor S-4-72* ³ , incl. 4 x 250 mL round buckets | 5804 746.007 |







| | | | | |
|---|---|---|---|---|
|  |  |  |  |  |
| 15 mL conical | 50 mL conical | 50 mL conical skirted | 175-225 conical* ² | 250 mL flat |
| 17 | 31 | 31 | | 62 |
| 120 | 120 | 120 | | 130 |
| - | - | - | | - |
|  |  |  | |  |
| 8/32 conical | 4/16 conical | 2/8 flat | | 1/4 flat |
| 164 | 164 | 153 | | 161 |
| 3,234 | 3,234 | 3,017 | | 3,175 |
| 5804 783.000 | 5804 784.006 | 5804 785.002 | | 5804 787.005 |

Rotor A-4-44

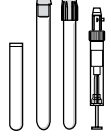
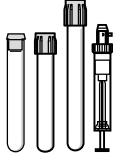
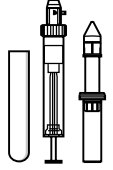
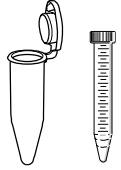
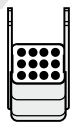
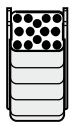

Product features

- > High-speed swing-bucket rotor for applications up to $4,500 \times g$ (5,000 rpm)
- > Rotor A-4-44 accommodates tubes from 0.2 mL to 100 mL
- > Aerosol-tight caps*¹ for safe centrifugation of hazardous samples optionally available
- > Rotor life time: max. 34,000 cycles
- > Rotor, buckets, caps, and adapters are autoclavable

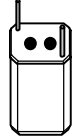
| Tube |  |  |  |  |  |  | |
|--|---|---|---|--|---|---|---|
| Tube capacity (mL) | 1.5/2 | 1.2-5 | 1.8-7 | 4-10 | 7-17 | Eppendorf Tubes® 5.0 mL and 15 mL conical | |
| Max. tube diameter (Ø mm) | 11 | 11 | 13 | 16 | 17.5 | 17 | |
| Max. vessel height (mm)*² | 111 | 105 | 108 | 108 | 110 | 121 | |
| Max. vessel height for use with aerosol-tight lid*¹ (mm) | 105 | 102 | 106 | 106 | 106 | - | 121 |
| Adapter/bucket options for Rotor A-4-44 |  |  |  |  |  |  |  |
| Capacity per bucket/rotor | 12/48 | 14/56 | 9/36 | 7/28 | 6/24 | 4/16 | 2/8 |
| Adapter bottom shape | flat | flat with rubber mat | flat with rubber mat | flat with rubber mat | flat with rubber mat | conical | conical |
| Centrifugation radius (cm) | 14.8 | 15.0 | 15.0 | 15.0 | 15.0 | 15.5 | 15.7 |
| Max. RCF (g-force) | 4,100 | 4,200 | 4,200 | 4,200 | 4,200 | 4,300 | 4,400 |
| Order no. (set of 2) | 5804 751.000 | 5804 750.004 | 5804 752.007 | 5804 753.003 | 5804 754.000 | 5804 755.006 | 5804 717.007 |

*¹Aerosol-tightness tested by Public Health England, Porton Down, UK.

*²Exceeding the maximum tube length may reduce the loading capacity of the rotor. Please perform a manual swing-out test before starting the centrifuge run to make sure the tubes do not hit the rotor yoke.

*³For high g-forces we recommend using centrifuge tubes of Duran® glass.

*⁴Reordering of 50 mL form inserts: 5804 728.009.











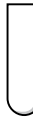
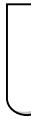

*⁵Max. load per bucket: 140 grams.

*⁶Set of 4.

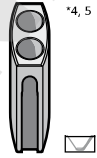
*⁷Form inserts for 50 mL conical tubes skirted need to be ordered separately. Order no. 5804 737.008 (set of 8).

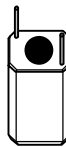
Ordering information

| Description | Order no. |
|---|--------------|
| Rotor A-4-44 | |
| Rotor A-4-44, incl. 4 × 100 mL rectangular buckets | 5804 709.004 |
| Rotor A-4-44, incl. four 2 × 50 mL buckets | 5804 719.000 |
| Buckets for Rotor A-4-44 | |
| Bucket, 100 mL rectangular, set of 4 | 5804 741.005 |
| Bucket, 2 × 50 mL, set of 4 | 5804 706.005 |
| Accessories | |
| Aerosol-tight cap*1 for 100 mL rectangular bucket, set of 2 | 5804 712.005 |

| | | | | | | | | |
|---|---|---|---|---|---|---|---|-----|
|  |  |  |  |  |  |  | | |
| *3 | *3 | | | *3 | *3 | *3 | | |
| 7-18 | 18-30 | 50 mL conical | 50 mL conical, skirted | 30-50 | 50-75 | 80-100 | | |
| 20 | 26 | 31 | 31 | 31 | 35 | 45 | | |
| 107 | 110 | 122 | 122 | 122 | 119 | 114 | | |
| 104 | 100 | - | - | 119 | - | 108 | 108 | 100 |
|  |  |  |  |  |  |  |  | |
| 4/16 | 2/8 | 2/8 | 1/4 | 1/4 | 5804 737.008 | 1/4 | 1/4 | 1/4 |
| flat with rubber mat | flat with rubber mat | flat w/conical form insert*6 | conical | conical | flat with rubber mat | flat with rubber mat | flat with rubber mat | |
| 15.0 | 15.0 | 16.1 | 15.5 | 15.7 | 15.0 | 15.0 | 15.0 | |
| 4,200 | 4,200 | 4,500 | 4,300 | 4,400 | 4,200 | 4,200 | 4,200 | |
| 5804 756.002 | 5804 757.009 | 5804 706.005*6 | 5804 758.005 | 5804 718.003 | 5804 759.001 | 5804 760.000 | 5804 761.006 | |

Rotor A-2-DWP-AT and A-2-DWP



Aerosol-tight*¹ deepwell plate Rotor A-2-DWP-AT*²

- > For use in Centrifuge 5810/5810 R only
- > Max. speed: 3,486 × g (4,500 rpm)
- > Rotor can handle up to
 - 2 × 6 MTP
 - 2 × 2 DWP
 - 2 × 1 Filtration plate kits
- > Maximum loading height of 67 mm (89 mm without lid)
- > Rotor comes with aerosol-tight caps*¹ for safe centrifugation of hazardous samples
- > Rotor and buckets are autoclavable

Deepwell plate Rotor A-2-DWP

- > For use in Centrifuge 5804/5804 R and 5810/5810 R
- > Max. speed: 2,250 × g (3,700 rpm)
- > Rotor can handle up to
 - 2 × 5 MTP
 - 2 × 4 Cell culture plates
 - 2 × 2 DWP
 - 2 × 1 Filtration plate kits
- > Maximum loading height of 89 mm
- > Rotor and buckets are autoclavable

Ordering information

| Description | Order no. |
|---|--------------|
| Aerosol-tight deepwell plate Rotor A-2-DWP-AT*² | |
| Rotor A-2-DWP-AT, incl. buckets, aerosol-tight caps and plate carrier | 5820 710.004 |
| Deepwell plate Rotor A-2-DWP | |
| Rotor A-2-DWP, incl. 2 deepwell plate buckets | 5804 740.009 |

*¹ Aerosol-tightness is tested and certified by Public Health England, Porton Down, UK.

*² Please note that a software upgrade may be necessary for older centrifuges when using Rotor A-2-DWP-AT. Please contact your local Eppendorf organization or dealer for further information.

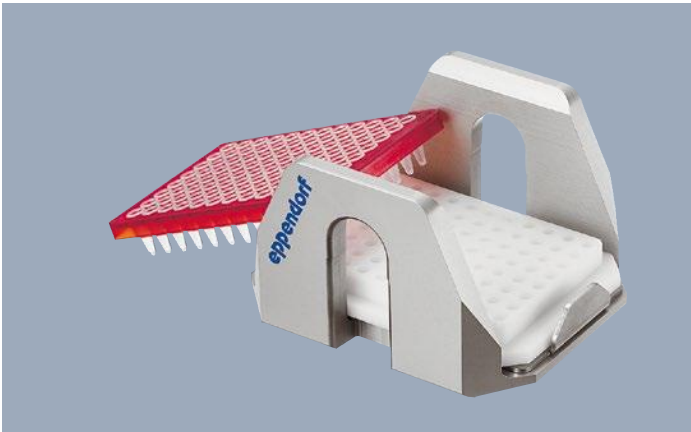

PCR plate adapter (PCR 96)

- > PCR plate adapters are designed to support thin-walled PCR plate wells during centrifugation
- > Available for 96-well and 384-well PCR plates
- > Adapters can be used in all Eppendorf plate rotors

IsoRack adapter

- > IsoRack adapters to support 0.5 mL and 1.5/2 mL IsoRacks during centrifugation
- > Adapters can be used in Eppendorf plate rotors A-2-DWP, A-4-81-MTP/Flex and S-4-104



Cell culture flask adapter

- > Adapter to spin down cell cultures directly in a cell culture flask
- > Suitable for 25 cm² flasks
- > Adapters can be used with Rotor A-4-81-MTP/Flex

CombiSlide adapter

- > Designed for drying slides after hybridization experiments
- > Adapter can hold up to 12 regular glass slides
- > Removable inserts allow centrifugation of glass slides across and parallel to the direction of rotation
- > Adapters can be used in all Eppendorf plate rotors

Ordering information

| Description | Order no. |
|--|--------------|
| Adapter PCR 96-well plate, set of 2 | 5825 711.009 |
| Adapter PCR 384-well plate, set of 2 | 5825 713.001 |
| Adapter, for cell culture flasks, set of 2 | 5825 719.000 |
| Adapter, for IsoRack 24 × 0.5 mL tubes, set of 2 | 5825 708.008 |
| Adapter, for IsoRack 24 × 1.5/2 mL tubes, set of 2 | 5825 709.004 |
| CombiSlide® adapter, for up to 12 glass slides, set of 2 | 5825 706.005 |











Rotor F-34-6-38

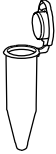

Product features

- > High-speed rotor for molecular biology applications in tubes from 0.2 mL to 85 mL
- > Max. speed 18,500 × g (12,000 rpm) in Centrifuge 5810 R or 15,500 × g (11,000 rpm) in 5804/5804R/5810*¹
- > Low rotor weight (3.2 kg) for easy handling
- > 34° borehole angle reduces pellet smears along tube wall
- > Anodized aluminum for high chemical resistance
- > Rotor, lid, and adapters are autoclavable





*¹ Rotors F-34-6-38 and FA-45-6-30 maintain 4°C at 11,000 rpm.





| Tube |  |  |  |  |  |
|--|---|---|--|---|---|
| Common volumes (mL) | 1.5/2 | 2–5 13 × 75 mm | 4–7 13 × 100 mm | 4–10 | Eppendorf Tubes® 5.0 mL |
| Max. tube diameter (Ø mm) | 11 | 13 | 13 | 16 | 17 |
| Max. tube height for use lid (mm) | 110 | 90 | 110 | 112 | 104 |
| Adapter options for Rotor F-34-6-38 |  |  |  |  |  |
| Capacity per adapter/rotor | 4/24 | 3/18 | 3/18 | 2/12 | 1/6 |
| Adapter bottom shape | round | flat | flat | round | conical |
| Centrifugation radius (cm) | 11.3 | 10.6 | 11.4 | 11.2 | 10.5 |
| RCF (g-force) at at 12,100 rpm (5810 R) | 18,200 | 17,070 | 18,350 | 18,000 | 16,824 |
| at 11,000 rpm (5804/5804 R/5810) | 15,300 | 14,340 | 15,420 | 15,150 | 14,150 |
| Order no. (set of 2) | 5804 770.005 | 5804 738.004 | 5804 739.000 | 5804 771.001 | 5804 777.000 |

*² Nominal tube volume as published by the tube manufacturer.

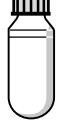
Ordering information

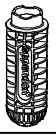
| Description | Order no. |
|---|--------------|
| Rotor F-34-6-38 for 6 × 85 mL tubes incl. rotor lid | 5804 727.002 |

| | | | | | |
|---|---|---|---|---|---|
|  |  |  |  |  |  |
| 15 mL conical | 15-18 | 20-30 | 50 | 50 mL conical | 85*2 |
| 17 | 18 | 26 | 29 | 29 | 38 |
| 123 | 123 | 123 | 123 | 121 | 121 |

| | | | | | |
|---|---|---|---|---|-------------------|
|  |  |  |  |  | no adapter needed |
| 1/6 conical | 1/6 round | 1/6 round | 1/6 round | 1/6 conical | 1/6 round |
| 10.7 | 10.9 | 11.0 | 11.2 | 10.8 | 11.5 |
| 17,200 14,450 | 17,550 14,750 | 17,700 14,900 | 18,000 15,150 | 17,400 14,600 | 18,500 15,500 |
| 5804 776.003 | 5804 772.008 | 5804 773.004 | 5804 774.000 | 5804 775.007 | - |

Rotor FA-45-6-30









Product features

- > High-speed rotor for applications in tubes from 5–50 mL
- > Max. speed 20,130 × g (12,100 rpm) in Centrifuge 5810 R or 16,639 × g (11,000 rpm) in 5804/5804R/5810*1
- > Eppendorf QuickLock rotor lid for fast lid locking
- > Aerosol-tight*2 for safe centrifugation of hazardous samples
- > Low rotor weight (3.2 kg) for easy lifting
- > Anodized aluminum for high chemical resistance
- > 45° borehole angle minimizes pellets smear
- > Rotor, lid, and adapters are autoclavable

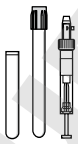
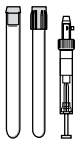
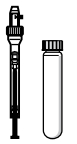
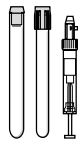
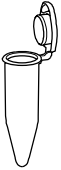
*1 Rotors F-34-6-38 and FA-45-6-30 maintain 4°C at 11,000 rpm.
 *2 Aerosol-tightness tested by Public Health England, Porton Down, UK.

Ordering information

| Description | Order no. |
|--|--------------|
| Rotor FA-45-6-30*3, incl. aerosol-tight Eppendorf QuickLock® lid | 5820 715.006 |

| Tube |  |  |  |  |  |
|---|---|---|--|---|---|
| Common volumes (mL) | 2.6–5 13 × 75 mm | 4–8 13 × 100 mm | 5.5–10 16 × 75 mm | 7.5–12 16 × 100 mm | Eppendorf Tubes® 5.0 mL |
| Max. tube diameter (Ø mm) | 13 | 13 | 16 | 16 | 17 |
| Max. tube height for use with aerosol-tight lid*1 (mm) | 119 | 119 | 119 | 119 | 121 |
| Adapter options for Rotor FA-45-6-30 |  |  |  |  |  |
| Capacity per adapter/rotor | 1/6 | 1/6 | 1/6 | 1/6 | 1/6 |
| Adapter bottom shape | round | round | round | round | conical |
| Centrifugation radius (cm) | 12.0 | 12.0 | 12.0 | 12.0 | 12.1 |
| RCF (g-force) at at 12,100 rpm (5810 R) at 11,000 rpm (5804/5804 R/5810) | 19,246 16,233 | 19,246 16,233 | 19,246 16,233 | 19,246 16,233 | 19,806 16,369 |
| Order no. (set of 2) | 5820 726.008 | 5820 725.001 | 5820 728.000 | 5820 727.004 | 5820 730.005 |









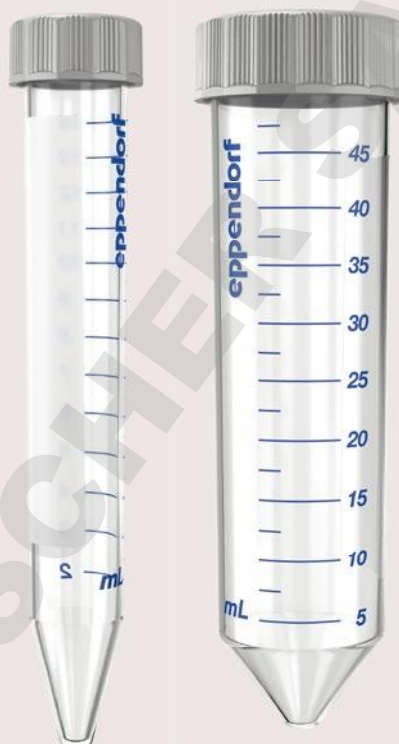

*3 Please note that a software upgrade may be necessary for older centrifuges when using Rotor FA-45-6-30.
 Please contact your local Eppendorf organization or dealer for further information.

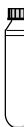
Eppendorf Conical Tubes

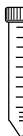
Whether centrifugation, mixing, or other applications – the Eppendorf Conical Tubes 15 mL and 50 mL will perfectly fit into your workflows. They represent the next step in Eppendorf’s comprehensive system solutions in liquid, sample, and cell handling.

More information: www.eppendorf.com/conicals



| | | | | | |
|---|---|---|---|---|---|
|  |  |  |  |  |  |
| 7-17 | 15 mL conical | 15-18 | 20-30 | 35 | 50 mL conical |
| 17.5 | 17 | 18 | 26 | 29 | 31 |
| 122 | 125 | 125 | 125 | 125 | 121 |
|  |  |  |  |  | no adapter needed |
| 1/6 round | 1/6 conical | 1/6 round | 1/6 round | 1/6 conical | 1/6 conical |
| 12.0 | 12.0 | 12.0 | 10.5 | 11.2 | 12.3 |
| 19,246 16,233 | 19,246 16,223 | 19,246 16,223 | 17,187 14,204 | 18,333 16,161 | 20,130 16,639 |
| 5820 729.007 | 5820 717.009 | 5820 720.000 | 5820 721.006 | 5820 722.002 | – |

Rotor F-35-48-17 and FA-45-20-17



Rotor F-35-48-17*1

- > High-capacity fixed-angle rotor for 15 mL conical and glass tubes
- > Max. speed: 5,005 × g (5,500 rpm)
- > Form inserts for 15 mL conical tubes



Rotor FA-45-20-17*1

- > 20 places for Eppendorf Tubes® 5.0 mL
- > Max. speed: 20,913 × g (13,100 rpm)
- > Eppendorf QuickLock rotor lid for fast lid locking
- > Rotor, lid and adapters are autoclavable
- > Anodized aluminum for high chemical resistance

Ordering information

| Description | Order no. |
|---|--------------|
| Fixed-angle Rotor F-35-48-17 | |
| Includes 48 steel sleeves for 15 mL tubes, with 40 conical inserts and 48 rubber mats | 5820 772.000 |
| Includes 24 steel sleeves for 15 mL tubes, with 24 conical inserts and 24 rubber mats | 5820 771.003 |
| Fixed-angle rotor FA-45-20-17 | |
| Rotor FA-45-20-17, 20 × 5.0 mL, incl. aerosol-tight Eppendorf QuickLock® rotor lid | 5820 765.003 |
| Adapter for 1.5/2.0 mL tubes, set of 4 | 5820 768.002 |
| Adapter for cryogenic vials, set of 4 | 5820 769.009 |
| Adapter for HPLC tubes, set of 4 | 5820 770.007 |

*1 Please note that a software upgrade will be necessary for older centrifuges when using Rotor F-35-48-17 or FA-45-20-17. Please contact your local Eppendorf organization or dealer for further information.



Rotors F-45-30-11 and FA-45-30-11

- > 30 places for 1.5/2.0 mL tubes
- > Max. speed: 20,800 × g (14,000 rpm)
- > Rotor FA-45-30-11 comes with aerosol-tight*2 lid for safe centrifugation of hazardous samples
- > Rotors and lids are autoclavable

Rotor FA-45-48-11*3

- > 48 places for 1.5/2.0 mL tubes
- > Max. speed: 19,083 × g (max. 13,000 rpm)
- > Eppendorf QuickLock rotor lid for fast lid locking
- > Aerosol-tight*2 for safe centrifugation of hazardous samples
- > Anodized aluminum for high chemical resistance
- > Rotor and lid are autoclavable



Drum Rotor T-60-11

- > High capacity for 60 × 1.5/2.0 mL tubes
- > Max. speed: 16,400 × g (14,000 rpm)
- > Horizontal centrifugation for pellet formation at tube bottom—ideal for low sample quantities

Rotor F-45-48-PCR

- > Accommodates up to 6 × 5/8-tube PCR strips or 48 × 0.2 mL PCR tubes
- > Safe and easy handling without additional lid
- > Max. speed: 15,350 × g (12,000 rpm)



Ordering information

| Description | Order no. |
|--|--------------|
| Rotor FA-45-48-11, incl. aerosol-tight Eppendorf QuickLock® rotor lid | 5820 760.001 |
| Rotor FA-45-30-11, 30 × 1.5/2.0 mL, with aluminum lid, aerosol-tight*1 | 5804 726.006 |
| Rotor F-45-30-11, 30 × 1.5/2.0 mL, with aluminum lid | 5804 715.004 |
| Adapter for 0.2 mL PCR tubes (for 1.5/2 mL rotors), set of 6 | 5425 715.005 |
| Adapter for 0.4 mL tubes (for 1.5/2 mL rotors), set of 6 | 5425 717.008 |
| Adapter for 0.5 mL tubes (for 1.5/2 mL rotors), set of 6 | 5425 716.001 |
| Adapter for BD Microtainer® (for 1.5/2 mL rotors), set of 6 | 5425 716.001 |
| Drum rotor T-60-11, with lid, without adapters | 5804 730.003 |
| Adapter for 10 × 1.5/2 mL tubes (Ø 11 mm), set of 6 | 5804 731.000 |
| Adapter for 20 × 0.4 mL tubes (Ø 6 mm), set of 6 | 5804 732.006 |
| Rotor F-45-48-PCR, for 6 × 8-tube PCR strips | 5804 735.005 |

*2 Aerosol-tightness is tested and certified by Public Health England, Porton Down, UK.

** Please note that a software upgrade will be necessary for older centrifuges when using Rotor FA-45-48-11. Please contact your local Eppendorf organization or dealer for further information.

Rolling Cabinet



If space is a limited resource in your lab, Eppendorf's rolling cabinet can give you the freedom and flexibility to use your Centrifuge 5804/5804 R or 5810/5810 R wherever you need it. Use the rolling cabinet if there is not enough space on the regular lab bench or to transport and use the centrifuge in other labs.

The included drawer provides extra storage space for your rotors and adapters.

- > Rolling cabinet with closed centrifuge fits under standard 90 cm lab benches
- > With 4 castors (2 lockable) and drawer
- > Dimensions: W x D x H: 70 x 62 x 45 cm



Watch video!

Ordering information

| Description | Order no. |
|---|--------------|
| Rolling cabinet, for Centrifuge 5804/5804 R and 5810/5810 R | 5821 020.010 |

Centrifuge 5804/5804 R and 5810/5810 R

Technical specifications

| Description | Centrifuge 5804 | Centrifuge 5804 R | Centrifuge 5810 | Centrifuge 5810 R |
|----------------------------------|--|-------------------|-----------------|-------------------|
| Max. rcf | | | | |
| > Fixed-angle rotor | 20,913 × g | 20,913 × g | 20,913 × g | 20,913 × g |
| > Swing-bucket rotor | 4,500 × g | 4,500 × g | 4,500 × g | 4,500 × g |
| > Plate rotor | 2,250 × g | 2,250 × g | 3,486 × g | 3,486 × g |
| Speed | 200–14,000 rpm (in 10 rpm increments) | | | |
| Max. capacity | 4 × 250 mL | 4 × 250 mL | 4 × 750 mL | 4 × 750 mL |
| Rotor options | 12 | 12 | 18 | 18 |
| Accel./Braking ramps | 10/10 | | | |
| Programs | 35 user programs | | | |
| Timer | 1 min. to 99 min, with continuous mode, short spin | | | |
| Temperature control range | N/A | –9 °C to 40 °C | N/A | –9 °C to 40 °C |
| Noise level | | | | |
| > Rotor S-4-104 (4 × 750 mL) | | | <70 dB(A) | <56 dB(A) |
| > Rotor S-4-72 (4 × 250 mL) | <62 dB(A) | <58 dB(A) | | |
| > Rotor FA-45-6-30 (6 × 50 mL) | <55 dB(A) | <54 dB(A) | <56 dB(A) | <55 dB(A) |
| Power supply | 230 V/50–60 Hz | | | |
| Power requirement | Max. 900 W | Max. 1,650 W | Max. 900 W | Max. 1,650 W |
| Dimensions (W × D × H) | 47 × 55 × 34 cm | 64 × 55 × 34 cm | 54 × 61 × 35 cm | 70 × 61 × 35 cm |
| Access height | 28 cm | 28 cm | 28 cm | 28 cm |
| Height with open lid | 74 cm | 74 cm | 80 cm | 80 cm |
| Weight without rotor | 55 kg | 80 kg | 68 kg | 99 kg |

Centrifuge Packages



Ordering information

Cell culture centrifuge packages*

| | Max. capacity of conical tubes per rotor | Order no. |
|--|--|--------------|
| Centrifuge 5804, with Rotor A-4-44 incl. adapters for 15 mL/50 mL conical tubes | 16 × 15 mL / 4 × 50 mL | 5804 000.320 |
| Centrifuge 5804 R, refrigerated, with Rotor A-4-44 incl. adapters for 15 mL/50 mL conical tubes | 16 × 15 mL / 4 × 50 mL | 5805 000.320 |
| Centrifuge 5804, with Rotor S-4-72 incl. adapters for 15 mL/50 mL conical tubes | 32 × 15 mL / 16 × 50 mL | 5804 000.520 |
| Centrifuge 5804 R, refrigerated, with Rotor S-4-72 incl. adapters for 15 mL/50 mL conical tubes | 32 × 15 mL / 16 × 50 mL | 5805 000.620 |
| Centrifuge 5810, with Rotor A-4-62 incl. adapters for 15 mL/50 mL conical tubes | 36 × 15 mL / 16 × 50 mL | 5810 000.320 |
| Centrifuge 5810 R, refrigerated, with Rotor A-4-62 incl. adapters for 15 mL/50 mL conical tubes | 36 × 15 mL / 16 × 50 mL | 5811 000.325 |
| Centrifuge 5810, with Rotor A-4-81 incl. adapters for 15 mL/50 mL conical tubes | 48 × 15 mL / 20 × 50 mL | 5810 000.420 |
| Centrifuge 5810 R, refrigerated, with Rotor A-4-81 incl. adapters for 15 mL/50 mL conical tubes | 48 × 15 mL / 20 × 50 mL | 5811 000.420 |
| Centrifuge 5810, with Rotor S-4-104 incl. adapters for 15 mL/50 mL conical tubes | 56 × 15 mL / 28 × 50 mL | 5810 000.525 |
| Centrifuge 5810 R, refrigerated, with Rotor S-4-104 incl. adapters for 15 mL/50 mL conical tubes | 56 × 15 mL / 28 × 50 mL | 5811 000.620 |

Centrifuge packages for round-bottom tubes

| | Max. capacity of round-bottom tubes per rotor | Order no. |
|--|---|--------------|
| Centrifuge 5810, with Rotor S-4-104 incl. adapters for round-bottom tubes with diameter 13/16 mm | 92 × 13 mm / 80 × 16 mm | 5810 000.620 |
| Centrifuge 5810 R, refrigerated, with Rotor S-4-104 incl. adapters for round-bottom tubes with diameter 13/16 mm | 92 × 13 mm / 80 × 16 mm | 5811 000.820 |

*230 V/50–60 Hz

Technical specifications subject to change. Errors and omissions excepted.

Centrifuge Family Overview

Eppendorf Microcentrifuges



| | MiniSpin® | MiniSpin® plus | 5418 R | 5424 R | 5427 R | 5430 | 5430 R |
|-------------------------|---------------|----------------|-----------------|-------------------------|-----------------|--|-----------------|
| Model | Entry-level | | Medium capacity | The laboratory standard | High throughput | Microcentrifuge with multipurpose capabilities | |
| Max. Capacity | 12 × 1.5/2 mL | | 18 × 1.5/2 mL | 24 × 1.5/2 mL | 48 × 1.5/2 mL | 48 × 1.5/2 mL (6 × 15/50 mL, 2 × MTP) | |
| Max. speed (RCF) | 12,100 × g | 14,100 × g | 16,873 × g | 21,130 × g | 25,000 × g | 30,130 × g | |
| Max. rpm | 13,400 | 14,500 | 14,000 | 15,000 | 16,220 | 17,500 | |
| Rotor options | 2 | | 1 | 4 | 9 | 12 | |
| Refrigerated | – | – | 0 °C to 40 °C | –10 °C to 40 °C | –10 °C to 40 °C | – | –11 °C to 40 °C |
| Ordering no. | 5452 000.010 | 5453 000.015 | 5401 000.010 | 5404 000.610 | 5409 000.010 | 5427 000.610 | 5428 000.610 |

Eppendorf Multipurpose Centrifuges



| | 5702 | 5702 R | 5702 RH | 5804 | 5804 R | 5810 | 5810 R | 5910 R | 5920 R |
|------------------------------------|--|----------------|--|--|----------------|--|----------------|-----------------------------------|---|
| Model | Low speed centrifuge for medium capacity needs | | Active heating and cooling for high temperature accuracy | Compact high speed centrifuge for medium capacity needs. With swing-bucket rotor and deepwell plate capacity | | The workhorse for medium to high-throughput laboratories: Highly versatile, high speed and high plate capacity | | High throughput, high performance | Bench-top centrifuge with floor-standing capabilities |
| Capacity | 4 × 100 mL | | | 4 × 250 mL | | 4 × 750 mL | | 4 × 750 mL | 4 × 1,000 mL |
| > Conical tubes | 20 × 15 mL/4 × 50 mL | | | 40 × 15 mL/16 × 50 mL | | 56 × 15 mL/28 × 50 mL | | 64 × 15 mL/ 36 × 50 mL | 108 × 15 mL/ 52 × 50 mL |
| > Blood collection tubes | 36 × 13 mm/30 × 16 mm | | | 56 × 13 mm/52 × 16 mm | | 100 × 13 mm/80 × 16 mm | | 120 × 13 mm/ 104 × 16 mm | 196 × 13 mm/ 148 × 16 mm |
| > Plates | – | | | 10 × MTP/2 × DWP | | 16 × MTP/4 × DWP | | 20 × MTP/ 4 × DWP | 28 × MTP/ 8 × DWP |
| Max. speed (RCF) | 3,000 × g | | | 20,913 × g | | 20,913 × g | | 22,132 × g | 21,194 × g |
| Max. rpm | 4,400 | | | 14,000 | | 14,000 | | 14,000 | 13,700 |
| Rotor options | 6 | | | 12 | | 18 | | – | – |
| Refrigerated | – | –9 °C to 40 °C | –9 °C to 42 °C | – | –9 °C to 40 °C | – | –9 °C to 40 °C | –11 °C to 40 °C | –11 °C to 40 °C |
| Ordering no. | 5702 000.010 | 5703 000.010 | 5704 000.010 | 5804 000.010 | 5805 000.010 | 5810 000.010 | 5811 000.015 | 5942 000.010 | 5948 000.010 |

Technical specifications subject to change. Errors and omissions excepted.

Your local distributor: www.eppendorf.com/contact
 Eppendorf AG 22339 · Hamburg · Germany
 E-mail: eppendorf@eppendorf.com · www.eppendorf.com

www.eppendorf.com/centrifugation