

Register your instrument!
www.eppendorf.com/myeppendorf



Centrifuge 5920 R

Operating manual

Copyright © 2015 Eppendorf AG, Germany. All rights reserved, including graphics and images. No part of this publication may be reproduced without the prior permission of the copyright owner.



Corning® is a registered trademark of Corning Inc., USA.

Microtainer® and Vacutainer® are registered trademarks of Becton Dickinson, USA.

Nalgene® is a registered trademark of Nalge Nunc International Corporation, USA.

TaqMan® is a registered trademark of Roche Molecular Systems, Inc., USA

Eppendorf® and the Eppendorf logo are registered trademarks of Eppendorf AG, Germany.

Eppendorf QuickLock® and FastTemp pro® are registered trademarks of Eppendorf AG, Germany.
FastTemp™ is a protected trademark of Eppendorf AG, Germany.

Registered trademarks and protected trademarks are not marked in all cases with ® or ™ in this manual.

U.S. Design Patents are listed on www.eppendorf.com/ip

Table of contents

1	Operating instructions	7
1.1	Using this manual	7
1.2	Danger symbols and danger levels	7
1.2.1	Danger symbols	7
1.2.2	Danger levels	7
1.3	Symbols used	7
1.4	Abbreviations used	8
2	Safety	9
2.1	Intended use	9
2.2	User profile	9
2.3	Information on product liability	9
2.4	Application limits	10
2.4.1	Declaration concerning the ATEX directive (94/9/EC)	10
2.5	Warnings for intended use	10
2.5.1	Personal injury or damage to the equipment	10
2.5.2	Incorrect handling of the centrifuge	12
2.5.3	Incorrect handling of the rotors	12
2.5.4	Extreme strain on the centrifuging tubes	14
2.6	Safety instructions on the device	14
3	Product description	15
3.1	Product overview	15
3.2	Delivery package	16
3.3	Features	16
4	Installation	17
4.1	Selecting the location	17
4.2	Preparing installation	18
4.3	Installing the instrument	18
5	Operation	19
5.1	Operating controls	19
5.2	Switching on the centrifuge	20
5.3	Initial steps	21
5.3.1	Setting the menu language	21
5.3.2	Setting date and time	21
5.4	Replacing the rotor	22
5.4.1	Inserting the rotor	22
5.4.2	Removing the rotor	22
5.4.3	Triggering rotor detection	23
5.5	Loading a fixed-angle rotor	24
5.5.1	Closing the rotor lid	24
5.5.2	Closing the QuickLock rotor lid	25

Table of contentsCentrifuge 5920 R
English (EN)

5.6	Loading the swing-bucket rotor	26
5.6.1	Inserting the bucket in the swing-bucket rotor.	26
5.6.2	Performing an imbalance calibration	26
5.6.3	Loading the buckets symmetrically.	27
5.6.4	Closing the bucket with the cap	30
5.6.5	Mixed loading with buckets and plate carriers.	30
5.7	Closing the centrifuge lid	31
5.8	Aerosol-tight centrifugation	32
5.8.1	Aerosol-tight centrifugation in a fixed-angle rotor.	32
5.8.2	Aerosol-tight centrifugation in a swing-bucket rotor	32
5.9	Centrifuging	33
5.9.1	Centrifugation with time setting	33
5.9.2	End of centrifugation	34
5.9.3	Centrifuging in continuous operation.	34
5.9.4	Short spin centrifugation	35
5.9.5	Setting the radius	35
5.9.6	Setting the acceleration ramp and braking ramp	36
5.9.7	Setting the beginning of time counting (At set rpm function)	36
5.10	Cooling	36
5.10.1	Set temperature.	36
5.10.2	Temperature display	37
5.10.3	Temperature monitoring	37
5.10.4	Temperature control run FastTemp.	37
5.10.5	FastTemp pro: Automatic temperature control run with programmed start time	38
5.10.6	Continuous cooling	39
5.10.7	Endless operation of continuous cooling	39
5.11	Switching off the centrifuge	40
6	Device settings	41
6.1	Standby mode	41
6.1.1	Switching on the standby mode	41
6.2	Key lock.	41
6.3	Display.	42
6.3.1	Showing the set value row	42
6.3.2	Setting the contrast.	42
6.4	Speaker	42
6.4.1	Switching the loudspeaker on/off	42
6.4.2	Setting the volume	42
6.5	Calling up device information	42
6.6	Cycle counter	43
6.6.1	Notes on reaching the maximum number of cycles.	43
6.6.2	Resetting the number of cycles.	44
6.6.3	Changing the number of cycles	44

7	Programs	45
7.1	Saving the program.....	45
7.1.1	Creating a program.....	45
7.1.2	Quick save with program keys.....	46
7.2	Loading a saved program.....	47
7.2.1	Loading program prog 1 to prog 5.....	47
7.2.2	Loading a program from the program list.....	47
7.2.3	Editing programs.....	48
7.3	Deleting a program.....	48
8	Maintenance	49
8.1	Maintenance.....	49
8.2	Prepare cleaning/disinfection.....	49
8.3	Cleaning/disinfection.....	50
8.3.1	Cleaning and disinfecting the device.....	51
8.3.2	Cleaning and disinfecting the rotor.....	51
8.3.3	Changing the seal of the aerosol-tight cap.....	52
8.4	Additional care instructions for refrigerated centrifuges.....	53
8.5	Cleaning glass breakage.....	53
8.6	Resetting the excess current switch.....	54
8.7	Decontamination before shipment.....	54
9	Troubleshooting	55
9.1	General errors.....	55
9.2	Error messages.....	56
9.3	Emergency release.....	58
10	Transport, storage and disposal	59
10.1	Transport.....	59
10.2	Storage.....	59
10.3	Disposal.....	59
11	Technical data	61
11.1	Power supply.....	61
11.2	Weight/dimensions.....	61
11.3	Noise level.....	61
11.4	Ambient conditions.....	61
11.5	Application parameters.....	62
11.6	Acceleration and deceleration times.....	63
11.7	Service life for accessories.....	64

Table of contentsCentrifuge 5920 R
English (EN)

12 Rotors for Centrifuge 5920 R	67
12.1 Rotor S-4×1000	67
12.1.1 Swing-bucket rotor S-4×1000 with 4 aerosol-tight round buckets 1000 mL	67
12.1.2 Swing-bucket rotor S-4×1000 with 4 High-Capacity Buckets	71
12.1.3 Swing-bucket rotor S-4×1000 with 4 aerosol-tight plates/tube buckets	75
12.2 Rotor S-4 ×750	79
12.2.1 Swing-bucket rotor S-4×750 with 4 aerosol-tight round buckets 750 mL	79
12.2.2 Swing-bucket rotor S-4×750 with 4 plate buckets	82
12.3 Rotor F-6×85	84
12.4 Rotor FA-6×50	86
12.5 Rotor FA-20×5	88
12.6 Rotor FA-48×2	89
13 Ordering information	91
13.1 Centrifuge 5920 R	91
13.2 Rotors and accessories	91
13.2.1 Rotor S-4×1000	91
13.2.2 Rotor S-4×750	92
13.2.3 Rotor F-6×85	93
13.2.4 Rotor FA-6×50	93
13.2.5 Rotor FA-20×5	93
13.2.6 Rotor FA-48×2	94
13.3 Accessories	94
Index	95
Certificates	97

1 Operating instructions







1.1 Using this manual

- ▶ Read this operating manual completely before using the device for the first time. Also observe the instructions for use of the accessories.
- ▶ This operating manual is part of the product. Thus, it must always be easily accessible.
- ▶ Enclose this operating manual when transferring the device to third parties.
- ▶ You will find the current version of the operating manual for all available languages on our website under www.eppendorf.com/manuals.

1.2 Danger symbols and danger levels

1.2.1 Danger symbols


The safety instructions in this manual appear with the following danger symbols and danger levels:

	Biohazard		Explosive substances
	Electric shock		Risk of crushing
	Hazard point		Material damage

1.2.2 Danger levels

DANGER	<i>Will</i> lead to severe injuries or death.
WARNING	<i>May</i> lead to severe injuries or death.
CAUTION	May lead to light to moderate injuries.
NOTICE	May lead to material damage.

1.3 Symbols used

Depiction	Meaning
1. 2.	Actions in the specified order
▶	Actions without a specified order
•	List
<i>Text</i>	Display text or software text
	Additional information

1.4 Abbreviations used

MTP

Microplate

PCR

Polymerase chain reaction

PTFE

Polytetrafluorethylene

rcfRelative centrifugal force – Relative centrifugal force g force in m/s^2 **rpm**

Revolutions per minute – Revolutions per minute

UV

Ultraviolet radiation

2 Safety

2.1 Intended use

The Centrifuge 5920 R is designed for separating substance mixtures with different densities, in particular, for processing and analyzing samples from the human body in in vitro diagnostic applications to ensure that the in vitro diagnostic device can be used according to its intended purpose.

Therefore, this centrifuge is an in vitro diagnostic device according to Directive 98/79/EC of the European Parliament and the Council dated October 27, 1998.

This device may not be used near sources of strong electromagnetic radiation (e.g., unshielded high-frequency sources) because they can interfere with proper operation.

For devices with class A noise emission according to EN 61326-1 (see the Technical Data chapter in the device operating manual), this device was developed and tested according to CISPR 11 Class A. It can cause radio interference in domestic environments. If this occurs, you may need to execute measures to eliminate the faults.

Eppendorf centrifuges are exclusively intended for indoor use by trained specialists. All country-specific safety requirements for operating electrical equipment in the laboratory must be observed.

2.2 User profile

The device and accessories may only be operated by trained and skilled personnel.

Before using the device, read the operating manual carefully and familiarize yourself with the device's mode of operation.

2.3 Information on product liability

In the following cases, the designated protection of the device may be compromised. Liability for any resulting property damage or personal injury is then transferred to the operator:

- The device is not used in accordance with the operating manual.
- The device is used outside of its intended use.
- The device is used with accessories or consumables which are not recommended by Eppendorf.
- The device is maintained or repaired by people not authorized by Eppendorf.
- The user makes unauthorized changes to the device.

2.4 Application limits

2.4.1 Declaration concerning the ATEX directive (94/9/EC)

**DANGER! Risk of explosion.**

- ▶ Do not operate the device in areas where work is completed with explosive substances.
- ▶ Do not use this device to process any explosive or highly reactive substances.
- ▶ Do not use this device to process any substances which could create an explosive atmosphere.

Due to its design and the environmental conditions inside the device, the Centrifuge 5920 R is not suitable for use in a potentially explosive atmosphere.

The device may only be used in a safe environment, such as in the open environment of a ventilated laboratory or an extractor hood. The use of substances that may contribute to a potentially explosive atmosphere is not permitted. The final decision on risks associated with the use of such substances lies with the user.

2.5 Warnings for intended use

2.5.1 Personal injury or damage to the equipment

**WARNING! Electric shock due to damage to device or mains cable.**

- ▶ Only switch on the device if the device and mains cable are undamaged.
- ▶ Only use devices that have been properly installed or repaired.
- ▶ In case of danger, disconnect the device from the mains supply. Disconnect the mains/power plug from the device or the earth/grounded socket. Use the designated isolating device (e.g., emergency switch in the lab).

**WARNING! Lethal voltages inside the device.**

Touching parts which are under high voltage may cause an electric shock. An electric shock injures the heart and causes respiratory paralysis.

- ▶ Ensure that the housing is closed and undamaged.
- ▶ Do not remove the housing.
- ▶ Ensure that no liquid can penetrate into the device.

Only authorized service staff may open the device.

**WARNING! Risk from incorrect supply voltage**

- ▶ Only connect the device to voltage sources which correspond to the electrical requirements on the name plate.
- ▶ Only use sockets with a protective earth (PE) conductor and suitable power cable.



WARNING! Damage to health due to infectious liquids and pathogenic germs.

- ▶ When handling infectious liquids and pathogenic germs, observe the national regulations, the biological security level of your laboratory, the material safety data sheets, and the manufacturer's application notes.
- ▶ Use aerosol tight sealing systems for the centrifugation of these substances.
- ▶ When working with pathogenic germs belonging to a higher risk group, more than one aerosol-tight bioseal must be used.
- ▶ Wear your personal protective equipment.
- ▶ For comprehensive regulations about handling germs or biological material of risk group II or higher, please refer to the "Laboratory Biosafety Manual" (source: World Health Organization, Laboratory Biosafety Manual, in its respectively current valid version).



WARNING! Risk of injury when opening or closing the centrifuge lid.

There is a risk of crushing your fingers when opening or closing the centrifuge lid.

- ▶ When opening or closing the centrifuge lid, do not reach between the lid and device or into the latching mechanism of the lid.
- ▶ Always open the centrifuge lid completely to prevent it from falling.



WARNING! Risk of injury due to defective gas spring(s).

A defective gas spring is an insufficient support for the centrifuge lid. There is a risk of crushing fingers or limbs.

- ▶ Make sure that the centrifuge lid can be opened completely and that it will remain in this position.
- ▶ Regularly check all gas springs for their proper function.
- ▶ Have defective gas springs replaced immediately.
- ▶ Have gas springs replaced by a service technician every 2 years.



WARNING! Risk of injury from chemically or mechanically damaged accessories.

Even minor scratches and cracks can lead to severe internal material damage.

- ▶ Protect all accessory parts from mechanical damage.
- ▶ Inspect the accessories for damage before each use. Replace any damaged accessories.
- ▶ Do not use any accessories which have exceeded their maximum service life.



CAUTION! Poor safety due to incorrect accessories and spare parts.

The use of accessories and spare parts other than those recommended by Eppendorf may impair the safety, functioning and precision of the device. Eppendorf cannot be held liable or accept any liability for damage resulting from the use of incorrect or non-recommended accessories and spare parts, or from the improper use of such equipment.

- ▶ Only use accessories and original spare parts recommended by Eppendorf.

**NOTICE! Damage to device due to spilled liquids.**

1. Switch off the device.
2. Disconnect the device from the mains/power supply.
3. Carefully clean the device and the accessories in accordance with the cleaning and disinfection instructions in the operating manual.
4. If a different cleaning and disinfecting method is to be used, contact Eppendorf AG to ensure that the intended method will not damage the device.

**NOTICE! Damage to electronic components due to condensation.**

Condensate can form in the device after it has been moved from a cool environment to a warmer environment.

- ▶ After installing the device, wait for at least 4 h. Only then connect the device to the mains/power line.

**NOTICE! Centrifuge 5920 R: Compressor damage after improper transport.**

- ▶ After installation, wait 4 hours before switching on the centrifuge.

2.5.2 Incorrect handling of the centrifuge

**NOTICE! Damage from knocking against or moving the device during operation.**

If the rotor bangs against the rotor chamber wall, it will cause considerable damage to the device and rotor.

- ▶ Do not move or knock against the device during operation.

2.5.3 Incorrect handling of the rotors

**WARNING! Risk of injury from improperly attached rotors and rotor lids.**

- ▶ Only centrifuge with rotor and rotor lid firmly tightened.
- ▶ If there are any unusual noises when the centrifuge is started up, the rotor or rotor lid may not be properly attached. Immediately press the **start/stop** key to stop centrifuging.

**CAUTION! Risk of injury due to asymmetric loading of the rotor.**

- ▶ Load rotors symmetrically with identical tubes or plates and buckets.
- ▶ Always load all positions of a swing-bucket rotor with buckets.
- ▶ Only load adapters with suitable tubes or plates.
- ▶ Always use tubes or plates of the same type (weight, material/density and volume).
- ▶ Check that loading is symmetrical by balancing the adapters and tubes or plates used with scales.



CAUTION! Risk of injury from overloaded rotor.

The centrifuge is designed for the centrifugation of material with a maximum density of 1.2 g/mL at maximum speed and filling volume and/or load.

- ▶ Do not exceed the maximum load of the rotor.



CAUTION! Risk of injury due to chemically damaged rotor lids or caps.

Transparent rotor lids or caps made from PC, PP or PEI may lose their strength under the impact of organic solvents (e.g. phenol, chloroform).

- ▶ If rotor lids or caps have come into contact with organic solvents, they should be cleaned immediately.
- ▶ Check the rotor lids and caps regularly for any damages and cracks.
- ▶ Replace any rotor lids or caps which show cracks or milky stains immediately.



NOTICE! Damage to rotors from aggressive chemicals.

Rotors are high-quality components which withstand extreme stresses. This stability can be impaired by aggressive chemicals.

- ▶ Avoid the use of aggressive chemicals, including strong and weak alkalis, strong acids, solutions with mercury, copper and other heavy metal ions, halogenated hydrocarbons, concentrated saline solutions and phenol.
- ▶ If the rotor is contaminated by aggressive chemicals, clean it immediately using a neutral cleaning agent. Clean the rotor bores in particular.
- ▶ Due to the manufacturing process, color variations may occur on rotors marked "coated". These color variations do not affect the service life or resistance to chemicals.



NOTICE! If handled incorrectly, the rotor may fall.

The swing-bucket rotor may fall if the buckets are used as handles.

- ▶ Remove the buckets before inserting and/or removing a swing-bucket rotor.
- ▶ Always use both hands to carry the rotor cross.



NOTICE! Buckets swinging out in the wrong direction.

If the wrong adapters are used for 500 mL corning vessels, it might happen that the buckets of the swing-bucket rotor swing out in the wrong direction. This can lead to sample loss or damage of the centrifuge.

- ▶ Therefore, only use the Eppendorf adapters for 500 mL corning vessels intended for this purpose.

2.5.4 Extreme strain on the centrifuging tubes



CAUTION! Risk of injury from overloaded tubes.

- ▶ Note the loading limits specified by the tube manufacturer.
- ▶ Only use tubes which are approved by the manufacturer for the required g -force (rcf).



NOTICE! Risk from damaged tubes.

Damaged tubes must not be used, as this could cause further damage to the device and the accessories and loss of the samples.

- ▶ Before use, visually check all of the tubes for damage.



NOTICE! Risk from open tube lids.

Open tube lids can break off during centrifugation and damage both the rotor and the centrifuge.

- ▶ Carefully seal all tube lids before centrifuging.







NOTICE! Hazard to plastic tubes from organic solvents.

The density of plastic tubes is reduced when organic solvents (e.g., phenol, chloroform) are used, i.e. the tubes could become damaged.

- ▶ Note the manufacturer's information on the chemical resistance of the tubes.

2.6 Safety instructions on the device

Symbol	Meaning	Location
	Hazard point	Right side of the device
	Always tighten the rotor with the enclosed rotor key.	Top of device, under the centrifuge lid.
	Risk of crushing	Top of device, under the centrifuge lid.
	Warning of biological risks when handling infectious liquids or pathogenic germs.	Aerosol-tight rotors/rotor lids, aerosol-tight aerosol-tight buckets/caps.

3 Product description

3.1 Product overview

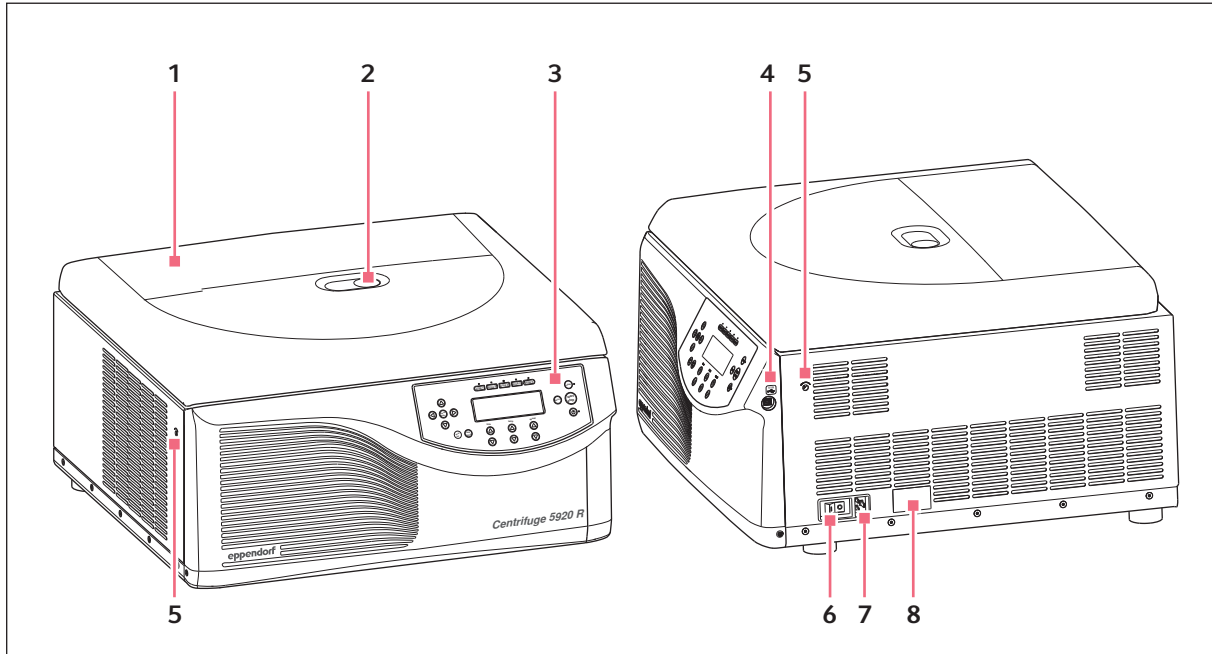


Fig. 3-1: Centrifuge 5920 R: Front and side view

- | | |
|--|--|
| 1 Centrifuge lid | 5 Emergency release |
| 2 Monitoring glass
Visual control for rotor stop or speed control option using stroboscope | 6 Mains/power switch
Switch for switching the centrifuge on and off. |
| 3 Control panel
Display and keys for operating the centrifuge. | 7 Mains/power cord socket
Connection for supplied power cable |
| 4 USB interface
Only for Technical Service: interface for software updates. | 8 Name plate |

Product description

Centrifuge 5920 R
English (EN)

3.2 Delivery package

1	Centrifuge 5920 R refer to <i>Ordering Information</i> for the corresponding device version, equipment and order number
1	Rotor key
1	Power cable
1	Operating instructions Languages: EN, DE, FR, ES, IT, PT
1	Operating instructions Languages: DA, EL, FI, NL, SV (230 V devices only)



- ▶ Check the delivery for completeness.
- ▶ Check all parts for damage in transit.
- ▶ To safely transport and store the device, keep the transport box and packing material.

3.3 Features

The versatile Centrifuge 5920 R has a capacity of 4 × 1000 mL and reaches a maximum of 22 132 × *g* or 14000 rpm. The versatility is reflected in the available rotor options. You can select from 13 different rotors to centrifuge the following tubes for various applications:

- Tubes (0.2 mL to 5.0 mL)
- PCR strips
- Microtainers
- Spin columns
- Cryotubes
- Conical tubes (15 mL, 50 mL)
- Bottles (175 mL to 1 000 mL)
- Various tubes (3 mL to 120 mL)
- Microplates
- PCR plates
- Deepwell plates
- Slides (with CombiSlide adapter)
- Blood collection systems

Handling the centrifuge is facilitated by:

- Automatic rotor detection with rotational speed limit
- Automatic rotor imbalance detection
- Clear digital display

The centrifuge has 99 program spaces for user-defined settings and 10 different acceleration and braking ramps.

The possibility of setting the radius manually ensures maximum rcf accuracy.

The Centrifuge 5920 R also features a temperature control function for centrifuging at temperatures from -11 °C to 40 °C. Use the **FastTemp** function to start a temperature control run without samples to bring the rotor chamber incl. rotor, carriers and adapters to the set target temperature quickly. Continuous cooling also maintains the temperature in the rotor chamber with the centrifuge lid closed when the centrifuge is not in use.

4 Installation

4.1 Selecting the location



WARNING! Risk of fire.

Due to the high current consumption of the centrifuge, an overload may occur if the network is not secure.

- ▶ Only connect the centrifuge to an electric circuit that has its own protection.
 - ▶ Do not connect any devices to the circuit other than the centrifuge.
-



NOTICE! If an error occurs, the objects in the immediate proximity of the device will be damaged.

- ▶ In accordance with the recommendations of EN 61010-2-020, leave a safety clearance of **30 cm** around the device during operation.
- ▶ Please remove all materials and objects from this area.



NOTICE! Damage from overheating.

- ▶ Do not place the device near heat sources (e.g., heating, drying cabinet).
- ▶ Do not expose the device to direct sunlight.
- ▶ Ensure unobstructed air circulation. Maintain a clearance of at least 30 cm (11.8 in) around all ventilation slits.



NOTICE! Radio interference.

This device is a category A product in accordance with EN 55011. There may be disturbance to radio reception in residential areas.

- ▶ Ensure that appropriate preventive measures are taken.
-



The mains/power switch and cutting unit of the mains/power line must be easily accessible during operation (e.g, residual current circuit breaker).

Select the location for the device according to the following criteria:

- Mains connection in accordance with the name plate.
- Minimum distance to other devices and walls: 30 cm (11.8 in).
- A resonance-free bench with a horizontal and even work surface which is designed to support the weight of the device.
- The location area must be well ventilated.
- The location must be protected from direct sunlight.

4.2 Preparing installation

The weight of the centrifuge is 139.0 kg (306.44 lb).



CAUTION! Risk of injury when lifting and carrying heavy loads

- ▶ Use a mechanical lifting aid when installing the device.

Unpacking the centrifuge

1. Open the packaging board.
2. Remove accessories.
3. Remove the transport securing devices.
4. Remove the plastic sleeve.
5. Lift the centrifuge out of the cardboard box by means of a suitable mechanical lifting aid.
6. Place the device on a suitable lab bench.

4.3 Installing the instrument

Prerequisites

The device is on a suitable lab bench.



WARNING! Risk from incorrect supply voltage

- ▶ Only connect the device to voltage sources which correspond to the electrical requirements on the name plate.
- ▶ Only use sockets with a protective earth (PE) conductor and suitable power cable.



NOTICE! Damage to electronic components due to condensation.


Condensate can form in the device after it has been moved from a cool environment to a warmer environment.

- ▶ After installing the device, wait for at least 4 h. Only then connect the device to the mains/power line.



NOTICE! Centrifuge 5920 R: Compressor damage after improper transport.

- ▶ After installation, wait 4 hours before switching on the centrifuge.

1. Let the device warm up to ambient temperature.
2. Connect the centrifuge to the mains and switch it on using the mains/power switch.
 - The LED next to the **Standby**  key lights up.
 - The display is active.
3. Open the centrifuge lid with the **open** key.

5 Operation

5.1 Operating controls

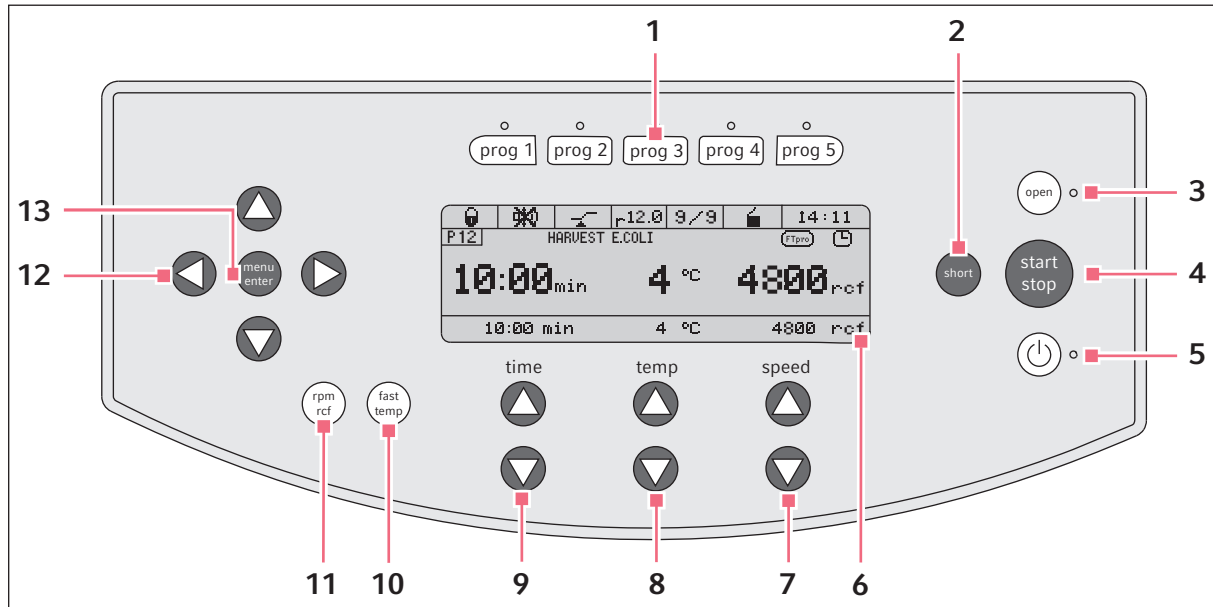



Fig. 5-1: Operating controls Centrifuge 5920 R

- | | |
|--|--|
| <p>1 Program keys
Press the program key: Load program
Keep the program key pressed for 2 s: Save current parameters</p> <p>2 short key
Short spin centrifugation</p> <p>3 open key
Release lid</p> <p>4 start/stop key
Start and stop centrifugation</p> <p>5 Standby  key
Activate/deactivate standby mode
LED lights up green: centrifuge is ready for operation.
LED lights up red: standby mode is active.</p> <p>6 Display</p> <p>7 Arrow keys speed
Set centrifugation speed
Keep the arrow key pressed: Quick setting</p> | <p>8 Arrow keys temp
Setting the temperature
Keep the arrow key pressed: Quick setting</p> <p>9 Arrow keys time
Set centrifugation time
Keep the arrow key pressed: Quick setting</p> <p>10 fast temp key
Start FastTemp temperature control run</p> <p>11 rpm/rcf key
Switch display of centrifugation speed (rpm or rcf)</p> <p>12 Menu arrow keys
Navigate the menu</p> <p>13 menu/enter key
Open menu
Confirm your selection</p> |
|--|--|

Operation

Centrifuge 5920 R
English (EN)

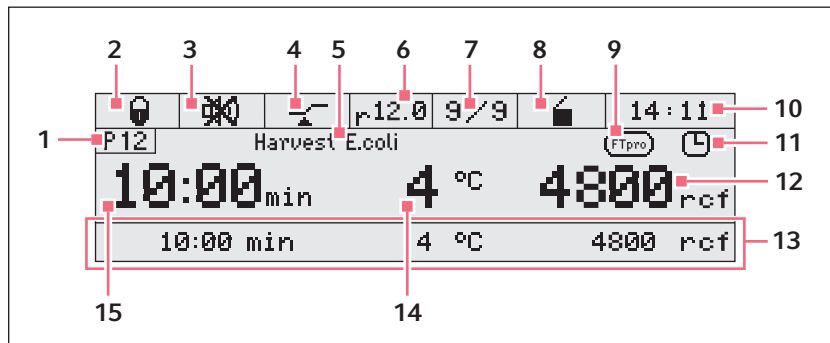


Fig. 5-2: Display Centrifuge 5920 R

1 Program number

2 Key lock

- 🔒 Key lock activated: Parameters cannot be changed.
- 🔓 No key lock.

3 Speaker

- 🔊 Speaker switched on.
- 🔇 Speaker switched off.

4 At set rpm function

- 📉: the set run time will be counted down when 95 % of the specified *g*-force (rcf) or speed (rpm) has been reached.
- 📈: time counting begins immediately.

5 Program name

6 Radius

7 Ramps

Accelerating and braking of the rotor.

8 Status of centrifuge

- 🔒 centrifuge lid unlocked.
- 🔒 centrifuge lid locked.
- 🔄 (flashing): centrifuging in progress.

9 FastTemp pro

🔒 FastTemp pro has been enabled. The start time and the temperature of the temperature control run are programmed.

10 Time

11 Timer

🕒 Timer set: delayed start (in programs only).

12 *g*-force (rcf) or speed (rpm)

Actual value

13 Set value row

Set values for centrifugation time, temperature, centrifugation speed. Visible, if *Extended display* has been enabled in the settings.

14 Temperature

Actual value

15 Centrifugation time

Actual value

5.2 Switching on the centrifuge

1. Switch on the centrifuge using the mains power switch or the **Standby** Ⓞ key.
The parameter settings of the last run are displayed.
2. Press the **open** key to open the closed centrifuge lid.

5.3 Initial steps

5.3.1 Setting the menu language

1. Open menu: press the **menu/enter** key.
2. Use the menu arrow keys to select *Settings*. Confirm with the **menu/enter** key.
3. Use the menu arrow keys to select *Language*. Confirm with the **menu/enter** key.
4. Use the menu arrow keys to select *Deutsch, Francais, English* or *Espanol*. Confirm with the **menu/enter** key.
A checkmark appears in front of the selected language. The setting takes effect immediately.
5. To exit the menu, press the left menu arrow key ◀ several times.

5.3.2 Setting date and time

1. Open menu: press the **menu/enter** key.
2. Use the menu arrow keys to select *Settings*. Confirm with the **menu/enter** key.
3. Use the menu arrow keys to select *Date/Time*. Confirm with the **menu/enter** key.
4. Use the menu arrow keys to select *International Time* or *US-Time (AM/PM)*. Confirm with the **menu/enter** key.
5. Set the date and time with the menu arrow keys. Confirm with the **menu/enter** key.
6. To exit the menu, press the left menu arrow key ◀ several times.



The time does not change automatically from summer time to winter time.

5.4 Replacing the rotor



NOTICE! If handled incorrectly, the rotor may fall.

The swing-bucket rotor may fall if the buckets are used as handles.

- ▶ Remove the buckets before inserting and/or removing a swing-bucket rotor.
- ▶ Always use both hands to carry the rotor cross.

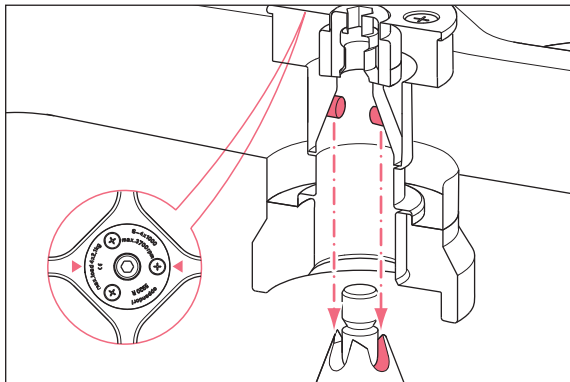


NOTICE! Material damage due to improper rotor insertion.

The motor shaft or bearing may get damaged if the rotor falls into the motor shaft guides in an uncontrolled manner during insertion.

- ▶ Hold the rotor with both hands.
- ▶ Guide the rotor onto the motor shaft.

5.4.1 Inserting the rotor



1. Place the rotor vertically onto the motor shaft from the top.
The arrows on the rotor show the position of the pegs. The pegs of the rotor must fit into the motor shaft guides. If required, lift the rotor and place it onto the motor shaft again.
2. Insert the rotor key supplied into the rotor nut.
3. Turn rotor key **clockwise** until the rotor nut is firmly tightened.

5.4.2 Removing the rotor

1. Turn the rotor nut **counterclockwise** using the rotor key supplied.
2. Remove rotor by lifting it vertically.

5.4.3 Triggering rotor detection



CAUTION! Risk of injury when turning the rotor manually.

- ▶ When turning a swing-bucket rotor, pay special attention to ensure that your fingers do not get jammed or get caught on the swinging buckets.

The centrifuge detects a newly inserted rotor if the rotor is moved at low speed.

- ▶ In order to trigger rotor detection manually, turn the rotor **counterclockwise** by hand.
 - The name of the rotor appears in the display.
 - If the g -force (rcf) or speed (rpm) has been set higher, it will be limited to the maximum value of the rotor.



Triggering rotor detection using short-spin centrifugation

- ▶ Press and hold the **short** key until the name of the rotor appears on the display.

If you start centrifuging immediately after a rotor change, then the centrifuge has not yet detected the new rotor. If the set g -force/speed is higher than the maximum permitted g -force/speed of the new rotor, the following message appears in the display:

```
rpm/rcf too high!  
[START] Centrifugation at ### rpm/### rcf  
◀ ▶ Change parameters.
```

- The message shows the maximum permitted g -force/speed of the new rotor.
 - The rotor is not stopped, but it is held at a speed of 700 rpm.
 - You have 15 seconds to adopt the g -force/speed or to change it.
- ▶ Adopt the displayed g -force/speed for the run: Press the **start/stop** key.
 - ▶ To change the g -force or speed for the run: use the arrow keys **speed** to set a different value.

If you do not adopt or change the g -force/speed within 15 s, the centrifuge will stop running. The display shows the error message *Hint C*.



- ▶ After each rotor change, check whether the new rotor is detected by the device.
- ▶ Check the set g -force (rcf) and/or speed (rpm) and adjust it, if required.

5.5 Loading a fixed-angle rotor



CAUTION! Risk of injury due to asymmetric loading of the rotor.

- ▶ Load rotors symmetrically with identical tubes.
- ▶ Only load adapters with suitable tubes.
- ▶ Always use the same type of tubes (weight, material/density and volume).
- ▶ Check symmetric loading by balancing the adapters and tubes used with scales.

1. Check the maximum payload (adapter, tube and contents) for each rotor bore.
2. Load rotors and adapters only with the tubes intended for them.
3. To ensure symmetrical loading, insert sets of two tubes in opposite bores. Tubes located opposite each other must be of the same type and contain the same filling quantity.

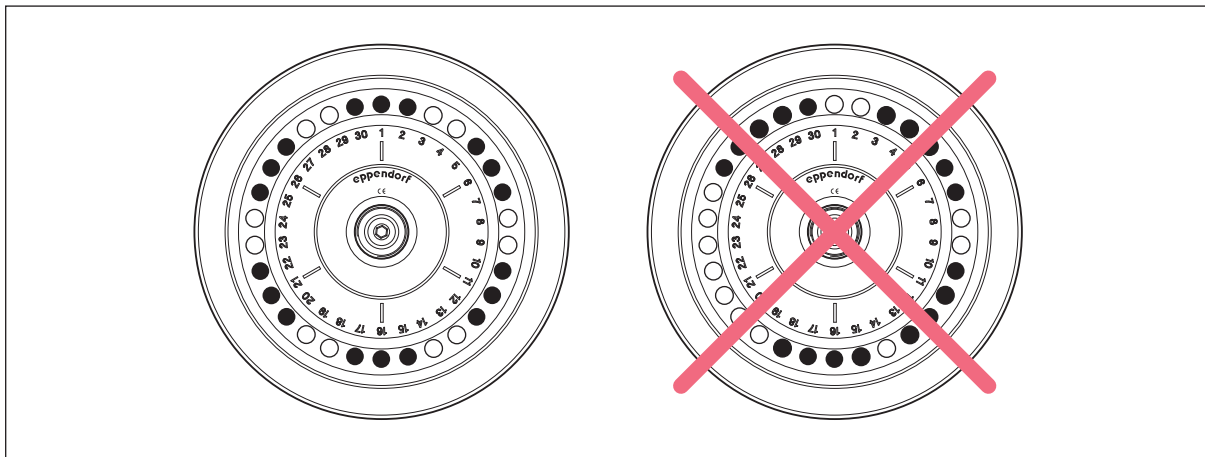


Fig. 5-3: Symmetrical loading of a fixed-angle rotor

To keep the weight differences between the filled tubes low, we recommend taring with a balance. This will reduce wear on the drive and reduce operating noise.

5.5.1 Closing the rotor lid



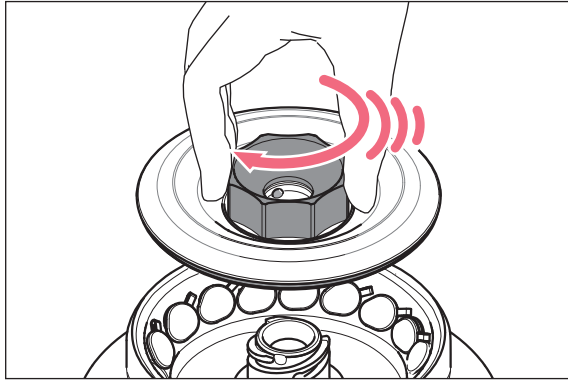
Use matching rotor lids

- Fixed-angle rotors may only be operated with the appropriate rotor lid in each case. The rotor name on the rotor must correspond to the rotor name on the rotor lid.
- To carry out an aerosol-tight centrifugation, an aerosol-tight rotor (label: **red ring**) and the corresponding aerosol-tight rotor lid (label: **aerosol-tight** and **red lid screw**) must be used.

1. Fit the rotor lid vertically onto the rotor.
2. Turn the rotor lid screw clockwise to seal the rotor.

5.5.2 Closing the QuickLock rotor lid

Aerosol-tight rotors have a QuickLock rotor lid.



1. Check the correct positioning of the external sealing ring in the groove.
2. Place the rotor lid on the rotor in a vertical motion.
3. To lock the rotor, turn the red rotor lid screw clockwise as far as it will go, and after an audible "click" is heard.



The rotor is correctly locked after the audible "click" is heard!

5.6 Loading the swing-bucket rotor



CAUTION! Risk of injury due to asymmetric loading of the rotor.

- ▶ Load rotors symmetrically with identical tubes or plates and buckets.
- ▶ Always load all positions of a swing-bucket rotor with buckets.
- ▶ Only load adapters with suitable tubes or plates.
- ▶ Always use tubes or plates of the same type (weight, material/density and volume).
- ▶ Check that loading is symmetrical by balancing the adapters and tubes or plates used with scales.

5.6.1 Inserting the bucket in the swing-bucket rotor

Prerequisites

- The combination of rotor, carrier and adapter has been approved by Eppendorf.
- Buckets that are located opposite each other belong to the same weight class. The weight class is engraved in the sides of the groove: e.g., 68.
- Matching and tested tubes and plates.



The swing-bucket rotor runs more smoothly if all buckets are loaded symmetrically with the same weight.

- ▶ To reduce noise and vibrations, load the buckets of the swing-bucket rotor with the same weight.

1. Check that the bucket grooves are clean. Use pivot grease to lightly lubricate the grooves.
2. Hang the buckets into the rotor.
All rotor positions must be equipped with buckets.
3. Check to see if all buckets are completely hung and can freely swing out.
4. Check the maximum load per carrier (adapter, tube or plate and contents) and the loading height.
5. Load the buckets symmetrically.



- ▶ When using a vessel type or plate type for the first time, carry out a brief test run at low speed (e.g. 1000 rpm).

5.6.2 Performing an imbalance calibration

Carry out a manual imbalance calibration when you use a tube or plate for the first time. Always carry out a manual imbalance calibration when you use tubes with a length of > 100 mm.

- ▶ Inserting plates and/or tubes.
- ▶ Swing the bucket and/or the plate buckets manually up to 90°.
 - The vessel or plate bucket swings freely.
 - The tubes do not touch the rotor cross.

5.6.3 Loading the buckets symmetrically



NOTICE! Material damage due to incomplete loading of the swing-bucket rotor.
Incomplete loading of the swing-bucket rotor reduces the rotor's service life.

- ▶ Always load all positions of a swing-bucket rotor with buckets.

5.6.3.1 Equipping buckets with vessels

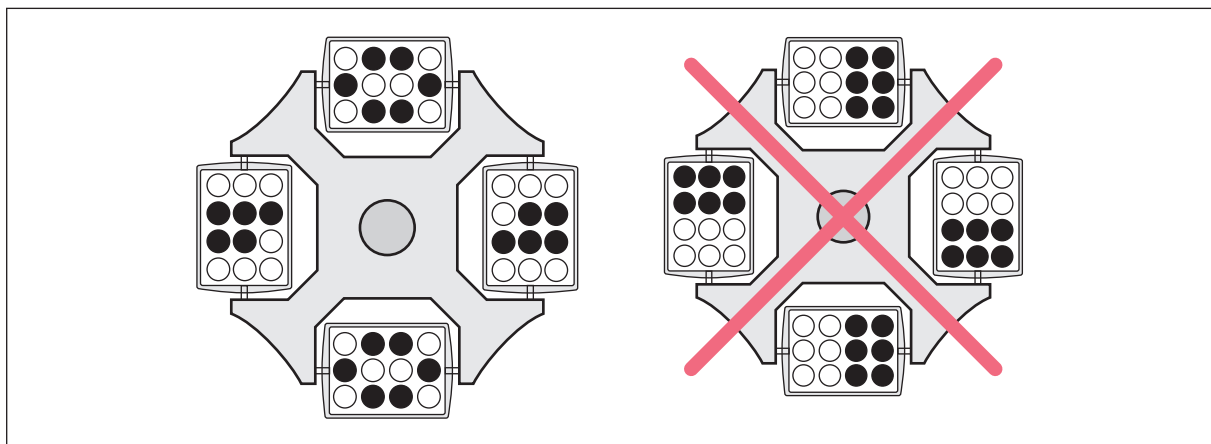


Fig. 5-4: Incomplete, but symmetric loading of the buckets.

The loading shown on the right-hand side is incorrect as it places an uneven load on the pegs of the rotor.

- ▶ To reduce vibrations and noise, load all buckets of the swing-buckets rotor equally.

5.6.3.2 Loading plates symmetrically



NOTICE! Filling the plates too high can cause overflowing.

During the run the meniscuses in the tubes along the edges of the plates are at an angle. This is due to the centrifugal forces and cannot be avoided.

- ▶ Fill the plate wells to a maximum of $2/3$ of the maximum filling volume.

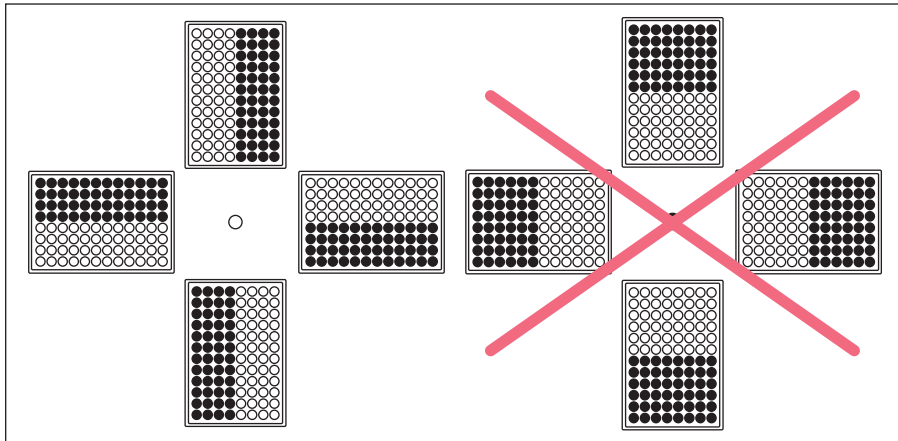


Fig. 5-5: Symmetrical loading of plates

- ▶ In order to avoid imbalances, always load the plates symmetrically.

The plate loading shown on the right-hand side is incorrect as the buckets will not swing properly if loaded in this way.

5.6.3.3 Rotor S-4x750: Equipping the adapter with vessels > 119 mm

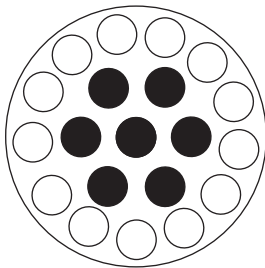


NOTICE! Broken glass due to incorrect loading.

If the tubes in a bucket are too long, the swinging tubes will touch the rotor cross and may get damaged or destroyed.

- ▶ Load buckets such that they can swing out freely.
- ▶ If necessary, load only the inner bores of the adapter.
- ▶ When using tubes with a length of > 100 mm: always perform a manual swing-out test.

If the adapter 16 × 75 mm – 100 mm (order number 5825 736.001) is equipped with vessels > 119 mm, e.g. BD 8 mL Vacutainer, this will result in danger of glass breakage.



- ▶ Only equip the inner bores.

5.6.3.4 Rotor S-4x1000: Centrifugation of flasks 1000 mL

- ▶ When using 1000 mL flasks in the rotor S-4x1000, equip all 4 buckets with one flask each. Centrifuging with 2 loaded buckets only is not possible.

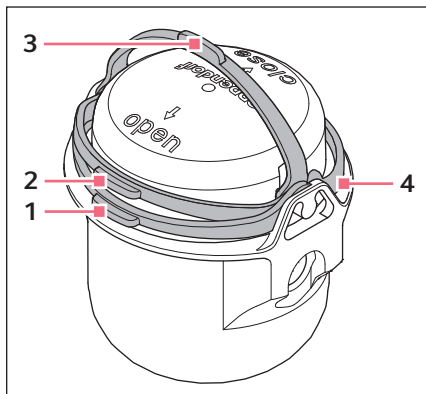
5.6.4 Closing the bucket with the cap



NOTICE! Damage to the cap hook.

If the cap is not positioned correctly on the bucket, the sealing clamp may break during closing.

- ▶ Before you fold the sealing clamp, check that the cap is positioned correctly.



1. Fold the cap clamp to the **open** position (1).
2. Place the cap on the bucket and push the cap down in such a way that the clamp is lifted slightly (2).
3. To transport the bucket, fold the clamp to the carrying position (3).
4. To seal the bucket so that it is aerosol-tight, fold the clamp beyond the latch into the **close** position.
The clamp has only been folded correctly if there is an audible *click* (4).

5.6.5 Mixed loading with buckets and plate carriers

Mixed loading of swing-bucket rotors with buckets and plate carriers is possible if these are intended for the rotor. Buckets or plate carriers which are opposite each other must be buckets/plate carriers of the same type.

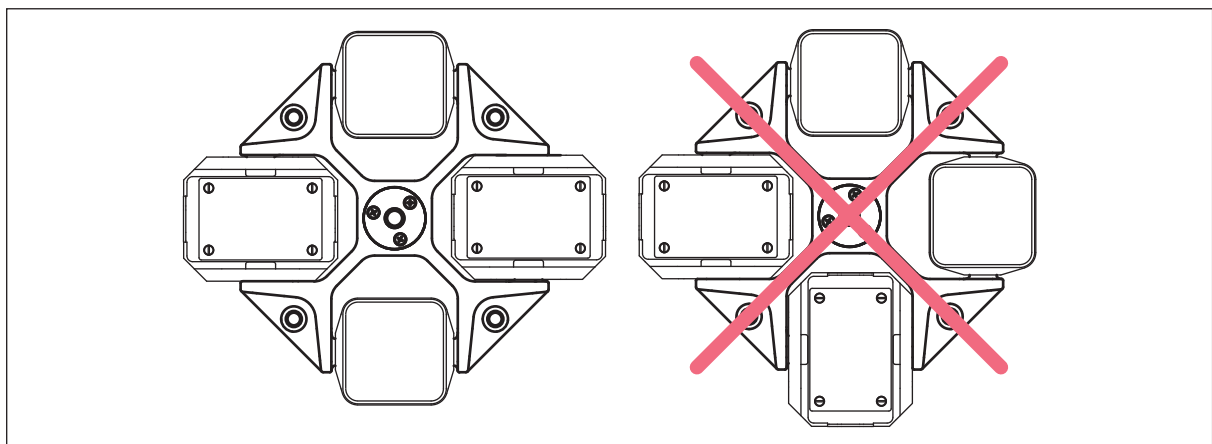


Fig. 5-6: Mixed loading of a swing-bucket rotor


5.7 Closing the centrifuge lid



WARNING! Risk of injury when opening or closing the centrifuge lid.

There is a risk of crushing your fingers when opening or closing the centrifuge lid.

- ▶ When opening or closing the centrifuge lid, do not reach between the lid and device or into the latching mechanism of the lid.
 - ▶ Always open the centrifuge lid completely to prevent it from falling.
-

1. Check that the rotor is attached correctly.
2. Press the centrifuge lid down until it is gripped by the lid latch. The lid will be closed automatically.
 - The LED next to the **open** key lights up in blue.
 - The  symbol appears on the display.

5.8 Aerosol-tight centrifugation



WARNING! Risk to health due to limited aerosol tightness with incorrect rotor/rotor lid combination.

Aerosol-tight centrifugation is guaranteed only if the rotors and rotor lids intended for this purpose are used. The designation of aerosol-tight fixed-angle rotors always starts with **FA**. The aerosol-tight rotors and rotor lids of this centrifuge are additionally marked with a red ring on the rotor and a red rotor lid screw.

Aerosol-tight swing-bucket rotors are marked **AT** (aerosol-tight).

- ▶ For aerosol-tight centrifugation, always simultaneously use rotors and rotor lids which are marked as aerosol-tight in the centrifuge intended for the corresponding purpose. The details specifying in which centrifuge you may use the aerosol-tight rotors and rotor lids can be found on the rotor and, beginning from production date of October 2003, on the upper side of the rotor lid.
- ▶ Only use aerosol-tight rotor lids in combination with rotors which are marked on the rotor lid.



WARNING! Damage to health due to limited aerosol tightness in the event of incorrect use.

Autoclaving, mechanical stresses and contamination by chemicals or other aggressive solvents can impair the aerosol tightness of the rotors and rotor lids.

- ▶ Check the integrity of the seals of the aerosol-tight rotor lids or caps before each use.
- ▶ Only use aerosol-tight rotor lids or caps if the seals are undamaged and clean.
- ▶ Apply a thin layer of pivot grease to the threads of the rotor lid screw after each proper autoclaving process (121 °C, 20 min.). (Order no. Int. 5810 350.050, North America 022634330).
- ▶ Replace aerosol-tight rotor lids and caps after 50 autoclaving cycles.
- ▶ For QuickLock rotor lids, the seal must be replaced after 50 autoclaving cycles.
- ▶ **Never** store aerosol-tight rotors or buckets closed.



The aerosol tightness of rotors, rotor lids, buckets and caps has been tested and certified in accordance with Annex AA of IEC 1010-2-020.

Measures to ensure aerosol tightness

- ▶ Replace aerosol-tight rotor lids and aerosol-tight caps after 50 autoclaving cycles.
- ▶ Replace the seal of QuickLock rotor lids after 50 autoclaving cycles.

5.8.1 Aerosol-tight centrifugation in a fixed-angle rotor

Aerosol-tight fixed-angle rotors have a QuickLock rotor lid (see *Closing the QuickLock rotor lid on p. 25*).

5.8.2 Aerosol-tight centrifugation in a swing-bucket rotor

- ▶ For aerosol-tight centrifugation in a swing-bucket rotor, use buckets with aerosol-tight caps (see *Closing the bucket with the cap on p. 30*).

5.9 Centrifuging

Prerequisites

- The centrifuge is switched on.
- The rotor has been inserted and attached correctly.
- The rotor has been loaded correctly.
- The rotor lid has been mounted correctly.
- Buckets can freely swing out.
- The centrifuge lid is closed.



WARNING! Risk of injury from improperly attached rotors and rotor lids.

- ▶ Only centrifuge with rotor and rotor lid firmly tightened.
- ▶ If there are any unusual noises when the centrifuge is started up, the rotor or rotor lid may not be properly attached. Immediately press the **start/stop** key to stop centrifuging.

5.9.1 Centrifugation with time setting

Setting the centrifugation parameters


1. Set the centrifugation time with the **time** arrow keys.
2. Set the temperature with the **temp** arrow keys.
3. Set the speed (rpm) or the *g*-force (rcf) with the **speed** arrow keys.

If the speed is set via the *g*-force (rcf): check the radius (see *Setting the radius on p. 35*).

Starting the centrifugation run

4. To start the centrifugation run, press the **start/stop** key.

Display during centrifugation


-  blinks in the display when the rotor is running.
- Remaining run time in minutes. The last minute is counted down in seconds.
- Current temperature in the rotor chamber.
- Current *g*-force (rcf) and/or speed (rpm).
- Target values for centrifugation time, temperature and centrifugation speed in the target value row (if activated).



During the run you can change the following parameters:

- Centrifugation time: The shortest new run time that can be set must be 2 min above the elapsed time.
- Temperature
- Regulating the speed
During the run you can switch between the display of the *g*-force and the speed, using the **rpm/rcf** key.
- Radius
- Acceleration ramp/braking ramp

The following keys are blocked during centrifugation:


- **Standby**  key
- **open** key
- **short** key
- Program keys **prog 1** to **prog 5**

5.9.2 End of centrifugation

- ▶ Press the **start/stop** key to end centrifugation before the set time.
 - The centrifuge automatically stops after the set time has elapsed.
 - During the braking process, the elapsed running time flashes on the display.
 - The signal sounds when the rotor is stopped.
 - Time counter after rotor stop: A window on the display counts the time from the rotor stop to 10:00 h. Additionally, > 10:00 h is displayed.
 - The **open** key flashes. The centrifuge lid remains sealed. Press the **open** key to open the lid.

5.9.3 Centrifuging in continuous operation

Setting up continuous operation

1. In order to centrifuge without any time limits, use the **time** arrow keys to select the setting **oo** (▼ below 10 s or ▲ above 99:59 h).
2. Set the temperature with the **temp** arrow keys.
3. Set the speed (rpm) or the *g*-force (rcf) with the **speed** arrow keys.
If the speed is set via the *g*-force (rcf): check the radius (see *Setting the radius on p. 35*).
4. To start the centrifugation run, press the **start/stop** key.
 -  blinks in the display when the rotor is running.
 - The cycle time is counted up.
 - Current temperature in the rotor chamber.
 - Current *g*-force (rcf) and/or speed.
5. Press the **start/stop** key to end the centrifugation.
 - During the braking process, the elapsed running time flashes on the display.
 - The signal sounds when the rotor is stopped.
6. Press the **open** key to open the lid.


5.9.4 Short spin centrifugation

Prerequisites

Setting in the menu item *Short spin*:

- *Maximum speed*: Short spin centrifugation at the maximum speed of the inserted rotor.
- *Current speed*: Short spin centrifugation at a freely selected speed.

The short spin centrifugation runs as long as the **short** key is pressed.

1. For short-spin centrifugation with *Current speed* only: set the speed (rpm) or the *g*-force (rcf) with the **speed** arrow keys.
2. Set the temperature with the **temp** arrow keys.
3. Press and hold the **short** key to start short-spin centrifugation.
 -  blinks in the display when the rotor is running.
 - All other keys are disabled during short spin centrifugation.
4. Release the **short** key to end short-spin centrifugation.
During the braking process, the elapsed running time flashes on the display.
5. Press the **open** key to open the lid.



The soft ramp is disabled during short spin centrifugation.

5.9.5 Setting the radius

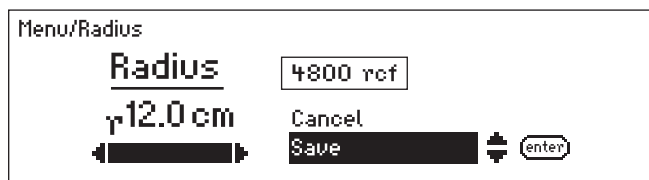
Prerequisites

The centrifuge has detected the rotor.

The value for the radius is set to the maximum radius of the rotor.

As a standard, the conversion from speed to *g*-force is based on the biggest radius of the rotor. If you are using an adapter for tubes, you can adjust the value for the radius manually. You can find the value for the radius of an adapter in a rotor in the Technical data of the rotor.

1. Press the **menu/enter** key. Use the menu arrow keys to select *Radius*. Confirm with the **menu/enter** key.



The display shows the maximum radius of the rotor and the *g*-force (rcf) in accordance with the set speed.

2. Use the menu arrow keys ◀ or ▶ to set the radius for the adapter.
The *g*-force (rcf) is adjusted to the value of the radius.
3. Select *Save* with the menu arrow keys ◀ or ▶. Confirm with the **menu/enter** key.
4. To exit the menu, press the left menu arrow key ◀ several times.

5.9.6 Setting the acceleration ramp and braking ramp

You can set the acceleration and braking times in levels from 0 to 9.

- Level 9: shortest acceleration time/braking time (setting on delivery).
- Level 0: longest acceleration time/braking time

1. Press the **menu/enter** key. Use the menu arrow keys to select *Ramps*. Confirm with the **menu/enter** key.
2. Use the menu arrow keys ▲ or ▼ to select *Accel. ramp* ↗ or *Braking ramp* ↘.
3. Use the menu arrow keys ◀ or ▶ to select the level.
4. Select *Save* with the menu arrow keys ◀ or ▶. Confirm with the **menu/enter** key.

5.9.7 Setting the beginning of time counting (*At set rpm* function)

You can specify when time counting should begin:

- Time counting begins immediately: *At set rpm > Off* ⚡ (setting on delivery).
- Time counting starts when 95 % of the speed has been reached: *At set rpm > On* ⚡

1. Press the **menu/enter** key. Use the menu arrow keys to select *At set rpm*. Confirm with the **menu/enter** key.
2. Use the menu arrow keys ▲ or ▼ to select *Off* ⚡ or *On* ⚡. Confirm with the **menu/enter** key.
The display shows ⚡ or ⚡.

5.10 Cooling

The centrifuge cools or maintains the set temperature if the following requirements are met:

- The centrifuge is switched on.
- The centrifuge lid is closed.
- Only with continuous cooling: The set temperature is lower than the ambient temperature.



- The temperature that can actually be reached depends on the rotor and the set rotational speed.
- If the rotor stops (continuous cooling), cooling is slower than during centrifugation or a temperature control run.

5.10.1 Set temperature

1. To set the temperature, use the **temp** arrow keys to select a temperature between -11 °C and 40 °C.
2. Set the run time and *g*-force (rcf) or speed (rpm). Press the **start/stop** key to start the centrifugation.
The temperature can be changed during centrifugation.

5.10.2 Temperature display

Temperature display if the rotor stops:	Set temperature
Temperature display during centrifugation:	Actual temperature

When the *Display > Extended display* setting is activated, the display shows the target values for centrifugation time, temperature and centrifugation speed in the target value row.

5.10.3 Temperature monitoring

After the set temperature has been reached, the centrifuge reacts to temperature deviations during centrifugation as follows:

Deviation from the target temperature $> \pm 3$ °C:	Temperature display flashes.
Deviation from the target temperature $> \pm 5$ °C:	Display shows <i>Err 18</i> . Centrifugation is stopped automatically.

5.10.4 Temperature control run FastTemp

Prerequisites

- The centrifuge is switched on.
- Rotor and rotor lid are correctly mounted.
- The centrifuge lid is closed.
- The temperature and *g*-force (rcf) or speed (rpm) have been set for the upcoming centrifugation .

With the FastTemp function, you can immediately start a temperature run without samples, at rotor-specific or temperature-specific speeds. This will quickly bring the rotor chamber, including rotor and adapter, up to the set target temperature.

1. Set the temperature with the **temp** arrow keys.
2. Press the **fast temp** key.

The display shows the following information:

- *FastTemp*
 - Duration of the temperature control run
 - Actual temperature in the rotor chamber
 - The optimum speed (rpm) calculated for the temperature control run or the *g*-force (rcf).
3. The temperature control run FastTemp ends automatically when the target temperature has been reached.
The signal sounds 5 times.

Press the **start/stop** key to end the temperature control run early.



- The centrifuge only stops the run once the rotor has reached the set temperature. Therefore, there may be a delay between the display of the achieved target temperature and the automatic end of the temperature control run.
- The target temperature can be changed during the temperature control run, using the **temp** arrow keys. Duration and speed are adjusted automatically.



FastTemp with aerosol-tight buckets

A temperature control run with aerosol-tight buckets takes longer and may lead to a vacuum in the bucket.

- ▶ Do not seal aerosol-tight buckets during a FastTemp run.
- ▶ If the caps cannot be undone due to a vacuum, do not pull on the sealing clamps or hooks to loosen the cap. Adjust the temperature of the buckets to room temperature so that the caps can be removed easily.

5.10.5 FastTemp pro: Automatic temperature control run with programmed start time

Prerequisites

- The centrifuge switches on and/or is in the standby mode at the set time.
- Rotor and rotor lid are correctly mounted.
- The centrifuge lid is closed.

You can set the FastTemp temperature control run to start automatically at a set time. Two options are available:

- *FastTemp pro > One time use*: The temperature control run starts once at the set time.
- *FastTemp pro > Repeated use*: The temperature control run starts at the set time on the set weekday and repeats indefinitely on each additional weekday that was set.

The selection between *One time use* and *Repeated use* only appears when the FastTemp pro function has not been activated yet. If this is not the case, you can edit or delete the programmed start time.

Programming a single temperature control run

1. Press the **menu/enter** key. Use the menu arrow keys to select *Cooling System > FastTemp pro*.
2. Use the menu arrow keys to select *One time use*. Confirm with the **menu/enter** key.
3. Set the date, time and temperature with the menu arrow keys. Confirm with the **menu/enter** key.
The display shows an overview of the current settings.
4. Use the menu arrow keys to select *Save*. Confirm with the **menu/enter** key.

Programming repeated temperature control runs

1. Press the **menu/enter** key. Use the menu arrow keys to select *Cooling System > FastTemp pro*.
2. Use the menu arrow keys to select *Repeated use*. Confirm with the **menu/enter** key.
3. Activate or deactivate the weekdays with **menu/enter**. Select *Next* and confirm with **menu/enter**.
4. Set the date, time and temperature with the menu arrow keys. Confirm with the **menu/enter** key.
The display shows an overview of the current settings.
5. Use the menu arrow keys to select *Save*. Confirm with the **menu/enter** key.
 - When FastTemp pro is activated, the **FTpro** symbol appears on the display while an automatic start of a temperature control run is still outstanding.
 - The temperature control run starts automatically at the selected time.
 - After a one-off programmed temperature control run, the following symbol is extinguished **FTpro**. If there are several programmed temperature control runs, the FastTemp pro function remains active indefinitely.



If the centrifuge is running at the programmed time, the temperature control run cannot be started automatically.

Deactivating FastTemp pro

1. Press the **menu/enter** key. Use the menu arrow keys to select *Cooling System > FastTemp pro*.
2. Use the menu arrow keys to select *Delete*. Confirm with the **menu/enter** key.

5.10.6 Continuous cooling

Prerequisites

- The centrifuge is switched on.
- The centrifuge lid is closed.
- The set temperature is lower than the ambient temperature.

Continuous cooling maintains the rotor chamber at the set temperature if the rotor stops.

- During continuous cooling the display shows the set temperature.
- To prevent the rotor chamber from freezing or condensation from forming, the temperature does not go below 4 °C, irrespective of the set temperature.
- If the rotor stops, temperature control is slower than during centrifugation or a temperature control run.

ECO shut-off

ECO shut-off: Continuous cooling is switched off if the centrifuge is not in use for longer than the preset time. The centrifuge switches to standby mode.

- Default setting: Continuous cooling ends after 8 h.
- Continuous cooling can be limited to 1 h, 2 h or 4 h.
- ECO shut-off can be switched off (continuous cooling set to endless operation).

Limit continuous cooling to 1 h (2 h, 4 h, 8 h).

1. Press the **menu/enter** key. Use the menu arrow keys to select *Cooling System > Continuous cooling*. Confirm with the **menu/enter** key.
2. Use the menu arrow keys to select *Eco shut-off*. Confirm with the **menu/enter** key.
3. Select *1 h, 2 h, 4 h or 8 h*. Confirm with the **menu/enter** key.
Continuous cooling ends after the preset time. The centrifuge switches to standby mode.

5.10.7 Endless operation of continuous cooling

The ECO shut-off function can be switched off. Continuous cooling is changed to endless operation.

- Endless operation can shorten the service life of the compressor.
- The rotor chamber may freeze.

1. Press the **menu/enter** key. Use the menu arrow keys to select *Cooling System > Continuous cooling*. Confirm with the **menu/enter** key.
2. Use the menu arrow keys to select ∞ . Confirm with the **menu/enter** key.

Ending continuous cooling

3. Open the centrifuge lid to end continuous cooling.

5.11 Switching off the centrifuge

1. Open the centrifuge lid.
Residual moisture can evaporate. Pressure is taken off the gas springs.
2. Remove rotor lids from fixed-angle rotors and aerosol-tight caps from buckets.
Aerosol-tight accessories may not be stored when they are connected.
3. Switch off the centrifuge using the mains/power switch.

6 Device settings

6.1 Standby mode


The centrifuge automatically switches from the ready state to the standby mode if the following prerequisites are met:


- The centrifuge is not used during the defined time period.
- The centrifuge lid is open.

Standby mode

- The LED next to the **Standby**  key lights up red.

Ready state

- The centrifugation parameters are displayed.
- The LED next to the **Standby**  key lights up green.

You can switch between the standby mode and ready state at any time when centrifugation is not performed by pressing the **Standby**  key.

6.1.1 Switching on the standby mode

1. Press the **menu/enter** key. Use the menu arrow keys to select *Settings > Standby*.
2. Use the menu arrow keys to select *OnOff* or *Set time*. Confirm with the **menu/enter** key.
If *Standby > Set time* is selected, the time period can be selected after which the centrifuge is to switch to standby mode (1 min to 60 min).

6.2 Key lock

When the key lock has been enabled, the centrifugation time, the temperature, the *g*-force (rcf) and/or RPM, the acceleration ramp/braking ramp and the status of the At set rpm function cannot be changed accidentally.

1. To enable the key lock, press the **menu/enter** key. Use the menu arrow keys to select *Key lock*. Confirm with the **menu/enter** key.
2. Use the menu arrow keys to select *On*. Confirm with the **menu/enter** key.
A tick appears in front of the selected setting. The setting takes effect immediately.
3. To exit the menu, press the left menu arrow key ◀ several times.

6.3 Display

Standard display	When the centrifuge stands still, the set values are displayed and during centrifuging the actual values of the centrifugation parameters are displayed.
Extended display	The set value row is shown on the lower edge of the display.

6.3.1 Showing the set value row

1. Press the **menu/enter** key. Use the menu arrow keys to select *Settings > Display*. Confirm with the **menu/enter** key.
2. Use the menu arrow keys to select *Extended display*. Confirm with the **menu/enter** key.
A tick appears in front of the selected setting. The setting takes effect immediately.
3. To exit the menu, press the left menu arrow key ◀ several times.

6.3.2 Setting the contrast

1. Press the **menu/enter** key. Use the menu arrow keys to select *Settings > Contrast*. Confirm with the **menu/enter** key.
2. Change parameters with the menu arrow keys ◀ or ▶.
3. Select *Save*. Confirm with the **menu/enter** key.

6.4 Speaker

6.4.1 Switching the loudspeaker on/off

1. Press the **menu/enter** key. Use the menu arrow keys to select *Settings > Alarm*. Confirm with the **menu/enter** key.
2. Use the menu arrow keys to select *On* or *Off*. Confirm with the **menu/enter** key.
A tick appears in front of the selected setting. The setting takes effect immediately.
3. To exit the menu, press the left menu arrow key ◀ several times.

6.4.2 Setting the volume

1. Press the **menu/enter** key. Use the menu arrow keys to select *Settings > Volume*. Confirm with the **menu/enter** key.
2. Change parameters with the menu arrow keys ◀ or ▶.
3. Select *Save*. Confirm with the **menu/enter** key.

6.5 Calling up device information

- ▶ Press the **menu/enter** key. Use the menu arrow keys to select *Information > Device Information*. Confirm with the **menu/enter** key.
Device name, serial number and firmware version are displayed.

6.6 Cycle counter

Each centrifugation run in which the rotor is accelerated and braked is counted as a cycle, independent of the speed and the duration of the centrifugation run.

The usual service life of a rotor is 7 years or a maximum of 100000 cycles (Tab. on p. 64). If you expect a rotor to exceed the maximum number of cycles before the end of the 7 years, use the cycle counter as an aid.

The centrifuge detects the rotor type, but not each individual rotor. The displayed number of cycles does not give reliable information on the actual service life of a rotor.

Using the cycle counter is recommendable under the following conditions:

- Only one rotor of a rotor type is used in the centrifuge. There are no rotors of the same type in one centrifuge.
- The rotor is only used in one centrifuge. It is not used in parallel in different centrifuges.

6.6.1 Notes on reaching the maximum number of cycles



CAUTION! Danger due to material fatigue.

If the service life is exceeded, it cannot be guaranteed that the material of the rotors and the accessories will withstand the stresses during centrifugation.

- ▶ Do not use any accessories which have exceeded their maximum service life.

Before the maximum number of cycles of a rotor is reached, a pop-up window will appear that the rotor must be exchanged.

At the following 3 times, a pop-up window will appear that the maximum number of cycles has been reached:

- 2000 cycles before reaching the maximum number of cycles
- 1000 cycles before reaching the maximum number of cycles
- 400 cycles before reaching the maximum number of cycles



- ▶ Confirm with the **menu/enter** key.
- ▶ Press the **start/stop** key to start the centrifugation.

If the maximum number of cycles has been reached, a warning will appear before each run.



- ▶ Confirm with the **menu/enter** key.
- ▶ Replace the rotor.

6.6.2 Resetting the number of cycles

After a rotor has reached the maximum number of cycles and has been replaced, the number of cycles must be reset for the rotor type.

1. Press the **menu/enter** key. Use the menu arrow keys to select *Information > Number of Cycles*. Confirm with the **menu/enter** key.

The display shows the rotor type, the cycles run and the maximum cycles.



2. Select a rotor with the arrow keys ▲ or ▼. Confirm with the **menu/enter** key.
3. Select *Reset* with the menu arrow keys ◀ or ▶. Confirm with the **menu/enter** key.

The display shows:

Reset cycles?

yes/no

4. Select *yes*. Confirm with the **menu/enter** key.

The number of cycles for the rotor type will be reset to 1.

6.6.3 Changing the number of cycles

The function *Number of Cycles > Change* is intended for the authorized service only.

7 Programs

7.1 Saving the program

The Centrifuge 5920 R has more than 99 programmable memory locations.

For each program, you can define the parameters centrifugation time, temperature and speed as well as separate settings for radius, acceleration ramps/braking ramps and the start of time counting (At set rpm function). With the timer function, you can delay the start time by up to 60 min, for instance, to bridge an incubation period.

Option	Value
<i>Radius [cm]</i>	Radius in [cm] The centrifuge must have detected the rotor.
<i>Accel. ramp</i>	0 to 9
<i>Braking ramp</i>	0 to 9
<i>At set rpm</i>	Off On
<i>Timer [min]</i>	1 min to 60 min

7.1.1 Creating a program

Prerequisites

- The centrifuge has detected the rotor.
- Rotor stop.

1. Press the **menu/enter** key. Use the menu arrow keys to select *Programs* > *Save program*. Confirm with the **menu/enter** key.
2. Set the centrifugation time with the **time** arrow keys.
3. Set the temperature with the **temp** arrow keys.
4. Set the speed (rpm) or the *g*-force (rcf) with the **speed** arrow keys.



Defining additional options of the program

5. Select *Options* using the right menu arrow key ►. Confirm with the **menu/enter** key.
6. Select an option, for instance, *Accel. ramp*, with the menu arrow keys ◀ or ▶.
7. Change parameters with the menu arrow keys ◀ or ▶. Confirm with the **menu/enter** key.

Programs

Centrifuge 5920 R
English (EN)

Saving the program

8. Use the menu arrow keys to select an empty program space.
9. Use the menu arrow keys to select *Save*. Confirm with the **menu/enter** key.
 - The program is saved in the program space (without a program name).
 - The display shows the message *Assign a program name?*

Allocating a program name

10. Confirm with *yes*.



11. Select letters or numbers with the menu arrow keys and confirm with the **menu/enter** key.

The program name can have a maximum of 15 characters.

To delete individual characters, select *Delete* and press the **menu/enter** key.

12. Use the menu arrow keys to select *Save*. Confirm with the **menu/enter** key.

The display shows the program with all settings.



If the message *Assign a program name?* is discarded with *no*, a name is generated from the program number, e.g. *Prog. 12*.

7.1.2 Quick save with program keys

To save the current settings quickly, you can use the program keys.

- ▶ Keep one of the program keys **prog 1** to **prog 5** pressed for 2 seconds.
 - A signal tone sounds.
 - The LED above the program key lights blue.
 - The parameters of the program are saved.



prog 1 to **prog 5** cover the program spaces 1 to 5. The programs are saved without a program name.

7.2 Loading a saved program

7.2.1 Loading program prog 1 to prog 5

1. In order to call up a program on the program spaces 1 to 5, press one of the program keys **prog 1** to **prog 5**.
 - The LED above the program key lights blue.
 - The display shows the parameters of the program.
2. Start the program: press the **start/stop** key.

7.2.2 Loading a program from the program list

Prerequisites

- The rotor which is suitable for the program is inserted.
 - The centrifuge has detected the rotor.
1. Press the **menu/enter** key. Select *Programs > Load program*. Confirm with the **menu/enter** key.
 2. Use the menu arrow keys ◀ or ▶ to select the program space. Confirm with the **menu/enter** key.
The display shows the parameters of the program.
 3. Start the program: press the **start/stop** key.

7.2.2.1 Error messages

If a run is started although the rotor is not compatible with the parameters of a program, notes on the possible causes will appear:

Speed is flashing in the display



g-force/speed is flashing in the display: *g-force/speed* of the selected program exceeds the maximum *g-force/speed* of the rotor.

- ▶ Correct the value for *g-force/speed*.

If the run is started without correcting the *g-force/speed*, the following message will appear:

rpm/rcf too high!

[START] Centrifugation at ### rpm/### rcf

◀ ▶ *Change parameters.*

- The message shows the maximum permitted *g-force/speed* of the rotor.
 - The rotor is not stopped, but it is held at a speed of 700 rpm.
 - You have 15 seconds to adopt the *g-force/speed* or to change it.
- ▶ Adopt the displayed *g-force/speed* for the run: press the **start/stop** key.
 - ▶ Change the *g-force* or speed for the run: use the arrow keys **speed** to set a different value.
If you do not adopt or change the *g-force/speed* within 15 s, the centrifuge will stop running.

Radius is flashing in the display



Radius is flashing in the display: The radius of the selected program is larger than the maximum radius of the rotor.

- ▶ Correct the value for radius.

If the run is started without correcting the radius, the following message will appear:

Hint D

Radius not permissible.

Change rotor.

7.2.3 Editing programs

1. Load the program with the program keys: *Menu > Programs > Load program*. Confirm with the **menu/enter** key.
2. Select a program with the menu arrow keys ◀ or ▶. Confirm with the **menu/enter** key.
The display shows the parameters of the program.
3. Press the **menu/enter** key. Use the menu arrow keys to select *Programs > Save program*. Confirm with the **menu/enter** key.
The next available program space is suggested.
4. Change parameters and options (see *Creating a program on p. 45*).
5. Select *Save*. Confirm with the **menu/enter** key.
The display shows the message *Keep program name?*
6. To change the program name, discard the message with *no* and change the program name.

7.3 Deleting a program

Programs 1 to 5 cannot be deleted. All parameters of these programs can be modified and overwritten.

1. To delete a program from program spaces 6 to 99: press the **menu/enter** key. Select *Programs > Delete program*. Confirm with the **menu/enter** key
2. Use the menu arrow keys ◀ or ▶ to select the program space. Confirm with the **menu/enter** key.
The display shows the message *Delete program?*
3. Select *yes*. Confirm with the **menu/enter** key.

8 Maintenance

8.1 Maintenance



WARNING! Risk of injury due to defective gas spring(s).

A defective gas spring is an insufficient support for the centrifuge lid. There is a risk of crushing fingers or limbs.

- ▶ Make sure that the centrifuge lid can be opened completely and that it will remain in this position.
- ▶ Regularly check all gas springs for their proper function.
- ▶ Have defective gas springs replaced immediately.
- ▶ Have gas springs replaced by a service technician every 2 years.

We recommend that the centrifuge with the associated rotors be checked at the latest every 12 months by Technical Service during maintenance. Observe the relevant national regulations.

8.2 Prepare cleaning/disinfection

- ▶ Clean all accessible surfaces of the device and the accessories at least weekly and when contaminated.
- ▶ Clean the rotor regularly. This way the rotor is protected and the durability is prolonged.
- ▶ Furthermore, observe the notes on decontamination (see *Decontamination before shipment on p. 54*) when the device is sent to the authorized Technical Service for repairs.

The procedure described in the following chapter applies to the cleaning as well as to the disinfection or decontamination. The table below describes the steps required on top of this:

Cleaning	Disinfecting/decontamination
<ol style="list-style-type: none"> 1. Use a mild cleaning fluid to clean the accessible surfaces of the device and the accessories. 2. Carry out the cleaning as described in the following chapter. 	<ol style="list-style-type: none"> 1. Choose the disinfection method which corresponds to the legal regulations and guidelines in place for your range of application. For example, use alcohol (ethanol, isopropanol) or alcohol-based disinfectants. 2. Carry out the disinfection or decontamination as described in the following chapter. 3. Then clean the device and the accessories.



If you have any further questions regarding the cleaning and disinfection or decontamination or regarding the cleaning fluid to be used, contact the Eppendorf AG Application Support. The contact details are provided on the back of this manual.

8.3 Cleaning/disinfection



DANGER! Electric shock as a result of penetration of liquid.

- ▶ Switch off the device and disconnect the power plug before starting cleaning or disinfection work.
 - ▶ Do not allow any liquids to penetrate the inside of the housing.
 - ▶ Do not spray clean/spray disinfect the housing.
 - ▶ Only plug the device back in if it is completely dry, both inside and outside.
-



NOTICE! Damage from the use of aggressive chemicals.

- ▶ Do not use any aggressive chemicals on the device or its accessories, such as strong and weak bases, strong acids, acetone, formaldehyde, halogenated hydrocarbons or phenol.
- ▶ If the device becomes contaminated with aggressive chemicals, clean it immediately using a mild cleaning agent.



NOTICE! Corrosion due to aggressive cleaning agents and disinfectants.

- ▶ Do not use corrosive cleaning agents, aggressive solvents or abrasive polishes.
- ▶ Do not incubate the accessories in aggressive cleaning agents or disinfectants for a longer period of time.



NOTICE! Damage from UV and other high-energy radiation.

- ▶ Do not use UV, beta, gamma, or any other high-energy radiation for disinfecting.
 - ▶ Avoid storage in areas with strong UV radiation
-



Autoclaving

Fixed-angle rotors, rotor lids and adapters can be autoclaved (121 °C, 20 min).

Rotor crosses of swing-bucket rotors cannot be autoclaved.

After a maximum of 50 autoclaving cycles, the aerosol-tight caps and, for QuickLock rotors, the seals must be replaced.

8.3.1 Cleaning and disinfecting the device

Recommended cleaning agents:

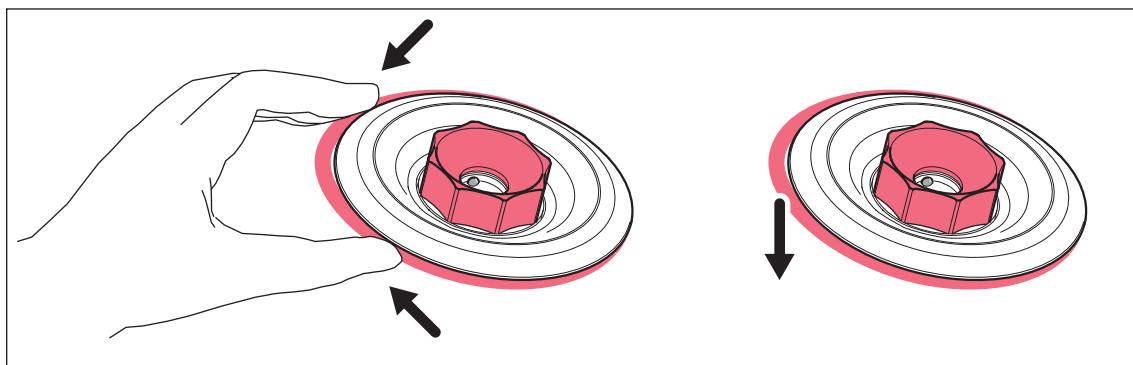
- Alcohol 70 % (ethanol, isopropanol)
- Mild neutral cleaning agent

1. Open the lid. Switch the device off using the mains switch. Disconnect the power plug from the power supply.
2. Remove the rotor.
3. Clean and disinfect all accessible surfaces of the device, including the power cable, using a damp cloth and the recommended cleaning agents.
4. Thoroughly clean the rubber seal of the rotor chamber with water.
5. Rub the dry rubber seal with glycerol or talcum powder to prevent it from becoming brittle. Other components of the device, such as the motor shaft and rotor cone, must not be lubricated.
6. Clean the motor shaft with a soft, dry and lint-free cloth. Do not lubricate the motor shaft.
7. Check the motor shaft for damage.
8. Inspect the device for corrosion and damage.
9. Leave the centrifuge lid open when the device is not being used.
10. Only connect the device to the power supply if it is fully dry inside and out.

8.3.2 Cleaning and disinfecting the rotor

1. Inspect the rotor and accessories for damage and corrosion. Do not use any damaged rotors or accessories.
2. Clean and disinfect the rotors and accessories with the recommended cleaning agents.
3. Use a bottle brush to clean and disinfect the rotor bores.
4. Clean and disinfect the rotor lid.

QuickLock rotor lids: Remove the sealing ring. Clean the sealing ring and the groove below it.



5. Rinse the rotors and accessories thoroughly with distilled water. Clean the rotor bores of fixed-angle rotors particularly thoroughly.



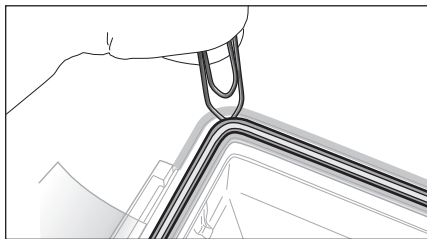
Do not immerse the rotor in liquid as liquid can get trapped inside the cavities.

6. Place rotors and accessories on a towel to dry. Place the fixed-angle rotors with the rotor bores facing down so the bores can dry.
7. Coat the sealing ring of the rotor lid with a thin layer of pivot grease and correctly reinsert it in the clean and dry groove.
8. Clean the rotor cone with a soft, dry and lint-free cloth. Do not lubricate the rotor cone.
9. Inspect the rotor cone for damage.
10. Place the dry rotor onto the motor shaft.
11. Tighten the rotor nut firmly by turning it **clockwise** with the rotor key.
12. Load the fixed-angle rotor with the cleaned adapters or the swing-bucket rotor with the cleaned buckets and adapters, if necessary.
13. Leave the rotor lid open when the rotor is not being used.

8.3.3 Changing the seal of the aerosol-tight cap

To clean the aerosol-tight cap, remove the seal of the aerosol-tight cap.

8.3.3.1 Removing the seal



1. Use a blunt lever to lift the seal out of the groove (e.g. use the round side of a paper clip). Make sure not to damage the seal with the wire ends.
2. Carefully lift the seal out of the groove.

8.3.3.2 Inserting the seal



NOTICE! Faulty sealing when the seal is handled incorrectly.

- ▶ Insert the seal evenly.
- ▶ Do not pull the seal lengthwise.

1. Check that the seal is not damaged.
Do not use any damaged, discolored or dirty seals.
2. Place the seal on the groove and slightly press it into the groove.
3. Place the cap on the bucket and close it completely.
4. Remove the cap and check the correct positioning of the seal.



If the seal is too long or too short, remove the seal from the groove. Insert the seal again.

8.4 Additional care instructions for refrigerated centrifuges

- ▶ Regularly free the rotor chamber ice formations via thawing, by leaving the centrifuge lid open or carrying out a short temperature control run at approx. 30 °C.
- ▶ To take pressure off the gas spring(s), leave the centrifuge lid open if the centrifuge is not used for a longer period.
Residual moisture can escape.
- ▶ Wipe up condensate in the rotor chamber. using a soft, absorbent cloth.
- ▶ No later than every 6 months, remove any dust deposits from the ventilation slits of the centrifuge using a brush or swab. First switch off the device and remove the power plug.

8.5 Cleaning glass breakage

When using glass tubes there is a risk of glass breakage in the rotor chamber. The resulting glass splinters are swirled around in the rotor chamber during centrifugation and have a sandblasting effect on the rotor and accessories. The smallest glass particles become lodged in the rubber parts (e.g., the motor guide, the rotor chamber seal, and the rubber mats of adapters).



NOTICE! Glass breakage in the rotor chamber

Glass tubes in the rotor chamber may break if the *g*-force is too high. Broken glass can damage the rotor, accessories and samples.

- ▶ Please note the manufacturer's information on the recommended centrifugation parameters (load and speed).
-

Effects of glass breakage in the rotor chamber:

- Fine black metal abrasion in the rotor chamber (in metal rotor chambers)
- The surfaces of the rotor chamber and accessories are scratched.
- The chemical resistance of the rotor chamber is reduced.
- Contamination of samples
- Wear on rubber parts

How to proceed in case of glass breakage

1. Remove all splinters and glass powder from the rotor chamber and accessories.
2. Thoroughly clean the rotor and rotor chamber. Thoroughly clean the bores of the fixed-angle rotors, in particular.
3. If required, replace the rubber mats and adapters to prevent any further damage.
4. Regularly check the rotor bores for deposits and damage.

8.6 Resetting the excess current switch

The 230 V and 120 V devices have built-in thermal excess-current switches which function as (all-pole) fuses. When the overload protection is actuated, these switch the power switch to OFF, but do not switch it on again automatically.

To switch on the excess current switch again, proceed as follows:

1. Switch off the centrifuge using the power switch.
2. Wait for at least 20 seconds and switch on the centrifuge again.

The excess current switch will be automatically reactivated and the centrifuge is ready for operation.

8.7 Decontamination before shipment

If you are shipping the device to the authorized Technical Service for repairs or to your authorized dealer for disposal please note the following:



WARNING! Risk to health from contaminated device

1. Follow the instructions in the decontamination certificate. You can find it as a PDF file on our website (www.eppendorf.com/decontamination).
 2. Decontaminate all the parts you would like to dispatch.
 3. Include the fully completed decontamination certificate in the package.
-

9 Troubleshooting

If you cannot remedy an error with the recommended measures, please contact your local Eppendorf partner. The contact addresses can be found on the Internet at www.eppendorf.com.

9.1 General errors

Problem	Cause	Solution
No display.	No mains/power connection.	▶ Check the mains connection.
	Power failure.	▶ Check the fuse of the device. ▶ Check the mains fuse of the laboratory.
The centrifuge lid cannot be opened.	Rotor is still running.	▶ Wait for rotor to stop.
	Power failure.	1. Check the fuse of the device. 2. Check the mains fuse of the laboratory. 3. Actuate emergency release.
The centrifuge cannot be started.	Centrifuge lid is not closed.	▶ Close the centrifuge lid.
Centrifuge shakes when it starts up.	Rotor is loaded asymmetrically.	1. Stop the centrifuge and load the rotor symmetrically. 2. Re-start the centrifuge.
Centrifuge brakes during short spin centrifugation even though the short key is pressed.	The short key was released briefly more than twice (protective function for the drive).	▶ Press and hold the short key during a short spin centrifugation.
Temperature display flashes.	Temperature deviation from set value: $> \pm 3$ °C.	▶ Check the settings. ▶ Wait until the set temperature has been reached. ▶ Check unhindered air circulation through the air slots. ▶ Thaw ice or switch off device and allow it to cool down.

9.2 Error messages

If an error message appears, proceed as follows:

1. Remedy the fault as described in the "Remedy" column.
2. To clear the error message from the display, press the **open** key.
3. If necessary, repeat centrifugation.

Problem	Cause	Solution
<i>Hint A</i> <i>Lid latch</i>	Centrifuge lid will not lock.	▶ Try again to close centrifuge lid.
<i>Hint B</i> <i>Imbalance</i>	Rotor is loaded asymmetrically.	▶ Load the rotor symmetrically and balance it. ▶ Swing-bucket rotor: Apply a thin layer of pivot grease to the pegs.
<i>Hint C</i> <i>Rotor detection</i>	Speed (rpm) or <i>g</i> -force (rcf) is higher than the maximum speed (rpm) or the <i>g</i> -force (rcf) of the rotor.	1. Correct rpm/rcf. 2. Repeat the run.
<i>Hint D</i> <i>Rotor detection</i>	<ul style="list-style-type: none"> • The radius of the selected program is larger than the maximum radius of the rotor. • The rotor is not compatible with the program. 	▶ Change the radius. ▶ Replace the rotor.

Problem	Cause	Solution
<i>ERROR 1</i> <i>Rotor detection</i>	Rotor not detected.	▶ Check rotor. ▶ If this error message appears again, test the rotor detection with a different rotor.
<i>ERROR 2</i> <i>Electronics fault</i>	Electronics fault.	1. Switch off centrifuge and wait for 20 s. 2. Switch on the centrifuge.
<i>ERROR 3</i> <i>Speed check</i>	Error in speed measuring system.	▶ Insert and tighten rotor. ▶ Wait for the displayed time. ▶ Let the centrifuge stand while switched on until the error message disappears.
<i>ERROR 5</i> <i>Electronics fault</i>	Prohibited opening of lid during a run or lid switch is defective.	1. Wait for rotor to stop. 2. Open and close again the lid of the device. 3. Repeat the run.

Problem	Cause	Solution
<i>ERROR 6</i> <i>Drive fault</i>	<ul style="list-style-type: none"> • Error in the drive electronics. • Drive overheated. 	<p>▶ Repeat the run.</p> <p>If the error message appears again:</p> <ol style="list-style-type: none"> 1. Switch off centrifuge and wait for 20 s. 2. Switch on the centrifuge. <p>If the error message appears again:</p> <p>▶ Let the drive cool down for at least 15 min.</p>
	<ul style="list-style-type: none"> • Emergency release was actuated during a run. 	<p>▶ Wait for rotor to stop.</p>
<i>ERROR 7</i> <i>Speed check</i>	Deviation in the speed control.	<ol style="list-style-type: none"> 1. Wait for rotor to stop. 2. Tighten the rotor.
<i>ERROR 9 – ERROR 14</i>	Electronics fault.	<ol style="list-style-type: none"> 1. Switch off centrifuge and wait for 20 s. 2. Switch on the centrifuge.
<i>ERROR 16 – ERROR 17</i> <i>Electronics fault</i>	Electronics fault.	<ol style="list-style-type: none"> 1. Switch off centrifuge and wait for 20 s. 2. Switch on the centrifuge.
<i>ERROR 18, ERROR 20</i> <i>Room Temp. of rotor chamber</i>	Deviation from target temperature in the rotor chamber.	<p>▶ Allow the device to cool down and repeat cycle.</p>
<i>ERROR 22</i> <i>Electronics fault</i>	Electronics fault.	<ol style="list-style-type: none"> 1. Switch off centrifuge and wait for 20 s. 2. Switch on the centrifuge.
<i>ERROR 25</i> <i>Power failure</i>	Mains/power failure during a run.	<p>▶ Check the power supply.</p>
<i>ERROR 26 – ERROR 27</i> <i>Electronics fault</i>	Electronics fault.	<ol style="list-style-type: none"> 1. Switch off centrifuge and wait for 20 s. 2. Switch on the centrifuge.
<i>ERROR 28</i> <i>Electronics fault</i>	Electronics fault.	<p>▶ Press the open key.</p>
<i>ERROR 30</i> <i>Lid latch</i>	Centrifuge lid will not lock.	<p>▶ Try again to close centrifuge lid.</p>
	Centrifuge lid cannot be released.	<p>▶ Switch the device off and back on.</p> <p>If the error occurs again:</p> <ol style="list-style-type: none"> 1. Switch off the device. 2. Activate the emergency lid release.
	Centrifuge lid has not been opened wide enough.	<p>▶ Open the centrifuge lid wider by hand.</p>

9.3 Emergency release

If the centrifuge lid cannot be opened, you can activate the emergency release manually.



WARNING! Risk of injury from rotating rotor.

If the emergency release of the lid is operated, the rotor may continue rotating for several minutes.

- ▶ Wait for the rotor to stop before activating the emergency release.
 - ▶ To check, look through the monitoring glass in the centrifuge lid.
-

Use the rotor key delivered with the Centrifuge 5920 R for the emergency release. Carry out the following steps on both the left side and right side of the centrifuge.

1. Pull out the mains/power plug and wait for the rotor to stop.
2. Insert the rotor key into the hexagonal opening on one side of the centrifuge until noticeable resistance can be felt.
3. Slightly press and turn the rotor key **counterclockwise**.
4. Insert the rotor key into the hexagonal opening on the opposite side of the centrifuge until noticeable resistance can be felt.
5. Slightly press and turn the rotor key **counterclockwise**.
This will release the centrifuge lid.
6. Open the centrifuge lid.

10 Transport, storage and disposal

10.1 Transport

- ▶ Remove the rotor from the centrifuge before transport.
- ▶ Use the original packing for transport.

	Air temperature	Relative humidity	Atmospheric pressure
General transport	-25 °C – 60 °C	10 % – 75 %	30 kPa – 106 kPa
Air freight	-20 °C – 55 °C	10 % – 75 %	30 kPa – 106 kPa

10.2 Storage

	Air temperature	Relative humidity	Atmospheric pressure
In transport packing	-25 °C – 55 °C	10 % – 75 %	70 kPa – 106 kPa
Without transport packing	-5 °C – 45 °C	10 % – 75 %	70 kPa – 106 kPa

10.3 Disposal

In case the product is to be disposed of, the relevant legal regulations are to be observed.

Information on the disposal of electrical and electronic devices in the European Community:

Within the European Community, the disposal of electrical devices is regulated by national regulations based on EU Directive 2012/19/EU pertaining to waste electrical and electronic equipment (WEEE).

According to these regulations, any devices supplied after August 13, 2005, in the business-to-business sphere, to which this product is assigned, may no longer be disposed of in municipal or domestic waste. To document this, they have been marked with the following identification:



Because disposal regulations may differ from one country to another within the EU, please contact your supplier if necessary.

Transport, storage and disposal

Centrifuge 5920 R

English (EN)

11 Technical data

11.1 Power supply

Centrifuge 5920 R

Mains/power connection	230 V \pm 10 %, 50 Hz – 60 Hz 120 V \pm 10 %, 50 Hz – 60 Hz
Current consumption	12.0 A (230 V) 12.0 A (120 V)
Power consumption	Maximum 1650 W (230 V) Maximum 1440 W (120 V)
EMC: noise emission (radio interference)	EN 61326 – Class A (230 V) FCC15 - Class A (120 V/100 V)
EMC: noise immunity	EN 61326
Overvoltage category	II
Fuses	Excess current switch 16 A
Degree of pollution	2

11.2 Weight/dimensions

Dimensions	Width: 73.7 cm (29.02 in) Depth: 70.7 cm (27.83 in) Height: 40.3 cm (15.87 in)
Weight without rotor	139.0 kg (306.44 lb)

11.3 Noise level

The noise level was measured according to (DIN EN ISO 3745) frontally in a sound measuring room with accuracy class 1 at a distance of 1 m from the device and at lab bench height.

	Swing-bucket rotor	Fixed-angle rotor
Noise level at maximum rotor speed	< 60 dB(A)	< 67 dB(A)

11.4 Ambient conditions

Ambience	Only for use indoors.
Ambient temperature	10 °C – 40 °C
Relative humidity	10 % – 75 %, non-condensing.
Atmospheric pressure	79.5 kPa – 106 kPa

11.5 Application parameters

Cycle time	10 s – 99:59 h, infinite (∞), <ul style="list-style-type: none"> • 10 s – 2 min: can be set in increments of 10 s • 2 min – 10 min: can be set in increments of 30 s • 10 min – 99:59 h: can be set in increments of 1 min
Temperature	-11 °C – 40 °C
Relative centrifugal force	$1 \times g$ – $22132 \times g$ <ul style="list-style-type: none"> • $1 \times g$ – $3000 \times g$: can be set in increments of $10 \times g$ • $3000 \times g$ – $22132 \times g$: can be set in increments of $100 \times g$
Speed	10 rpm – 14000 rpm <ul style="list-style-type: none"> • 10 rpm – 5000 rpm: can be set in increments of 10 rpm • 5000 rpm – 14000 rpm: can be set in increments of 100 rpm
Maximum load	Fixed-angle rotor: 6 × 85 mL Swing-bucket rotors: 4 × 1000 mL
Maximum kinetic energy	56000 Nm
Permissible density of the material for centrifuging (at maximum g -force (rcf) or speed (rpm) and maximum load)	1.2 g/mL
Inspection obligation in Germany	yes

11.6 Acceleration and deceleration times

The following table shows the approximate acceleration and deceleration times according to DIN 58970 for the rotors of the Centrifuge 5920 R. The details were determined with the rotor at maximum load (for swing-bucket rotors with round bucket). Fluctuations may occur depending on the condition of the device and the load.

Level 9 means "strongest braking", level 0 means "free deceleration".

Rotor		0	1	2	3	4	5	6	7	8	9
S-4x1000	Acceleration time	445 s	281 s	191 s	127 s	92 s	69 s	61 s	55 s	49 s	45 s
	Deceleration time	1000 s	440 s	240 s	155 s	110 s	78 s	68 s	57 s	48 s	40 s
	Tolerance	–	–	±5 %*							
S-4x750	Acceleration time	410 s	261 s	187 s	123 s	92 s	72 s	59 s	51 s	46 s	42 s
	Deceleration time	1049 s	416 s	216 s	154 s	109 s	84 s	64 s	54 s	46 s	37 s
	Tolerance	–	–	±5 %*							
F-6x85	Acceleration time	395 s	269 s	185 s	126 s	90 s	65 s	55 s	45 s	39 s	33 s
	Deceleration time	1057 s	371 s	235 s	169 s	118 s	85 s	69 s	56 s	47 s	35 s
	Tolerance	–	–	±5 %*							
FA-6x50	Acceleration time	319 s	212 s	148 s	101 s	73 s	53 s	46 s	38 s	34 s	28 s
	Deceleration time	857 s	334 s	214 s	153 s	107 s	77 s	66 s	51 s	43 s	32 s
	Tolerance	–	–	±5 %*							
FA-48x2	Acceleration time	254 s	171 s	120 s	81 s	60 s	44 s	38 s	32 s	28 s	23 s
	Deceleration time	680 s	231 s	152 s	109 s	80 s	57 s	47 s	40 s	34 s	26 s
	Tolerance	–	–	±5 %*							
FA-20x5	Acceleration time	307 s	208 s	145 s	99 s	72 s	52 s	45 s	37 s	32 s	26 s
	Deceleration time	815 s	292 s	193 s	136 s	97 s	71 s	59 s	47 s	40 s	31 s
	Tolerance	–	–	±5 %*							

* 5 s minimum

11.7 Service life for accessories



CAUTION! Danger due to material fatigue.

If the service life is exceeded, it cannot be guaranteed that the material of the rotors and the accessories will withstand the stresses during centrifugation.

- ▶ Do not use any accessories which have exceeded their maximum service life.

The following requirements must be met in order to use rotors, rotor lids and accessories:

- Correct use
- Recommended maintenance
- Undamaged condition

The service life of rotors and accessories is indicated by two values:

- service life in years
- maximum number of cycles

Eppendorf states the maximum service life of the rotors and accessories both in years and in the maximum number of cycles. The decisive factor for the service life is which case occurs first, usually this is the number of years in operation.

Each centrifugation run in which the rotor is accelerated and braked is counted as a cycle, independent of the speed and the duration of the centrifugation run.

Rotor	Maximum service life after initial setup	
S-4x1000	100000 cycles	7 years
S-4x1000 with High-Capacity Bucket	75000 Zyklen	7 years
S-4x750	100000 cycles	7 years
F-6x85	100000 cycles	7 years
FA-6x50	100000 cycles	7 years
FA-48x2	100000 cycles	7 years
FA-20x5	100000 cycles	7 years

Accessories	Maximum service life after initial setup	
Rotor lid of polycarbonate (PC), polypropylene (PP) or polyetherimide (PEI)	–	3 years
Aerosol-tight rotor lid, without replaceable seals	50 autoclaving cycles	–
QuickLock rotor lid		3 years
Seals of the QuickLock rotor lids	50 autoclaving cycles	–
Caps of polycarbonate (PC), polypropylene (PP) or polyetherimide (PEI)	50 autoclaving cycles	3 years
Adapter	–	1 year

The date of manufacture is stamped on the rotors in the format *03/10* (= March 2010) or on the inside of the plastic rotor lids and caps in the form of a clock 🕒. This is for information only and does not have any reference to the service life.

Measures to ensure aerosol tightness

- Replace aerosol-tight rotor lids and aerosol-tight caps after 50 autoclaving cycles.
- Replace the seal of QuickLock rotor lids after 50 autoclaving cycles.



QuickLock lids resp. caps have replaceable gaskets. If the gaskets are replaced after 50 autoclaving cycles, QuickLock lids and/or aerosol-tight caps have a service life of 3 years.

- ▶ To ensure aerosol tightness, replace the gasket of the QuickLock rotor lids or caps after 50 autoclaving cycles.

12 Rotors for Centrifuge 5920 R



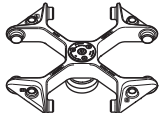


Eppendorf centrifuges may only be operated with rotors that are intended for use with the corresponding centrifuge.


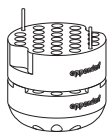

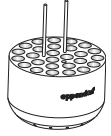

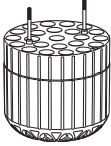
- ▶ Only use rotors which are marked with the name of the centrifuge (e.g., 5920 R).

Please note the manufacturer's information on the centrifugation resistance of the sample tubes used (maximum *g*-force).

12.1 Rotor S-4x1000



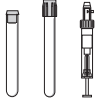
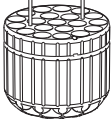



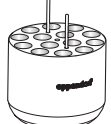





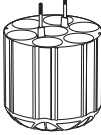
12.1.1 Swing-bucket rotor S-4x1000 with 4 aerosol-tight round buckets 1000 mL


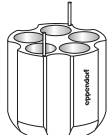




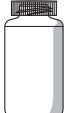





			Max. <i>g</i> -force: 3428 × <i>g</i>
			Max. speed: 3700 rpm
Rotor S-4x1000	Round bucket 1000 mL	Aerosol-tight cap	Max. load per bucket (adapter, tube and contents): 1340 g

Tube	Tube Capacity Number per adapter/rotor	Adapter Order no. (international)	Bottom shape Tube diameter Max. tube length with/without cap	Max. <i>g</i> -force Max. speed Radius
	Tube 1.5 mL/2 mL 50/200	 5825 740.009	open Ø 11 mm 39 mm	Top: 2648 × <i>g</i> Bottom: 3352 × <i>g</i> 3700 rpm Top: 17.3 cm Bottom: 21,9 cm
	Round-bottom tube Ø 12 mm × 75 mm 27/108	 5825 747.003	round Ø 12 mm 108 mm/115 mm	3229 × <i>g</i> 3700 rpm 21.1 cm
	Round-bottom tube 4 mL – 8 mL (Ø 13 mm × 75 mm – 100 mm) 23/92	 5825 738.004	round Ø 13 mm 113 mm/121 mm	3214 × <i>g</i> 3700 rpm 21,0 cm

Rotors for Centrifuge 5920 R




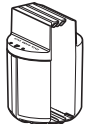
Centrifuge 5920 R
English (EN)

Tube	Tube Capacity Number per adapter/rotor	Adapter Order no. (international)	Bottom shape Tube diameter Max. tube length with/without cap	Max. <i>g</i> -force Max. speed Radius
	Eppendorf Tubes 5 mL 14/56	 5825 734.009 (without upper part)	conical Ø 17 mm 150 mm/161 mm	3428 × <i>g</i> 3700 rpm 22,4 cm
	Round-bottom tube 7.5 mL – 12 mL (Ø 16 mm × 75 mm – 100 mm) 20/80	 5825 736.001	round Ø 16 mm 120 mm/125 mm	3229 × <i>g</i> 3700 rpm 21.1 cm
	Tube 9 mL (Ø 17.5 mm × 100 mm) 20/80	 5825 743.008	round Ø 17,5 mm 112 mm/117 mm	3214 × <i>g</i> 3700 rpm 21.0 cm
	Round-bottom tube 14 mL 14/56	 5825 748.000	round Ø 17.5 mm 112 mm/117 mm	3214 × <i>g</i> 3700 rpm 21.0 cm
	Conical tube 15 mL 14/56	 5825 734.009	conical Ø 17 mm 150 mm/161 mm	3428 × <i>g</i> 3700 rpm 22,4 cm
	Universal tube 30 mL 5825 755.006	 5825 755.006	conical Ø 25 mm 139 mm/144 mm	3245 × <i>g</i> 3700 rpm 21.2 cm
	Conical tube 50 mL 7/28	 5825 733.002	conical Ø 29 mm 150 mm/156 mm	3413 × <i>g</i> 3700 rpm 22.3 cm

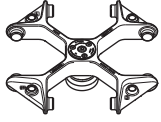
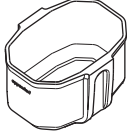
Tube	Tube Capacity Number per adapter/rotor	Adapter Order no. (international)	Bottom shape Tube diameter Max. tube length with/without cap	Max. g-force Max. speed Radius
	Conical tube (skirted) 50 mL 5/20	 5825 732.006	conical Ø 29 mm 147 mm/151 mm	3199 × g 3700 rpm 20.9 cm
	Wide-neck bottle/ conical tube 175 mL – 250 mL 250 mL Corning 1/4	 5825 741.005	flat For conical tubes, additionally insert the adapter of the manufacturer. Ø 62 mm 156 mm/176 mm	3275 × g 3700 rpm 21,4 cm
	Conical tube 500 mL Corning 1/4	 5825 745.000	conical Ø 96 mm 167 mm/167 mm	3336 × g 3700 rpm 21.8 cm
	Wide-neck bottle 500 mL 1/4	 5920 703.005	flat 69,5 mm 183 mm/183 mm	3382 × g 3700 rpm 22.1 cm
	TPP bioreactor 600 mL 1/4	 5920 701.002	conical Ø 98 mm 181 mm/181 mm	3428 × g 3700 rpm 22,4 mm
	Wide-neck bottle 750 mL 1/4	 5825 744.004	flat Ø 102 mm 181 mm/181 mm	3306 × g 3700 rpm 21,6 cm


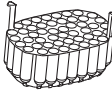

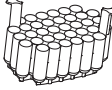

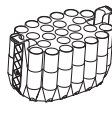

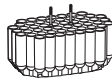

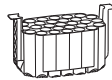

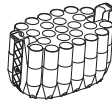
Rotors for Centrifuge 5920 R

Centrifuge 5920 R
English (EN)

Tube	Tube Capacity Number per adapter/rotor	Adapter Order no. (international)	Bottom shape Tube diameter Max. tube length with/without cap	Max. <i>g</i> -force Max. speed Radius
	Wide-neck bottle Nalgene: 3120 1010, 3122 1010 1000 mL 1/4	 5920 700.006	flat Ø 98 mm (Do not use aerosol-tight cap.)/169 mm	3336 × <i>g</i> 3700 rpm 21.8 cm
	TaqMan Array Microfluidic Card 3/12	 5825 759.001		3199 × <i>g</i> 3700 rpm 20.9 cm


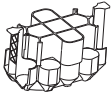


12.1.2 Swing-bucket rotor S-4x1000 with 4 High-Capacity Buckets

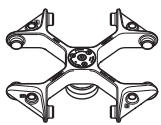
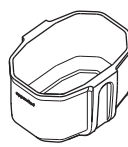

		Max. <i>g</i> -force: 3153 × <i>g</i>
		Max. speed: 3700 rpm
Rotor S-4x1000	High-Capacity Bucket	Max. load per bucket (adapter, tube and contents): 1150 g

Tube	Tube Capacity Tubes per adapter/ rotor	Adapter Order no. (international)	Bottom shape Tube diameter Max. tube length	Max. <i>g</i> -force Max. speed Radius
	Round-bottom tube 4 mL – 8 mL (Ø 13 mm × 75 mm – 100 mm) 49/196	 5920 718.002	round Ø 13 mm 107 mm	3122 × <i>g</i> 3700 rpm 20.4 cm
	Round-bottom tube 7.5 mL – 12 mL (Ø 16 mm × 75 mm – 100 mm) 36/44	 5920 720.007	round Ø 16 mm 107 mm	3046 × <i>g</i> 3700 rpm 19.9 cm
	Eppendorf Tubes 5 mL 25/100	 5920 716.000 (without upper part)	conical Ø 17 mm 57 mm	3138 × <i>g</i> 3700 rpm 20,5 cm
	Round-bottom tube Ø 12 mm × 75 mm 52/208	 5920 724.002	round Ø 12 mm 85 mm	3122 × <i>g</i> 3700 rpm 20.4 cm
	Round-bottom tube 14 mL 29/116	 5920 722.000	round Ø 17,5 mm 14 mm	3122 × <i>g</i> 3700 rpm 20.4 cm
	Conical tube 15 mL 27/108	 5920 716.000	conical Ø 17 mm 121 mm	3138 × <i>g</i> 3700 rpm 20,5 cm

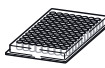

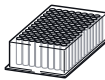

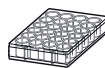

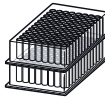


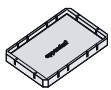
Rotors for Centrifuge 5920 R

Centrifuge 5920 R
English (EN)

Tube	Tube Capacity Tubes per adapter/ rotor	Adapter Order no. (international)	Bottom shape Tube diameter Max. tube length	Max. <i>g</i> -force Max. speed Radius
	Conical tube 50 mL 13/52	 5920 715.003	conical Ø 29 mm 116 mm	3 153 × <i>g</i> 3700 rpm 20,6 cm
	Wide-neck bottle/ conical tube 175 mL – 250 mL 2/8	 5920 717.006	flat Ø 60 mm 148 mm	3 061 × <i>g</i> 3700 rpm 20,0 cm

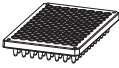
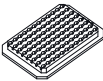
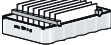

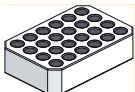

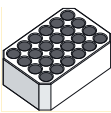
			Max. <i>g</i> -force: 2832 × <i>g</i>
			Max. speed: 3700 rpm
Rotor S-4x1000	High-Capacity Bucket with plate carrier		Max. load per bucket (adapter, tube and contents): 1150 g

Always use the High-Capacity Bucket with plate carrier for centrifugation of the following plates and tubes. Use plate carrier and adapter if necessary.

Plate/tube	Plate Capacity Number per adapter/rotor	Adapter Order no. (international)	Bottom shape Max. loading height	Max. <i>g</i> -force Max. speed Radius
	Microplate 96/384 wells 6/24	 5920 729.004	flat 88 mm	2832 × <i>g</i> 3700 rpm 18.5 cm
	Deepwell plate 96 wells 2/8	 5920 729.004	flat 88 mm	2832 × <i>g</i> 3700 rpm 18.5 cm
	Cell culture plate 1/4	 5920 729.004	flat 88 mm	2832 × <i>g</i> 3700 rpm 18.5 cm
	Kit 1/4	 5920 729.004	flat 88 mm	2832 × <i>g</i> 3700 rpm 18.5 cm
	PCR plate 384 wells 1/4	Plate carrier +  5825 713.001	flat 88 mm	2694 × <i>g</i> 3700 rpm 17,6 cm


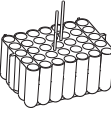

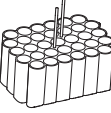





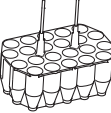
Rotors for Centrifuge 5920 R

Centrifuge 5920 R
English (EN)

Plate/tube	Plate Capacity Number per adapter/rotor	Adapter Order no. (international)	Bottom shape Max. loading height	Max. <i>g</i> -force Max. speed Radius
	PCR plate 96 wells 1/4	Plate carrier +  5825 711.009	conical 88 mm	2357 × <i>g</i> 3700 rpm 17.8 cm
Slides	CombiSlide 12 slides 12/48	Plate carrier +  5825 706.005	flat 88 mm	2770 × <i>g</i> 3700 rpm 18,1 cm
	IsoRack 24 × 0,5 mL micro test tubes 1/4	Plate carrier +  5825 708.008	open Ø 6 mm 88 mm	2724 × <i>g</i> 3700 rpm 17.8 cm
	IsoRack 24 × 1.5/2 mL micro test tubes 1/4	Plate carrier +  5825 709.004	open Ø 11 mm 88 mm	2663 × <i>g</i> 3700 rpm 17.4 cm






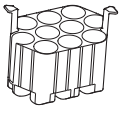

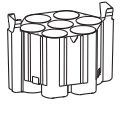
12.1.3 Swing-bucket rotor S-4x1000 with 4 aerosol-tight plates/tube buckets

			Max. <i>g</i> -force: 3076 × <i>g</i>
			Max. speed: 3700 rpm
Rotor S-4x1000	Plate/tube bucket	Aerosol-tight cap	Max. load per bucket (adapter, tube and contents): 970 g

Tube	Tube Capacity Tubes per adapter/ rotor	Adapter Order no. (international)	Bottom shape Tube diameter Max. tube length with/without cap	Max. <i>g</i>-force Max. speed Radius
	Round-bottom tube 4 mL – 8 mL (Ø 13 mm × 75 mm – 100 mm 35/140	 5920 706.004	round Ø 13 mm 108 mm/109 mm	3076 × <i>g</i> 3700 rpm 20.1 cm
	Round-bottom tube 7.5 mL – 12 mL 33/132	 5920 707.000	round Ø 16 mm 109 mm/109 mm	3061 × <i>g</i> 3700 rpm 20,0 cm
	Tube 9 mL (Ø 17.5 mm × 75 mm) 28/112	 5920 708.007	round Ø 17,5 mm 109 mm/109 mm	3061 × <i>g</i> 3700 rpm 20,0 cm
	Tube 9 mL (Ø 17.5 mm × 100 mm) 21/84	 5920 708.007 Do not use the outer bores.	round Ø 17,5 mm 109 mm/109 mm	3061 × <i>g</i> 3700 rpm 20,0 cm
	Eppendorf Tubes 5 mL 22/88	 5920 710.001 without upper part	conical Ø 17 mm 65 mm/65 mm	3076 × <i>g</i> 3700 rpm 20.1 cm

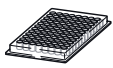

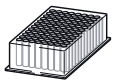

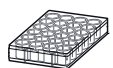




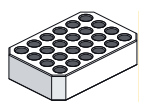
Rotors for Centrifuge 5920 R

Centrifuge 5920 R
English (EN)

Tube	Tube Capacity Tubes per adapter/ rotor	Adapter Order no. (international)	Bottom shape Tube diameter Max. tube length with/without cap	Max. <i>g</i> -force Max. speed Radius
	Conical tube 15 mL 22/88	 5920 710.001	conical Ø 17 mm (Do not use aerosol-tight cap.)/ 121 mm	3076 × <i>g</i> 3700 rpm 20.1 cm
	Conical tube 15 mL 16/64	 5920 712.004	conical Ø 17 mm 121 mm/123 mm	3076 × <i>g</i> 3700 rpm 20.1 cm
	Conical tube 50 mL 10/40	 5920 709.003	conical Ø 29 mm (Do not use aerosol-tight cap.)/ 121 mm	3076 × <i>g</i> 3700 rpm 20.1 cm
	Conical tube 50 mL 7/28	 5920 711.008	conical Ø 29 mm 121 mm/121 mm	3076 × <i>g</i> 3700 rpm 20.1 cm

			Max. <i>g</i> -force: 3076 × <i>g</i>
			Max. speed: 3700 rpm
Rotor S-4x1000	Plate/Tube Bucket with plate carrier	Aerosol-tight cap	Max. load per bucket (adapter, tube and contents): 970 g


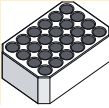

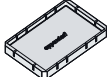
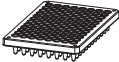

Always use the Plate/Tube Bucket with plate carrier for the centrifugation of the following plates and tubes. Use plate carrier and adapter if necessary.

Plate	Plate Capacity Number per adapter/rotor	Adapter Order no. (international)	Bottom shape Max. loading height	Max. <i>g</i>-force Max. speed Radius
	Microplate 96/384 wells 10/40	 5920 705.008	flat 91 mm/104 mm	3030 × <i>g</i> 3700 rpm 19,8 cm
	Deepwell plate 96 wells 2/8	 5920 705.008	flat 91 mm/104 mm	3030 × <i>g</i> 3700 rpm 19,8 cm
	Cell culture plate 2/8	 5920 705.008	flat 91 mm/104 mm	3030 × <i>g</i> 3700 rpm 19,8 cm
	Kit 1/4	 5920 705.008	flat 91 mm/104 mm	3030 × <i>g</i> 3700 rpm 19,8 cm
	IsoRack 24 × 0.5 mL micro test tubes 1/4	Plate carrier +  5825 708.008	open Ø 6 mm 47 mm/60 mm	3015 × <i>g</i> 3700 rpm 19,1 cm

Rotors for Centrifuge 5920 R

Centrifuge 5920 R


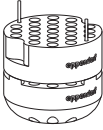

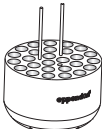

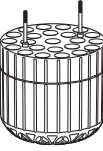



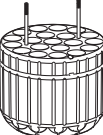
English (EN)

Plate	Plate Capacity Number per adapter/rotor	Adapter Order no. (international)	Bottom shape Max. loading height	Max. <i>g</i> -force Max. speed Radius
	IsoRack 24 × 1.5/2 mL micro test tubes 1/4	Plate carrier +  5825 709.004	open Ø 11 mm 47 mm/60 mm	2862 × <i>g</i> 3700 rpm 18.7 cm
	PCR plate 384 wells 1/4	Plate carrier +  5825 713.001	flat 91 mm/104 mm	2893 × <i>g</i> 3700 rpm 18,9 cm
	PCR plate 96 wells 1/4	Plate carrier +  5825 711.009	conical 91 mm/104 mm	2939 × <i>g</i> 3700 rpm 19.2 cm
Slides	CombiSlide 12 slides 12/48	Plate carrier +  5825 706.005	flat 47 mm/60 mm	2985 × <i>g</i> 3700 rpm 19,5 cm

12.2 Rotor S-4 x750


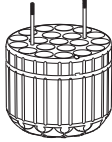



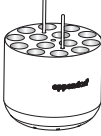





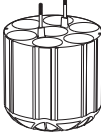
12.2.1 Swing-bucket rotor S-4x750 with 4 aerosol-tight round buckets 750 mL


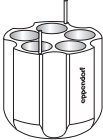






			Max. <i>g</i> -force: 4791 × <i>g</i>
			Max. speed: 4700 rpm
Rotor S-4 x750	Round bucket 750 mL	Aerosol-tight cap	Max. load per bucket (adapter, tube and contents): 1000 g

Tube	Tube Capacity Tubes per adapter/ rotor	Adapter Order no. (international)	Bottom shape Tube diameter Max. tube length with/without cap	Max. <i>g</i> -force Max. speed Radius
	Micro test tube 1.5 mL/2 mL 50/200	 5825 740.009	open Ø 11 mm 39 mm	Top: 3655 × <i>g</i> Bottom: 4791 × <i>g</i> 4700 rpm Top: 14.8 cm Bottom: 19.4 cm
	Round-bottom tube 12 mm × 75 mm 27/108	 5825 747.003	round Ø 12 mm 113 mm/120 mm	4593 × <i>g</i> 4700 rpm 18.6 cm
	Round-bottom tube 4 mL – 8 mL (Ø 13 mm × 75 mm – 100 mm) 23/92	 5825 738.004	round Ø 13 mm 113 mm/121 mm	4569 × <i>g</i> 4700 rpm 18.5 cm
	Eppendorf Tubes 5 mL 14/56	 5825 734.009 (without upper part)	conical Ø 17 mm 65 mm	4643 × <i>g</i> 4700 rpm 18,8 cm
	Round-bottom tube 7.5 mL – 12 mL (Ø 16 mm × 75 mm – 100 mm) 20/80	 5825 736.001	round Ø 16 mm 120 mm/125 mm	4594 × <i>g</i> 4700 rpm 18.6 cm

Rotors for Centrifuge 5920 R

Centrifuge 5920 R
English (EN)

Tube	Tube Capacity Tubes per adapter/ rotor	Adapter Order no. (international)	Bottom shape Tube diameter Max. tube length with/without cap	Max. <i>g</i> -force Max. speed Radius
	Round-bottom tube 8 mL – 16 mL 7/28 (load inner bore only (Fig. 5-5 on p. 29))	 5825 736.001	round Ø 16 mm (Do not use aerosol-tight cap.)/ 125 mm	4594 × <i>g</i> 4700 rpm 18.6 cm
	Tube 9 mL (Ø 17.5 mm × 100 mm) 20/80	 5825 743.008	round Ø 17,5 mm 112 mm/117 mm	4569 × <i>g</i> 4700 rpm 18.5 cm
	Round-bottom tube 14 mL 14/56	 5825 748.000	round Ø 17,5 mm 106 mm	4569 × <i>g</i> 4700 rpm 18.5 cm
	Conical tube 15 mL 14/56	 5825 734.009	conical Ø 17 mm × 104 mm 120 mm/125 mm	4643 × <i>g</i> 4700 rpm 18,8 cm
	Universal tube 30 mL 5825 755.006	 5825 755.006	conical Ø 25 mm 114 mm/119 mm	4470 × <i>g</i> 4700 rpm 18.1 cm
	Conical tube 50 mL 7/28	 5825 733.002	conical Ø 29 mm 116 mm/122 mm	4618 × <i>g</i> 4700 rpm 18.7 cm

Tube	Tube Capacity Tubes per adapter/ rotor	Adapter Order no. (international)	Bottom shape Tube diameter Max. tube length with/without cap	Max. <i>g</i> -force Max. speed Radius
	Conical tube (skirted) 50 mL 5/20	 5825 732.006	conical Ø 29 mm 116 mm/122 mm	4371 × <i>g</i> 4700 rpm 17,7 cm
	Wide-neck bottle/ conical tube 175 mL – 250 mL 1/4	 5825 741.005	flat Ø 62 mm 125 mm/145 mm	4519 × <i>g</i> 4700 rpm 18,3 cm
	Conical tube 500 mL Corning 1/4	 5825 745.000	conical Ø 96 mm (Do not use aerosol-tight cap.)/ 147 mm	4594 × <i>g</i> 4700 rpm 18.6 cm
	Wide-neck bottle 750 mL 1/4	 5825 744.004	flat Ø 102 mm 150 mm/150 mm	4569 × <i>g</i> 4700 rpm 18.5 cm

Rotors for Centrifuge 5920 R

Centrifuge 5920 R
English (EN)

12.2.2 Swing-bucket rotor S-4x750 with 4 plate buckets

Always use plates together with plate carrier.

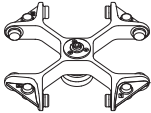


			Max. <i>g</i> -force: 3976 × <i>g</i>
			Max. speed: 4700 rpm
Rotor S-4 x750	Plate bucket (always use with plate carrier)	Aerosol-tight cap	Max. load per bucket (adapter, plate and contents): 450 g

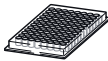

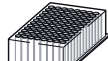

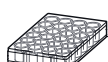

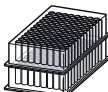


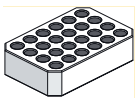

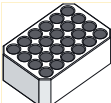

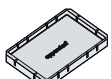

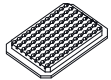
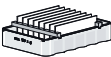
Plate	Plate Capacity Number per adapter/rotor	Adapter Order no. (international)	Bottom shape Max. loading height	Max. <i>g</i> -force Max. speed Radius
	Microplate 96/384 wells 4/16	 5820 756.004	flat 47 mm/64 mm	3976 × <i>g</i> 4700 rpm 16,1 cm
	Deepwell plate 96 wells 1/4	 5820 756.004	flat 47 mm/64 mm	3976 × <i>g</i> 4700 rpm 16,1 cm
	Cell culture plate 2/8	 5820 756.004	flat 47 mm/64 mm	3976 × <i>g</i> 4700 rpm 16,1 cm
	Kit 1/4	 5820 756.004	flat 47 mm/64 mm	3976 × <i>g</i> 4700 rpm 16,1 cm
	IsoRack 24 × 0.5 mL micro test tubes 1/4	Plate carrier +  5825 708.008	open Ø 6 mm 47 mm/64 mm	3803 × <i>g</i> 4700 rpm 15.4 cm

Plate	Plate Capacity Number per adapter/rotor	Adapter Order no. (international)	Bottom shape Max. loading height	Max. <i>g</i> -force Max. speed Radius
	IsoRack 24 × 1.5/2 mL micro test tubes 1/4	Plate carrier +  5825 709.004	open Ø 11 mm 47 mm/64 mm	3704 × <i>g</i> 4700 rpm 15.0 cm
	PCR plate 384 wells 1/4	Plate carrier +  5825 713.001	flat 47 mm/64 mm	3754 × <i>g</i> 4700 rpm 15,2 cm
	PCR plate 96 wells 1/2	Plate carrier +  5825 711.009	conical 47 mm/64 mm	3803 × <i>g</i> 4700 rpm 15.4 cm
Slides	CombiSlide 12 slides 12/48	Plate carrier +  5825 706.005	flat 47 mm/64 mm	3877 × <i>g</i> 4700 rpm 15,7 cm

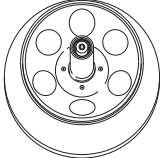
Rotors for Centrifuge 5920 R













Centrifuge 5920 R










English (EN)

12.3 Rotor F-6x85

Fixed-angle rotor for 6 tubes 85 mL

	Max. <i>g</i> -force:	18514 × <i>g</i>
	Max. speed:	12000 rpm
Rotor F-6x85	Max. load (adapter, tube and contents):	6 × 125 g

Tube	Tube Capacity Tubes per adapter/ rotor	Adapter Order no. (international)	Bottom shape Tube diameter Max. tube length with rotor lid	Max. <i>g</i> -force Max. speed Radius
	Micro test tube 1.5 mL/2 mL 4/24	 5804 770.005	round Ø 11 mm 43 mm	18192 × <i>g</i> 12000 rpm 11,3 cm
	Round-bottom tube 2 mL – 5 mL 3/24	 5804 738.004	round Ø 13 mm 80 mm	17065 × <i>g</i> 12000 rpm 10,6 cm
	Round-bottom tube 4 mL – 7 mL 3/18	 5804 739.000	round Ø 13 mm 107 mm	18353 × <i>g</i> 12000 rpm 11,4 cm
	Eppendorf Tubes 5 mL 1/6	 5804 777.000	conical Ø 17 mm –	16904 × <i>g</i> 12000 rpm 10,5 cm
	Round-bottom tube 7 mL – 15 mL 2/12	 5804 771.001	round Ø 16 mm 112 mm	18031 × <i>g</i> 12000 rpm 11,2 cm
	Round-bottom tube 15 mL – 18 mL 1/6	 5804 772.008	round Ø 18 mm 123 mm	17548 × <i>g</i> 12000 rpm 10,9 cm

Tube	Tube Capacity Tubes per adapter/ rotor	Adapter Order no. (international)	Bottom shape Tube diameter Max. tube length with rotor lid	Max. <i>g</i>-force Max. speed Radius
	Conical tube 15 mL 1/6	 5804 776.003	conical Ø 17,5 mm 123 mm	$17226 \times g$ 12000 rpm 10,7 cm
	Round-bottom tube 20 mL – 30 mL 1/6	 5804 773.004	round Ø 26 mm 123 mm	$17709 \times g$ 12000 rpm 11.0 cm
	Round-bottom tube 50 mL 1/6	 5804 774.000	round Ø 29 mm 123 mm	$18031 \times g$ 12000 rpm 11.2 cm
	Conical tube 50 mL 1/6	 5804 775.007	conical Ø 29.5 mm 121 mm	$17387 \times g$ 12000 rpm 10.8 cm
	Round-bottom tube 85 mL –/6	–	– Ø 38 mm 121 mm	$18514 \times g$ 12000 rpm 11,5 cm

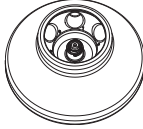
Rotors for Centrifuge 5920 R



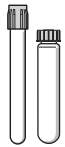







Centrifuge 5920 R










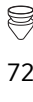

English (EN)

12.4 Rotor FA-6x50

Aerosol-tight fixed-angle rotor for 6 conical tubes

	Max. <i>g</i> -force:	20130 × <i>g</i>
	Max. speed:	12100 rpm
Rotor FA-6x50	Max. load (adapter, tube and contents):	6 × 75 g

Tube	Tube Capacity Tubes per adapter/ rotor	Adapter Order no. (international)	Bottom shape Tube diameter Max. tube length with rotor lid	Max. <i>g</i> -force Max. speed Radius
	Round-bottom tube 16 mL 1/6	 5820 720.000	round Ø 18.1 mm 107 mm	19642 × <i>g</i> 12100 rpm 12.0 cm
	Round-bottom tube 2.6 mL – 5 mL (Ø 13 mm × 75 mm) 1/6	 5820 726.008	round Ø 13.5 mm –	19642 × <i>g</i> 12100 rpm 12.0 cm
	Round-bottom tube 4 mL – 8 mL (Ø 13 mm × 100 mm) 1/6	 5820 725.001	round Ø 13.5 mm 119 mm	19642 × <i>g</i> 12100 rpm 12.0 cm
	Eppendorf Tubes 5 mL 1/6	 5820 730.005	conical Ø 17 mm –	19806 × <i>g</i> 12100 rpm 12.1 cm
	Round-bottom tube 5.5 mL – 10 mL (Ø 16 mm × 75 mm) 1/6	 5820 728.000	round Ø 16 mm –	19642 × <i>g</i> 12100 rpm 12.0 cm

Tube	Tube Capacity Tubes per adapter/ rotor	Adapter Order no. (international)	Bottom shape Tube diameter Max. tube length with rotor lid	Max. <i>g</i> -force Max. speed Radius
	Round-bottom tube 7.5 mL – 12 mL (Ø 16 mm x 100 mm) 1/6	 5820 727.004	round Ø 16.4 mm 119 mm	19642 × <i>g</i> 12100 rpm 12.0 cm
	Tube 9 mL 1/6	 5820 729.007	round Ø 16.4 mm 112 mm	19642 × <i>g</i> 12100 rpm 12.0 cm
	Conical tube 15 mL 1/6	 5820 717.009	conical Ø 17 mm 125 mm	19642 × <i>g</i> 12100 rpm 12.0 cm
	Round-bottom tube 30 mL 1/6	 5820 721.006	round Ø 25.7 mm 104 mm	17187 × <i>g</i> 12100 rpm 10.5 cm
	Conical tube 35 mL 1/6	 5820 722.002	conical Ø 28.7 mm 113 mm	18333 × <i>g</i> 12100 rpm 11.2 cm
	Conical tube 50 mL 1/6	–	conical Ø 30 mm 127 mm	20133 × <i>g</i> 12100 rpm 12.3 cm

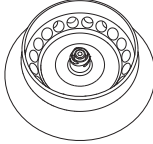
Rotors for Centrifuge 5920 R








Centrifuge 5920 R

English (EN)

12.5 Rotor FA-20x5

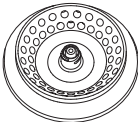
Aerosol-tight fixed-angle rotor for 20 tubes










	Max. <i>g</i> -force:	20913 × <i>g</i>
	Max. speed:	13100 rpm
Rotor FA-20x5	Max. load (adapter, tube and contents):	20 × 9.5 g

Tube	Tube Capacity Tubes per adapter/ rotor	Adapter Order no. (international)	Bottom shape Tube diameter	Max. <i>g</i> -force Max. speed Radius
	HPLC vessel 1/20	 5820 770.007	Ø 11 mm	17076 × <i>g</i> 13100 rpm 8.9 cm
	Cryo tube 1.0 mL/2.0 mL 1/20	 5820 769.009	Ø 13 mm	18802 × <i>g</i> 13100 rpm 9.8 cm
	Reaction tube 1.5 mL/2.0 mL 1/20	 5820 768.002	open Ø 11 mm	18227 × <i>g</i> 13100 rpm 9.5 cm
	Eppendorf Tubes 5 mL -/20		conical Ø 17 mm	20913 × <i>g</i> 13100 rpm 10.9 cm

12.6 Rotor FA-48x2

Aerosol-tight fixed-angle rotor for 48 tubes

	Max. <i>g</i> -force:	
	Outer ring	21 194 × <i>g</i>
	Inner ring	18 676 × <i>g</i>
Max. speed:		13 700 rpm
Rotor FA-48x2	Max. load (adapter, tube and contents):	48 × 3.75 g

Tube	Tube Capacity Tubes per adapter/ rotor	Adapter Order no. (international)	Bottom shape Tube diameter	Max. <i>g</i> -force
				Outer ring Inner ring Max. speed Radius Outer ring Inner ring
	PCR tube 0.2 mL 1/48	 5425 715.005	conical Ø 6 mm	16 787 × <i>g</i> 14 269 × <i>g</i> 13 700 rpm 8 cm 6,8 cm
	Micro test tube 0.4 mL 1/48	 5425 717.008	conical Ø 6 mm	21 194 × <i>g</i> 18 676 × <i>g</i> 13 700 rpm 10,1 cm 8.9 cm
	Micro test tube 0.5 mL 1/48	 5425 716.001	– Ø 8 mm	18 885 × <i>g</i> 16 367 × <i>g</i> 13 700 rpm 9 cm 7.8 cm
	Microtainers 0.6 mL 1/48	 5425 716.001	– Ø 8 mm	21 194 × <i>g</i> 18 676 × <i>g</i> 13 700 rpm 10,1 cm 8.9 cm
	Micro test tube 1.5 mL/2 mL –/48		round Ø 11 mm	21 194 × <i>g</i> 18 676 × <i>g</i> 13 700 rpm 10,1 cm 8.9 cm

Rotors for Centrifuge 5920 R

Centrifuge 5920 R

English (EN)

13 Ordering information

13.1 Centrifuge 5920 R

Order no. (International)	Order no. (North America)	Description
5948 000.018	–	Centrifuge 5920 R without rotor 230 V, 50 Hz – 60 Hz
5948 000.131	5948000131	120 V, 50 Hz – 60 Hz

13.2 Rotors and accessories

The order numbers for the adapter can be found in the chapter "Rotors for Centrifuge 5920 R". (see p. 67)

13.2.1 Rotor S-4x1000

Order no. (International)	Order no. (North America)	Description
5895 100.007	5895100007	Rotor S-4x1000 incl. round bucket
5895 101.003	5895101003	without bucket
5895 103.006	5895103006	Round bucket S-4x1000 2 pieces
5895 102.000	5895102000	4 pieces
5820 747.005	5820747005	Aerosol-tight cap Rotors S-4-104, S-4x750, S-4x1000, round bucket 750 mL/1000 mL 2 pieces
5820 749.008	5820749008	Sealings for aerosol-tight caps Rotors S-4-104, S-4x750, S-4x1000, round bucket 750 mL/1000 mL 4 pieces

Order no. (International)	Order no. (North America)	Description
5895 118.003	5895118003	Rotor S-4x1000 incl. High-Capacity Buckets
5895 107.001	5895107001	High-Capacity Bucket S-4x1000 2 pieces
5895 106.005	5895106005	4 pieces
5920 729.004	5920729004	Plate carrier Rotor S-4x1000, High-Capacity Bucket 2 pieces

Ordering informationCentrifuge 5920 R
English (EN)

Order no. (International)	Order no. (North America)	Description
5895 117.007	5895117007	Rotor S-4x1000 incl. Plate/Tube Buckets
5895 105.009 5895 104.002	5895105009 5895104002	Plate/Tube Bucket S-4x1000 2 pieces 4 pieces
5895 111.009	5895111009	Aerosol-tight cap Rotor S-4x1000: Plate/Tube Bucket, Rotor S-4x750: Plate Bucket 2 pieces
5820 780.002	5820780002	Sealings for aerosol-tight caps Rotors S-4-104, S-4x750, S-4x1000, Plate/Tube Bucket 4 pieces
5920 705.008	5920705008	Plate carrier Rotor S-4x1000, Plate/Tube Bucket 2 pieces

13.2.2 Rotor S-4x750

Order no. (International)	Order no. (North America)	Description
5895 120.008	5895120008	Rotor S-4x750 incl. round bucket
5895 123.007 5895 122.000	5895123007 5895122000	Round bucket S-4x750 2 pieces 4 pieces
5820 747.005	5820747005	Aerosol-tight cap Rotors S-4-104, S-4x750, S-4x1000, round bucket 750 mL/1000 mL 2 pieces
5820 749.008	5820749008	Sealings for aerosol-tight caps Rotors S-4-104, S-4x750, S-4x1000, round bucket 750 mL/1000 mL 4 pieces

Order no. (International)	Order no. (North America)	Description
5895 128.009	5895128009	Rotor S-4x750 incl. plate bucket
5895 125.000 5895 124.003	5895125000 5895124003	Plate bucket (aerosol-tight capable) for Rotor S-4x750 2 pieces 4 pieces
5820 748.001	5820748001	Aerosol-tight cap Rotors S-4-104, S-4x750, Plate Bucket 2 pieces
5820 780.002	5820780002	Sealings for aerosol-tight caps Rotors S-4-104, S-4x750, S-4x1000, Plate/Tube Bucket 4 pieces
5820 756.004	5820756004	Plate carrier Rotors A-2-DWP-AT, S-4-104, S-4x750 2 pieces

13.2.3 Rotor F-6x85

Order no. (International)	Order no. (North America)	Description
5895 140.009	5895140009	Rotor F-6x85 6 × 85 mL tubes incl. rotor lid, Centrifuge 5920 R
5895 141.005 5804 727.509	5895141005 022662961	Rotor lid F-34-6-38, F-6x85 Polypropylene aluminum

13.2.4 Rotor FA-6x50

Order no. (International)	Order no. (North America)	Description
5895 150.004	5895150004	Rotor FA-6x50 aerosol-tight, 6 × 50 mL conical tubes incl. aerosol-tight rotor lid, Centrifuge 5920 R
5895 151.000	5895151000	Rotor lid FA-6x50 aerosol-tight, aluminum
5418 709.008	022652109	Seal for rotor lid FA-45-18-11 (5418/5418 R), FA-45-6-30 (5804/5804 R/5810/5810 R), FA-6x50 (5920 R) 5 pieces

13.2.5 Rotor FA-20x5

Order no. (International)	Order no. (North America)	Description
5895 130.003	5895130003	Rotor FA-20x5 aerosol-tight, 20 × 5 mL tubes incl. aerosol-tight rotor lid, Centrifuge 5920 R
5895 131.000	5895131000	Rotor lid FA-20x5 aerosol-tight, aluminum
5409 718.002	5409718002	Seal for rotor lid FA-45-48-11 (5427 R/5430/5430 R), FA-45-20-17 (5804/5804 R/5810/ 5810 R), FA-20x5 (5920 R) 5 pieces

Ordering information

Centrifuge 5920 R
English (EN)

13.2.6 Rotor FA-48x2

Order no. (International)	Order no. (North America)	Description
5895 135.005	5895135005	Rotor FA-48x2 aerosol-tight, 48 × 1,5/2 mL tubes incl. aerosol-tight rotor lid, Centrifuge 5920 R
5895 136.001	5895136001	Rotor lid FA-48x2 aerosol-tight, aluminum
5820 767.006	5820767006	Seal for rotor lid FA-45-24-11-Kit (5427 R/5430/5430 R), FA-45-48-11 (5804/5804 R/ 5810/5810 R), FA-30x2, FA-48x2 (Centrifuge 5920 R) 5 pieces

13.3 Accessories

Order no. (International)	Order no. (North America)	Description
0113 005.106	–	Rotor key
0113 204.486	–	Mains/power cord 230 V/50 Hz, Europe
0113 204.680	–	230 V/50 Hz, GB/HK
0013 613.953	–	230 V/50 Hz, CN
0113 204.699	–	230 V/50 Hz, AUS
0113 200.863	022664999	120 V/60 Hz, USA
0113 205.105	–	230 V/50 Hz, ARG
5810 350.050	022634330	Pivot grease Tube 20 mL

Index

A

Acceleration ramp	36, 45, 63
Acceleration times	63
Aerosol-tight cap	30
Changing the seal	52
Aerosol-tight centrifugation	30, 32
At set rpm	36, 45

B

Brake off	36
Braking ramp	36, 45, 63

C

Centrifugation time	33
Centrifuge	
Switching off the centrifuge	40
Switching on the centrifuge	20
Centrifuge lid	
Closing the centrifuge lid	31
Gas spring	11, 40, 49
Opening the centrifuge lid	20
Cleaning	50
Close	31
Continuous run	34
Contrast	42
Cycle time	
Cycle time flashes	34
Setting the cycle time	33
Cycles	43
Changing the number of cycles	44
Maximum number of cycles	43
Resetting the number of cycles	44

D

Date	21
Deceleration times	63
Decontamination	54
Device Information	42
Disinfection	50

Display	20, 42
Contrast	42
Display during centrifugation	33
Set value row	42
Disposal	59

E

Emergency release	58
End of centrifugation	34
Ending centrifugation	34
Error message	56

F

Flask 1000 mL	29
---------------------	----

G

g-force	
Setting the g-force	33
Gas spring	11, 40, 49

I

Imbalance calibration	26
Inserting the rotor	22
Installation	
Preparing installation	18
Selecting the location	17

K

Key lock	41
Keys	19

L

Language	21
Lid	
Closing the lid	31
Gas spring	11, 40, 49
Opening the lid	20
Loading buckets	27
Loading plates	28
Loading the rotor	
Fixed-angle rotor	24
Swing-bucket rotor	26

IndexCentrifuge 5920 R
English (EN)

M	
Mains connection	17
Mixed loading.....	30
N	
Number of cycles	43
O	
Open	20
Operating controls.....	19
P	
Program	
Creating a program	45
Options.....	45
Program key.....	46
Program name.....	46
Saving the program.....	46, 46
Program list.....	47
Q	
QuickLock rotor lid.....	25, 32
Quicksaving	46
R	
Radius.....	35, 45
Radius is flashing.....	48
Ramp	36, 63
rcf	
Setting rcf.....	33
Removing the rotor.....	22
Rotational speed	
Setting the rotational speed	33
Rotor	
Cleaning the rotor	51
Resetting the number of cycles	44
Service life exceeded	43
Rotor cycles.....	43
Rotor detection.....	23
Rotor lid	
Closing the QuickLock rotor lid	25
Closing the rotor lid	24
Rotor replacement.....	22
Message after rotor change	23
rpm	
Setting rpm.....	33
Run.....	33
S	
Selecting the location	17
Set value row	20, 42
Short Spin	23, 35
Short spin centrifugation	35
Speaker	42
Speed	33
Speed is flashing	47
Standby	41
Starting centrifugation.....	33
Stop.....	34
Storage.....	59
Switching off.....	40
Switching on	20
T	
Technical data	
Ambient conditions	61
Temperature.....	33
Time	21
Setting the time	33
Time flashes	34
Time counting	
Beginning of time counting.....	36
Timer.....	45
Transporting the bucket.....	30
U	
Unpacking.....	18
V	
Volume	42

Declaration of Conformity

The product named below fulfills the requirements of directives and standards listed. In the case of unauthorized modifications to the product or an unintended use this declaration becomes invalid.

Product name:

Centrifuge 5920 R

including accessories

Product type:

Laboratory Centrifuges

Relevant directives / standards:

2006/95/EC: EN 61010-1, EN 61010-2-020

UL 61010A-1, CAN/CSA C22.2 No. 61010.1

2004/108/EC: EN 55011, EN 61326-1

98/79/EC: EN 14971, EN 61010-2-101, EN 61326-2-6, EN 62366,

EN 18113-1, EN 18113-3, EN 15223-1

2011/65/EU: EN 50581

EN 378-1, EN 378-2

Date: November 19, 2015



Management Board



Portfolio Management

Your local distributor: www.eppendorf.com/contact
Eppendorf AG · 22331 Hamburg · Germany
eppendorf@eppendorf.com

Eppendorf® and the Eppendorf logo are registered trademarks of Eppendorf AG, Germany.
U.S. Design Patents are listed on www.eppendorf.com/ip.
All rights reserved, incl. graphics and pictures. Copyright 2015 © by Eppendorf AG.

www.eppendorf.com

ISO 9001
Certified

ISO
13485
Certified

ISO
14001
Certified

CERTIFICATE OF COMPLIANCE

Certificate Number 20150309-E215059
Report Reference E215059-A7-UL
Issue Date 2015-MARCH-09

Issued to: EPPENDORF A G
BARKHAUSENWEG 1
22339 HAMBURG GERMANY

This is to certify that representative samples of LABORATORY USE ELECTRICAL EQUIPMENT
Centrifuge 5948 (5920 R)

Have been investigated by UL in accordance with the Standard(s) indicated on this Certificate.

Standard(s) for Safety: UL 61010-1 Safety Requirements For Electrical Equipment For Measurement, Control, And Laboratory Use - Part 1: General Requirements
CAN/CSA C22.2 NO. 61010-1 Safety Requirements For Electrical Equipment For Measurement, Control, And Laboratory Use — Part 1: General Requirements

Additional Information: See the UL Online Certifications Directory at www.ul.com/database for additional information

Only those products bearing the UL Certification Mark should be considered as being covered by UL's Certification and Follow-Up Service.

Look for the UL Certification Mark on the product.



Bruce Mahrenholz, Assistant Chief Engineer, Global Inspection and Field Services

UL LLC

Any information and documentation involving UL Mark services are provided on behalf of UL LLC (UL) or any authorized licensee of UL. For questions, please contact a local UL Customer Service Representative at <http://ul.com/aboutul/locations/>





Certificate of Containment Testing

Containment Testing of Rotor S-4x1000 (5895 100.104-00) with Roundbuckets (5895 102.115-00*) and Caps (5820 741.309-00[#]) in an Eppendorf Bench Top Centrifuge

Report No. 14/034

Report Prepared For: Eppendorf AG, Hamburg, Germany

Issue Date: 17th February 2015

Test Summary

Rotor S-4x1000 (5895 100.104-00) with Roundbuckets (5895 102.115-00*) and Caps (5820 741.309-00[#]) was containment tested in an Eppendorf bench top centrifuge, using Annex AA of IEC 61010-2-020:2006 (2nd Ed.). The sealed bucket was shown to contain a spill.

Report Written By

Name: Ms Anna Moy

Title: Biosafety Scientist

Report Authorised By

Name: Mrs Sara Speight

Title: Senior Biosafety Scientist



Public Health
England

Public Health England
Microbiology Services
Porton Down
Salisbury
Wiltshire
SP4 OJG

Certificate of Containment Testing

Containment Testing of Rotor S-4x1000 (5895 100.104-00) with Plate Buckets (5895 104.118-00*) and Caps (5895 104.304-00[#]) in an Eppendorf Bench Top Centrifuge

Report No. 14/044 B

Report Prepared For: Eppendorf AG, Hamburg, Germany

Issue Date: 17th February 2015

Test Summary

Rotor S-4x750 (5895 100.104-00) with Plate Buckets (5895 104.118-00*) and Caps (5895 104.304-00[#]) was containment tested in an Eppendorf bench top centrifuge, using Annex AA of IEC 61010-2-020:2006 (2nd Ed.). The sealed buckets were shown to contain a spill.

Report Written By

Name: Ms Anna Moy

Title: Biosafety Scientist

Report Authorised By

Name: Mrs Sara Speight

Title: Senior Biosafety Scientist

Please be aware that the use of the Royal Coat of Arms is highly restricted and cannot be copied. Please do not put the PHE logo on your website or use our name to endorse your products. Any reference to PHE needs to be approved by us before it can be used.

* Part no. will form part of catalogue number 5895 117.007; 5895 104.002; 5895 105.009

Part no. will form part of catalogue number 5885 111.009



Certificate of Containment Testing

Containment Testing of Rotor S-4x1000 (5895 100.104-00) with DWP Buckets (5895 104.118-00*) and Caps (5820 743.301-00[#]) in an Eppendorf Bench Top Centrifuge

Report No. 14/044 A

Report Prepared For: Eppendorf AG, Hamburg, Germany

Issue Date: 17th February 2015

Test Summary

Rotor S-4x750 (5895 100.104-00) with DWP Buckets (5895 104.118-00*) and Caps (5820 743.301-00[#]) was containment tested in an Eppendorf bench top centrifuge, using Annex AA of IEC 61010-2-020:2006 (2nd Ed.). The sealed buckets were shown to contain a spill.

Report Written By

Name: Ms Anna Moy

Title: Biosafety Scientist

Report Authorised By

Name: Mrs Sara Speight

Title: Senior Biosafety Scientist

Please be aware that the use of the Royal Coat of Arms is highly restricted and cannot be copied. Please do not put the PHE logo on your website or use our name to endorse your products. Any reference to PHE needs to be approved by us before it can be used.

* Part no. will form part of catalogue number 5895 117.007; 5895 104.002; 5895 105.009

Part no. will form part of catalogue number 5820 748.001



Certificate of Containment Testing

Containment Testing of Caps (5820 741.309-00) for Rotor S- 4x750 with Roundbuckets (5895 102.115-00) in the Eppendorf 5920/R Bench Top Centrifuge

Report No. 14/014

Report Prepared For: Eppendorf AG, Hamburg, Germany

Issue Date: 26th June 2014

Test Summary

Caps (5820 741.309-00) for rotor S-4x750 with Roundbuckets (5895 102.115-00) were containment tested in the Eppendorf 5920/R bench top centrifuge, using Annex AA of IEC 61010-2-020:2006 (2nd Ed.). The sealed rotor was shown to contain a spill within the centrifuge.

Report Written By

Name: Mr Matthew Hewitt

Title: Biosafety Scientist

Report Authorised By

Name: Mrs Sara Speight

Title: Senior Biosafety Scientist



Public Health
England

Public Health England
Microbiology Services
Porton Down
Salisbury
Wiltshire
SP4 OJG

Certificate of Containment Testing

Containment Testing of Rotor S-4x750 (5895 120.105-00) with Plate Buckets (5895 124.119-00*) and Caps (5895 104.304-00[#]) in an Eppendorf Bench Top Centrifuge

Report No. 14/043 B

Report Prepared For: Eppendorf AG, Hamburg, Germany

Issue Date: 17th February 2015

Test Summary

Rotor S-4x750 (5895 120.105-00) with Plate Buckets (5895 124.119-00*) and Caps (5895 104.304-00[#]) was containment tested in an Eppendorf bench top centrifuge, using Annex AA of IEC 61010-2-020:2006 (2nd Ed.). The sealed buckets were shown to contain a spill.

Report Written By

Name: Ms Anna Moy

Title: Biosafety Scientist

Report Authorised By

Name: Mrs Sara Speight

Title: Senior Biosafety Scientist

Please be aware that the use of the Royal Coat of Arms is highly restricted and cannot be copied. Please do not put the PHE logo on your website or use our name to endorse your products. Any reference to PHE needs to be approved by us before it can be used.

* Part no. will form part of catalogue number 5895 128.009; 5895 124.003; 5895 125.000

Part no. will form part of catalogue number 5895 111.009



Public Health
England

Public Health England
Microbiology Services
Porton Down
Salisbury
Wiltshire
SP4 OJG

Certificate of Containment Testing

Containment Testing of Rotor S-4x750 (5895 120.105-00) with Plate Buckets (5895 124.119-00*) and Caps (5820 743.301-00[#]) in an Eppendorf Bench Top Centrifuge

Report No. 14/043 A

Report Prepared For: Eppendorf AG, Hamburg, Germany

Issue Date: 17th February 2015

Test Summary

Rotor S-4x750 (5895 120.105-00) with Plate Buckets (5895 124.119-00*) and Caps (5820 743.301-00[#]) was containment tested in an Eppendorf bench top centrifuge, using Annex AA of IEC 61010-2-020:2006 (2nd Ed.). The sealed buckets were shown to contain a spill.

Report Written By

Name: Ms Anna Moy

Title: Biosafety Scientist

Report Authorised By

Name: Mrs Sara Speight

Title: Senior Biosafety Scientist

Please be aware that the use of the Royal Coat of Arms is highly restricted and cannot be copied. Please do not put the PHE logo on your website or use our name to endorse your products. Any reference to PHE needs to be approved by us before it can be used.

* Part no. will form part of catalogue number 5895 128.009; 5895 124.003; 5895 125.000

Part no. will form part of catalogue number 5820 748.001



Certificate of Containment Testing

Containment Testing of Rotor FA-6x50 (5895 150.101-00*) in an Eppendorf Bench Top Centrifuge

Report No. 14/029 A

Report Prepared For: Eppendorf AG, Hamburg, Germany

Issue Date: 17th February 2015

Test Summary

Rotor FA-6x50 (5895 150.101-00*) was containment tested in an Eppendorf bench top centrifuge, using Annex AA of IEC 61010-2-020:2006 (2nd Ed.). The sealed rotor was shown to contain a spill.

Report Written By

Name: Ms Anna Moy

Title: Biosafety Scientist

Report Authorised By

Name: Mrs Sara Speight

Title: Senior Biosafety Scientist

Please be aware that the use of the Royal Coat of Arms is highly restricted and cannot be copied. Please do not put the PHE logo on your website or use our name to endorse your products. Any reference to PHE needs to be approved by us before it can be used.



Certificate of Containment Testing

Containment Testing of Rotor FA-20x5 (5895 130.100-00*) in an Eppendorf Bench Top Centrifuge

Report No. 14/029 B

Report Prepared For: Eppendorf AG, Hamburg, Germany

Issue Date: 17th February 2015

Test Summary

Rotor FA-20x5 (5895 130.100-00*) was containment tested in an Eppendorf bench top centrifuge, using Annex AA of IEC 61010-2-020:2006 (2nd Ed.). The sealed rotor was shown to contain a spill.

Report Written By

Name: Ms Anna Moy

Title: Biosafety Scientist

Report Authorised By

Name: Mrs Sara Speight

Title: Senior Biosafety Scientist



Certificate of Containment Testing

Containment Testing of Rotor FA-48x2 (5895 135.102-00*) in an Eppendorf Bench Top Centrifuge

Report No. 14/029 C

Report Prepared For: Eppendorf AG, Hamburg, Germany

Issue Date: 17th February 2015

Test Summary

Rotor FA-48x2 (5895 135.102-00*) was containment tested in an Eppendorf bench top centrifuge, using Annex AA of IEC 61010-2-020:2006 (2nd Ed.). The sealed rotor was shown to contain a spill.

Report Written By

Name: Ms Anna Moy

Title: Biosafety Scientist

Report Authorised By

Name: Mrs Sara Speight

Title: Senior Biosafety Scientist

Evaluate Your Manual

Give us your feedback.
www.eppendorf.com/manualfeedback