

memmert

UN_{xx} | UF_{xx}

IN_{xx} | IF_{xx}

UN_{xxm} | UF_{xxm}

IN_{xxm} | IF_{xxm}



OPERATING INSTRUCTIONS

UNIVERSAL OVEN U
INCUBATOR I

MADE IN GERMANY.

www.memmert.com

Manufacturer and customer service

Memmert GmbH + Co. KG
Willi-Memmert-Straße 90–96
D-91186 Büchenbach
Deutschland

Phone: +49 (0)9122 925-0
Fax: +49 (0)9122 14585
E-mail: sales@memmert.com
Internet: www.memmert.com

Customer service:

Service hotline: +49 (0)9171 9792 911
Service fax: +49 (0)9171 9792 979
E-mail: service@memmert.com

When contacting customer service, always quote the product serial number on the nameplate (see page 13).

Shipping address for repairs:

Memmert GmbH + Co. KG
Kundenservice
Willi-Memmert-Str. 90-96
DE-91186 Büchenbach
Germany

Please contact our customer service before sending appliances for repair or before returning equipment, otherwise, we have to refuse acceptance of the shipment.

© 2020 MEMMERT GmbH + Co. KG

D33363 | Date 01/2020

We reserve the right to make changes

About this manual

Purpose and target group

This manual describes the construction, function, transport and operation of the universal ovens UN_{xx}/UF_{xx}/UN_{xx}m/UF_{xx}m and the incubators IN_{xx}/IF_{xx}/IN_{xx}m/IF_{xx}m. It is intended for use by trained personnel of the owner who have the task of operating and/or maintaining the respective appliance.

If you are asked to work on the appliance, read this manual carefully before starting. Familiarise yourself with the safety regulations. Only perform work that is described in this manual. If there is something you do not understand, or certain information is missing, ask your superior or contact the manufacturer. Do not do anything without authorisation.

Versions

The appliances are available in different configurations and sizes. If specific equipment features or functions are available only for certain configurations, this is indicated at the relevant points in this manual.

The functions described in this manual refer to the latest firmware version.

Due to individual configurations and sizes, illustrations in this manual may be slightly different from the actual appearance. Function and operation are identical.

Other documents that have to be observed:

- ▶ For operation of the appliance with MEMMERT AtmoCONTROL, observe the separate software manual
- ▶ For service and repair (see page 46), please refer to the separate service manual

Storage and forwarding

This instruction manual belongs with the appliance and should always be stored where persons working on the appliance have access to it. It is the responsibility of the owner to ensure that persons who are working or will work on the appliance are informed as to the whereabouts of this instruction manual. We recommend that it is always stored in a protected location close to the appliance. Make sure that the instruction manual is not damaged by heat or humidity. If the appliance is sold on or transported and then set up again at a different location, the operating instructions must go with it.

You will find the current version of our operating manual as pdf file if you go to www.memmert.com/de/service/downloads/bedienungsanleitung/.

Contents

| | |
|---|-----------|
| 1. For your Safety | 6 |
| 1.1 Terms and signs used..... | 6 |
| 1.2 Product safety and dangers | 7 |
| 1.3 Requirements of the operating personnel..... | 8 |
| 1.4 Responsibility of the owner..... | 8 |
| 1.5 Changes and alterations..... | 8 |
| 1.6 Behaviour in case of malfunctions and irregularities..... | 8 |
| 1.7 Switching off the appliance in an emergency | 9 |
| 2. Construction and description | 10 |
| 2.1 Construction | 10 |
| 2.2 Function..... | 12 |
| 2.3 Material..... | 12 |
| 2.4 Electrical equipment..... | 12 |
| 2.5 Connections and interfaces..... | 13 |
| 2.6 Designation (nameplate)..... | 13 |
| 2.7 Technical data | 14 |
| 2.8 Declaration of conformity | 15 |
| 2.9 Ambient conditions..... | 15 |
| 2.10 Scope of delivery | 16 |
| 2.11 Optional accessories | 16 |
| 3. Delivery, transport and setting up | 17 |
| 3.1 For your Safety..... | 17 |
| 3.2 Delivery | 18 |
| 3.3 Transport..... | 18 |
| 3.4 Unpacking | 18 |
| 3.5 Storage after delivery | 18 |
| 3.6 Setting up | 19 |
| 4. Putting into operation | 23 |
| 4.1 Connecting the appliance | 23 |
| 4.2 Switching on..... | 24 |
| 5. Operation and control | 25 |
| 5.1 Operating personnel..... | 25 |
| 5.2 Opening the door..... | 25 |
| 5.3 Loading the appliance | 26 |
| 5.4 Operating the appliance..... | 26 |
| 5.5 Temperature monitoring | 30 |
| 5.6 Ending operation..... | 32 |

| | |
|---|-----------|
| 6. Malfunctions, warning and error messages | 33 |
| 6.1 Warning messages of the temperature monitoring function | 33 |
| 6.2 Malfunctions, operating problems and appliance errors | 34 |
| 6.3 Power failure..... | 35 |
| 7. Menu mode | 36 |
| 7.1 Overview | 36 |
| 7.2 Basic operation in menu mode using the example of language selection..... | 37 |
| 7.3 Setup..... | 38 |
| 7.4 Date and Time | 42 |
| 7.5 Calibration | 44 |
| 8. Maintenance and service | 46 |
| 8.1 Cleaning..... | 46 |
| 8.2 Regular maintenance..... | 46 |
| 8.3 Repairs and service | 46 |
| 9. Storage and disposal | 47 |
| 9.1 Storage | 47 |
| 9.2 Disposal | 47 |

1. For your Safety

1.1 Terms and signs used

In this manual and on the appliance itself, certain common terms and signs are used to warn you of possible dangers or to give you hints that are important in avoiding injury or damage. Observe and follow these hints and regulations to avoid accidents and damage. These terms and signs are explained below.

1.1.1 Terms used

"Warning" is used whenever you or somebody else could be injured if you do not observe the accompanying safety regulation.

"Caution" is used for information that is important for avoiding damage.

1.1.2 Signs used

| Warning signs (warning of a danger) | | | | | |
|--|--|---------------------------|--|-------------------------|---|
| | | | | | |
| Danger of electrocution | Danger of explosion | Dangerous gases / vapours | Danger of burns | Danger of toppling over | Hazard area! Observe the operating instructions |
| Prohibition signs (forbidding an action) | | | | | |
| | | | | | |
| Do not lift | Do not tilt | Do not enter | | | |
| Regulation signs (stipulating an action) | | | | | |
| | | | | | |
| Disconnect the mains plug | Wear gloves | Wear safety boots | Observe information in separate manual | | |
| Other icons | | | | | |
| | Important or useful additional information | | | | |

1.2 Product safety and dangers

The appliances described in this manual are technically sophisticated, manufactured using high-quality materials and subject to many hours of testing in the factory. They contain the latest technology and comply with recognised technical safety regulations. However, there are still risks involved, even when the appliances are used as intended. These are described below.

**Warning!**

After removing covers, live parts may be exposed. You may receive an electric shock if you touch these parts. Disconnect the mains plug before removing any covers. Only electrical technicians may work on the electrical equipment of the appliances.

**Warning!**

When loading the appliance with an unsuitable load, poisonous or explosive vapours or gases may be produced. This could cause the appliance to explode, and persons could be severely injured or poisoned. The appliance may only be loaded with materials/test objects which do not form any toxic or explosive vapours when heated up (see also page 11).

**Warning!**

If the door is open while the appliance is in operation, the appliance may overheat and pose a fire hazard. Do not leave the door open during operation.

**Warning!**

Depending on operation, the surfaces in the working chamber and the chamber load may still be very hot after the appliance is switched off. Touching these surfaces can cause burns. Wear heat-resistant protective gloves or wait until the appliance cools down.

**Warning!**

In case of appliances of a certain size, you can get accidentally locked in, which is life-threatening. Do not climb into the appliance!

1.3 Requirements of the operating personnel

The appliance may only be operated and maintained by persons who are of legal age and have been instructed accordingly. Personnel who are to be trained, instructed or who are undergoing general training may only work with the appliance under the continuous supervision of an experienced person.

Repairs may only be performed by qualified electricians. The regulations in the separate service manual must be observed.

1.4 Responsibility of the owner

The owner of the appliance

- ▶ is responsible for the flawless condition of the appliance and for its proper operation in accordance with its intended use (see page 11);
- ▶ is responsible for ensuring that persons who are to operate or service the appliance are qualified to do this, have been instructed accordingly and are familiar with the operating instructions at hand;
- ▶ must know about the applicable guidelines, requirements and operational safety regulations, and train staff accordingly;
- ▶ is responsible for ensuring that unauthorised persons have no access to the appliance;
- ▶ is responsible for ensuring that the maintenance plan is adhered to and that maintenance work is carried out properly (see page 46);
- ▶ has to ensure that the appliance and its surroundings are kept clean and tidy, for example through corresponding instructions and inspections;
- ▶ is responsible for ensuring that personal protective clothing is worn by operating personnel, e.g. work clothes, safety shoes and protective gloves.

1.5 Changes and alterations

No unauthorised changes or alterations may be made to the appliance. No parts may be added or inserted which have not been approved by the manufacturer.

Unauthorised modifications or changes result in the CE declaration of conformity losing its validity and the appliance must no longer be operated.

The manufacturer is not liable for any damage, danger or injuries that result from unauthorised changes or alterations, or from non-observance of the regulations in this manual.

1.6 Behaviour in case of malfunctions and irregularities

The appliance may only be used in a flawless condition. If you as the operator notice irregularities, malfunctions or damage, immediately take the appliance out of service and inform your superior.

i You can find information on correcting malfunctions from page 33.

1.7 Switching off the appliance in an emergency

Push the On/Off switch on the control panel (Fig. 1) and disconnect power plug. This disconnects the appliance from the power supply at all poles.



Warning! Depending on the operation performed, the surfaces in the working chamber and the chamber load may still be very hot after the appliance is switched off. Touching these surfaces can cause burns. Wear heat-resistant protective gloves or wait until the appliance cools down.

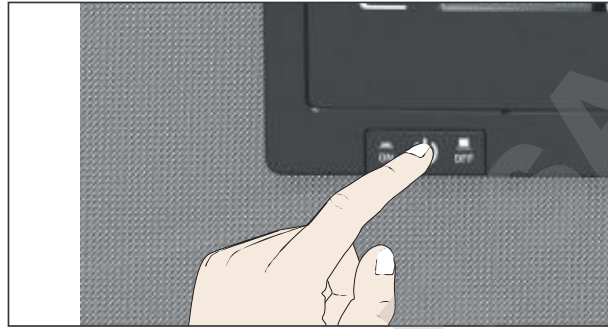

Fig. 1
Switch off the appliance by pressing the On/Off switch

2. Construction and description

2.1 Construction



Fig. 2 Construction

- 1 ControlCOCKPIT with capacitive function keys (see page 27)
- 2 On/Off switch (see page 24)
- 3 Working chamber fan (for UF.../IF... appliances only)

- 4 Steel grid
- 5 Working chamber
- 6 Nameplate (covered, see page 13)
- 7 Door handle (see page 25)
- 8 Turn control with confirmation key

2.2 Intended use

Based on the standards and guidelines listed in the following, the products described in this manual have received a CE label from the company Memmert:



| Product | Intended use | Directives |
|--|--|---|
| UN _{xx} UF _{xx} IN _{xx} IF _{xx} | <p>This appliance is exclusively intended for heating up non-explosive substances and objects. Any other use is improper and may result in hazards and damage.</p> <p>The appliance is not explosion-proof (does not comply with the German occupational health and safety regulation VBG 24). The appliance may only be loaded with materials and substances which cannot form any toxic or explosive vapours at the set temperature and which cannot explode, burst or ignite.</p> <p>The appliance may not be used for the drying, evaporation and burning-in of paints or similar materials, the solvents of which could form an explosive mixture when combined with air. If there is any doubt as to the composition of materials, they must not be loaded into the appliance. Potentially explosive gas-air mixtures must not form, neither in the working chamber nor in the direct vicinity of the appliance.</p> | <ul style="list-style-type: none"> ▶ Directive 2004/108/EC amended (Directive of the European Parliament and of the Council on the approximation of the laws of the Member States relating to electromagnetic compatibility). Standards complied with: DIN EN 61326:2004-05 EN 61326:1997 EN 61326/A1:1998 EN 61326/A2:2001 EN 61326/A2:2003 ▶ Directive 2006/95/EC amended (Directive of the European Parliament and of the Council on the harmonisation of the laws of Member States relating to electrical equipment designed for use within certain voltage limits). Standards complied with: DIN EN 61 010-1 (VDE 0411 part 1) DIN EN 61 010-2-010 (VDE 0411 part 2-010) EN 61 010-1:2001, EN 61 010-2-010 |
| Product | Intended use as a medical device | Directive |
| UN _{xxm} IN _{xxm} UF _{xxm} IF _{xxm} | <p>The appliance may be used for heating fango, silicate and APS packs for physical therapy and keeping them warm.</p> | <p>Directive 93/42/EEC (Council Directive concerning medical devices)</p> |

2.3 Function

Appliances of the UN... and IN... type series feature natural circulation (convection). For the UF... and IF... type series, air is circulated by a fan at the working chamber rear panel Fig. 3, No. 1). It increases the air flow and provides stronger horizontal forced air circulation than natural convection.

In both the convection and fan ventilated appliances, supply air (2) is preheated in a pre-heating chamber (3). Through the ventilation slits in the side panel of the working chamber, the pre-heated air is introduced into the interior of the chamber. The supply and exhaust air (5) volume (air change) is controlled by the air flap (4) on the rear panel of the appliance.

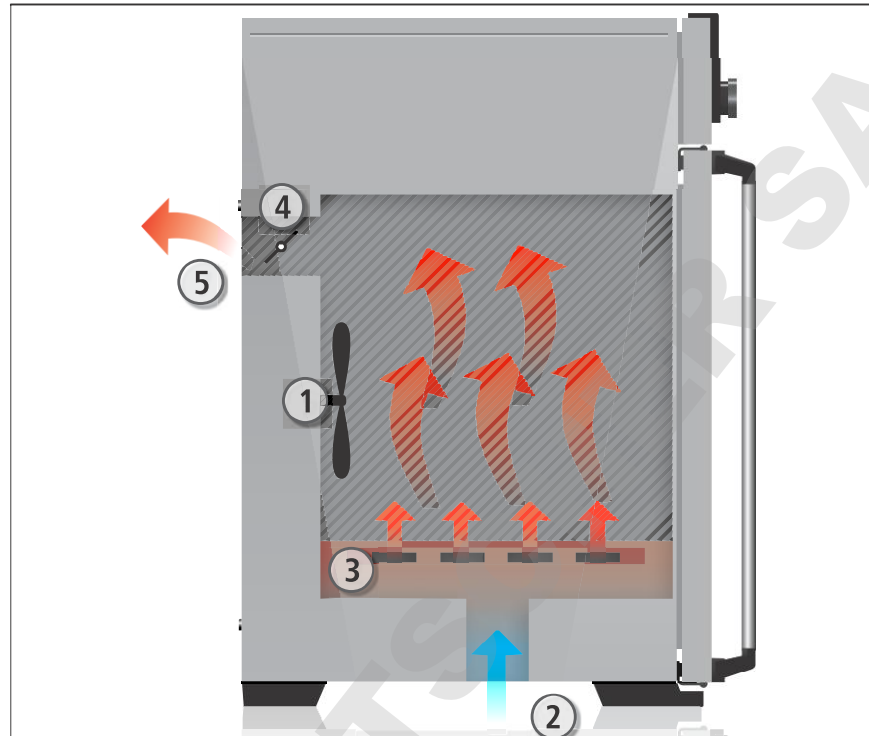

Fig. 3 Function
 1 Fan
 2 Fresh air
 3 Pre-heating chamber
 4 Air flap
 5 Exhaust air

2.4 Material

For the outer housing, MEMMERT deploys stainless steel (Mat.No. 1.4016 – ASTM 430) and for the interior, stainless steel (Mat.No. 1.4301 – ASTM 304) is used, which stands out through its high stability, optimal hygienic properties and corrosion-resistance towards many (but not all!) chemical compounds (caution for example with chlorine compounds).

The chamber load for the appliance must be carefully checked for chemical compatibility with the materials mentioned. A material resistance table can be requested from the manufacturer.

2.5 Electrical equipment

- ▶ Operating voltage and current consumption: See nameplate
- ▶ Protection class I, i.e. operating insulation with PE conductor in accordance with EN 61010
- ▶ Protection type IP 20 acc. to EN 60 529
- ▶ Interference suppression acc. to EN 55011 class B
- ▶ Appliance fuse: Fusible link 250 V/15 A quick-blow
- ▶ The temperature controller is protected with a miniature fuse 100 mA (160 mA at 115 V)

2.6 Connections and interfaces

2.6.1 Electrical connection

This appliance is intended for operation on an electrical power system with a system impedance Z_{max} of a maximum of 0.292 ohm at the point of transfer (service line). The operator must ensure that the appliance is operated only on an electrical power system that meets these requirements. If necessary, you can ask your local energy supply company what the system impedance is.

Observe the country-specific regulations when connecting (e.g. in Germany DIN VDE 0100 with residual current circuit breaker).

2.6.2 Communication interface

The Ethernet interface is intended for appliances which meet the requirements of IEC 60950-1.

Via Ethernet interface, the appliance can be connected to a network to read out protocol logs with AtmoCONTROL, the optional appliance software. The Ethernet interface is located on the rear of the appliance (Fig. 4).

For identification purposes, each appliance connected must have its own unique IP address. Setting the IP address is described on page 38.

With an optional USB to Ethernet converter, the appliance can be directly connected to a computer / laptop (see Optional accessories on page 16).

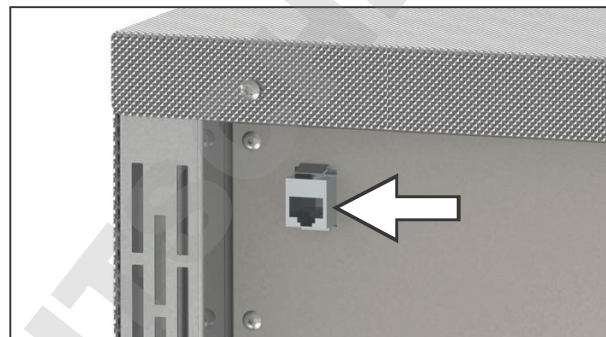

Fig. 4 Ethernet interface

2.7 Designation (nameplate)

The nameplate (Fig. 5) provides information about the appliance model, manufacturer and technical data. It is attached to the front of the appliance, on the right side under the door (see page 10).

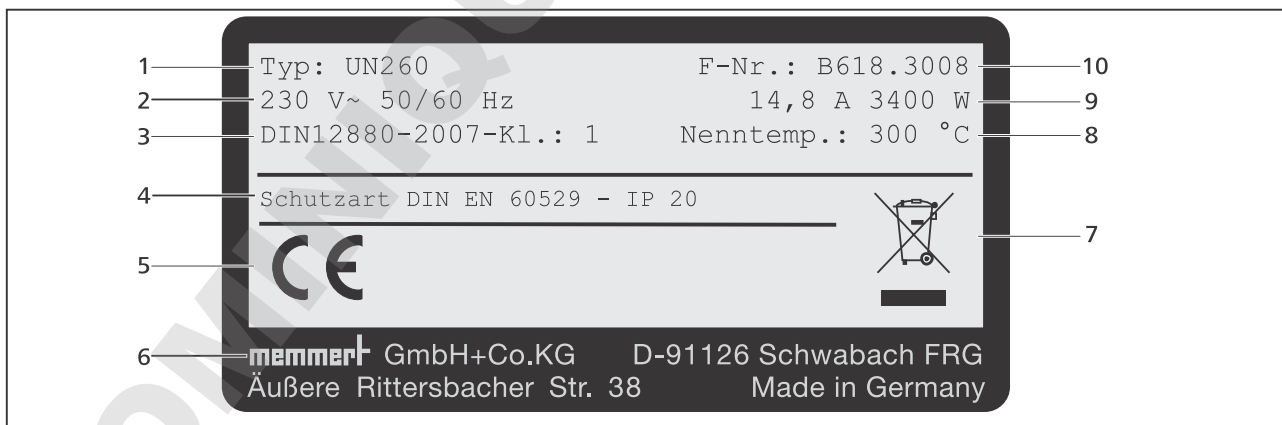

Fig. 5 Nameplate (example)

- | | | | |
|---|-------------------|----|----------------------------|
| 1 | Type designation | 6 | Address of manufacturer |
| 2 | Operating voltage | 7 | Disposal note |
| 3 | Applied standard | 8 | Temperature range |
| 4 | Protection type | 9 | Connection / power ratings |
| 5 | CE conformity | 10 | Appliance number |

2.8 Technical data

| Appliance size | | 30 | 55 | 75 | 110 | 160 | 260 | |
|---|-------|--------------------------------------|------|------|------|------|------|------|
| Appliance width D ¹ [mm] | | 585 | 585 | 585 | 745 | 745 | 824 | |
| Appliance height E ¹ [mm] | | 707 | 787 | 947 | 867 | 1107 | 1186 | |
| Appliance depth F ¹ (footprint) [mm] | | 434 | 514 | 514 | 584 | 584 | 684 | |
| Depth of door lock [mm] | | 56 | | | | | | |
| Working chamber width A ¹ [mm] | | 400 | 400 | 400 | 560 | 560 | 640 | |
| Working chamber height B ¹ [mm] | | 320 | 400 | 560 | 480 | 720 | 800 | |
| Working chamber depth C ¹ [mm] | | 250 | 330 | 330 | 400 | 400 | 500 | |
| Chamber volume [litres] | | 32 | 53 | 74 | 108 | 161 | 256 | |
| Weight [kg] | | 48 | 57 | 66 | 78 | 96 | 110 | |
| Power [W] | I... | 115 V, 50/60 Hz | 800 | 900 | 900 | 900 | 900 | 900 |
| | | 230 V, 50/60 Hz | 1600 | 1000 | 1250 | 1400 | 1600 | 1700 |
| | U... | 230 V, 50/60 Hz | 1600 | 2000 | 2500 | 2800 | 3200 | 3400 |
| | | 115 V, 50/60 Hz | 1600 | 1700 | 1800 | 1800 | 1800 | 1800 |
| Current consumption [A] | I... | 230 V, 50/60 Hz | 7,0 | 4,3 | 5,4 | 6,1 | 7,0 | 7,4 |
| | | 115 V, 50/60 Hz | 7,0 | 7,8 | 7,8 | 7,8 | 7,8 | 7,8 |
| | U... | 230 V, 50/60 Hz | 7,0 | 8,7 | 10,9 | 12,2 | 13,9 | 14,8 |
| | | 115 V, 50/60 Hz | 13,9 | 14,8 | 15,6 | 15,6 | 15,6 | 15,6 |
| max. number of sliding shelves | | 3 | 4 | 6 | 5 | 8 | 9 | |
| max. load per sliding shelf [kg] | | 20 | | | | | | |
| max. load per appliance [kg] | | 60 | 80 | 120 | 175 | 210 | 300 | |
| Setting temperature range | IN/IF | +20 bis +80 °C ² | | | | | | |
| | UN/UF | +20 bis +300 °C ^{2 3} | | | | | | |
| Adjustment precision | IN/IF | 0,1 K | | | | | | |
| | UN/UF | bis 99,9 °C: 0,1 K, ab 100 °C: 0,5 K | | | | | | |

¹ See Fig. 6 on page 15

² With the interior lighting on, the minimum temperature might not be reached.

³ to +250 °C if your device is equipped with a glass door

| Appliance size | 450 | 750 | 1060 |
|---|------|------|------|
| Appliance width D ¹ [mm] | 1224 | 1224 | 1224 |
| Appliance height E ¹ [mm] | 1247 | 1720 | 1720 |
| Appliance depth F ¹ (footprint) [mm] | 784 | 784 | 1035 |
| Depth of door lock [mm] | 56 | | |
| Working chamber width A ¹ [mm] | 1040 | 1040 | 1040 |
| Working chamber height B ¹ [mm] | 720 | 1200 | 1200 |
| Working chamber depth C ¹ [mm] | 600 | 600 | 850 |
| Chamber volume [litres] | 449 | 749 | 1060 |
| Weight [kg] | 170 | 217 | 252 |

| Appliance size | | 450 | 750 | 1060 | |
|----------------------------------|-------|--------------------------------------|----------|----------|----------|
| Power [W] | I... | 115 V, 50/60 Hz | 1500 | 1800 | – |
| | | 230 V, 50/60 Hz | 1800 | 2000 | – |
| | U... | 400 V, 50/60 Hz | 5800 | 7000 | 7000 |
| | | 3 x 230 V o. N., 50/60 Hz | 5800 | 7000 | 7000 |
| | | 3 x 208 V, 50/60 Hz | 4800 | 5700 | 5700 |
| Current consumption [A] | I... | 230 V, 50/60 Hz | 7,8 | 8,7 | – |
| | | 115 V, 50/60 Hz | 13,0 | 15,6 | – |
| | U... | 400 V, 50/60 Hz | 3 x 8,4 | 3 x 10,1 | 3 x 10,1 |
| | | 3 x 230 V o. N., 50/60 Hz | 3 x 14,6 | 3 x 17,6 | 3 x 17,6 |
| | | 3 x 208 V, 50/60 Hz | 3 x 13,3 | 3 x 15,1 | 3 x 15,1 |
| max. number of sliding shelves | | 8 | 14 | 14 | |
| max. load per sliding shelf [kg] | | 30 | | 60 | |
| max. load per appliance [kg] | | 300 | | | |
| Setting temperature range | IN/IF | +20 bis +80 °C ² | | – | |
| | UN/UF | +20 bis +300 °C ^{2 3} | | | |
| Adjustment precision | IN/IF | 0,1 K | | – | |
| | UN/UF | bis 99,9 °C: 0,1 K, ab 100 °C: 0,5 K | | | |

¹ See Fig. 6 on page 15

² With the interior lighting on, the minimum temperature might not be reached.

³ to +250 °C if your device is equipped with a glass door

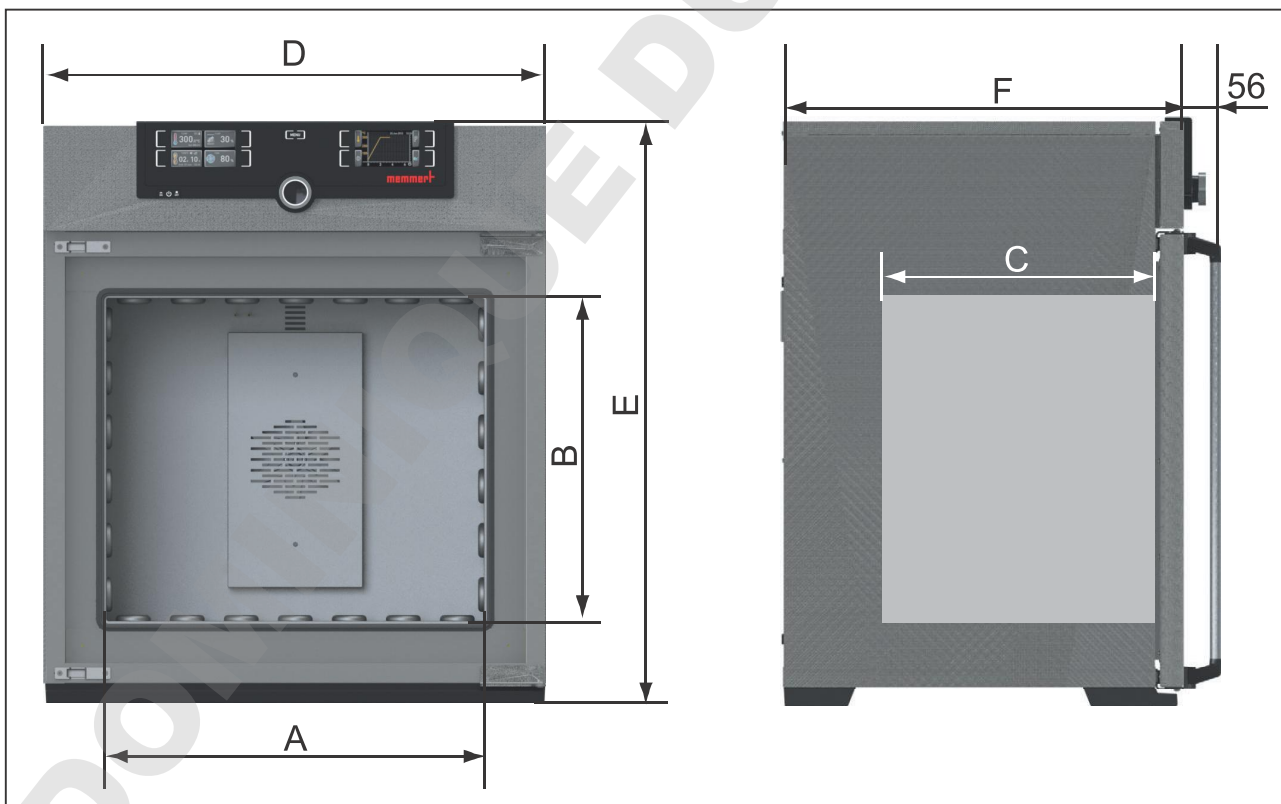

Fig. 6 Dimensions (see table on page 14)

2.9 Declaration of conformity

You can download the EC declaration of conformity of the appliance online:

English: <http://www.memmert.com/en/service/downloads/ce-statement/>

German: <http://www.memmert.com/de/service/downloads/eg-konformitaetserklaerung/>

2.10 Ambient conditions

- ▶ The appliance may only be used in enclosed rooms and under the following ambient conditions:

| | |
|--------------------------|------------------------------|
| Ambient temperature | +5 °C to +40 °C |
| Humidity rh | max. 80 %, non-condensing |
| Overvoltage category | II |
| Pollution degree | 2 |
| Altitude of installation | max. 2,000 m above sea level |

- ▶ The appliance may not be used in areas where there is a risk of explosion. The ambient air must not contain any explosive dusts, gases, vapours or gas-air mixtures. The appliance is not explosion-proof.
- ▶ Heavy dust production or aggressive vapours in the vicinity of the appliance could lead to sedimentation in the interior and, as a consequence, could result in short circuits or damage to electrical parts. For this reason, sufficient measures to prevent large clouds of dust or aggressive vapours from developing should be taken.

2.11 Scope of delivery

- ▶ Power cable
- ▶ Tilt protection
- ▶ One or two sliding steel grids (load capacity 30 kg each)
- ▶ The operating instructions at hand
- ▶ Calibration certificate

2.12 Optional accessories

- ▶ AtmoCONTROL software for reading out and processing of protocol log files
- ▶ USB to Ethernet converter (Fig. 7). Makes it possible to connect the appliance's network interface (see page 13) to the USB port of a computer / laptop.
- ▶ Reinforced, sliding steel grids with a load capacity of 60 kg each (for appliance size 110 and larger)

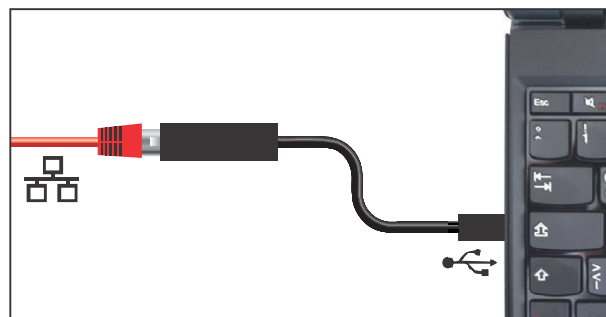

Fig. 7 Converter USB to Ethernet

3. Delivery, transport and setting up

3.1 For your Safety



Warning!

Because of the heavy weight of the appliance, you could injure yourself if you try to lift it. To carry appliances of the sizes 30 and 55, at least two persons, for appliances of the sizes 75, 110, 160 and 260, four people are needed. Appliances larger than that may not be carried but must be transported with a manual pallet jack or forklift truck.

| 30 | 55 | 75 | 110 | 160 | 260 | 450 | 750 |
|----|----|----|-----|-----|-----|-----|-----|
| | | | | | | | |



Warning!

You may get your hands or feet squashed when transporting and installing the appliance. Wear protective gloves and safety boots. When grasping the bottom of the appliance, grasp it only on the sides:

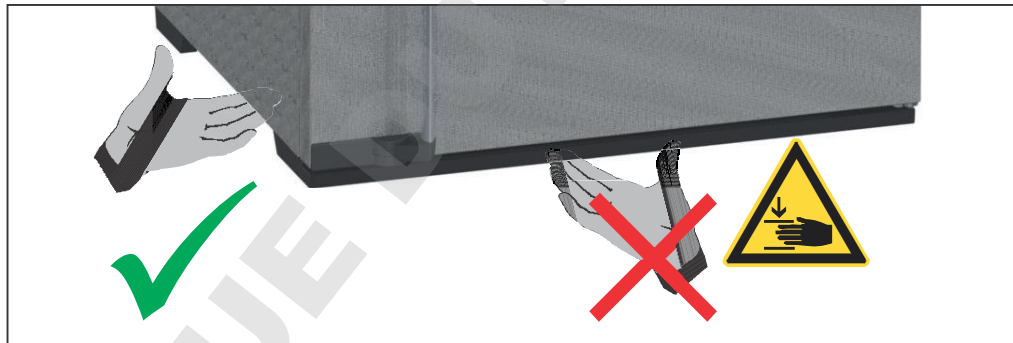

Warning!

The appliance could fall over and seriously injure you. Never tilt the appliance and transport it in upright position and without load only (except for standard accessories such as steel grids or shelves). Appliances with castors always have to be moved by two people.

3.2 Delivery

The appliance is packed in cardboard and is delivered on a wooden palette.

3.3 Transport

The appliance can be transported in three ways:

- ▶ With a forklift truck; move the forks of the truck entirely under the pallet
- ▶ On a manual pallet jack
- ▶ On its own castors, in case of the corresponding configuration, for which the catch on the (front) castors must be released

3.4 Unpacking

i To avoid damage, do not unpack the appliance until you reach the installation site.

Remove the cardboard packaging by pulling it upwards or carefully cutting along an edge.

3.4.1 Checking for completeness and transport damage

- ▶ Check the delivery note to ensure that the delivery is complete.
- ▶ Check the appliance for damage.

If you notice deviations from the delivery note, damage or irregularities, do not put the appliance into operation but inform the haulage company and the manufacturer.

3.4.2 Removing the transport protection

Remove the transport protection. It is located between the door hinge, door and frame and has to be removed after opening the door.

3.4.3 Disposing of packaging material

Dispose of the packaging material (cardboard, wood, foil) in accordance with the applicable disposal regulations for the respective material in your country.

3.5 Storage after delivery

If the appliance is first to be stored after delivery: Read the storage conditions from page 47.

3.6 Setting up



Warning!

Due to its centre of gravity, the appliance can fall over to the front and injure you or other people. Always attach the appliance to a wall with the tilt protection (see page 21). If this cannot be done due to space problems, do not operate the appliance and do not open the door. Contact the Memmert service team (see page 2).

3.6.1 Prerequisites

The installation site must be flat and horizontal and must be able to reliably bear the weight of the appliance (see Technical data on page 14). Do not place the appliance on a flammable surface.

Depending on the model (see nameplate), a 230 V, 115 V or 400 V power connection must be available at the installation site.

The distance between the wall and the rear of the appliance must be at least 15 cm. The clearance from the ceiling must not be less than 20 cm and the side clearance from walls or nearby appliances must not be less than 5 cm (Fig. 8). Sufficient air circulation in the vicinity of the appliance must be guaranteed at all times.

For appliances with castors, these need to be positioned in forward direction at all times.

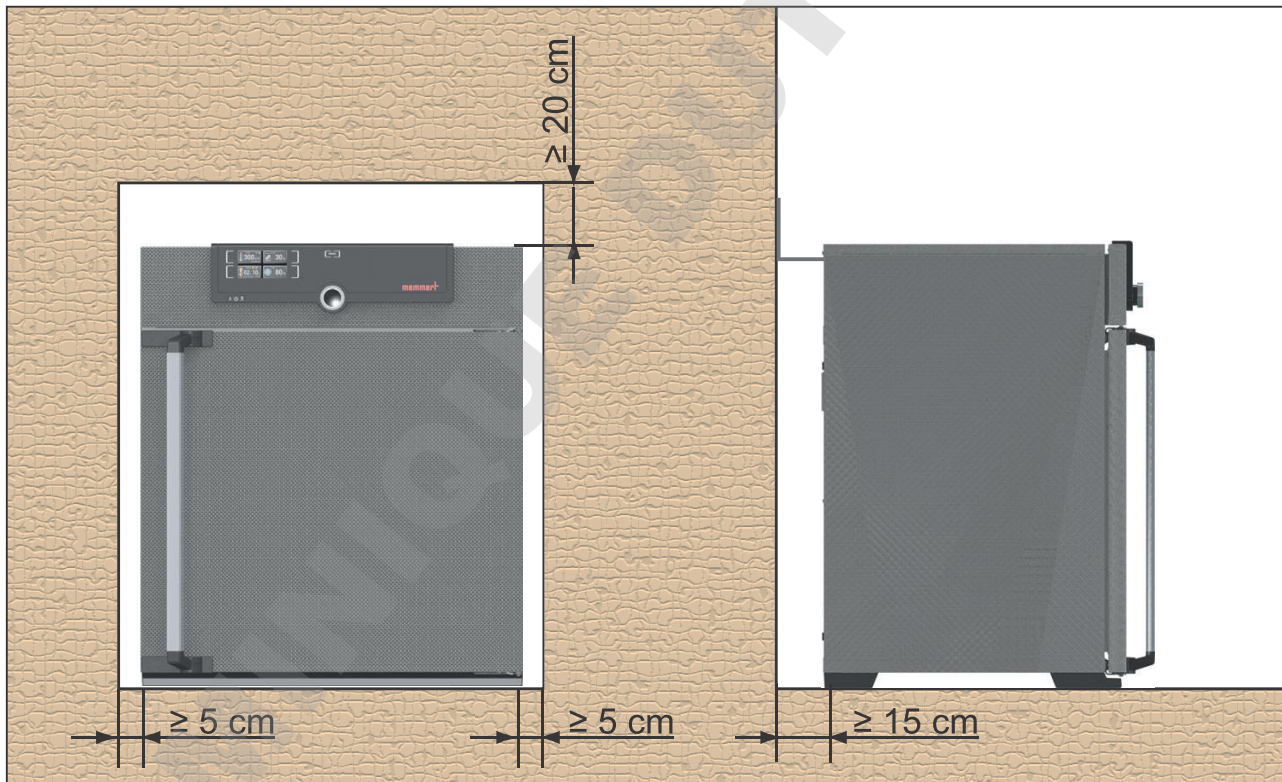









Fig. 8 Minimum clearance from walls and ceiling

3.6.2 Installation options

| Setting up | Comments | Suitable for appliance size ... | | | | | | | |
|---|--|---------------------------------|----|----|-----|-----|-----|-----|-----|
| | | 30 | 55 | 75 | 110 | 160 | 260 | 450 | 750 |
| Floor  | | ✓ | ✓ | ✓ | ✓ | ✓ | ✓ | ✓ | ✓ |
| Table  | Check the load capacity first | ✓ | ✓ | ✓ | ✓ | × | × | × | × |
| Stacked  | two appliances maximum; mounting material (feet) provided | ✓ | ✓ | ✓ | ✓ | × | × | × | × |
| Wall mounting  | Separately packaged fastening material is included in the scope of delivery. Observe the assembly instructions provided. | ✓ | ✓ | ✓ | ✓ | ✓ | × | × | × |
| Base  | with/without castors | ✓ | ✓ | ✓ | ✓ | ✓ | ✓ | ✓ | × |
| Castor frame  | | ✓ | ✓ | ✓ | ✓ | ✓ | ✓ | × | × |
| Height adjustable feet  | | ✓ | ✓ | ✓ | ✓ | ✓ | ✓ | ✓ | ✓ |

3.6.3 Tilt protection

Attach the appliance to a wall with the tilt protection. The tilt protection is included in the delivery.

1. As illustrated, fasten the tilt protection to the rear side of the appliance.
2. Bend the tilt protection upwards by 90 ° in the desired distance to the wall (consider the minimum distance to the wall, see Fig. 8).
3. Drill a hole, insert a plug and screw the tilt protection to a suitable wall.

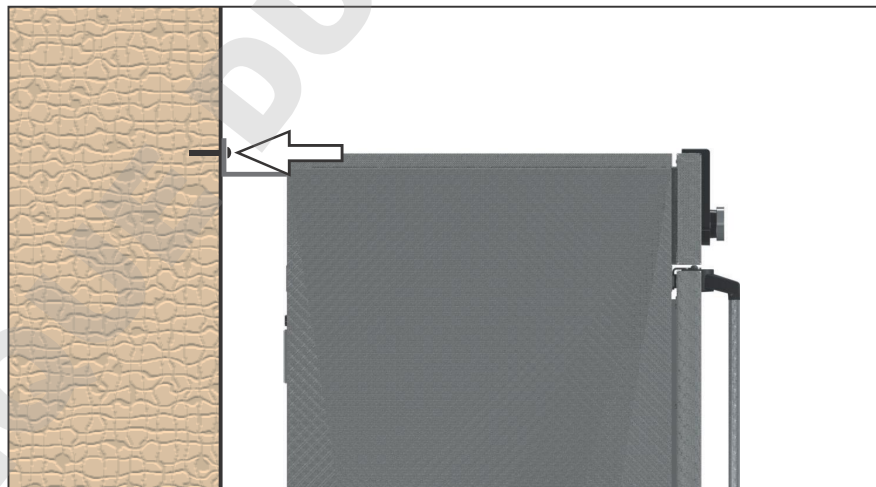
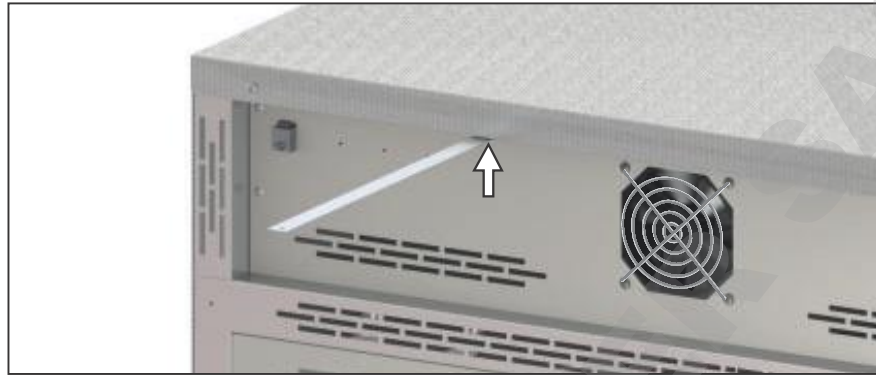

3.6.4 Adjusting the doors

For appliances it is possible to adjust doors that warp due to the floor conditions. In order to do so, every door has two adjuster screws at the top and at the bottom (Fig. 9).

● First, adjust the door at the top and then, if further adjustment is necessary, at the bottom as well.

1. Open the door.
2. Undo the screws.
3. Adjust the door.
4. Tighten the screws again.
5. Check door alignment.
6. If necessary, readjust.

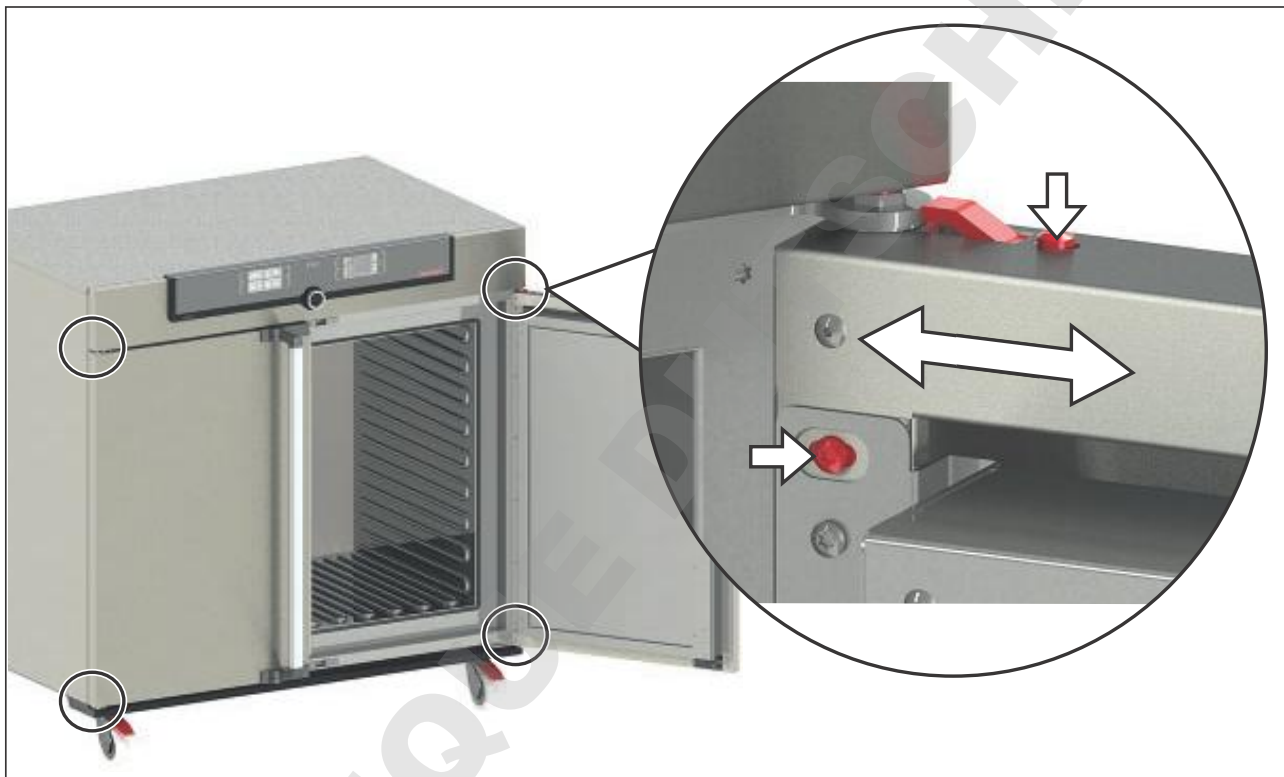

Fig. 9 Door adjustment screws

4. Putting into operation

Caution:
The first time the appliance is operated, it must not be left unattended until it has reached the steady state.

4.1 Connecting the appliance

⚠ WARNING



Condensation might cause a short circuit. After transport or storage at high humidity conditions, the appliance shall be stored unpacked at normal conditions for at least 24 hours. During this period of time the appliance shall not be connected to the power supply.

Caution:
Observe the country-specific regulations when making connections (e.g. in Germany DIN VDE 0100 with residual current circuit breaker). Observe the connection and power ratings (see nameplate and Technical data on page 14). Make sure to establish a safe PE conductor connection.

Lay the power cable so that

- ▶ it is always accessible and within reach so it can be disconnected quickly in the event of failure or emergencies;
- ▶ no one can trip over it;
- ▶ it does not come into contact with any hot parts.

230/115-V appliances:

Plug the provided power cable into the rear of the appliance and connect it to a CEE 7/4 socket (Fig. 10).

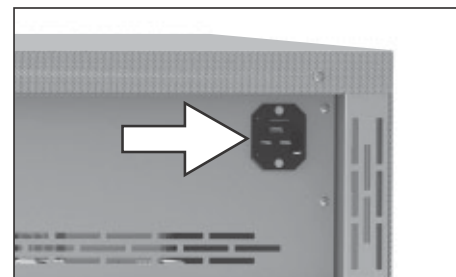

Fig. 10 Power connection
230/115 V

400V appliances:

The power cable is permanently installed. Connect the plug to a 400 V CEE coupling (Fig. 11).



Fig. 11 400 V CEE connection

4.2 Switching on

Switch on the appliance by pressing the On/Off switch on the front of the appliance (Fig. 12).

The starting process is shown by three animated white dots **●●●**. If the dots have another colour, an error has occurred (see page 34).

i After the first start-up, the appliance display is set to English by default. You can change the language as described from page 37. However, to get a basic overview of operating the appliance, you should read the following chapter first.

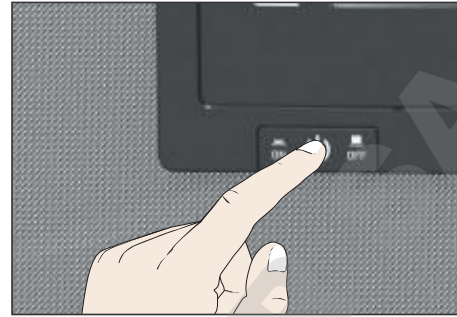

Fig. 12 Switch on appliance

5. Operation and control

5.1 Operating personnel

The appliance may only be operated by persons who are of legal age and have been instructed accordingly. Personnel who are to be trained, instructed or who are undergoing general training may only work with the appliance under the continuous supervision of an experienced person.

5.2 Opening the door

- ▶ To open the door, pull the door handle to the side (to the left or to the right, depending on the door variation, see Fig. 13, A) and open the door completely.
- ▶ To close the appliance, push the door closed and the door handle to the side (B).

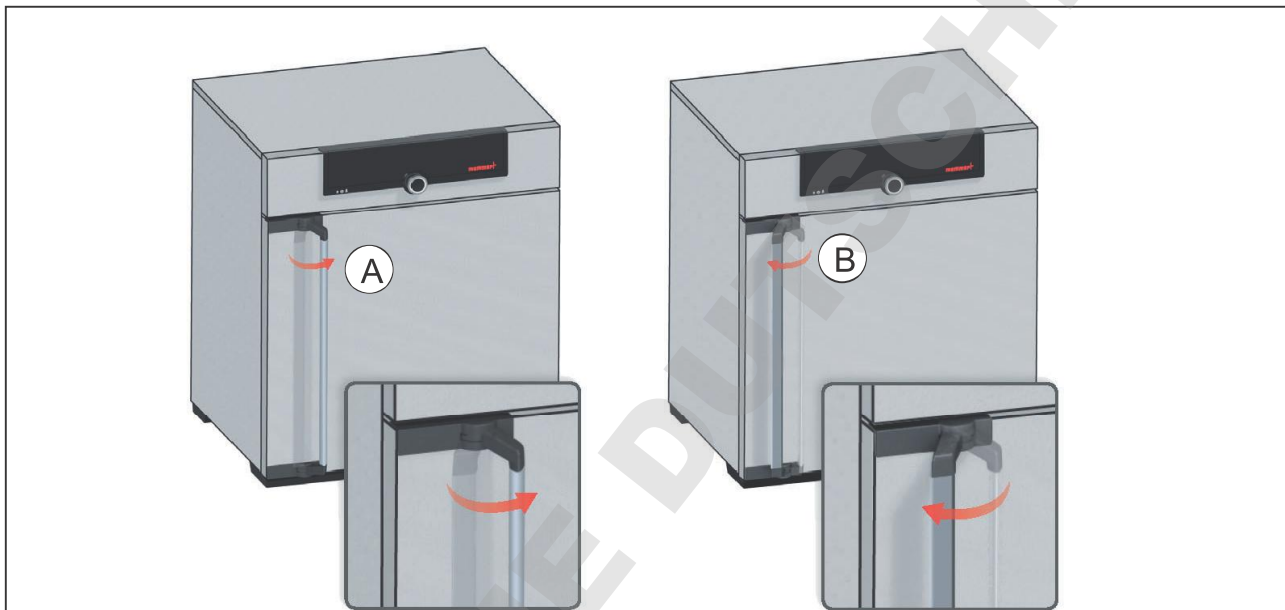

Fig. 13 Opening and closing the door



Warning!

If the door is open while the appliance is in operation, the appliance may overheat and pose a fire hazard. Do not leave the door open during operation.



Warning!

In case of appliances of a certain size, you can get accidentally locked in, which is life-threatening. Do not climb into the appliance!

5.3 Loading the appliance



Warning!

When loading the appliance with an unsuitable load, poisonous or explosive vapours or gases may be produced. This could cause the appliance to explode, and persons could be severely injured or poisoned. The appliance may only be loaded with materials which do not form any toxic or explosive vapours when heated up and cannot ignite (see also page 11). If there is any doubt as to the composition of materials, they must not be loaded into the appliance.



i Caution:
Check the chamber load for chemical compatibility with the materials of the appliance (see page 12).

i Caution:
If the chamber load is wet or very humid, water may accumulate on the floor and damage the heater. If wet, use a drip tray on the bottom of the tube.

Insert the sliding steel grids or sliding shelves. The maximum number of grids / shelves and the load capacity are specified in the technical data overview on page 14.

The chamber must not be loaded too tightly, so that proper air circulation in the working chamber is guaranteed. Do not place any chamber load on the floor, touching the side walls or right below the ceiling of the working chamber (Fig. 14, see also the "correct loading" sticker on the appliance).

In case of improper loading (chamber loaded too tightly), the set temperature may be exceeded or it may take longer until it is reached.

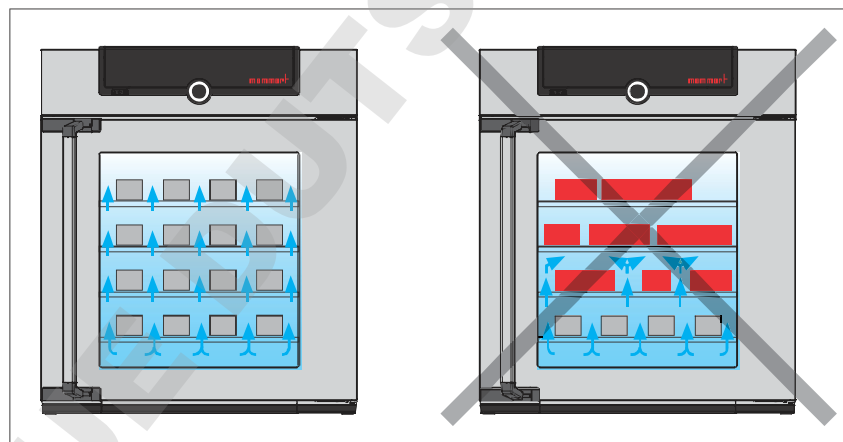

Fig. 14 Correct placement of the chamber load

i To achieve the correct heating capacity, the type of slide-in unit used – Grid or Shelf – must be set in the menu under **SETUP** (see page 41).

5.4 Operating the appliance

5.4.1 ControlCOCKPIT

In manual operation, the desired parameters are entered at the ControlCOCKPIT on the front of the appliance (Fig. 15 and Fig. 16). You can also make basic settings here (menu). Additionally, warning messages are displayed, e.g. if the temperature is exceeded.

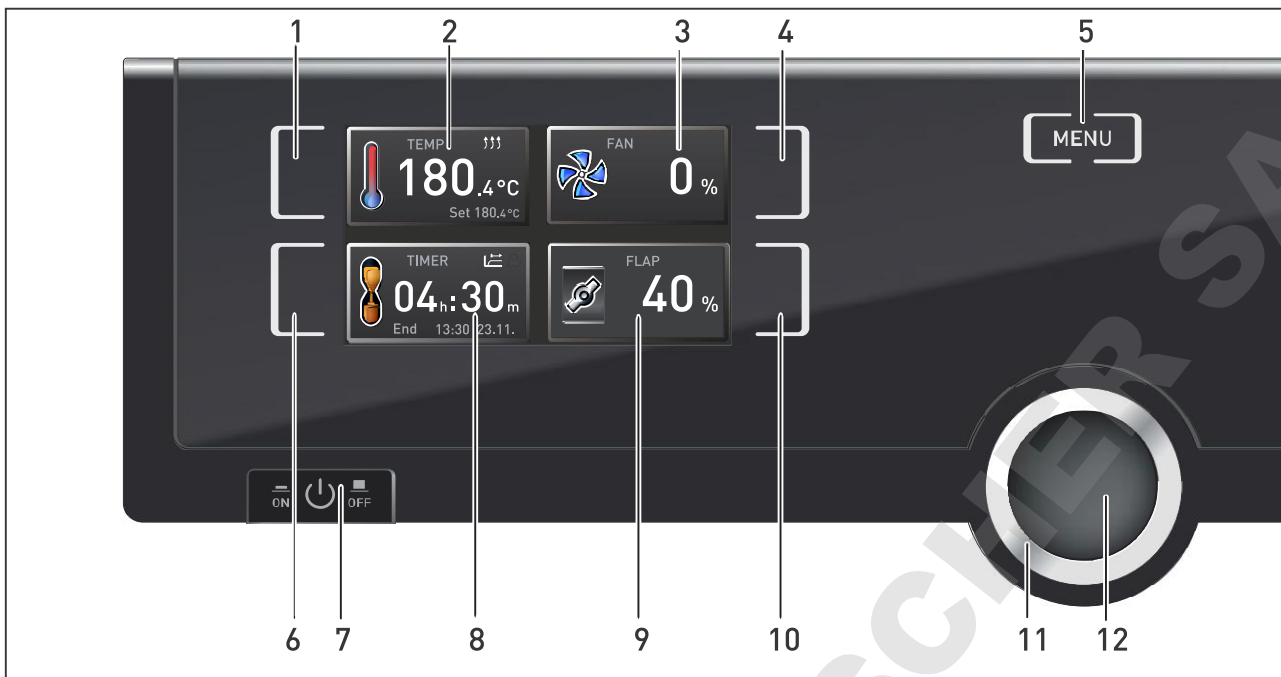

Fig. 15 ControlCOCKPIT for UF.../IF... appliances in operating mode

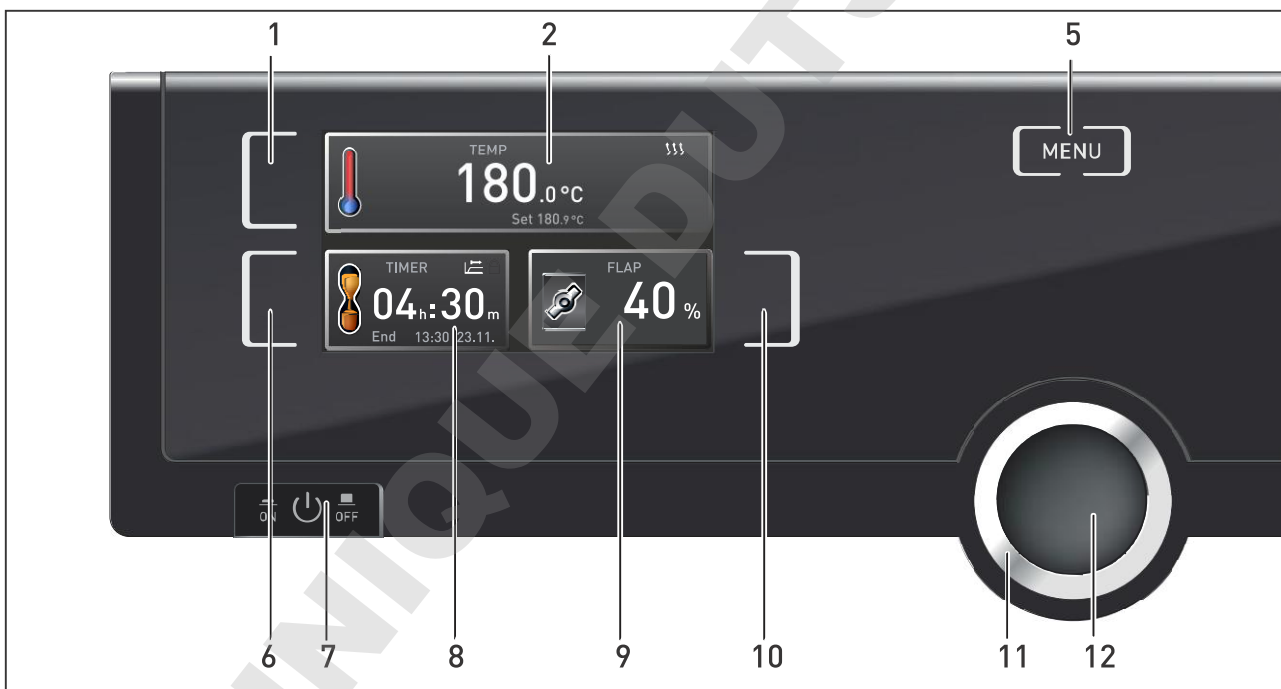

Fig. 16 ControlCOCKPIT for UN.../IN... appliances in operating mode

- | | |
|--|---|
| 1 Activation key for temperature setpoint adjustment | 8 Display digital backwards counter with target time setting, adjustable from 1 minute to 99 days |
| 2 Setpoint and actual temperature display | 9 Air flap position display |
| 3 Fan speed display | 10 Activation key for air flap position adjustment |
| 4 Activation key for fan speed setting | 11 Turn control for setpoint adjustment |
| 5 Switch to menu mode (see page 36) | 12 Confirmation key (accepts setting made with the turn control) |
| 6 Activation key digital backwards counter with target time setting, adjustable from 1 minute to 99 days | |
| 7 On/Off switch | |

5.4.2 Basic operation

In general, all settings are made according to the following pattern:

1. Activate the desired parameter (e.g. temperature). To do so, press the corresponding activation key on the left or right of the respective display. The activated display is lined in colour, the other displays are dimmed. The set value is highlighted in colour.

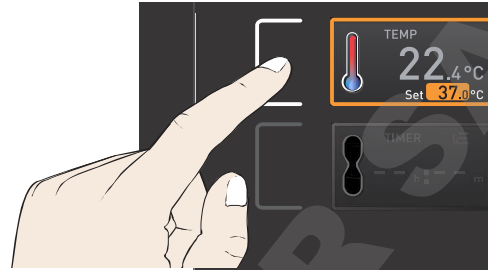

2. By turning the turn control to the left or right, adjust the set value (e.g. to 180.0 °C).

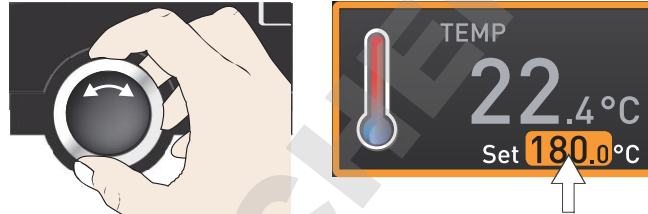

3. Save the set value by pressing the confirmation key. The display returns to normal and the appliance begins adjusting to the defined set value.

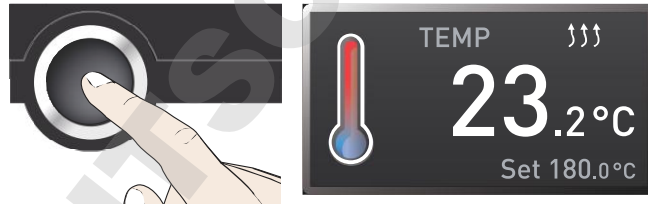

Additional parameters (air flap position etc.) can be set accordingly.

i If no new values are entered or confirmed for approx. 30 seconds, the appliance automatically returns to the main menu and restores the former values.

If you want to cancel the setting procedure, press the activation key on the left or right of the display that you want to exit. The appliance restores the former values. Only the settings that you have confirmed by pressing the confirmation key before cancelling the setting procedure are accepted.



5.4.3 Operating modes

The appliance can be operated in different modes:

- ▶ **Manual mode:** The appliance runs in permanent operation at the values set on the ControlCOCKPIT. Operation in this mode is described in chapter 5.4.4.
- ▶ **Operation with digital backwards counter with target time setting, adjustable from 1 minute to 99 days (Timer):** The appliance runs at the values set until the timer has elapsed. Operation in this mode is described in chapter 5.4.5.
- ▶ via remote control (see page 41)

5.4.4 Manual mode

In this operating mode, the appliance runs in permanent operation at the values set on the ControlCOCKPIT.

Adjustment options

As described in chapter 5.4.2, you can set the following parameters after pressing the corresponding activation key (in any sequence):

Temperature

Adjustment range: model dependent (see nameplate and technical date on page 14)

- Heating operation is indicated by the $\uparrow\uparrow\uparrow$ symbol.
- i You can select °C or °F as the temperature unit displayed (see page 39).

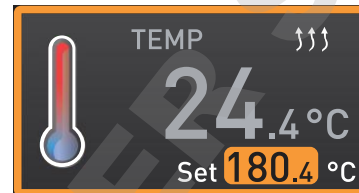

Air flap position

Adjustment range: 0 % (closed, recirculating operation) to 100 % (completely opened, fresh air operation) in steps of 10%

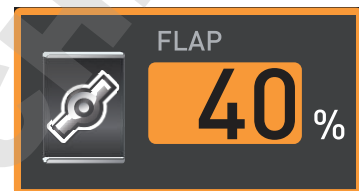

Fan speed

(only for UF.../IF... appliances)

Adjustment range: 0 to 100 % in steps of 10%



5.4.5 Operation with digital backwards counter with target time setting, adjustable from 1 minute to 99 days (Timer)

In timer operation, you can adjust the time the appliance runs at the set value.

1. Press the activation key to the left of the timer display. The timer display is activated.

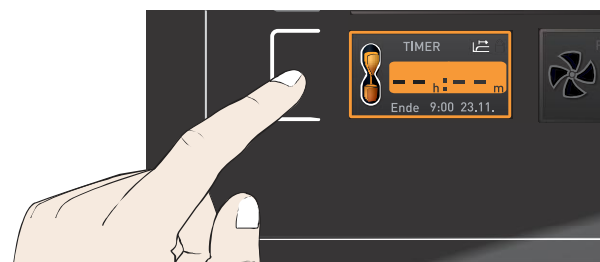

2. Turn the turn control until the desired duration is displayed – in this example 4 hours 30 minutes. The approximate end time is shown beneath, in a smaller font.

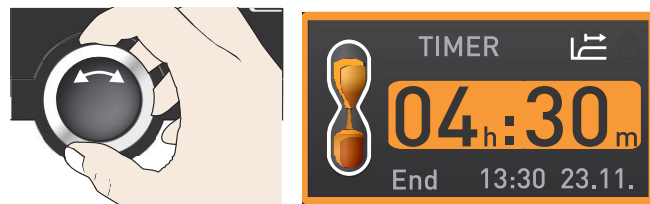

- i Up to a duration of 23 hours 59 minutes, the time is displayed in hh:mm (hours:minutes) format. For 24 hours and more, the format dd:hh (days:hours) is used. The maximum duration adjustable is 99 days 00 hours.

3. Press the confirmation key.

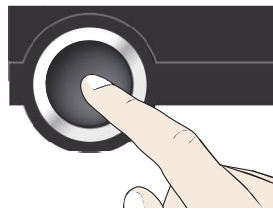

The display now shows the remaining time in a large font and the approximate end time in a smaller font beneath.



4. Now, as described under 5.4.2, set the individual values for temperature, air flap position etc. which you want the appliance to operate at. The set values can be changed at any time while the timer elapses. The changes are effective immediately.

i In Setup, you can choose if the timer should run setpoint-dependent or not. This determines whether the timer should not start until a tolerance band around the set temperature is reached or whether it should start right after activation (see page 41). If the timer runs setpoint-dependent, this is indicated by the  symbol in the timer display.

When the timer has elapsed, the display shows 00h:00m. All functions (heating etc.) are switched off. If a fan had been active, it will keep on running for a short safety period. In addition, an acoustic alarm sounds, which can be turned off by pressing the confirmation key.

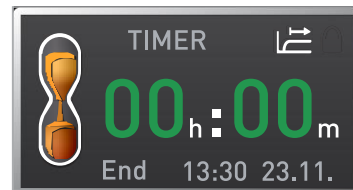

To deactivate the timer, open the timer display by pressing the activation key again and then turning the turn control to reduce the timer setting until --:-- is displayed. Confirm with the confirmation key.

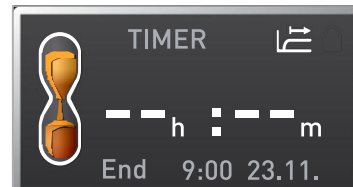

5.5 Temperature monitoring

The appliance is equipped with a double overtemperature protection (mechanical/electronic) in accordance with DIN 12 880. This serves to avoid damage to the chamber load and/or appliance in case of a malfunction:

- ▶ Electronic temperature monitoring (TWW/TWB) (TWB only if equipped with a second temperature sensor, option A6)
- ▶ mechanical temperature limiter (TB)

5.5.1 Electronic temperature monitoring

The monitoring temperature of the electronic temperature monitoring is measured via the Pt100 temperature sensor in the interior of the chamber. The type of temperature monitoring (TWW/TWB) and the monitoring temperature are set in menu mode in the Setup display (see page 40). The setting made applies to all operating modes.

If the manually set monitoring temperature is exceeded, temperature monitoring takes over temperature control and begins to regulate the monitoring temperature (TWW, Fig. 17) or switches off the heating (TWB, Fig. 18).

i The two types of temperature monitoring are only available for appliances equipped with a second temperature sensor (option A6). For appliances with only one temperature sensor, only TWW is available.

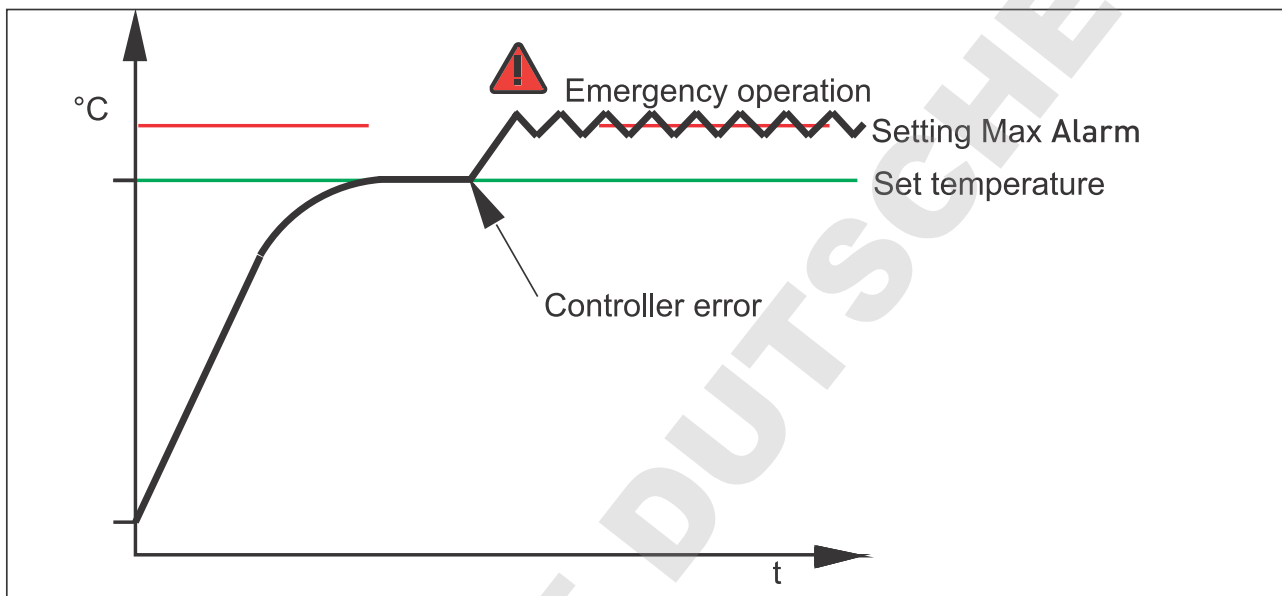

Fig. 17 Schematic diagram of how the TWW temperature monitoring system works

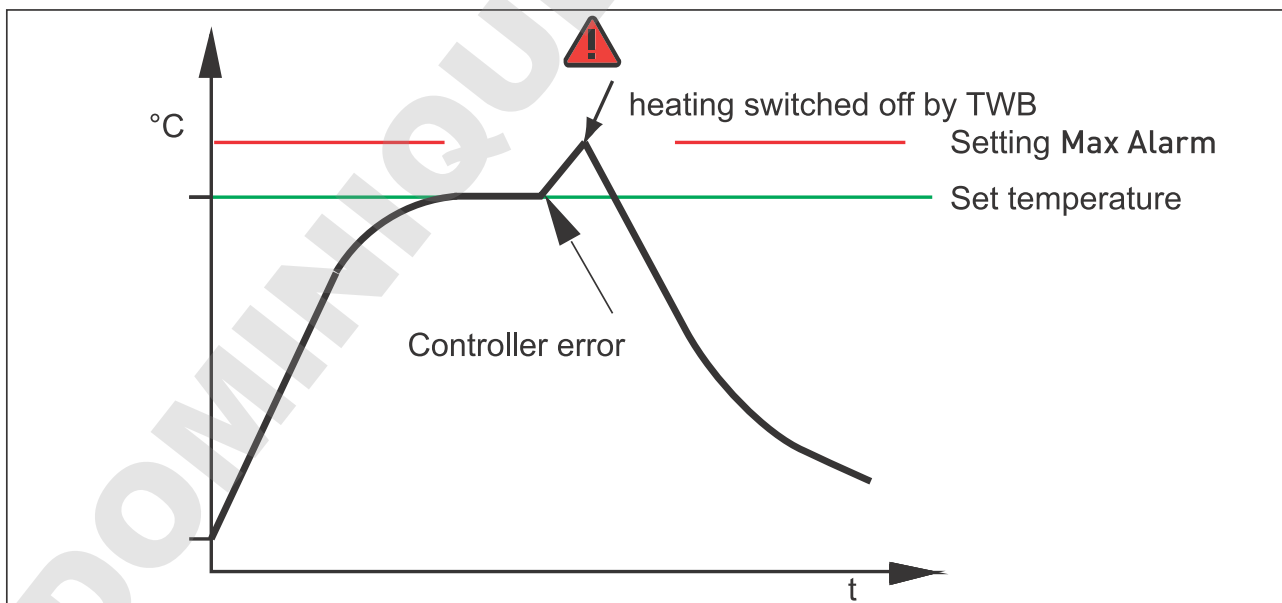



Fig. 18 Schematic diagram of how the TWB temperature monitoring works (only if equipped with a second temperature sensor, option A6)

5.5.2 Mechanical temperature monitoring: Temperature limiter (TB)

The appliance is equipped with a mechanical temperature limiter (TB) of protection class 1 in accordance with DIN 12 880.

If the electronic monitoring unit should fail during operation and the factory-set maximum temperature is exceeded by approx. 20 °C, the temperature limiter, as the final protective measure, switches off the heating permanently.

5.5.3 Function

If temperature monitoring has been triggered, this is indicated by the temperature display: the actual temperature is highlighted in red and a warning symbol  is shown (Fig. 19). The type of temperature monitoring triggered is shown beneath the temperature: TB for mechanical and TWW or TWB for electronic temperature monitoring. The alarm is additionally signalled by an intermittent acoustic signal, which can be turned off by pressing the confirmation key. Information on what to do in this case are provided in the chapter Malfunctions, warning and error messages from page 33.

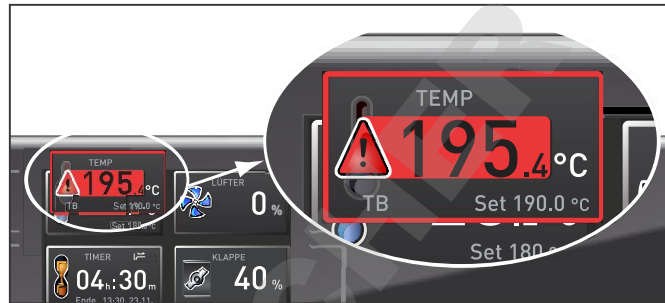

Fig. 19
Temperature monitoring triggered

5.6 Ending operation



Warning!

Depending on the operation performed, the surfaces in the working chamber and the chamber load may still be very hot after the appliance is switched off. Touching these surfaces can cause burns. Wear heat-resistant protective gloves or wait until the appliance cools down.

1. Switch off active appliance functions (turn back the set values).
2. Remove the chamber load.
3. Switch off the appliance (Fig. 20).

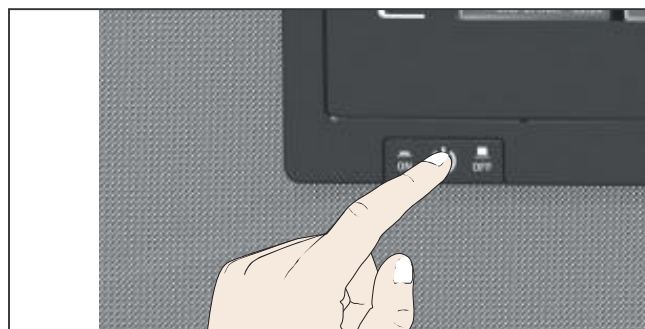

Fig. 20 Switch off appliance

6. Malfunctions, warning and error messages



Warning!

After removing covers, live parts may be exposed. You may receive an electric shock if you touch these parts. Malfunctions requiring work inside the appliance may only be rectified by electricians. Observe the separate service manual for this.

Do not try to rectify appliance errors yourself but contact the MEMMERT customer service department (see page 2) or an authorised service point.

In case of enquiries, please always specify the model and appliance number from the nameplate (see page 13).

6.1 Warning messages of the temperature monitoring function

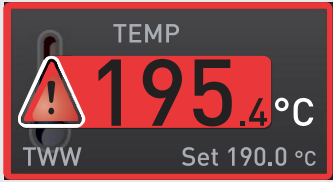
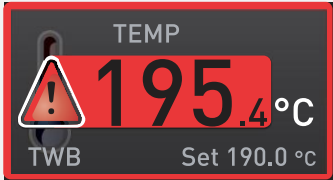
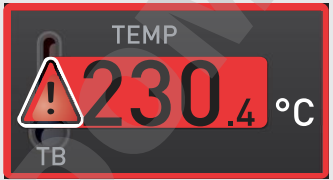
| Description | Cause | Action | See |
|--|---|---|---------------------------|
| Temperature alarm and "TWW" are displayed  | The adjustable undertemperature / overtemperature controller (TWW) has assumed heating control. | Increase the difference between the monitoring and setpoint temperature – by either increasing the max value of the temperature monitoring (MAX temp) or decreasing the setpoint temperature. If the alarm continues: Contact customer service | page 40 page 2 |
| Temperature alarm and "TWB" are displayed  | The electronic temperature limiter (TWB) permanently switched off heating. | Deactivate the alarm by pressing the confirmation key. Increase the difference between the monitoring and setpoint temperature – by either increasing the max value of the temperature monitoring (MAX temp) or decreasing the setpoint temperature. If the alarm continues: Contact customer service | page 40 page 2 |
| Temperature alarm and TB are displayed  | The mechanical temperature limiter (TB) permanently switched off heating. | Switch off the appliance and leave to cool down. Contact customer service and have the error rectified (e.g. by replacing the temperature sensor). | page 2 |

6.2 Malfunctions, operating problems and appliance errors

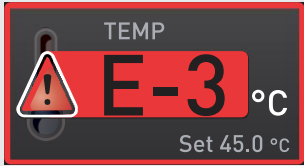
| Error description | Cause of errors | Rectifying errors | See |
|--|--|--|---------|
| Displays are dark | External power supply was interrupted | Check the power supply | page 23 |
| | Miniature fuse, appliance fuse or power module faulty | Contact customer service | page 2 |
| Individual or all displays cannot be activated | The appliance is in timer or remote control mode (mode "Write" or "Write + Alarm") | Wait until the end of the timer or switch off the remote control | |
| Displays suddenly look different | Appliance is in "wrong" mode | Change to operating or menu mode by pressing the MENU key | |
| Error message E-3 in the temperature display  | Temperature sensor defective. | <ul style="list-style-type: none"> ▶ Switch off appliance. ▶ Remove the chamber load ▶ Contact customer service | page 2 |
| When switching on the appliance, the start animation is displayed in another colour than white ●●● | ▶ Cyan ●●●: Not enough storage space on the SD card | Contact customer service | page 2 |
| | ▶ Red ●●●: The system files could not be loaded | Contact customer service | page 2 |
| | ▶ Orange ●●●: The fonts and images could not be loaded | Contact customer service | page 2 |

6.3 Power failure

**Warning!**

Depending on the operation performed, the surfaces in the interior and the chamber load may still be very hot after power loss. Additionally, depending on the duration of the power loss, the appliance might heat up again after power supply has been restored (see below). Touching these surfaces can cause burns. Wear heat-resistant protective gloves or wait until the appliance cools down first.



In case of a power failure, the appliance operates as follows:

In manual mode

After power supply has been restored, operation is continued with the parameters set. The time and the duration of the power failure is documented in the protocol log memory.

In timer mode

In case of an interruption of the power supply of less than 60 minutes, the current timer is continued from the point at which it was interrupted. For interruptions of the power supply longer than this, all appliance functions (heating, fan etc.) are switched off and the air flap is opened.

In remote control mode:

The previous values are restored.

7. Menu mode

In menu mode, you can make basic settings as well as adjust appliance parameters.

i Caution:

Before changing menu settings, read the description of the respective functions on the following pages to avoid possible damage to the appliance and/or chamber load.

To enter menu mode, press the MENU key.

i To exit the menu mode at any time, press the MENU key again. The appliance then returns to manual mode. Only changes accepted by pressing the confirmation key are saved.

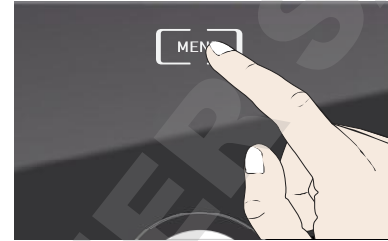

7.1 Overview

Press the MENU key to change between the displays in menu mode:

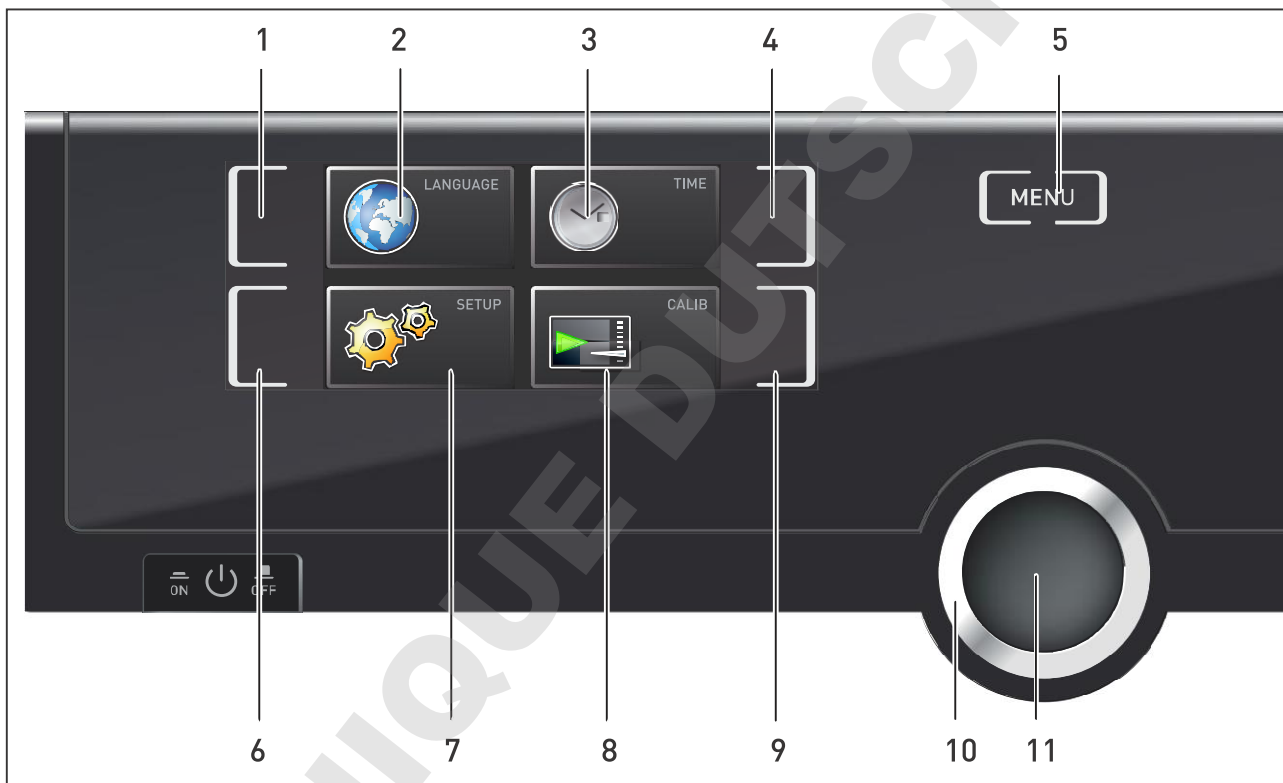

Fig. 21 ControlCOCKPIT in menu mode

- | | |
|---|--|
| 1 Language selection activation key | 7 Setup display (basic appliance settings) |
| 2 Language selection display | 8 Adjustment display |
| 3 Date and time display | 9 Adjustment activation key |
| 4 Date and time setting activation key | 10 Turn control for adjustment |
| 5 Return to manual mode | 11 Confirmation key (accepts setting made with the turn control) |
| 6 Setup activation key (basic appliance settings) | |

7.2 Basic operation in menu mode using the example of language selection

In general, all settings in menu mode are done just like in manual mode: Activate the respective display, use the turn control for setting and press the confirmation key to accept the change. A more detailed description is provided in the following, using the example of language selection.

1. Activate the desired parameter (in this example the language). To do so, press the corresponding activation key on the left or right of the respective display. The activated display is enlarged.



- i** If you want to exit or cancel your settings, again press the activation key which you have used to activate the display. The appliance returns to the menu overview. Only the settings that you have confirmed by pressing the confirmation key before cancelling the setting procedure are accepted.

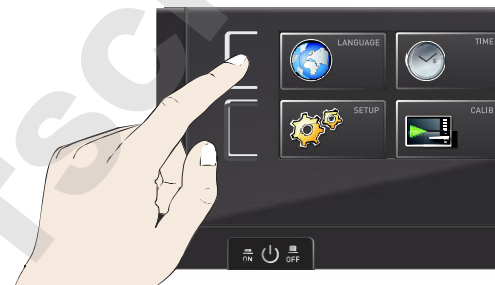

2. With the turn control, select the desired new setting, e.g. Español (Spanish).

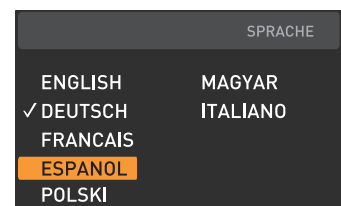

3. Save the setting by pressing the confirmation key.

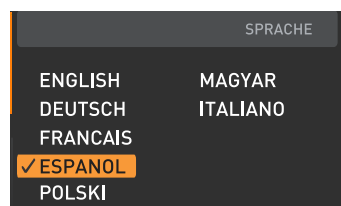
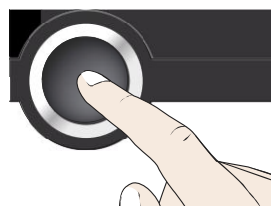

4. To return to the menu overview, press the activation key again.



You can now

- ▶ activate another menu function by pressing the corresponding activation key or
- ▶ return to manual mode by pressing the MENU key.

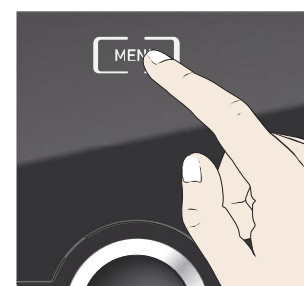
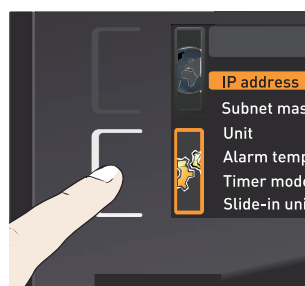

All other settings can be made accordingly. The settings possible are described in the following sections.

i If no new values are entered or confirmed for approx. 30 seconds, the appliance automatically returns to the main menu and restores the former values.

7.3 Setup

In the SETUP display, you can set the following parameters:

- ▶ the IP address and Subnet mask of the appliance's Ethernet interface (for connection to a network)
- ▶ the Unit of the temperature display (°C or °F, see page 39)
- ▶ the type of temperature monitoring (TWW or TWB, Alarm Temp, only if equipped with a second temperature sensor, option A6) and the trigger temperature of the monitoring function (Max alarm, see page 40)
- ▶ how the digital backwards counter with target time setting works (Timer mode, see page 41)
- ▶ the type of the slide-in unit (Grid or Shelf, see page 41)
- ▶ Remote control (see page 41)
- ▶ Gateway (see page 42)

i If the SETUP menu contains more entries than can be displayed, this is indicated by the display "1/2". This means that there is a second „page“ of entries.

To display the hidden entries, use the turn control to scroll beyond the lowest entry. The page display changes to "2/2".

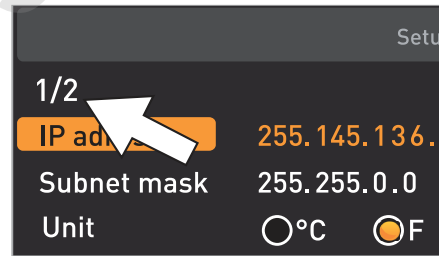

7.3.1 IP address and subnet mask

If you want to operate one or more appliances in a network, each appliance must have its own unique IP address for identification. By default, each appliance is delivered with the IP address 192.168.100.100.

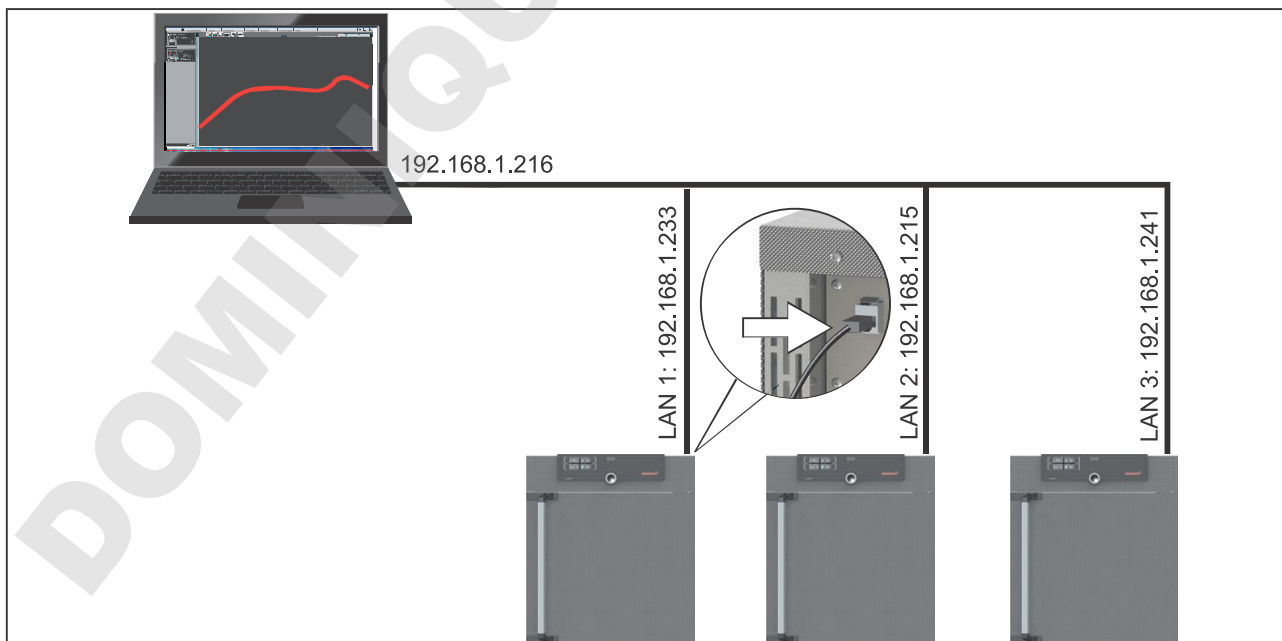
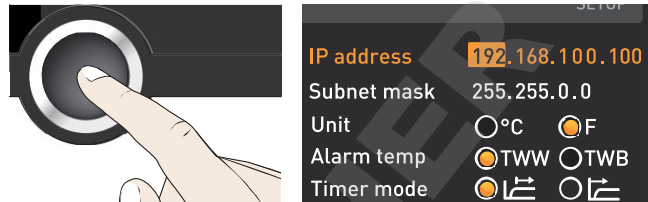

Fig. 22 Operation of several appliances in a network (schematic example)

1. Activate the SETUP display. The entry IP address is automatically highlighted.



2. Accept the selection by pressing the confirmation key. The first three digits of the IP address are automatically selected.



3. With the turn control, set the new number, e.g. 255.



4. Accept the selection by pressing the confirmation key. The next three digits of the IP address are automatically selected. Setting these is done with the turn control according to the description above.

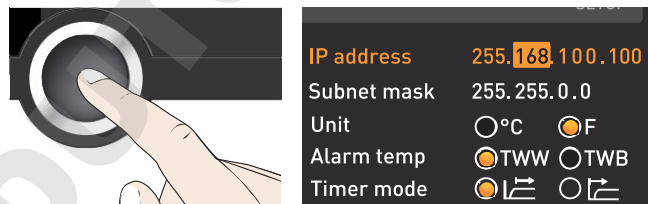

5. After setting the last three digits, accept the new IP address by pressing the confirmation key. The selection returns to the overview.

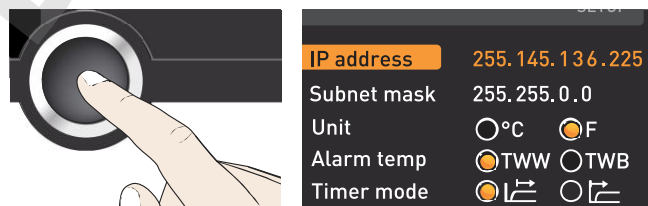

The subnet mask is set accordingly.

7.3.2 Unit

Here, you can choose whether the temperature is displayed in °C or °F.

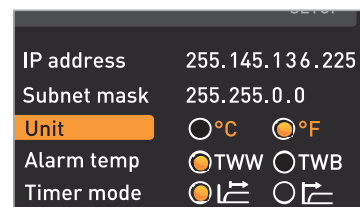

7.3.3 Temperature monitoring (Alarm Temp and Max Alarm)

Here, the type of monitoring function that should be activated (TWW or TWB, description from page 30) can be set (Alarm Temp), as well as the temperature at which the automatic temperature monitoring should be triggered (Max alarm).

- The selection option TWW/TWB is only available for appliances with a second temperature sensor (option A6).

- The monitoring temperature must be set sufficiently high above the maximum set temperature. We recommend 5 to 10 K difference for UN../UF... and 1 to 3 K difference for IN../IF...

1. Activate the SETUP display and select Alarm temp with the turn control.

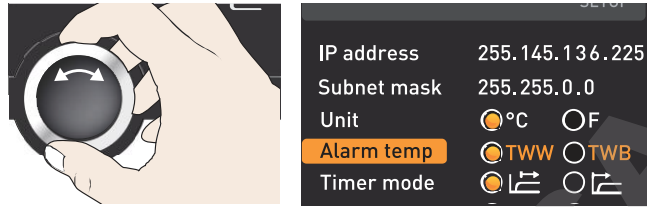

2. Accept the selection by pressing the confirmation key. The adjustment options are automatically highlighted.

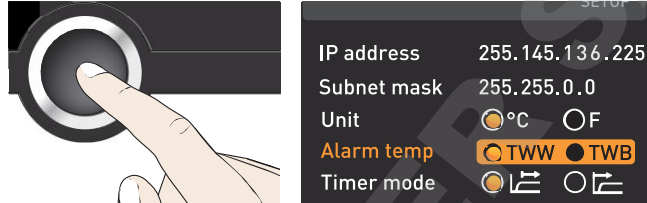

3. With the turn control, select the desired setting – in this example TWB.



4. Save the setting by pressing the confirmation key.

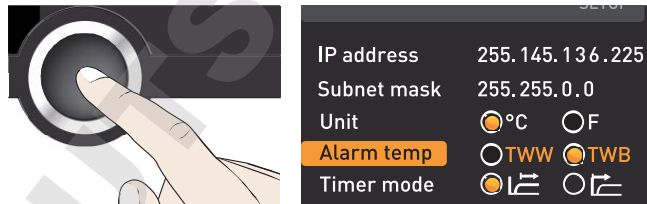

5. Select Max Alarm with the turn control.

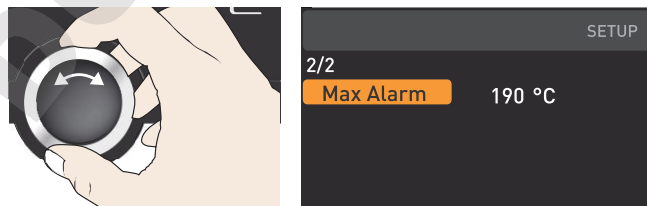

6. Accept the selection by pressing the confirmation key. The current settings are automatically highlighted.



7. With the turn control, select the desired new trigger temperature - in this example 160 °C.

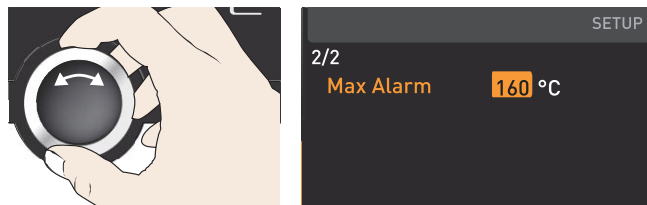

8. Save the setting by pressing the confirmation key. The electronic temperature monitoring system will now be triggered when the actual temperature reaches 160 °C.

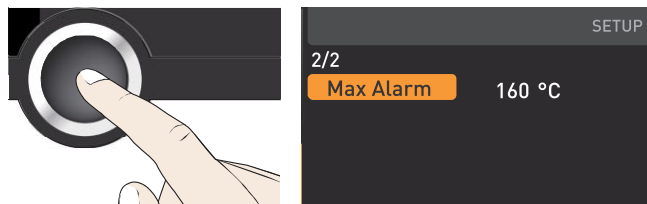

7.3.4 Timer Mode

Here, you can choose whether the digital backwards counter with target time setting (see page 29, timer) should run setpoint-dependent or not – this determines whether the timer should not start until a tolerance band of ± 3 K around the set temperature is reached (Fig. 23, B) or whether it should start right after activation (A).

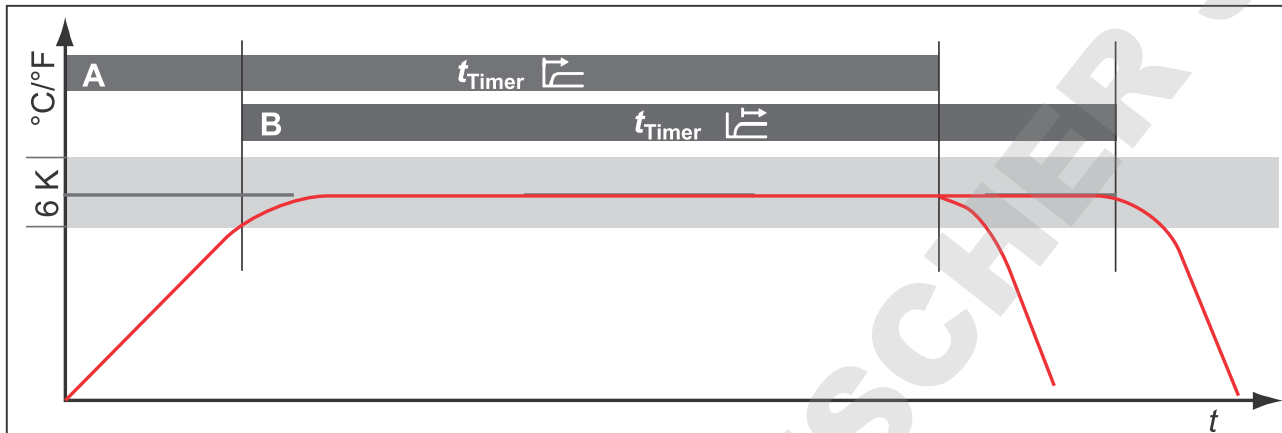
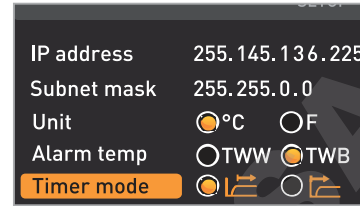

Fig. 23 Timer Mode

A Timer independent of setpoint: Timer starts right after activation

B Timer setpoint-dependent: Timer does not start until tolerance band is reached

If the temperature tolerance band is exceeded in setpoint-dependent operation, the timer will be interrupted and only be resumed when the setpoint temperature has been reached again.

7.3.5 Type of the slide-in unit (Grid or Shelf)

Here, you have to set the type of the slide-in unit (grid or shelf) used. The selection Shelf enables you to adjust the control function to the different air flow characteristics in the interior when using optional sliding shelves instead of the grids that are part of the standard delivery.

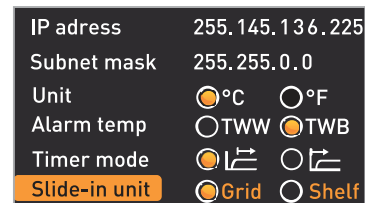

7.3.6 Remote control

In the setup entry Remote control, you can set whether the appliance should be controlled via remote control and if so, in which mode. These settings are available:

- ▶ Off
- ▶ Read Only
- ▶ Write + Read
- ▶ Write + Alarm

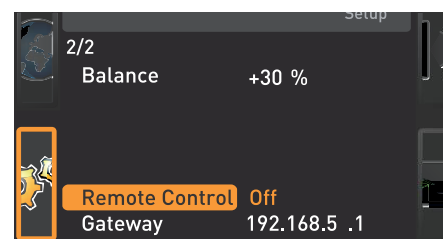

When the appliance is in remote control mode, the  symbol appears in the temperature display. In the settings Write + Read and Write + Alarm, the appliance cannot be controlled at the ControlCOCKPIT until the remote control has been switched off (setting Off) or set to Read Only.

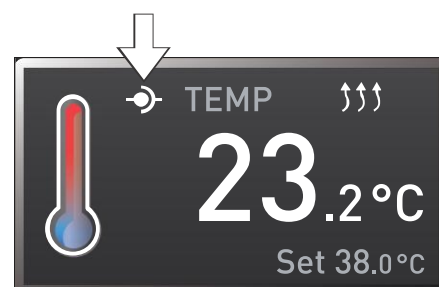

i In order to use the remote control function, programming skills and special libraries are required.

7.3.7 Gateway

The setup entry Gateway is used to connect two networks with different protocols.

The gateway is set the same way as the IP address (see page 38).

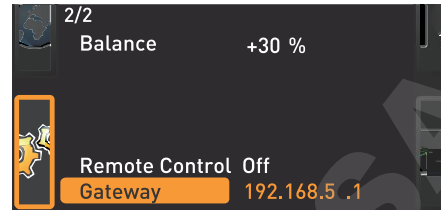

7.4 Date and Time

In the Time display, you can set date and time, time zone and daylight saving time. Changes can only be made in manual operating mode.

- i** Always set the time zone (and summer time yes/no) before you set the date and time.
- i** Avoid changing the set time after that since this can lead to gaps or overlapping when recording measured values. If you still need to change the time, you should not run a programme immediately before or after doing so.

1. Activate the time setting. To do so, press the activation key on the right side of the Time display. The display is enlarged and the first adjustment option (Date) automatically highlighted.

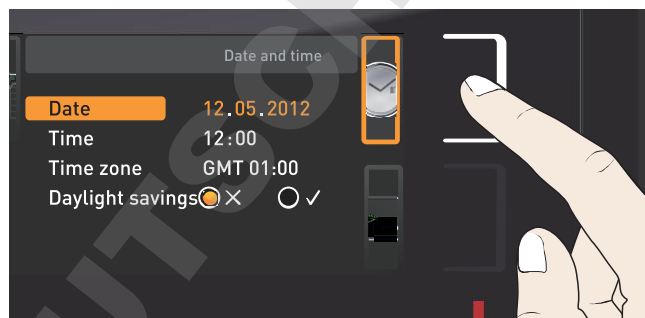

2. Turn the turn control until Time zone is highlighted.

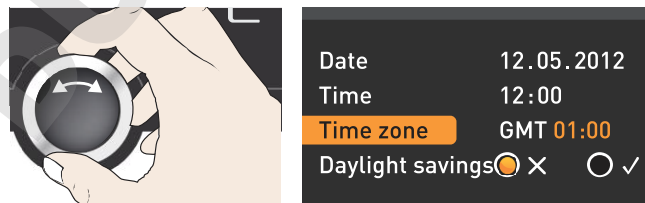

3. Accept the selection by pressing the confirmation key.



4. Set the time zone of the installation site with the turn control, e.g. 00:00 for Great Britain, 01:00 for France, Spain or Germany. Accept the selection by pressing the confirmation key.

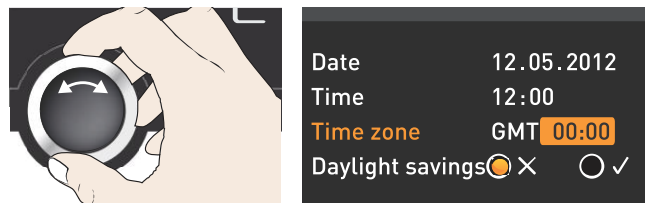

5. With the turn control, select the Daylight savings entry

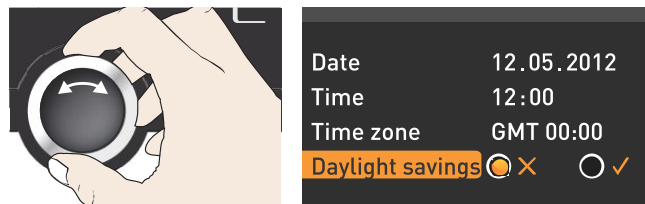

6. Accept the selection by pressing the confirmation key. The adjustment options are highlighted.

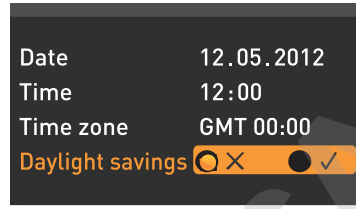
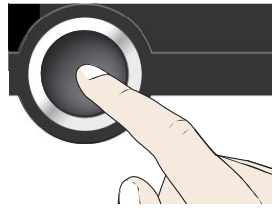

7. Set daylight savings to off (X) or on (✓) with the turn control – in this case on (✓). Save the setting by pressing the confirmation key.

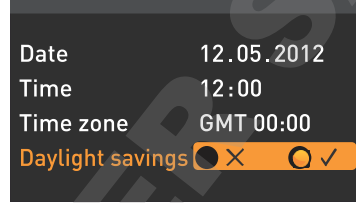

i Daylight saving time and standard time are not changed automatically. For this reason, please keep in mind to adjust them at the beginning of each period.

8. Now, set date (day, month year) and time (hours, minutes) in the same way. Accept the selection by pressing the confirmation key.

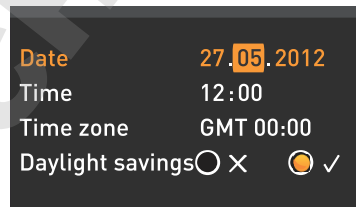

7.5 Calibration

The appliances are temperature calibrated and adjusted at the factory. In case readjustment should be necessary later on – for example due to influence of the chamber load – the appliance can be calibrated customer-specifically using three calibration temperatures of your choice:

- ▶ Cal1 Temperature calibration at low temperature
- ▶ Cal2 Temperature calibration at medium temperature
- ▶ Cal3 Temperature calibration at high temperature

To guarantee perfect control, we recommend to calibrate the appliance once a year.

i For temperature adjustment, you will need a calibrated reference measuring device.

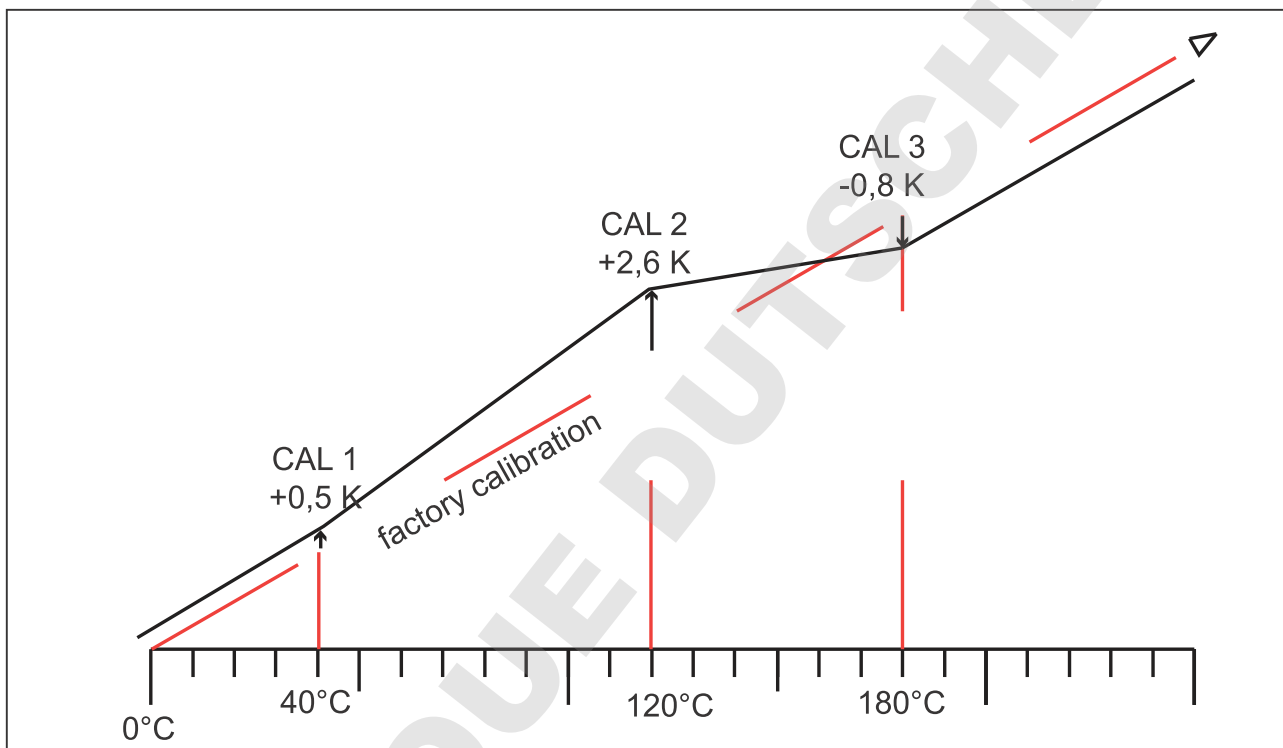
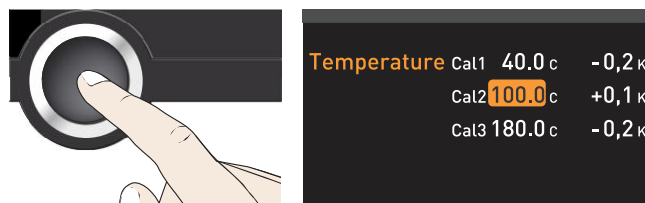
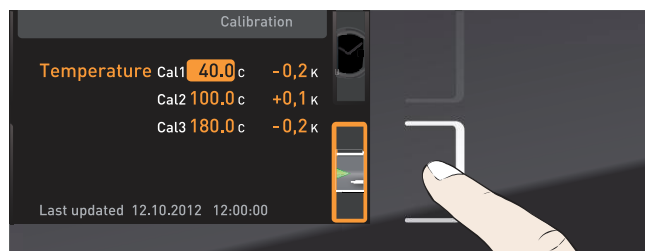

Fig. 24 Schematic example of temperature adjustment

Example: Temperature deviation at 120 °C should be corrected.

1. Activate the adjustment setting. To do so, press the activation key on the right side of the CALIB display. The display is enlarged and the first calibration temperature – in this case 40 °C – automatically highlighted.
2. Press the confirmation key repeatedly, until the calibration temperature Cal2 is selected.



3. With the turn control, set the calibration temperature Cal2 to 120 °C.

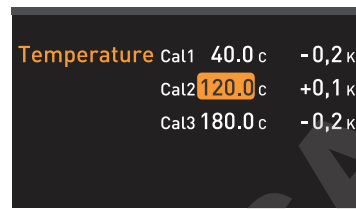
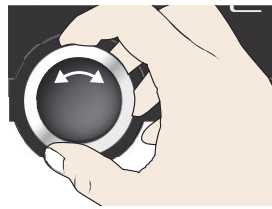

4. Save the setting by pressing the confirmation key. The corresponding calibration value is automatically highlighted.

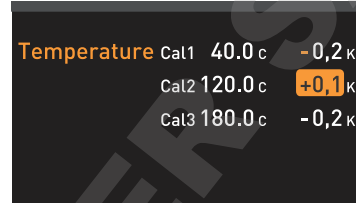
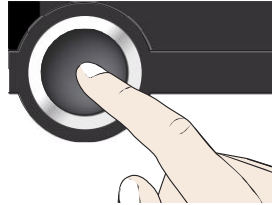

5. Set the calibration value to 0.0 K and accept the setting by pressing the confirmation key.

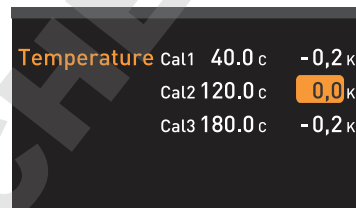

6. Position the sensor of a calibrated reference instrument centrally in the appliance's working chamber.

7. Close the door and, in manual mode, adjust the set temperature to 120 °C.

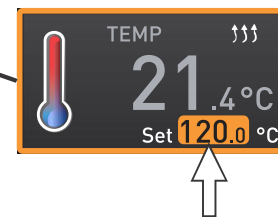
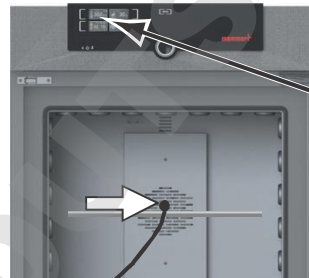

8. Wait until the appliance reaches the set temperature and displays 120 °C. The reference instrument for example displays 122.6 °C.

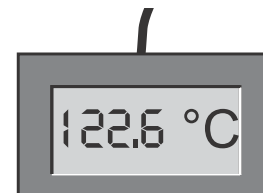
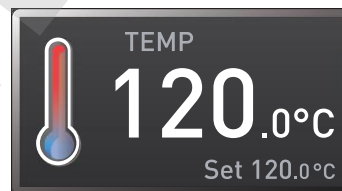

9. In the SETUP, adjust the calibration value Cal2 to +2.6 K (actual value measured minus setpoint temperature) and save the setting by pressing the confirmation key.

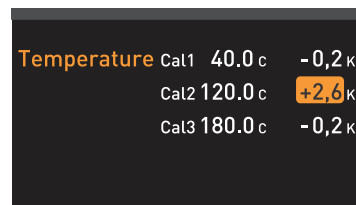

10. After the calibration procedure, the temperature measured by the reference instrument should now also be 120 °C.

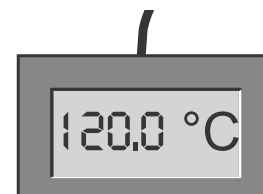
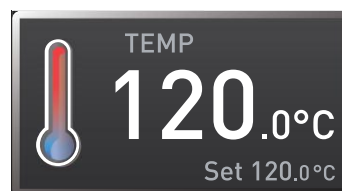

With Cal1, a calibration temperature below Cal2 can be programmed accordingly, and with Cal3, a temperature above. The minimum difference between the Cal values is 20 K for universal ovens UN.../UF... and 10 K for incubators IN.../IF...

i If all calibration values are set to 0.0 K, the factory calibration settings are restored.

8. Maintenance and service

8.1 Cleaning



Warning!

Danger due to electric shock. Before doing any maintenance work, pull out the mains plug.



Warning!

In case of appliances of a certain size, you can get accidentally locked in, which is life-threatening. Do not climb into the appliance!



Caution!

Danger of cuts due to sharp edges. Always wear gloves when working in the chamber interior.

8.1.1 Working chamber and metal surfaces

Regular cleaning of the easy-to-clean working chamber prevents build up of material remains that could impair the appearance and functionality of the stainless steel working chamber over time.

The metal surfaces of the appliance can be cleaned with normal stainless steel cleaning agents. Make sure that no rusty objects come into contact with the working chamber or with the stainless steel housing. Rust deposits can lead to an infection of the stainless steel. If rust spots should appear on the surface of the working chamber due to impurities, the affected area must be immediately cleaned and polished.

8.1.2 Plastic parts

Do not clean the ControlCOCKPIT and other plastic parts of the appliance with caustic or solvent-based cleaning agents.

8.1.3 Glass surfaces

Glass surfaces can be cleaned with a commercially available glass cleaner.

8.2 Regular maintenance

Once a year, grease the moving parts of the doors (hinges and lock) with thin silicone grease and check that the hinge screws are not loose.

To guarantee perfect control, we recommend to calibrate the appliance once a year (see page 44).

8.3 Repairs and service



Warning!

After removing covers, live parts may be exposed. You may receive an electric shock if you touch these parts. Disconnect the mains plug before removing any covers. Any work inside the appliance may only be performed by qualified electricians.



Repairs and service work are described in a separate service manual.

9. Storage and disposal

9.1 Storage

The appliance may only be stored under the following conditions:

- ▶ in a dry and enclosed, dust-free room
- ▶ frost-free
- ▶ disconnected from the power supply

9.2 Disposal

This product is subject to the Directive 2012/19/EC on Waste Electrical and Electronic Equipment (WEEE) of the European Parliament and of the Council. This appliance has been brought to market after August 13th, 2005 in countries which have already integrated this directive into their national laws. It may not be disposed of in normal household waste. For disposal, please contact your dealer or the manufacturer. Any appliances that are infected, infectious or contaminated with materials hazardous to health are excluded from return. Please also observe all other regulations applicable in this context.

Before disposing of the appliance, please render the door locking mechanism unusable, for example, to prevent playing children from being locked inside the appliance.

There is a lithium battery in the ControlCOCKPIT of the appliance. Remove it and dispose of it in accordance with the regulations in your country (Fig. 25).

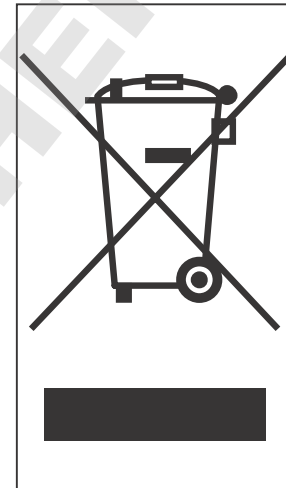

Fig. 25 Removing the lithium battery

Note for Germany:

The appliance may not be left at public or communal recycling or collection points.

Index

- A**
 Accessories 16
 Activation key 28
 Adjustment 44
 Air flap position 29
 Air supply 12
 Alarm 39
 Alarm temperature 40
 Ambient temperature 15
 Appliance error 34
 AtmoCONTROL 3, 13, 16
- B**
 Basic device settings 36
 Basic settings 36
- C**
 Calibration 44
 Carrying 17
 Cause of errors 34
 Chamber load 26
 Changes 8
 Cleaning 46
 Clock time 42
 Communication interfaces 13
 Compensation correction value 45
 Connections 13
 ControlCOCKPIT 27
 Convection 12
 Customer service 2
- D**
 Date and time 42
 Declaration of conformity 15
 Decommissioning 47
 Delivery 17, 18, 23
 Digital backwards counter 29
 Dimensions 15
 Disposal 47
 Door 25
- E**
 Electrical connection 13
 Electrical connections 23
 Electronic temperature monitoring 31
 Emergency 9
 Ending operation 32
- Error description 34
 Error messages 33
- F**
 factory calibration 45
 Fan speed 29
 Fehlermeldung 34
 Forklift truck 18
 Function 11
- G**
 Gas bottles 23
 Gateway 42
 Graph 32
 Grid 41
- H**
 Hazards 7
- I**
 Installation site 19
 Intended use 11
 Interfaces 13
 IP address 38
- L**
 Language selection 37
 Loading the appliance 26
 Log memory 35
- M**
 Maintenance 46
 Malfunctions 8, 33
 Manufacturer 2
 Material 12
 Mechanical temperature monitoring 32
 Medical device 11
 Menu 36, 42
 Minimum clearances 19
- N**
 Nameplate 13
 Network 13, 38
 Normal mode 28, 29
- O**
 Operating 25
 Operating modes 28
 Operating personnel 8, 25
 Operating problems 34
 Operation 25
- P**
 Packaging material 18
 Power failure 35
 Product safety 7
 Putting into operation 23
- R**
 Rectifying errors 34
 Regular maintenance 46
 Remote control 41
- S**
 Safety regulations 6
 Service 46
 Servicing 46
 Setting parameters 28, 37
 Setting up 17, 19
 Setup 38
 Shelf 41
 Slide-in unit 41
 Storage after delivery 18
 Switching off 32
 Switching on 24
- T**
 TB 32
 Technical data 14
 Temperature 29
 Temperature comparison 44
 Temperature deviation 44
 Temperature limiter 32
 Temperature monitoring 30, 39
 Time 41
 Timer 29
 Timer mode 41
 Transport 17, 18
 Transport damage 18
 Turn control 28
 TWB 30
 TWW 30
- U**
 Unit 39
 Unpacking 18
- W**
 Warning messages 13, 33
 Weight 14

DOMINIQUE DUTSCHER SAS

DOMINIQUE DUTSCHER SAS

DOMINIQUE DUTSCHER SAS

memmert

Universal ovens

Incubators

D33363 | Date 01/2020

englisch

Memmert GmbH + Co. KG
Postfach 1720 | D-91107 Schwabach
Tel. +49 9122 925-0 | Fax +49 9122 14585
E-Mail: sales@memmert.com
[facebook.com/memmert.family](https://www.facebook.com/memmert.family)