

Register your instrument!
www.eppendorf.com/myeppendorf



HeatSealer S100

Operating manual

Copyright© 2016 Eppendorf AG, Germany. All rights reserved, including graphics and images. No part of this publication may be reproduced without the prior permission of the copyright owner.

Eppendorf® and the Eppendorf logo are registered trademarks of Eppendorf AG, Germany.

Registered trademarks and protected trademarks are not marked in all cases with ® or ™ in this manual.

Table of contents

1	Operating instructions	5
1.1	Using this manual	5
1.2	Danger symbols and danger levels	5
1.2.1	Danger symbols	5
1.2.2	Danger levels	5
1.3	Symbols used	5
2	Safety	6
2.1	Intended use	6
2.2	Warnings for intended use	6
2.3	Warning signs on the device	7
2.4	User profile	7
2.5	Information on product liability	7
3	Product description	8
3.1	Delivery package	8
3.2	Features	8
3.3	Product overview	9
4	Installation	10
4.1	Preparing installation	10
4.2	Selecting the location	10
4.3	Changing the voltage	11
4.4	Connecting the device	12
5	Operation	13
5.1	Operating controls	13
5.1.1	Status LEDs	13
5.2	Sealing the plate	14
6	Troubleshooting	18
6.1	Thermal fuse triggered	18
6.2	The device cannot be switched on or does not heat up	18
7	Maintenance	19
7.1	Cleaning	19
7.2	Disinfection/Decontamination	20
7.3	Replacing fuses	21
8	Technical data	22

Table of contents

4 HeatSealer S100
English (EN)

9	Transport, storage and disposal	23
9.1	Decontamination before shipment	23
9.2	Transport	23
9.3	Storage	23
9.4	Disposal	24
10	Ordering information	25
	Certificates	27

DOMINIQUE DUTSCHER SAS

1 Operating instructions





1.1 Using this manual

- ▶ Read this operating manual completely before using the device for the first time. Also observe the instructions for use of the accessories.
- ▶ This operating manual is part of the product. Thus, it must always be easily accessible.
- ▶ Enclose this operating manual when transferring the device to third parties.
- ▶ You will find the current version of the operating manual for all available languages on our webpage under www.eppendorf.com.

1.2 Danger symbols and danger levels

The safety instructions of this operating manual indicate the following danger symbols and danger levels:

1.2.1 Danger symbols

	Hazard point		Hot surface
	Electric shock		Biohazard
	Material damage		

1.2.2 Danger levels

DANGER	<i>Will</i> lead to severe injuries or death.
WARNING	<i>May</i> lead to severe injuries or death.
CAUTION	May lead to light to moderate injuries.
NOTICE	May lead to material damage.

1.3 Symbols used

Depiction	Meaning
1.	Actions in the specified order
2.	
▶	Actions without a specified order
•	List
<i>Text</i>	Display text or software text
	Additional information

2 Safety**2.1 Intended use**

The Eppendorf HeatSealer S100 is used to seal plates using suitable films and foils.

The Eppendorf HeatSealer S100 can be used in training/routine/research labs in the life sciences, industry and chemistry sectors. The device may only be used for research purposes. Eppendorf does not provide a warranty for other applications. Not suitable for use in diagnostics or therapeutics.

2.2 Warnings for intended use**WARNING! Damage to health due to infectious liquids and pathogenic germs.**

- ▶ When handling infectious liquids and pathogenic germs, observe the national regulations, the biological security level of your laboratory, the material safety data sheets, and the manufacturer's application notes.
- ▶ Wear personal protective equipment.
- ▶ For comprehensive regulations about handling germs or biological material of risk group II or higher, please refer to the "Laboratory Biosafety Manual" (source: World Health Organization, Laboratory Biosafety Manual, in its respectively current valid version).

**CAUTION! Poor safety due to incorrect accessories and spare parts.**

The use of accessories and spare parts other than those recommended by Eppendorf may impair the safety, functioning and precision of the device. Eppendorf cannot be held liable or accept any liability for damage resulting from the use of incorrect or non-recommended accessories and spare parts, or from the improper use of such equipment.

- ▶ Only use accessories and original spare parts recommended by Eppendorf.

**NOTICE! Spilled liquid can cause damage to the device.**

- ▶ Switch off the device.
- ▶ Unplug the mains/power plug.
- ▶ Collect the spilled liquid. Observe the specifications for the liquid in the material safety data sheets.

2.3 Warning signs on the device

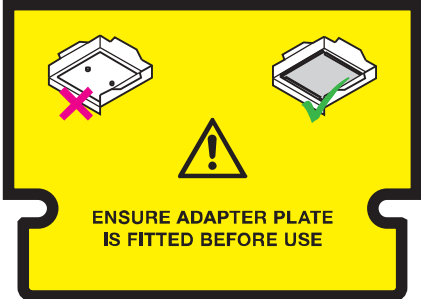
Warning sign	Meaning
	<p>CAUTION! Burns from hot surfaces. The metal surfaces of the heating plate reach temperatures of up to 170 °C.</p> <ul style="list-style-type: none"> ▶ Do not touch the hot surfaces. ▶ Let the device cool down to ambient temperature before starting an inspection or repair work.
	<p>Only use the device with the plate adapter inserted.</p>

2.4 User profile

This device may only be operated by trained and skilled personnel.

Before using the device, read the operating manual carefully and familiarize yourself with the device's mode of operation.

2.5 Information on product liability

In the following cases, the designated protection of the device may be compromised. Liability for any resulting property damage or personal injury is then transferred to the operator:

- The device is not used in accordance with the operating manual.
- The device is used outside of its intended use.
- The device is used with accessories or consumables which are not recommended by Eppendorf.
- The device is maintained or repaired by people not authorized by Eppendorf.
- The user makes unauthorized changes to the device.

3 **Product description**
3.1 **Delivery package**

Quantity	Description
1	HeatSealer S100
1	Mains/power cord
1	Adapter for 96-well PCR plates
1	Fuse for 115 V
1	Operating manual

3.2 **Features**

The heat sealer enables reliable and quick sealing of a multitude of plates.

Sealed plates protect samples against evaporation and are thus highly suitable for transporting or storing samples.

The HeatSealer S100 excels with the following features:

- Seals 96- and 384-well plates.
- Suitable for plates of different heights.
- Optimum sealing at preset temperature of plates using suitable films and foils.
- An integrated thermostat prevents the device from overheating.

3.3 Product overview

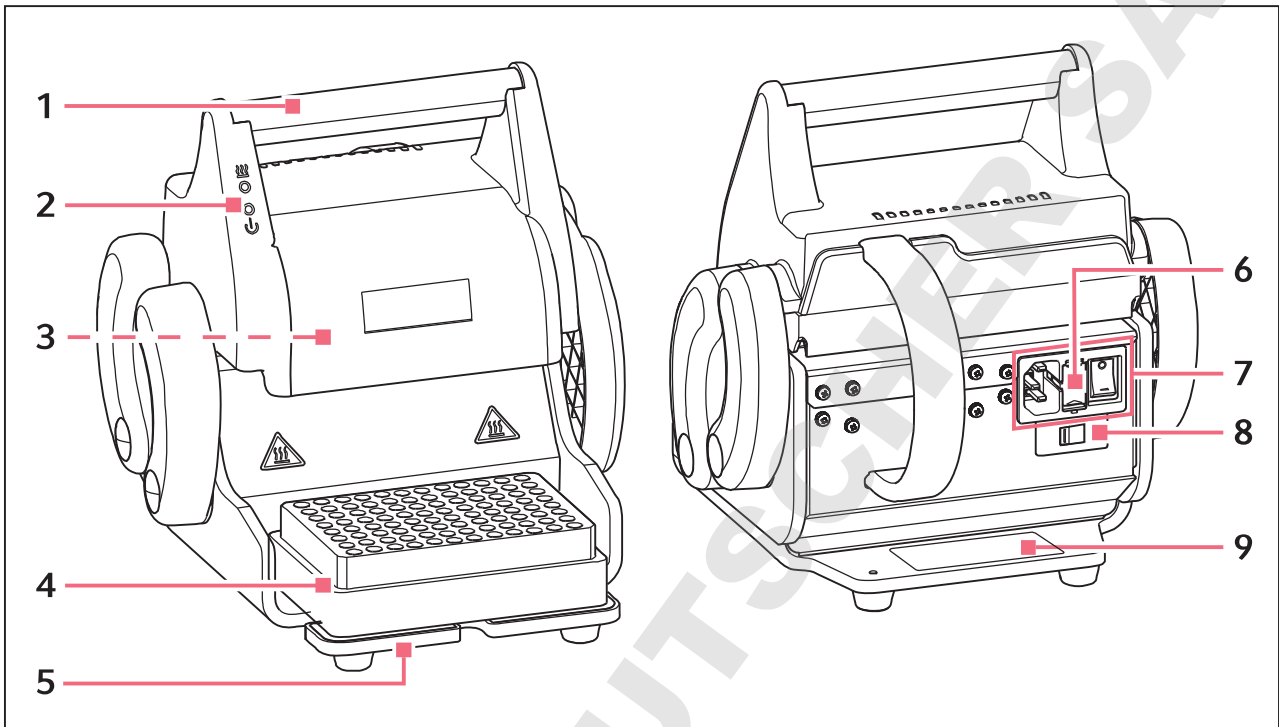

Fig. 3-1: HeatSealer S100

- | | | | |
|---|----------------|---|---|
| 1 | Handle | 6 | Fuse holder |
| 2 | Status LEDs | 7 | Mains/power cord socket with mains/
power switch |
| 3 | Heating plate | 8 | Selector switch for mains/power
supply voltage |
| 4 | Plate adapter | 9 | Name plate |
| 5 | Adapter holder | | |

4 **Installation**

4.1 **Preparing installation**

- ❗ Store the transport packaging and packing material for future safe transport or storage.
- ▶ Use the details included in the delivery package to check that the delivery is complete .
- ▶ Check all parts for any transport damage.

4.2 **Selecting the location**

Select the device location according to the following criteria:

- Mains/power connection in accordance with the name plate
 - Minimum distance to other devices and walls: 10 cm
 - Resonance free table with horizontal even work surface
 - The design of table is suitable for operating the device.
 - Surrounding area must be well ventilated.
 - The location must be protected against direct sunlight.
- ❗ The mains/power switch and cutting unit of the mains/power line must be easily accessible during operation (e.g, residual current circuit breaker).

4.3 Changing the voltage



DANGER! Electric shock.

- ▶ Switch off the device and disconnect the power plug before starting maintenance or cleaning work.



NOTICE! Damage to device due to a fuse that does not match the preselected mains/power supply voltage.

- ▶ Use a fuse that matches the preselected mains/power supply voltage in accordance with the table.

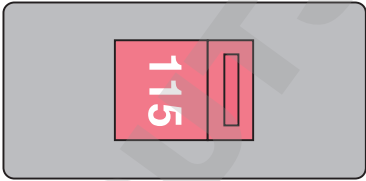
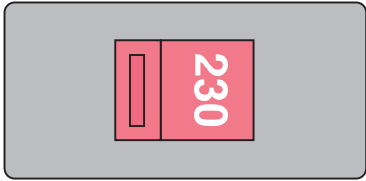

The device is supplied with a fuse for 230 V. If the device is to be converted for a mains/power supply voltage of 115 V, then the fuse must be replaced according to the table.

Setting the mains/power supply voltage on the device		
Voltage supply	110 - 120 V \pm 10 %	220 - 230 V \pm 10 %
Fuse	T3.15 AH 250 V 20x5 mm	T1.6 AH 250 V 20x5 mm

The selector switch for the mains/power supply voltage is located on the rear side of the device.



The mains/power cord socket with the mains/power switch is only sealed by a security sticker during delivery.

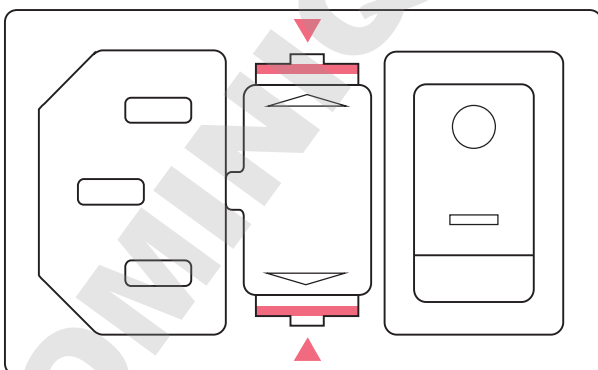

1. Remove the security sticker.
2. Set the mains/power supply voltage at the selector switch.
3. Compress the plastic springs at the top and bottom using two suitable screwdrivers and pull the fuse holder right out.
4. Insert a fuse for the selected mains/power supply voltage in the lower position of the fuse holder.
5. Reinsert the fuse holder. Make sure the guiding rail is in the correct position.

4.4 Connecting the device



WARNING! Risk from incorrect supply voltage

- ▶ Only connect the device to voltage sources which correspond to the electrical requirements on the name plate.
- ▶ Only use sockets with a protective earth (PE) conductor and suitable power cable.



WARNING! Electric shock due to damage to device or mains cable.

- ▶ Only switch on the device if the device and mains cable are undamaged.
- ▶ Only use devices that have been properly installed or repaired.
- ▶ In case of danger, disconnect the device from the mains supply by pulling the power plug from the device or the mains socket or, by using the isolating device intended for this purpose (e.g., emergency stop switch in the laboratory).



NOTICE! Damage to electronic components due to condensation.

Condensate can form in the device after it has been moved from a cool environment to a warmer environment.

- ▶ After installing the device, wait at least for 12 h. Only then connect the device to the mains.





Prerequisites

- Device is switched off.
- Electrical connection data in accordance with name plate.
- Voltage is switched on.
- Fuse matches selected voltage.
- ▶ Connect the mains/power cable included in the delivery.

5 Operation
5.1 Operating controls
5.1.1 Status LEDs

The heating plate automatically heats up to the sealing temperature when the device is switched on.

The device has two status LEDs that indicate the state of the device.

	<p>Status LED <i>heater</i></p> <ul style="list-style-type: none"> • Illuminates orange Heating plate heats up. • flashes briefly orange, goes out for approx. 2 minutes, and then flashes continuously Sealing temperature of 170 °C ±2 °C has been reached.
	
	<p>Status LED <i>power</i></p> <ul style="list-style-type: none"> • Lights up green Device switched on. • Not illuminated Device switched off.
	

5.2 Sealing the plate



CAUTION! Crush hazard due to moving assemblies.

Risk of crushing your fingers or hands in case of improper operation.

- ▶ Do not place your fingers between the moving device components when sealing the plate.
- ▶ Do not keep hold of the foil during the sealing process.



CAUTION! Burns from hot surfaces.

The metal surfaces of the heating plate can reach temperatures of up to 170 °C.

- ▶ Do not touch the hot surfaces.
- ▶ Before commencing tests or repairs, let the device cool down to room temperature.



NOTICE! Damage to device due to unsuitable consumables.

The metal surfaces of the heating plate reach temperatures of up to 170 °C. Consumables with a low temperature resistance can burn or melt.

- ▶ Only use consumables with a temperature resistance suitable for the sealing temperature.
- ▶ Do not exceed the optimum sealing duration.



The sealing duration depends on the selected combination of plate and foil. A sealing duration that is too long can damage the plate, destroy samples and reduce the sealing quality. Before sealing plates with samples, determine the optimum sealing time with an empty plate. Start with 2 s to 3 s.

i The optimum height for sealing is set by means of the adapter.

▶ Make sure that adapter and plate match.

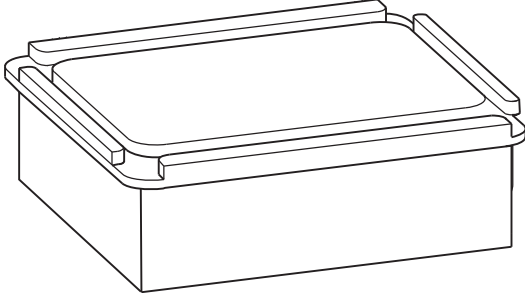
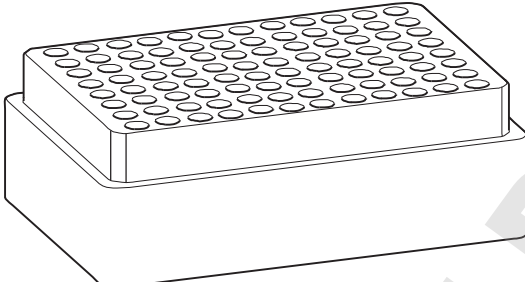
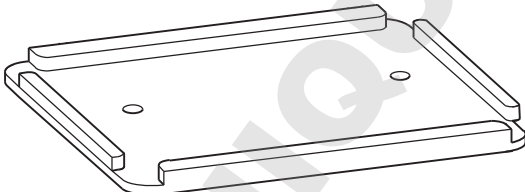
Adapter	Matching plates
<p>Plate Adapter, high profile (not included in the HeatSealer delivery package)</p> 	<p>96-well Microplates 384-well Microplates 384-well PCR Plates Deepwell Plate 384/200μL Deepwell Plate 96/500μL</p>
<p>96-well PCR Plate Adapter</p> 	<p>96-well PCR Plates unskirted 96-well PCR Plates semi-skirted 96-well PCR Plates skirted</p>
<p>Plate Adapter, low profile (not included in the HeatSealer delivery package)</p> 	<p>Deepwell Plate 96/1000μL Deepwell Plate 96/2000μL</p>

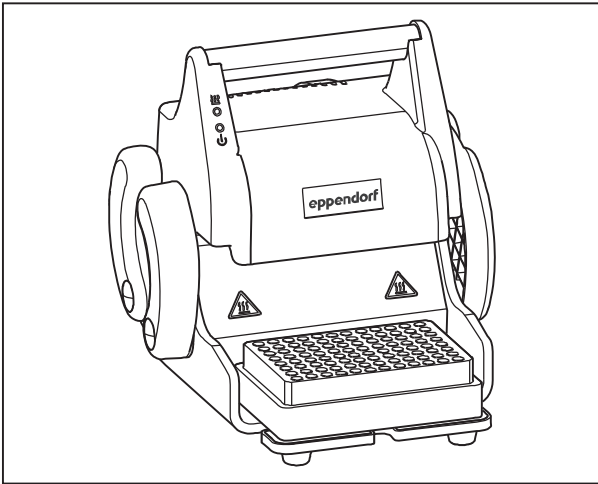

1. Switch on the device.
The status LED *heater* illuminates whilst the heating plate heats up. The device is ready for operation when the status LED flashes continuously.
2. Insert adapter.

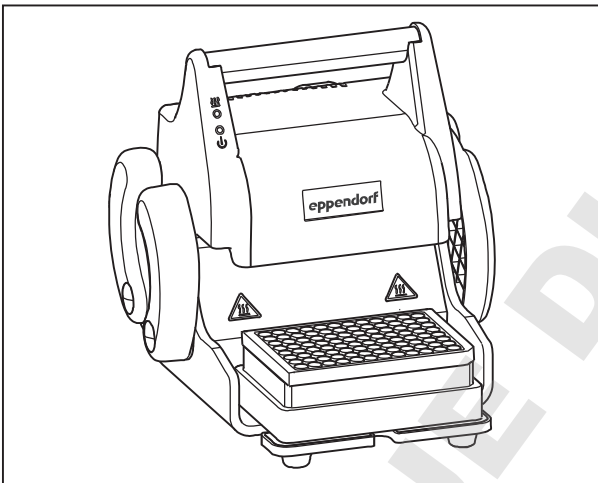

3. Put the plate on the adapter.

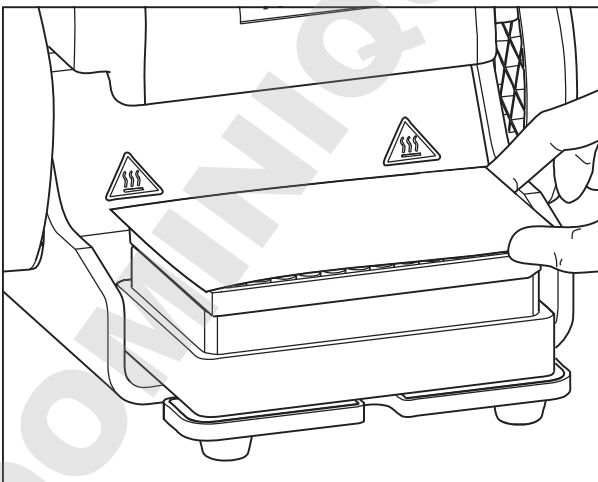

4. Position the foil on the plate. The foil must be laid with the sealing or adhesive side down on the plate.

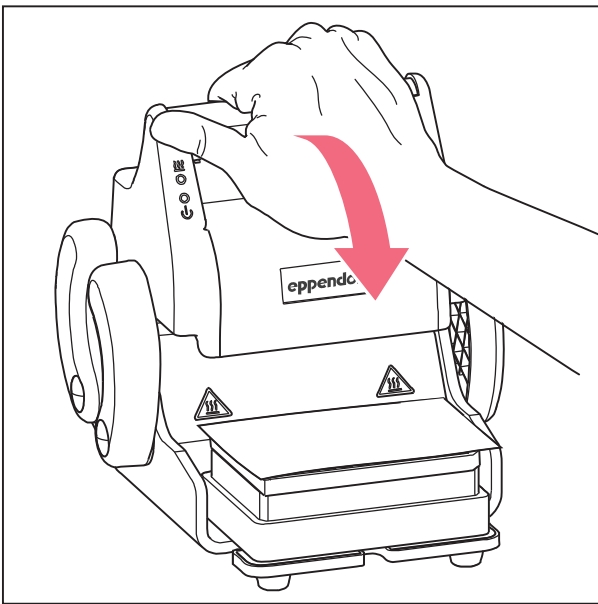

5. Press the handle down until the heating plate makes contact with the foil.

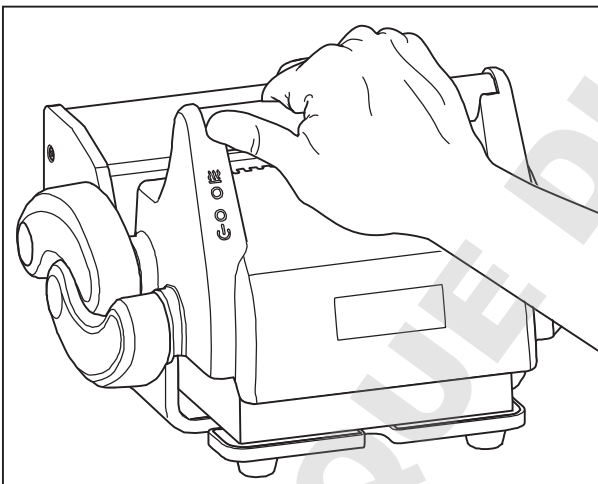

6. Press with sufficient force during the sealing time to ensure proper contact between the heating plate and the foil.

7. Shift the handle back to its starting position.

8. Let the sealed plate cool off.

9. Remove the plate.

10. If no other plates are to be sealed: switch the device off.

6 Troubleshooting

6.1 Thermal fuse triggered

The device is equipped with a thermal fuse. When a temperature of 195 °C is exceeded on the heating plate, the thermal fuse triggers and switches the heating plate off permanently.

When this happens, the status LED for the heating plate continues to burn even though the heating plate can no longer heat up and stays cold.

- ▶ Send the defective device to the authorized service center.

6.2 The device cannot be switched on or does not heat up

1. Check the mains/power plug and mains/power cord.
2. Check the set mains/power supply voltage and the fuse. Replace the fuse if it is defective.
3. Switch the device off and back on.

 If none of these measures could eliminate the problem:

- ▶ Send the defective device to the authorized service center.

7 Maintenance

7.1 Cleaning

Regularly clean the housing of the device and the adapter.



DANGER! Electric shock as a result of penetration of liquid.

- ▶ Switch off the device and disconnect the power plug before starting cleaning or disinfection work.
- ▶ Do not allow any liquids to penetrate the inside of the housing.
- ▶ Do not spray clean/spray disinfect the housing.
- ▶ Only plug the device back in if it is completely dry, both inside and outside.



NOTICE! Damage from the use of aggressive chemicals.

- ▶ Do not use any aggressive chemicals on the device or its accessories, such as strong and weak bases, strong acids, acetone, formaldehyde, halogenated hydrocarbons or phenol.
- ▶ If the device has been contaminated by aggressive chemicals, immediately clean it by means of a mild cleaning agent.



NOTICE! Corrosion from aggressive cleaning agents and disinfectants.

- ▶ Do not use corrosive cleaning agents, aggressive solvents or abrasive polishes.



NOTICE! Improper tools can cause damage.

Removing residuals on the heating plate with tools can destroy the heating plate.

- ▶ Only use a lint-free cloth to clean the device and the heating plate.

Aids

- Lint-free cloth.
- Mild soap-based laboratory cleaner.
- Distilled water.

Cleaning the device

1. Switch off the device and disconnect it from the mains/power line.
2. Allow device to cool down.
3. Clean all exterior parts of the device and the adapter plate with a mild soap solution and lint-free cloth.
4. Wipe off the soap solution with distilled water.
5. Dry all cleaned parts.

7.2 Disinfection/Decontamination



DANGER! Electric shock as a result of penetration of liquid.

- ▶ Switch off the device and disconnect the power plug before starting cleaning or disinfection work.
 - ▶ Do not allow any liquids to penetrate the inside of the housing.
 - ▶ Do not spray clean/spray disinfect the housing.
 - ▶ Only plug the device back in if it is completely dry, both inside and outside.
-

1. Switch off the device and disconnect it from the mains/power line.
2. Remove all cables and accessory parts from the device.
3. Clean the device with a mild cleaning agent before the disinfection.
4. Select a disinfection method that corresponds with the legal provisions and guidelines valid for your area of application.

i Use e.g. alcohol (ethanol, isopropanol) or alcoholic disinfectant.

5. Wipe the surfaces with a lint-free cloth that has been moistened with disinfectant.
6. Disinfect all parts that are to be sent in with the device.

7.3 Replacing fuses



DANGER! Electric shock.

- ▶ Switch off the device and disconnect the power plug before starting maintenance or cleaning work.



NOTICE! Damage to device due to a fuse that does not match the preselected mains/power supply voltage.

- ▶ Use a fuse that matches the preselected mains/power supply voltage in accordance with the table.

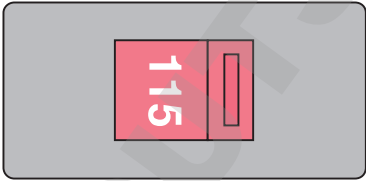
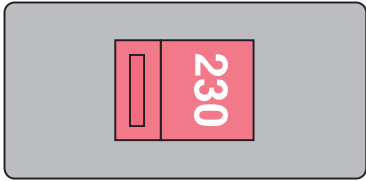

The device is supplied with a fuse for 230 V. If the device is to be converted for a mains/power supply voltage of 115 V, then the fuse must be replaced according to the table.

Setting the mains/power supply voltage on the device		
Power supply	110 - 120 V \pm 10 %	220 - 230 V \pm 10 %
Safety	T3.15 AH 250 V 20x5 mm	T1.6 AH 250 V 20x5 mm

The fuse holder is located between the mains/power cord socket and the mains/power switch.

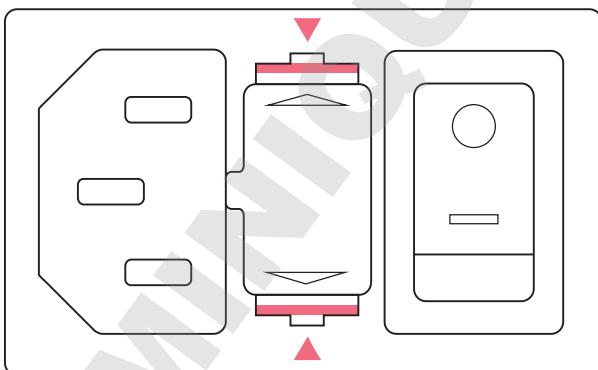

1. Switch off the device and disconnect the mains/power plug.
2. Compress the plastic springs at the top and bottom using a suitable screwdriver and pull the fuse holder right out.
3. Replace the defective fuse.
4. Reinsert the fuse holder. Make sure the guiding rail is in the correct position.

8 Technical data

Weights and dimensions

Weight	4 kg
Dimensions	Width: 220 mm Depth: 250 mm Height: 230 mm

Mains/power supply

Voltage supply	
	115: 110 - 120 V ± 10 % / 50 Hz to 60 Hz ± 5 %
	230: 220 - 230 V ± 10 % / 50 Hz to 60 Hz ± 5 %
Power consumption, max.	350 W
Degree of pollution	2 (IEC 664)
Protection class	I
Overtoltage category	II
Fuses	
	115: T3.15 AH 250 V 20x5 mm
	230: T1.6 AH 250 V 20x5 mm

Ambient conditions

For indoor use only	
Ambient temperature	+18 °C to +35 °C
Relative humidity	20 % to 80 %
Atmospheric pressure	Use up to a height of 2200 m above sea level

Operating parameters

Operating temperature (not adjustable)	170 °C
Tolerance range	± 2 °C

9 Transport, storage and disposal

9.1 Decontamination before shipment

If you are shipping the device to the authorized Technical Service for repairs or to your authorized dealer for disposal please note the following:



WARNING! Risk to health from contaminated device

1. Follow the instructions in the decontamination certificate. You find it as a PDF file on our website (www.eppendorf.com/decontamination).
2. Decontaminate all the parts you would like to dispatch.
3. Include the fully completed decontamination certificate in the package.

9.2 Transport

- ▶ Use the original packing for transport.
- ▶ Use the transport securing devices.

	Air temperature	Relative humidity	Atmospheric pressure
General transport	-10 °C – +50 °C	20 % – 95 %	300 hPa – 1060 hPa
Air freight	-10 °C – +50 °C	20 % – 95 %	300 hPa – 1060 hPa

9.3 Storage

	Air temperature	Relative humidity	Atmospheric pressure
In transport packing	-10 °C – +50 °C	20 % – 95 %	700 hPa – 1060 hPa
Without transport packing	-10 °C – +50 °C	20 % – 95 %	700 hPa – 1060 hPa

9.4 Disposal

In case the product is to be disposed of, the relevant legal regulations are to be observed.

Information on the disposal of electrical and electronic devices in the European Community:

Within the European Community, the disposal of electrical devices is regulated by national regulations based on EU Directive 2012/19/EU pertaining to waste electrical and electronic equipment (WEEE).

According to these regulations, any devices supplied after August 13, 2005, in the business-to-business sphere, to which this product is assigned, may no longer be disposed of in municipal or domestic waste. To document this, they have been marked with the following identification:



Because disposal regulations may differ from one country to another within the EU, please contact your supplier if necessary.

10 Ordering information

Order no. (International)	Order no. (North America)	Description
5391 000.001 5392 000.005	5391000001 5392000005	HeatSealer 110 V – 230 V/50 Hz– 60 Hz S100 S200
5391 070.018	5391070018	Plate Adapter, low profile, for HeatSealer S100
5391 070.026	5391070026	96-well PCR Plate Adapter, for HeatSealer S100
5391 070.034	5391070034	Plate Adapter, high profile, for HeatSealer S100
0030 127.838	0030127838	Heat Sealing Film 100 pieces
0030 127.854	0030127854	Heat Sealing Foil 100 pieces

DOMINIQUE DUTSCHER SAS

Declaration of Conformity

The product named below fulfills the requirements of directives and standards listed. In the case of unauthorized modifications to the product or an unintended use this declaration becomes invalid.

Product name:

HeatSealer S100

Product type:

Heatsealer

Relevant directives / standards:

2014/35/EU: IEC 61010-1, EN 61010-2-010

2014/30/EU: EN 61326-1

2011/65/EU: EN 50581

UL 61010-1, CAN/CSA C22.2 No. 61010-1

FCC CFR 47 Parts 15.107 and 15.109, Class B

Date: April 18, 2016



Management Board



Portfolio Management

Your local distributor: www.eppendorf.com/contact
Eppendorf AG · 22331 Hamburg · Germany
eppendorf@eppendorf.com

Eppendorf® and the Eppendorf logo are registered trademarks of Eppendorf AG, Germany.
U.S. Design Patents are listed on www.eppendorf.com/ip.
All rights reserved, incl. graphics and pictures. Copyright 2015 © by Eppendorf AG.

www.eppendorf.com

ISO 9001
Certified

ISO
13485
Certified

ISO
14001
Certified

DOMINIQUE DUTSCHER SAS

DOMINIQUE DUTSCHER SAS

Evaluate Your Manual

Give us your feedback.
www.eppendorf.com/manualfeedback

Your local distributor: www.eppendorf.com/contact

Eppendorf AG · 22331 Hamburg · Germany
eppendorf@eppendorf.com · www.eppendorf.com