

Register your instrument!  
[www.eppendorf.com/myeppendorf](http://www.eppendorf.com/myeppendorf)



Centrifuge  
Centrifuge 5427 R

Original Operating Instructions



Copyright © 2023 Eppendorf SE, Germany. All rights reserved, including graphics and images. No part of this publication may be reproduced without the prior permission of the copyright owner.

Eppendorf® and the Eppendorf Brand Design are registered trademarks of Eppendorf SE, Germany.

Eppendorf trademarks and trademarks of third parties may appear in this manual. All trademarks are the property of their respective owners. The respective trademark name, representations and listed owners can be found on [www.eppendorf.com/ip](http://www.eppendorf.com/ip).

The software of this product contains open source software. License information is available in the delivery box.

U.S. Patents and U.S. Design Patents are listed on [www.eppendorf.com/ip](http://www.eppendorf.com/ip).

DOMINIQUE DUTSCHER SAS

## Table of contents

<b>1</b>	<b>About this manual</b> .....	<b>6</b>
1.1	About this manual.....	6
1.2	Warning notice structure.....	6
1.3	Graphics.....	6
1.4	Other applicable documents.....	7
<b>2</b>	<b>Safety</b> .....	<b>8</b>
2.1	Intended use.....	8
2.2	Residual risks when used as intended.....	8
2.2.1	Personal injury.....	8
2.2.2	Material damage.....	9
2.3	Application limits.....	11
2.4	Target groups.....	11
2.5	Information for the owner.....	11
2.6	Personal protective equipment.....	12
2.7	Information on product liability.....	12
2.8	Information on the device and rotors.....	12
<b>3</b>	<b>Product description</b> .....	<b>14</b>
3.1	Features.....	14
3.2	Product overview.....	15
3.3	Product components.....	15
3.4	Control panel.....	16
3.4.1	Overview of the.....	16
3.4.2	Operating controls.....	16
3.4.3	Display.....	17
3.4.4	Symbols.....	17
3.5	Name plate.....	19
3.6	Rotors.....	20
3.6.1	Fixed-angle rotor.....	20
3.6.2	Swing-bucket rotor.....	21
<b>4</b>	<b>Functional description</b> .....	<b>22</b>
4.1	Centrifugation runs.....	22
4.2	Cooling.....	22
4.3	VisioNize Lab Suite.....	22
4.4	FastTemp function.....	22
4.5	Overview of basic functions.....	22
<b>5</b>	<b>Installation</b> .....	<b>24</b>
5.1	Preparing installation.....	24
5.1.1	Checking the delivery.....	24
5.1.2	Checking the electrical connection.....	24
5.1.3	Checking the location.....	25
5.1.4	Unpacking the device.....	25
5.2	Performing the installation.....	25
5.2.1	Positioning the device.....	25

5.2.2	Connecting the device to the voltage supply.....	26
5.2.3	Removing the transport securing devices.....	26
<b>6</b>	<b>Operation.....</b>	<b>27</b>
6.1	Preparing the device for the application.....	27
6.1.1	Selecting the rotor and accessories.....	27
6.1.2	Switching on the device.....	27
6.1.3	Opening the centrifuge lid.....	27
6.1.4	Closing the centrifuge lid.....	28
6.1.5	Replacing the rotor.....	28
6.1.6	Triggering rotor detection.....	28
6.1.7	Opening the rotor lid.....	29
6.1.8	Closing the rotor lid.....	30
6.1.9	Tempering the rotor chamber with FastTemp.....	30
6.1.10	Adapting the rotor radius.....	31
6.1.11	Preparing tubes.....	31
6.1.12	Loading the rotor.....	32
6.2	Performing a centrifugation.....	34
6.2.1	Performing a centrifugation with time setting.....	34
6.2.2	Performing a centrifugation without time setting.....	35
6.2.3	Performing a centrifugation with ShortSpin.....	36
6.2.4	Switching off the device.....	38
6.3	Advanced settings.....	38
6.3.1	Activating and deactivating the key lock.....	38
6.3.2	Activating and deactivating the signal tone.....	38
6.3.3	Setting the volume of the signal tone.....	39
6.3.4	Activating/deactivating the standby mode.....	39
6.3.5	Setting the cooling time after centrifugation.....	40
6.3.6	Activating time measurement.....	40
6.3.7	Setting the ShortSpin centrifugation speed.....	41
6.3.8	Setting the acceleration time and deceleration time.....	41
<b>7</b>	<b>Maintenance.....</b>	<b>42</b>
7.1	Maintenance plan.....	42
7.2	Service.....	42
7.2.1	Checking the device.....	43
7.2.2	Checking the rotor and accessories.....	43
7.2.3	Removing the sealing ring from the rotor lid.....	43
7.2.4	Inserting the sealing ring into the rotor lid.....	44
7.2.5	Documenting the service life.....	44
7.3	Cleaning.....	44
7.3.1	Cleaning a contaminated device.....	44
7.3.2	Cleaning the device and rotor after glass breakage.....	45
7.3.3	Cleaning the condensation water tray.....	46
7.3.4	Cleaning the fixed-angle rotor.....	46
7.3.5	Cleaning the swing-bucket rotor.....	47
7.3.6	Cleaning the accessories.....	48
7.3.7	Autoclaving the rotor and accessories.....	49
7.4	Care instructions.....	49

<b>8</b>	<b>Troubleshooting</b> .....	<b>50</b>
8.1	General errors .....	50
8.2	Error message of the software .....	51
8.3	Emergency release of the centrifuge lid .....	54
<b>9</b>	<b>Shut down</b> .....	<b>56</b>
9.1	Disconnecting the device from the voltage supply .....	56
<b>10</b>	<b>Transport</b> .....	<b>57</b>
10.1	Preparing the device for transport .....	57
10.2	Transporting the device .....	57
10.3	Shipping the device .....	57
<b>11</b>	<b>Storage</b> .....	<b>59</b>
11.1	Storing accessories .....	59
<b>12</b>	<b>Disposal</b> .....	<b>60</b>
12.1	Legal requirements .....	60
12.2	Disposal in the target market .....	60
12.3	Preparing for disposal .....	60
12.4	Handing over the device to the disposal company .....	61
<b>13</b>	<b>Technical data</b> .....	<b>62</b>
13.1	Dimensions .....	62
13.2	Weight .....	62
13.3	Mains/power supply .....	62
13.4	Refrigeration system .....	63
13.5	Ambient conditions .....	63
13.6	Interfaces .....	64
13.7	Noise level .....	64
13.8	Acceleration and deceleration times .....	64
13.9	Application parameters .....	66
13.10	Service life of rotors, rotor lids and accessories .....	67
<b>14</b>	<b>Suitable rotors</b> .....	<b>68</b>
14.1	Rotor FA-45-12-17 .....	68
14.2	Rotor FA-45-24-11 .....	68
14.3	Rotor FA-45-24-11-Kit .....	69
14.4	Rotor FA-45-30-11 and F-45-30-11 .....	70
14.5	Rotor FA-45-48-11 and rotor F-45-48-11 .....	71
14.6	Rotor F-45-48-5-PCR .....	73
14.7	Rotor S-24-11-AT .....	73
<b>15</b>	<b>Ordering information</b> .....	<b>75</b>
15.1	Rotors .....	75
15.2	Accessories .....	78
<b>16</b>	<b>Appendix</b> .....	<b>79</b>

## 1 About this manual

### 1.1 About this manual

1. Please read this manual before you use the product.
2. Please ensure that you have the manual available during the use of the product.

-  You can find the current version of the manual at [www.eppendorf.com/manuals](http://www.eppendorf.com/manuals).
- Please contact Eppendorf SE to obtain a different version of the manual.

### 1.2 Warning notice structure





#### HAZARD LEVEL! Type of danger

Source of danger  
Consequences of disregarding the danger

- Measures to avoid the danger

Symbol	Hazard level	Type of danger	Meaning
	<b>DANGER</b>	Personal injury	Will lead to severe injuries or death.
	<b>WARNING</b>	Personal injury	May lead to severe injury or death.
	<b>CAUTION</b>	Personal injury	May lead to minor or moderate injuries.
	<b>NOTE</b>	Material damage	May lead to material damage.

### 1.3 Graphics

Depiction	Meaning
1.	Work steps
2.	
•	Bullet point
<i>Text</i>	Display text
<b>Key</b>	Name for port, button, status display or key
	Important information
	Tip

## 1.4 Other applicable documents

The following documents supplement this manual:

- Instructions for use of the rotors
- Instructions for use for aerosol-tight centrifugation
- VisioNize box operating manual

DOMINIQUE DUTSCHER SAS

## 2 Safety

### 2.1 Intended use

The centrifuge is used for separating aqueous solutions and suspensions of different densities in approved sample tubes.

The centrifuge is intended for indoor use only. All country-specific safety requirements for operating electrical equipment in laboratories must be observed.

### 2.2 Residual risks when used as intended

If the product is not used as intended, the installed safety devices may not function correctly. To reduce the risk of personal injury and material damage and to avoid dangerous situations, please observe the general safety instructions.

#### 2.2.1 Personal injury

##### 2.2.1.1 Biological hazards

Infectious liquids and pathogenic germs can damage your health.

- Observe the national regulations and the biosafety level of your laboratory.
- Wear personal protective equipment.
- Observe the Safety Data Sheets and instructions for use for the accessories.
- Consult the "Laboratory Biosafety Manual" (source: World Health Organization, Laboratory Biosafety Manual, as amended) for comprehensive regulations on handling of germs or biological material of risk group II or higher.

If unsuitable or damaged rotors, rotor lids or accessories are used in aerosol-tight centrifugation, hazardous aerosols may escape.

- Only use aerosol-tight rotors and rotor lids and aerosol-tight accessories.
- Check all rotors, rotor lids and accessories for perfect condition before each use.

##### 2.2.1.2 Explosion hazards

The use of explosive substances or substances with violent reactions may cause explosions to occur. Do not operate the device under the following conditions:

- In an explosive atmosphere
- In areas where work with explosive substances is carried out
- With explosive substances or substances with violent reactions
- With substances that may create an explosive atmosphere when reacting with other substances

The R290 refrigerant used in the device is flammable. If the refrigeration cycle is defective, the refrigerant may escape and form explosive mixtures with the ambient air.

- Observe the regulations that apply to your laboratory.
- Make sure there is a sufficient volume of air at the location.
- Ensure adequate ventilation of the device at the location.

### 2.2.1.3 Electrical hazards

Touching parts that are under high voltage may result in an electric shock. A fatal electric shock causes cardiac arrhythmia and respiratory paralysis.

- Only use earth/grounded sockets with a protective earth (PE) conductor.
- Ensure that the housing and the mains/power cord are undamaged.
- Do not open or remove the housing.
- Compare the technical data of the mains/power cord with the technical data on the name plate, taking into account national laws and regulations. This also includes certification marks if required by law. Only use permissible mains/power cords with plugs.
- Only clean and perform maintenance on the device when it is disconnected from the mains/power line.
- Have an authorized service technician check the electrical safety of the device every 12 months.

If liquids get inside the device, users may suffer an electric shock. A fatal electric shock causes cardiac arrhythmia and respiratory paralysis.

- Switch off the device and disconnect it from the mains/power line before starting cleaning or disinfection.
- Do not connect the device to the mains/power line unless both the inside and outside of the device are completely dry.

### 2.2.1.4 Risks of burns

Assemblies of the device may overheat if the current consumption is too high. Persons may burn themselves on the floor assemblies.

- Do not touch hot assemblies.
- Only connect the device to an electric circuit that has its own protection.
- Do not connect any other devices to the electric circuit.

## 2.2.2 Material damage

### 2.2.2.1 Chemical hazards

Aggressive chemicals and aggressive cleaning agents and disinfectants may damage the material of the device, rotor and accessories. This may lead to damage in the interior of the device during operation.

- Protect all assemblies against aggressive chemicals.
- Clean and disinfect all assemblies only with the recommended cleaning agents and disinfectants.
- Inspect all assemblies for changes in the materials before each use.
- If a device is damaged, take it out of operation.
- If a rotor is damaged, replace it.
- Replace damaged accessories.

### 2.2.2.2 Electrical hazards

Connecting the device to an incorrect voltage supply will damage the device.

- Only connect the device to voltage sources that correspond to the requirements on the name plate.
- Only use earth/grounded sockets with a protective earth (PE) conductor.
- Compare the technical data of the mains/power cord with the technical data on the name plate, taking into account national laws and regulations. This also includes certification marks if required by law.

Condensate may form in the device due to transport of the device from a cool environment to a warmer environment and cause a short-circuit.

- Wait for at least 4 h after setting up the device. Connect the device to the mains/power line after this.

Liquid may escape the rotor chamber and reach the electronics, causing a short-circuit.

- Only use undamaged sample tubes.
- Do not use any deformed or brittle sample tubes.
- Only place closed sample tubes in the rotor.
- Wipe up spilled liquid immediately.

### 2.2.2.3 Incorrect handling

The use of accessories and spare parts other than those recommended by Eppendorf SE may impair the safety, functioning, and precision of the device. Eppendorf SE cannot be held liable or accept any liability for damage resulting from the use of accessories and spare parts other than those recommended.

- Use only the accessories and spare parts recommended by Eppendorf SE.

Incorrect handling of tubes may cause sample loss.

- Observe the manufacturer's instructions for tubes.
- Use tubes with the following properties:
  - Chemically resistant to the sample
  - Sufficient resilience in accordance with the maximum  $g$ -force
  - Valid service life
  - Undamaged, not deformed and not brittle
- Autoclave tubes in accordance with the manufacturer's instructions.

Incorrect handling of rotors may damage the device, rotors and tubes.

- Only use recommended accessories and recommended tubes.
- Load the rotor symmetrically.
- Only load the rotor to its maximum load capacity.
- Insert the rotor properly. Tighten the rotor nut.
- Do not move the device during operation.
- Stop centrifugation immediately if unusual noises are heard.

High-energy radiation may lead to damage of the device.

- Do not use UV, beta or gamma rays, or any other high-energy forms of radiation for disinfection.
- Avoid storage in areas with strong UV radiation.

#### 2.2.2.4 Mechanical hazards

The compressor and refrigeration system may become damaged if the device is switched on while tilted or if the device is switched on immediately after it has been tilted.

- Leave the device in the normal position for at least four hours before switching it on.
- Do not place the device upside down.

### 2.3 Application limits

Due to its design, the device is not suitable for use in a potentially explosive atmosphere.

The device may only be used in a safe environment, such as a ventilated laboratory or under a fume hood. Substances which may potentially contribute to an explosive atmosphere may not be used.

### 2.4 Target groups

This manual addresses the following target groups who have different qualifications and levels of knowledge.

#### Owner

The owner is any natural or legal person who operates or owns the device.

The owner provides the device and the necessary infrastructure. The owner has a special responsibility to ensure the safety of all persons working on the device.

#### User

The user operates the device and works with it. The user must be instructed in the use of the device. The user must have read and fully understood the manual.

Any tasks that go beyond operation may only be performed by the user if this is specified in this manual. The owner must explicitly assign these tasks to the user.

#### Technical personnel

The technical personnel monitors the building services and ensures the technical prerequisites for the operation of the device.

#### Authorized service technician

The authorized service technician has been trained and certified by Eppendorf SE to service, maintain, and repair the device.

### 2.5 Information for the owner

The owner must ensure the following:

- The device is in a safe operating condition.
- The safety devices are all available and functioning.
- The device is serviced and cleaned in accordance with the instructions in this manual.
- The device is disposed of in accordance with local regulations.

- All work on the device is carried out by users, technical personnel or authorized service technicians who are suitably qualified.
- Personal protective equipment is available and is worn.
- The manual is available during the use of the product.
- The manual is part of the product. The product will only be passed on to others with its manual.

## 2.6 Personal protective equipment

The personal protective equipment ensures the safety and protection of the users working on the device.

Personal protective equipment must comply with country-specific regulations and the regulations of the laboratory.

### Laboratory protective clothing

The clothing protects against contamination and infection.

### Safety boots

The boots protect the wearer against injury from heavy loads and improve grip on slippery floors.



## 2.7 Information on product liability







Liability for any resulting personal injury or material damage is transferred to the owner in the following cases:

- The device is used outside of its intended use
- The device is not used in accordance with the operating manual
- The device has spare parts installed that are not authorized by Eppendorf SE
- The device is used with accessories or consumables that are not recommended by Eppendorf SE
- Cleaning agents are used that are not recommended by Eppendorf SE
- Chemicals are used that are not recommended by Eppendorf SE
- Not shipped in original packing or in improper replacement packing
- The device is maintained or repaired by persons not authorized by Eppendorf SE
- Unauthorized changes have been made to the device

## 2.8 Information on the device and rotors

### Information on the device

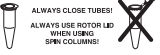
Information	Meaning	Location
	WARNING Observe the safety-relevant information in the operating manual.	Right side of the device
	Read the operating manual.	Right side of the device

Information	Meaning	Location
	WARNING The device contains the flammable R290 refrigerant.	Rear of the device
	WARNING Risk of cryogenic burns	Upper side of the device, under the centrifuge lid
	WARNING Risk of hand injuries	Upper side of the device, under the centrifuge lid
	Risk of damage to health when handling infectious liquids or pathogenic germs.	Upper side of the device, under the centrifuge lid
	Always seal the tubes. If you are inserting centrifuge tubes, use the rotor lid to seal the rotor.	Upper side of the device, under the centrifuge lid
	Tighten the rotor nut using the rotor key provided.	Upper side of the device, under the centrifuge lid
	Fire hazard or explosion hazard. Dispose of the device in accordance with the applicable laws and regulations. The device contains a flammable refrigerant. Use the device in accordance with the intended use.	120 V devices: right side of the device

**Information on rotors**

Information	Meaning	Location
	WARNING Risk of damage to health when handling infectious liquids or pathogenic germs.	Rotor lids of aerosol-tight fixed-angle rotors

### **3 Product description**

#### **3.1 Features**

The device has the following specific properties:

- Cooling function
- Optional connection of the device to a VisioNize Lab Suite via a VisioNize box
- Various rotors can be used

The following consumables can be used with the device:

- Micro test tubes with volumes of 0.2 mL – 5.0 mL
- PCR strips
- Microtainer tubes with a volume of 0.6 mL
- Centrifugation columns with volumes of 1.5 mL and 2.0 mL

DOMINIQUE DUTSCHER SAS

### 3.2 Product overview

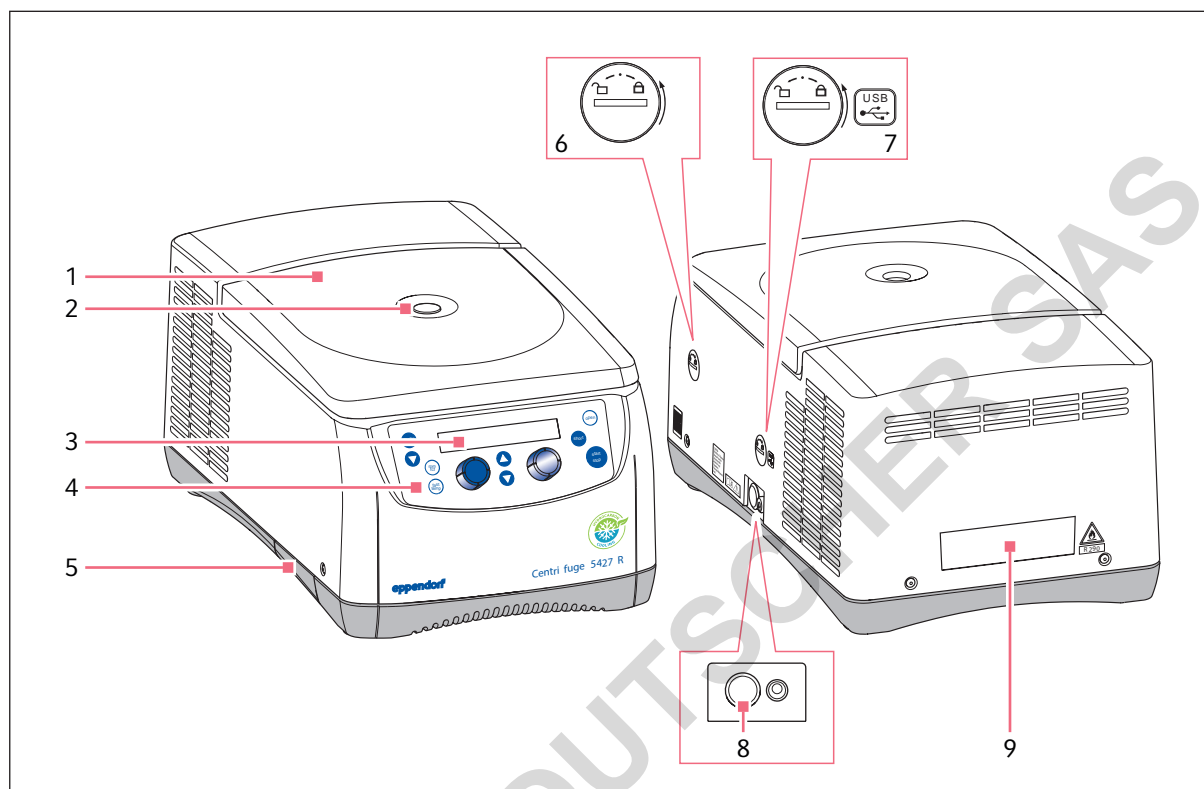

Fig. 3-1: Front and rear of the device

- |   |                         |   |                                   |
|---|-------------------------|---|-----------------------------------|
| 1 | Centrifuge lid          | 6 | Emergency release                 |
| 2 | Monitoring glass        | 7 | USB interface for software update |
| 3 | Display                 | 8 | On/off switch                     |
| 4 | Control panel           | 9 | Name plate                        |
| 5 | Condensation water tray |   |                                   |

### 3.3 Product components

#### Emergency release

Use the emergency release to open the centrifuge lid if it cannot be opened via the **open** key.

#### Monitoring glass

The monitoring glass is used for visual inspection for rotor stop and allows a speed check with a stroboscope.

## 3.4 Control panel

### 3.4.1 Overview of the

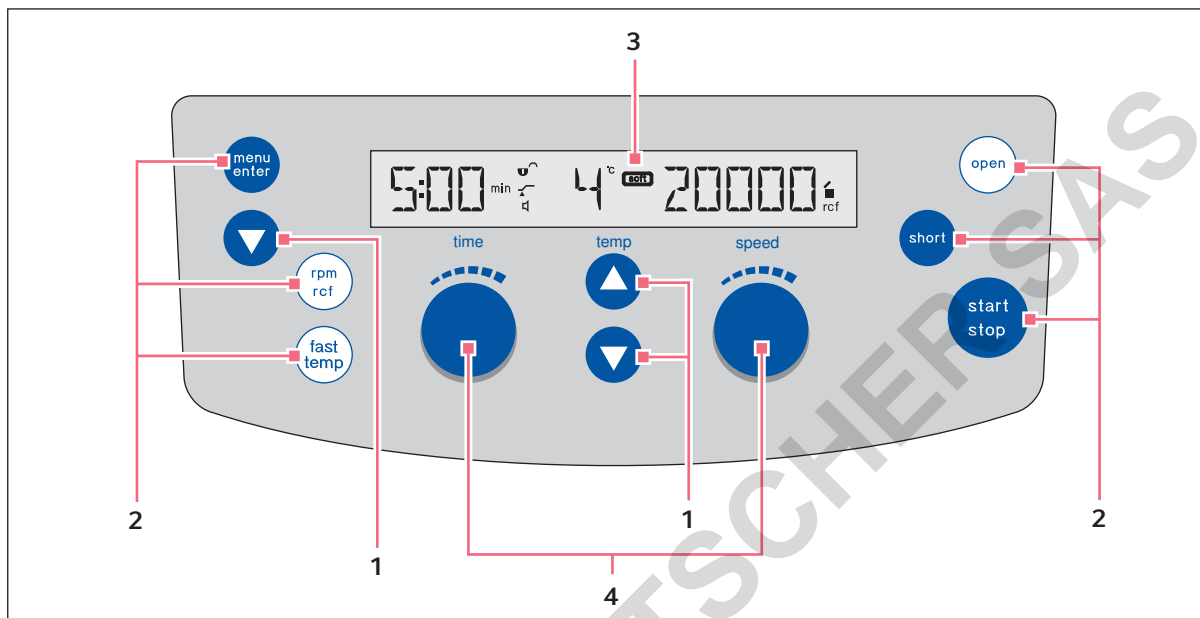











Fig. 3-2: Control panel

- |   |                                  |   |              |
|---|----------------------------------|---|--------------|
| 1 | Navigation keys and setting keys | 3 | Display      |
| 2 | Softkeys                         | 4 | Rotary knobs |

### 3.4.2 Operating controls

Operating control	Function
	Accessing functions Executing the displayed function Navigating to the higher menu level by selecting the <i>Back</i> function
	Toggling the display between speed and relative centrifugal force
	Performing centrifugation with ShortSpin
	Opening the centrifuge lid
	Starting and stopping centrifugation
	Tempering the rotor chamber

Operating control	Function
	Setting the speed of centrifugation
	Setting the centrifugation time
 	Navigating in the software Changing values

### 3.4.3 Display

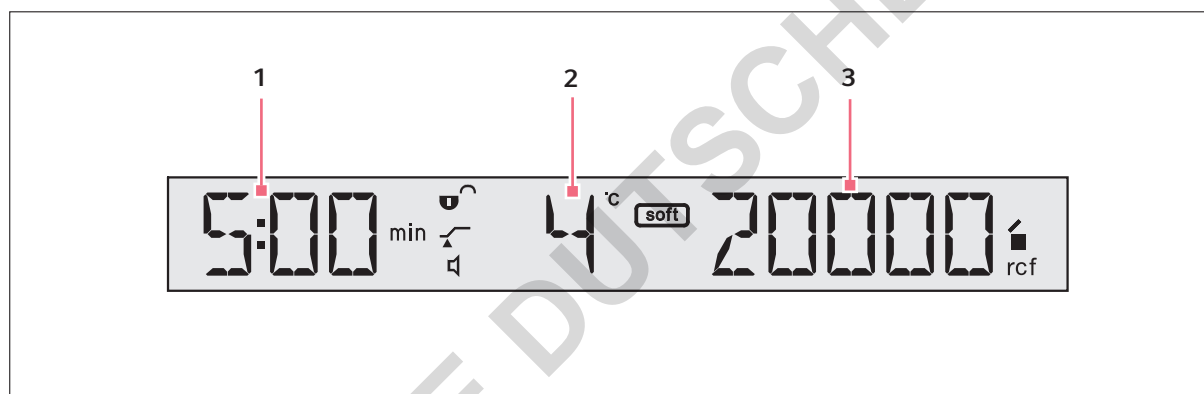







Fig. 3-3: Display of the parameters

- 1 Centrifugation time
- 2 Temperature
- 3 Centrifugation parameters

### 3.4.4 Symbols

Symbol	Description
	The key lock is activated.
	The key lock is deactivated.
	The time measurement for the run starts when 95% of the target speed is reached.
	The time measurement for the run starts at the same time as the centrifugation run.
	The rotor runs slowly and brakes slowly.

**Product description**

Centrifuge 5427 R

English (EN)

Symbol	Description
■	The centrifuge lid is locked.
□	The centrifuge lid is unlocked.
🔊	The signal tone is activated.
🔇	The signal tone is deactivated.

DOMINIQUE DUTSCHER SAS

### 3.5 Name plate

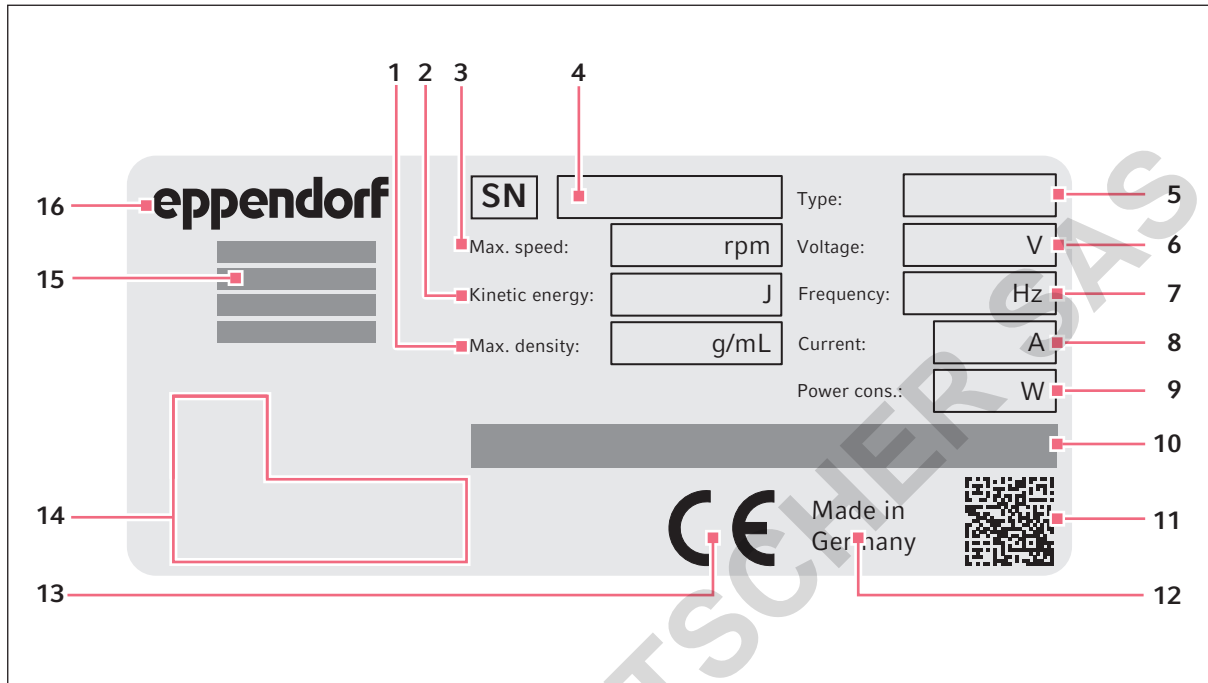











Fig. 3-4: Device identification for Eppendorf SE (example)

- |   |  |    |   |
|---|--|----|---|
| 1 | Maximum density of the material for centrifuging | 9  | Maximum rated power                               |
| 2 | Maximum kinetic energy                           | 10 | Information on the refrigerant                    |
| 3 | Maximum speed                                    | 11 | Data matrix code for serial number                |
| 4 | Serial number                                    | 12 | Designation of origin                             |
| 5 | Product name                                     | 13 | CE marking  |
| 6 | Rated voltage                                    | 14 | Certification marks and symbols (device-specific) |
| 7 | Rated frequency                                  | 15 | Manufacturer's address                            |
| 8 | Maximum rated current                            | 16 | Manufacturer                                      |

#### Certification and conformity marks and symbols (device-specific)

Symbol	Meaning
	Serial number
	Manufacturer's name and address

Symbol	Meaning
	Mark indicating an in-vitro diagnostic device
	Conformity mark for waste electrical and electronic equipment indicating that the devices meet the DIN EN 50419 standard according to the Directive 2012/19/EU of the European Union
	Certification mark indicating that representative samples of the device have been tested by Underwriters Laboratories (UL) against safety standards recognized by the USA and Canada
	Certification mark indicating electromagnetic compatibility in accordance with the requirements of the Federal Communications Commission (FCC, USA)
	Mark indicating conformity with the SJ/T 11364 standard of the People's Republic of China
	Mark indicating that a medical device conforms to the technical regulations of the Eurasian Customs Union
	Mark indicating conformity with all technical regulations of the Eurasian Customs Union
	Mark indicating conformity for the UK economic area

### 3.6 Rotors

#### 3.6.1 Fixed-angle rotor

Each fixed-angle rotor has its specific rotor lid. The rotor designation on the rotor and rotor lid match.

##### **Aerosol-tight fixed-angle rotors**

Distinguishing features:

- Rotor marked with a red ring
- Rotor designation with "FA"
- Red rotor lid screw
- Rotor lid label "aerosol-tight"

- Rotor lid with sealing ring
- Eppendorf QuickLock lid

#### **Non aerosol-tight fixed-angle rotors**

Distinguishing features:

- Rotor designation with "F"
- Black rotor lid screw
- Rotor lid without sealing ring

#### **3.6.2 Swing-bucket rotor**

Each swing-bucket rotor has its specific bucket.

Distinguishing features:

- Rotor cross
- Different buckets
- Rotor designation with "A" or "S"

DOMINIQUE DUTSCHER SAS

## 4 Functional description

### 4.1 Centrifugation runs

You can perform different centrifugation runs:

- A centrifugation with time setting is stopped after the set time.
- A centrifugation without time setting can be stopped individually.
- A centrifugation with ShortSpin is performed as long as you keep the **short** key pressed or if you press it once briefly. During this function, it is not possible to select a temperature. The settings of the acceleration time and deceleration time is not used.

### 4.2 Cooling

Before the centrifugation, a temperature control run can be started to cool the rotor chamber and the accessories.

During the centrifugation, the rotor chamber is cooled to the set temperature.

After the centrifugation, the rotor chamber is cooled for exactly 8 h or without time limit to a minimum of 4 °C with the centrifuge switched on and the lid closed. This temperature prevents:

- Formation of ice
- Condensation
- Freezing of rotor chamber and samples

If the rotor does not rotate, the set temperature is reached more slowly.

-  To quickly cool the rotor chamber, rotor and adapter to the set temperature, start a temperature control run without samples using the FastTemp function. The rotational speed for the temperature control run is determined by the software of the device.

### 4.3 VisioNize Lab Suite

VisioNize Lab Suite is a cloud-based platform.

To send performance data to the VisioNize Lab Suite, for example, you can integrate the device into the local network via the VisioNize box.

For more information, contact your local Eppendorf partner and refer to the VisioNize Lab Suite Setup Guide.

### 4.4 FastTemp function

The FastTemp function is used to immediately start a temperature control run without samples at rotor-specific and temperature-specific speed. This will quickly bring the rotor chamber, including the rotor and the adapter, to the set temperature.

### 4.5 Overview of basic functions

#### Soft ramp

The soft ramp function reduces the speed of the acceleration and braking ramp.

### **Rotor detection**

The rotor is automatically detected when a centrifugation run is started. The device limits the rotational speed of the detected rotor to its maximum speed. Rotor detection can be triggered in two ways.

### **Imbalance detection**

Due to the imbalance detection, the device detects if the rotor is loaded asymmetrically. The device stops the centrifugation and prevents damage to the device and rotor.

### **Key lock**

If the key lock is activated, the centrifugation parameters cannot be changed during centrifugation. If any keys are pressed during centrifugation, the word *SAFE* appears on the display.

### **Signal tone**

The signal tone sounds at the end of the temperature control run and at rotor stop after a centrifugation.

### **Standby mode**

If the device is not used for 15 min, the device switches to standby mode. The letters *EP* appear on the display.

DOMINIQUE DUTSCHER SAS

## 5 Installation

### 5.1 Preparing installation

#### 5.1.1 Checking the delivery

 Do not use the product if the packing or the contents are damaged. In case of damage or missing parts, contact the Eppendorf SE customer service or your Eppendorf partner.

1. Check the packing and the contents for any visible external damage.
2. Check whether the delivery is complete and matches the order.

Quantity	Description
1	Centrifuge as ordered
1	Rotor key
1	Operating manual
1	Condensation water tray

#### 5.1.2 Checking the electrical connection

1. Check whether the electrical connection meets the following requirements:
  - The mains/power connection matches the details on the name plate.
  - An earth/grounded socket with PE conductor is available.
  - A residual current circuit breaker is available and accessible.

All requirements must be fulfilled for the device to be installed and put into operation.

### 5.1.3 Checking the location

1. Check whether the location meets the following criteria:
  - The ambient conditions meet the requirements set out in the “Technical Data” chapter.
  - Minimum room volume: 10 m<sup>3</sup>
  - Minimum clearance to other devices and walls: 50 cm
  - Minimum clearance of the rear of the device to other devices and walls: 30 cm
  - Resonance-free table with a horizontal, even work surface
  - The location is designed to carry the weight of the device
  - Adequate ventilation
  - Non-explosive environment
2. Check whether the location is protected from the following influences:
  - Heat sources
  - Sparks
  - Open flames
  - Direct exposure to sunlight
  - UV radiation
  - Strong electromagnetic radiation

The device must only be installed and put into operation if all the requirements have been met.

### 5.1.4 Unpacking the device

Protective equipment:

- Safety boots

Prerequisites:

- Another transport assistant

1. Transport the device to the intended location.
2. Open the packing.
3. Remove the transport pads.
4. Remove the accessories from the packing.
5. Lift the device out of the packing with two persons. Do not use the opening of the condensation water tray as a handle.
6. Remove the plastic wrapping from the device.

## 5.2 Performing the installation

### 5.2.1 Positioning the device



Do not use the opening of the condensation water tray as a handle.

Protective equipment:

- Safety boots

Prerequisites:

- The location meets the requirements.
- Another transport assistant is available.

1. Place the device in its intended location with the help of another person.
2. Align the device horizontally.
3. Slide the condensation water tray into the holder provided.

### **5.2.2 Connecting the device to the voltage supply**

Prerequisites:

- The device has been positioned in accordance with this manual.
- The device has been acclimatizing for 4 h.

1. Connect the mains/power cord that is permanently attached to the device with the country-specific adapter.
2. Insert the mains/power plug of the country-specific mains/power cord into the earth/grounded socket.
3. Switch on the device using the mains/power switch.

The fan will run at maximum rotational speed for approx. 25 s.

Then the supply voltage is switched on.

The display is active.

The lid of the device opens automatically.

### **5.2.3 Removing the transport securing devices**

1. Remove the transport securing device of the lid latch.
2. Remove the transport securing device of the motor shaft.
3. Slide the condensation water tray into the holder provided.
4. Retain the transport securing device with the original packing of the device.

## 6 Operation

### 6.1 Preparing the device for the application

#### 6.1.1 Selecting the rotor and accessories

1. Select the rotor, adapter and tubes according to your application.
2. Use a rotor lid appropriate for the rotor. Ensure that the rotor designation on the rotor and the rotor lid match.
3. Ensure that rotors, rotor lid and accessories meet the following requirements:
  - Maximum service life not exceeded
  - Intact
  - No corrosion
  - No material changes
  - Undamaged and clean rotor lid seals
4. Make sure the tubes comply with the following requirements:
  - Approved by the manufacturer for this application
  - Chemically resistant to the sample
  - Designed to withstand the intended load
  - Intact
  - No deformation
  - Not brittle

#### 6.1.2 Switching on the device

Prerequisites:

- The device has been set up and connected in accordance with this operating manual.

1. Switch on the device using the mains/power switch.

#### 6.1.3 Opening the centrifuge lid



**CAUTION! Crushing injuries to hands**

When the centrifuge lid falls shut, hand injuries may occur.

- To secure the centrifuge lid against falling shut, open the centrifuge lid completely.

1. Press the **open** key.

The centrifuge lid opens.

2. Unfold the centrifuge lid until the stop.

### 6.1.4 Closing the centrifuge lid



**CAUTION! Crushing injuries to hands**

Risk of hand injuries when closing the centrifuge lid.

- Do not reach into the space between the device and lid.
- Do not reach into the locking mechanism of the centrifuge lid.

1. Push down the centrifuge lid until the lid latch engages and the lid is automatically closed.

The **open** key lights up blue.

### 6.1.5 Replacing the rotor

#### 6.1.5.1 Removing the rotor

Tool:

- Rotor key

1. Loosen the rotor nut by turning the rotor key counterclockwise.
2. Lift the rotor vertically out of the device.

#### 6.1.5.2 Inserting the rotor

Tool:

- Rotor key

Prerequisites:

- A usable rotor is available.

1. Place the rotor vertically on the motor shaft.
2. Tighten the rotor nut by turning the rotor key clockwise.

### 6.1.6 Triggering rotor detection

**Triggering rotor detection manually**



**CAUTION! Risk of hand injuries**

Manually rotating a swing-bucket rotor may cause hand injuries from the rotor cross or the swinging buckets.

- Remove your hands from the rotor cross immediately after attaching the rotor.

Prerequisites:

- The centrifuge lid is open.
- The rotor has been newly inserted.
- The rotor nut is screwed in tightly.

1. Turn the rotor key counterclockwise using your hand.

Rotor detection is triggered.

The name of the rotor appears in the display.

When the device detects the rotor, it checks the nominal speed. If required, the nominal speed is automatically limited to the maximum speed of the inserted rotor.

### Triggering rotor detection with the short key

Prerequisites:

- The rotor has been newly inserted.
- The rotor nut is screwed in tightly.
- The centrifuge lid is closed.

1. Press the **short** key until an indication appears on the display.

Rotor detection is triggered.

The name of the rotor appears in the display.

When the device detects the rotor, it checks the nominal speed. If required, the nominal speed is automatically limited to the maximum speed of the inserted rotor.

### 6.1.7 Opening the rotor lid

#### Opening the rotor lid

1. Turn the lock on the rotor lid counterclockwise.
2. Remove the rotor lid.

### 6.1.8 Closing the rotor lid

#### Rotor lid with screw cap

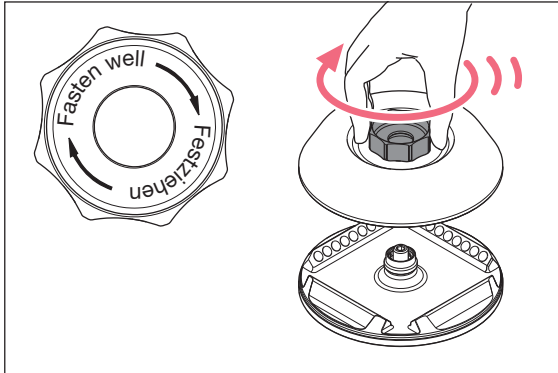

1. Ensure that the rotor designation on the rotor and the rotor lid matches.
2. Place the rotor lid on the rotor.
3. Tighten the rotor lid by turning the screw cap clockwise.

#### Rotor lid with Eppendorf QuickLock lid

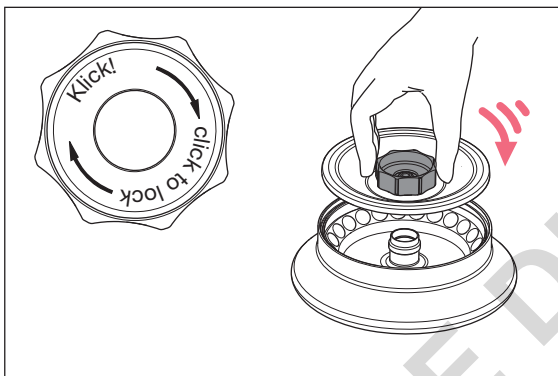

1. Ensure that the rotor designation on the rotor and the rotor lid matches.
2. Check whether the sealing ring is fitted correctly in the rotor lid.
3. Place the rotor lid on the rotor.
4. Turn the lock clockwise until the stop.  
If you hear a click, the rotor is closed correctly.

### 6.1.9 Tempering the rotor chamber with FastTemp

#### Prerequisites:

- The rotor has been inserted and attached correctly.
- The buckets and adapters have been inserted correctly.

- The rotor lid has been mounted correctly.
  - The centrifuge lid is closed.
1. Use the **temp** arrow keys to set the set temperature in the rotor chamber.
  2. Press the **fast temp** key.
    - The temperature control run starts.
    - The display shows *FastTemp*, the set temperature and the current rotational speed.
  3. Wait until the rotor chamber reaches the set temperature.
    - When the rotor chamber has cooled to the set temperature, the temperature control run stops.
    - If activated in the basic settings, a signal tone sounds.
    - After the end of the temperature control run, the set temperature in the rotor chamber is maintained. To prevent ice formation in the rotor chamber, the rotor chamber is cooled to a minimum of 4 °C.



To cancel the temperature control run, press the **start/stop** key.

#### 6.1.10 Adapting the rotor radius

The value for the radius is set to the maximum radius of the rotor.

By default, the conversion from speed to *g*-force is based on the biggest radius of the rotor. If you use an adapter for your tubes, you can manually adapt the value for the radius. The value for the radius of an adapter in a rotor can be found in the technical data of the rotor.

Prerequisites:

- The device has detected the rotor.
1. Press the **menu/enter** key.
  2. Use the menu arrow key to select the *RAD* entry. To confirm the selection, press the **menu/enter** key.
  3. Use the menu arrow key to select the tube volume.
  4. To confirm the selection, press the **menu/enter** key.

The *g*-force (rcf) has been adjusted to the value of the radius.

#### 6.1.11 Preparing tubes



##### **NOTICE! Damage to rotor, accessories and samples**

If the maximum *g*-force is exceeded, glass sample tubes may break and damage the device, accessories and samples.

- Observe the information provided by the tube manufacturer.
- Only use undamaged tubes.

Protective equipment:

- Laboratory protective clothing

Prerequisites:

- The tubes have been checked and are suitable for the centrifugation parameters.
- The adapters are suitable for the tubes.

1. Ensure that the load does not exceed the maximum permissible weight.

Information on this can be found on every rotor and in this operating manual in [Chapter 14 "Suitable rotors"](#) on page 68.

2. Ensure that the filled tubes have the same weight.
3. Ensure that the tube lids are closed.

### 6.1.12 Loading the rotor

#### Loading a fixed-angle rotor



When using different types of tubes, it must be ensured that the rotor is loaded symmetrically.

Prerequisites:

- The tubes are filled.
- The filled tubes have the same weight.

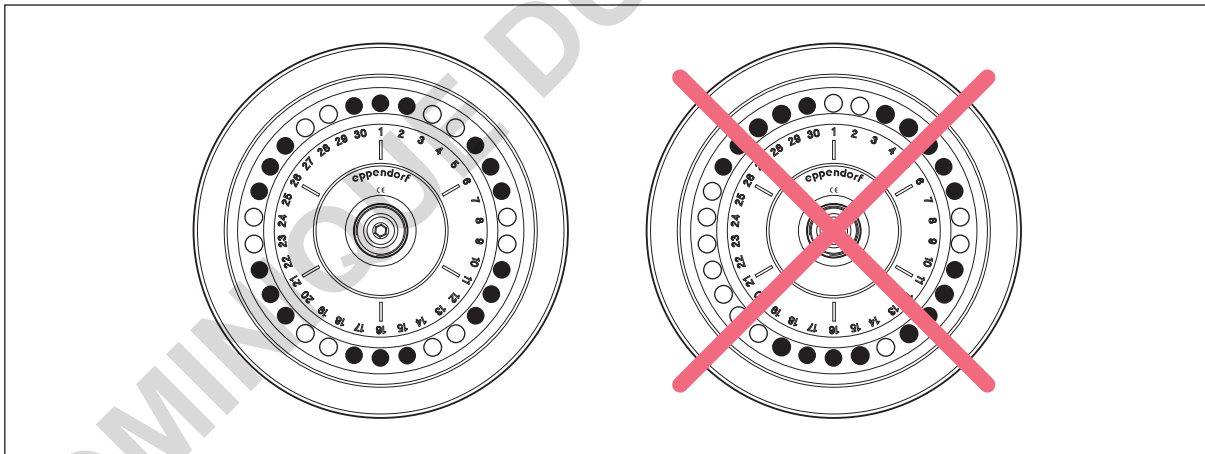

1. If necessary, put the tubes in suitable adapters.
2. Place tubes of the same type and adapter in the rotor bores so that they face each other in pairs.

### Loading fixed-angle rotor FA-45-24-11-Kit with centrifugation columns

Prerequisites:

- The centrifugation columns are filled.
- The filled centrifugation columns have the same weight.

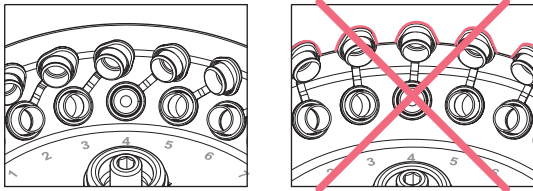

Fig. 6-1: Arrangement of centrifugation columns

1. Lean the open tube lids against the rotor.
2. Ensure that the vessel lids do not protrude beyond the rotor.
3. It is mandatory to put on a suitable rotor lid.

### Loading a swing-bucket rotor

**i** Load adjoining buckets with a maximum of 1100 g difference in weight.

Prerequisites:

- The grooves of the buckets are clean.
- The buckets can swing out freely up to 90° with tubes and plates.
- The tubes are filled.
- The filled tubes are of the same type and have the same weight.

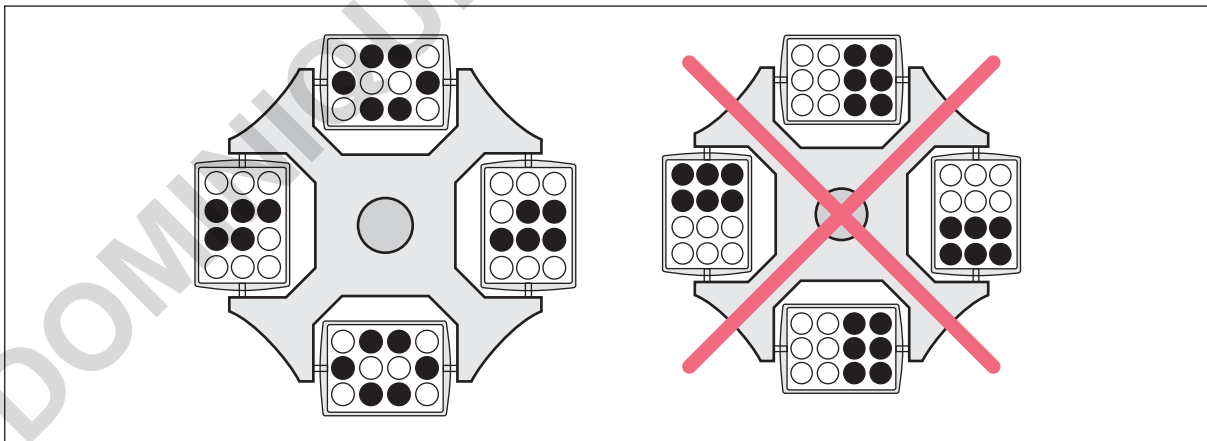

Fig. 6-2: Symmetric loading of the buckets

1. Grease the pegs of the rotor cross if they are not greased.
2. Insert the buckets with the same code number opposite each other into the rotor cross.
3. Ensure that all positions are equipped with buckets.

4. Align the tubes or the plates correctly in the buckets.
5. Load buckets that are located opposite each other with the same weight.
6. Ensure that the buckets can swing out freely.



You can load swing-bucket rotors with different buckets if the buckets are intended for use with the rotor.

## 6.2 Performing a centrifugation

### 6.2.1 Performing a centrifugation with time setting

Prerequisites:

- The device is ready for operation.
  - The rotor has been inserted.
  - The rotor nut is screwed in tightly.
  - The rotor is loaded.
  - The rotor lid is closed.
  - The centrifuge lid is closed.
  - The following settings have been made:
    - Start of the time measurement
    - Cooling time after centrifugation
1. Set the **time** rotary knob to a centrifugation time between 5 s and 9:59 h.
  2. Use the **temp** arrow keys to set the set temperature in the rotor chamber.
  3. Set the nominal speed with the **speed** rotary knob.
  4. Start the centrifugation with the **start/stop** key.
    - The **open** key is no longer lit.
    - The display shows:
      - The remaining centrifugation time
      - Actual values for temperature and rotational speed
      - The flashing **■** symbol

5. Wait until the centrifugation time has elapsed.
  - The centrifugation stops automatically.
  - The rotor brakes until it stops.
  - The display shows:
    - The centrifugation time (flashing)
    - The current temperature in the rotor chamber
    - The flashing ■ symbol
  - If activated in the basic settings, a signal tone sounds several times.
  - The **open** key flashes blue.
  - When the rotor has stopped, the display shows:
    - The time since the rotor stop
    - *oo* after 9:59 h
    - *END*

The rotor chamber is cooled as long as specified in the settings.

6. Open the centrifuge lid using the **open** key.

Cooling of the rotor chamber is finished.

7. Remove the samples.



- To cancel the centrifugation, press the **start/stop** key.
- To toggle the display between rotational speed and *g*-force, press the **rpm/rcf** key.
- You can change the centrifugation time, temperature and speed during the centrifugation.

## 6.2.2 Performing a centrifugation without time setting

Prerequisites:

- The device is ready for operation.
- The rotor has been inserted.
- The rotor nut is screwed in tightly.
- The rotor is loaded.
- The rotor lid is closed.
- The centrifuge lid is closed.
- The following settings have been made:
  - Start of the time measurement
  - Cooling time after centrifugation

1. Use the **time** rotary knob to set the centrifugation time to unlimited by setting the time to < 5 s or > 9:59 h.

The display shows *oo*.

2. Use the **temp** arrow keys to set the set temperature in the rotor chamber.
3. Set the nominal speed with the **speed** rotary knob.

4. Start the centrifugation with the **start/stop** key.
  - The **open** key is no longer lit.
  - The display shows:
    - Actual values for centrifugation time, temperature and speed
    - The flashing ■ symbol
5. Stop the centrifugation with the **start/stop** key.
  - The rotor brakes until it stops.
  - The display shows:
    - The centrifugation time (flashing)
    - The current temperature in the rotor chamber
    - The flashing ■ symbol
  - If activated in the basic settings, a signal tone sounds several times.
  - The **open** key flashes blue.
  - The display shows:
    - The time since the rotor stop
    - oo after 9:59 h
    - *END*

The rotor chamber is cooled as long as specified in the settings.

6. Open the centrifuge lid using the **open** key.

Cooling of the rotor chamber is finished.
7. Remove the samples.



You can change the centrifugation time, temperature and speed during the centrifugation.

### 6.2.3 Performing a centrifugation with ShortSpin

#### Centrifugation after briefly pressing the short key

Prerequisites:

- The rotor has been inserted.
- The rotor nut is screwed in tightly.
- The rotor is loaded.
- The rotor lid is closed.

- The centrifuge lid is closed.
- The speed has been set.

1. Briefly press the **short** key.

- The **open** key is no longer lit.
- The display shows:
  - Actual values for centrifugation time, temperature and speed
  - The flashing ■ symbol

After the rotor has reached the selected rotational speed, the rotor brakes until it stops.

- If activated in the basic settings, a signal tone sounds several times.
- The **open** key flashes blue.
- The display shows:
  - The time since the rotor stop
  - oo after 9:59 h
  - *END*



While the rotor is braking, you can start the centrifugation two more times with ShortSpin by pressing the **short** key.

### Centrifugation with the short key held down

Prerequisites:

- The rotor has been inserted.
- The rotor nut is screwed in tightly.
- The rotor is loaded.
- The rotor lid is closed.
- The centrifuge lid is closed.
- The speed has been set.

1. Hold down the **short** key.

- The **open** key is no longer lit.
- The display shows:
  - Actual values for centrifugation time, temperature and speed
  - The flashing ■ symbol

2. To stop the centrifugation, release the **short** key.

The rotor brakes until it stops.

- If activated in the basic settings, a signal tone sounds several times.
- The **open** key flashes blue.
- The display shows:
  - The time since the rotor stop
  - oo after 9:59 h
  - *END*



While the rotor is braking, you can start the centrifugation two more times with ShortSpin by pressing the **short** key.

## 6.2.4 Switching off the device

Prerequisites:

- The centrifugation run is finished.
- The device lid is open.

1. Switch off the device with the on/off switch.

## 6.3 Advanced settings

### 6.3.1 Activating and deactivating the key lock

#### Activating

1. Press the **menu/enter** key.
2. Select *LOCK > ON* with the menu arrow key.  
The  symbol appears on the display.
3. To confirm the selection, press the **menu/enter** key.

#### Deactivating

1. Press the **menu/enter** key.
2. Select *LOCK > OFF* with the menu arrow key.  
The  symbol appears on the display.
3. To confirm the selection, press the **menu/enter** key.

### 6.3.2 Activating and deactivating the signal tone

#### Activating

1. Press the **menu/enter** key.
2. Select *ALARM > ON* with the menu arrow key.  
The  symbol appears on the display.
3. To confirm the selection, press the **menu/enter** key.

### Deactivating

1. Press the **menu/enter** key.
2. Select *ALARM > OFF* with the menu arrow key.  
The  symbol appears on the display.
3. To confirm the selection, press the **menu/enter** key.

### 6.3.3 Setting the volume of the signal tone

1. Press the **menu/enter** key.
2. Select the *VOL* entry with the menu arrow key.
3. Select one of the levels from *VOL1* to *VOL5*.
4. To confirm the selection, press the **menu/enter** key.

### 6.3.4 Activating/deactivating the standby mode

#### Activating the standby mode

Prerequisites:

- The device is ready for operation.

1. Press the **menu/enter** key.
2. Select *SLEEP > ON* with the menu arrow key.
3. Press the **menu/enter** key.

The standby mode has been activated.



To exit the standby mode, close the centrifuge lid or press a key.

#### Deactivating the standby mode

Prerequisites:

- The device is ready for operation.

1. Press the **menu/enter** key.
2. Select *SLEEP > OFF* with the menu arrow key.
3. Press the **menu/enter** key.

The standby mode has been deactivated.

### 6.3.5 Setting the cooling time after centrifugation

 The cooling time after centrifugation is factory set to 8 h.

#### Setting the cooling time to unlimited



**NOTICE! Damage to the device**

If the rotor chamber is cooled with no time limit after centrifugation, the service life of the compressor will be shortened.

- Set a cooling time limit after centrifugation.

1. Press the **menu/enter** key.
2. Select the *TEMP* entry with the menu arrow key.
3. To set the cooling time after centrifugation to unlimited time, select the  $\infty$  entry.
4. To confirm the selection, press the **menu/enter** key.

#### Setting the cooling time to 1 h, 2 h, 4 h or 8 h

1. Press the **menu/enter** key.
2. Select the *TEMP* entry with the menu arrow key.
3. To set the cooling time after centrifugation to 1 h, 2 h, 4 h or 8 h, select the respective entry *1 h*, *2 h*, *4 h* or *8 h*.
4. To confirm the selection, press the **menu/enter** key.

### 6.3.6 Activating time measurement

#### Activating time measurement without ATSET

1. Press the **menu/enter** key.
2. Select *ATSET > OFF* with the menu arrow key.  
The  symbol appears on the display.  
The time measurement starts at the same time as the centrifugation run.
3. To confirm the selection, press the **menu/enter** key.

#### Activating time measurement with ATSET

1. Press the **menu/enter** key.
2. Select *ATSET > ON* with the menu arrow key.  
The  symbol appears on the display.  
Time measurement starts when 95 % of the nominal speed is reached.
3. To confirm the selection, press the **menu/enter** key.

### 6.3.7 Setting the ShortSpin centrifugation speed

#### Setting the maximum rotational speed

1. Press the **menu/enter** key.
2. Select *SHORT > MAX* with the menu arrow key.
3. To confirm the selection, press the **menu/enter** key.

#### Using preset rotational speed

1. Press the **menu/enter** key.
2. Select *SHORT > SET* with the menu arrow key.
3. To confirm the selection, press the **menu/enter** key.

### 6.3.8 Setting the acceleration time and deceleration time

 This setting is not available for ShortSpin centrifugation.

#### Setting a long acceleration time and deceleration time

1. Press the **menu/enter** key.
2. Select *SOFT > ON* with the menu arrow key.  
The rotor accelerates slowly and brakes slowly.  
The **(soft)** symbol appears on the display.
3. To confirm the selection, press the **menu/enter** key.

#### Setting a short acceleration time and deceleration time

1. Press the **menu/enter** key.
2. Select *SOFT > OFF* with the menu arrow key.  
The rotor accelerates quickly and brakes quickly.
3. To confirm the selection, press the **menu/enter** key.

## 7 Maintenance

### 7.1 Maintenance plan

Interval	Maintenance work
If necessary,	☞ Chapter 7.2.3 "Removing the sealing ring from the rotor lid" on page 43
	☞ Chapter 7.2.4 "Inserting the sealing ring into the rotor lid" on page 44
	☞ Chapter 7.3.2 "Cleaning the device and rotor after glass breakage" on page 45
	☞ Chapter 7.3.3 "Cleaning the condensation water tray" on page 46
	☞ Chapter 7.3.4 "Cleaning the fixed-angle rotor" on page 46
	☞ Chapter 7.3.5 "Cleaning the swing-bucket rotor" on page 47
	☞ Chapter 7.3.6 "Cleaning the accessories" on page 48
Before each use	☞ Chapter 7.3.7 "Autoclaving the rotor and accessories" on page 49
	☞ Chapter 7.2.1 "Checking the device" on page 43
Weekly	☞ Chapter 7.2.2 "Checking the rotor and accessories" on page 43
	☞ Chapter 7.3.4 "Cleaning the fixed-angle rotor" on page 46
50 autoclaving cycles	☞ Chapter 7.3.5 "Cleaning the swing-bucket rotor" on page 47
	☞ Chapter 7.2.3 "Removing the sealing ring from the rotor lid" on page 43
	☞ Chapter 7.2.4 "Inserting the sealing ring into the rotor lid" on page 44

### 7.2 Service

Eppendorf SE recommends having your device inspected and maintained at regular intervals by trained and skilled personnel.

Eppendorf SE offers customized service solutions for preventive maintenance, qualification and calibration of your device. For information, offers and contact options, visit our website [www.eppendorf.com/epservices](http://www.eppendorf.com/epservices).

Eppendorf SE recommends that the device and the associated rotors are serviced by an authorized service technician at least every 12 months. Please note the country-specific regulations.

### 7.2.1 Checking the device

1. Check the device, mains/power cord and motor shaft for visible damage.

If the device is damaged, take it out of operation.

Inform the authorized service technician.

2. Check the rotor chamber for:

- Corrosion
- Ice
- Condensation water

In case of corrosion, recurring ice formation or condensation water in the rotor chamber, inform the authorized service technician.

### 7.2.2 Checking the rotor and accessories

1. Check the rotors and accessories for damage.

Take damaged rotors and damaged accessories out of operation.

2. Check the service life of the rotors and the accessories.

Replace rotors and accessories that have exceeded their service life.

### 7.2.3 Removing the sealing ring from the rotor lid

Tool:

- Paper clips

Material:

- Soap-based cleaning agent
- Cloth
- Water

1. Use the paper clip to lever the sealing ring out of the groove.
2. Remove the sealing ring.
3. Moisten the cloth with water and a cleaning agent.
4. Clean the groove.

## 7.2.4 Inserting the sealing ring into the rotor lid

Material:

- Distilled water
- Pivot grease

Prerequisites

- The sealing ring has been removed from the rotor lid.
- A new, undamaged sealing ring is available.

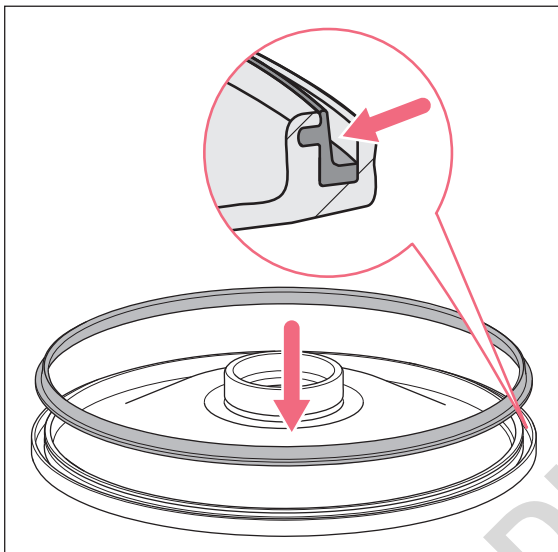

1. Moisten the new sealing ring with distilled water.
2. Position the sealing ring on the groove.
3. Press the sealing ring into the groove so that it does not protrude at any point.
4. Let the sealing ring dry.
5. Check whether the sealing ring is inserted correctly.
6. Apply a thin layer of pivot grease to the sealing ring.

## 7.2.5 Documenting the service life

The service life of rotors, rotor lids and accessories may be limited. Information on how long you may use rotors, rotor lids and accessories can be found in the technical data.

1. Document the following data for rotors, rotor lids and accessories:
  - Date of initial setup
  - Number of centrifugation cycles
  - Number of autoclaving cycles

## 7.3 Cleaning

### 7.3.1 Cleaning a contaminated device

**i** Do not grease the motor shaft.



**NOTICE! Damage to components**

If disinfectant gets inside the device, it can cause electronic components to corrode. This will impair the function of the device.

- Do not spray disinfectant directly onto plugs or into openings in the device.
- Only spray moderate amounts of disinfectant onto surfaces.

Protective equipment:

- Laboratory protective clothing

Material:

- Water
- Soap-based cleaning agent
- Cloth
- Brush
- Care product

Prerequisites:

- The device has been disconnected from the mains/power supply.
- The centrifuge lid is open.
- The rotor has been removed from the device.

1. Clean the ventilation gaps of the housing with a paintbrush or small brush.
2. Wet the cloth with cleaning agent.
3. Clean all accessible surfaces including the mains/power cord with the damp cloth.
4. Thoroughly clean the rubber seals with water.
5. Clean the motor shaft with a dry cloth.
6. Allow the device to dry with the lid open.
7. Apply care product to the rubber seals, e.g., glycerol.

### 7.3.2 Cleaning the device and rotor after glass breakage

Protective equipment:

- Laboratory protective clothing

Material:

- Water
- Cloth

Prerequisites:

- The device has been disconnected from the mains/power supply.

1. Remove all glass splinters.
2. Remove the rotor and the accessories.
3. Use moist cloths to clean the rotor chamber.

4. Rinse the rotor and the accessories thoroughly with water.
5. Thoroughly clean the bores of the fixed-angle rotors.
6. Replace the adapters to prevent any further damage.
7. Allow the rotor and the accessories to dry.
8. Allow the device to dry with the lid open.

### 7.3.3 Cleaning the condensation water tray

Protective equipment:



- Laboratory protective clothing

Material:

- Water
- Cloth

1. Pull the condensation water tray out of the device.
2. Empty the condensation water tray.
3. Rinse the condensation water tray with water.
4. Dry the condensation water tray with a cloth.
5. Place the condensation water tray into the device.

### 7.3.4 Cleaning the fixed-angle rotor

-  When cleaning the rotor, do not immerse it. Liquid may enter the cavities.
-  Do not grease the rotor cone.

Protective equipment:

- Laboratory protective clothing

Material:

- Water
- Distilled water
- Soap-based cleaning agent
- Disinfectant with at least 70 % ethanol
- Cloth
- Cleaning brush
- Pivot grease

Prerequisites:

- The rotor has been removed from the device.
1. Moisten the cloth with water and a cleaning agent.
  2. Clean the rotor lid.
  3. Disinfect the rotor lid.
  4. Rinse the rotor lid with distilled water.
  5. Place the rotor lid on a cloth to dry.
  6. Slightly grease the pegs in the lid screw of the aerosol-tight rotor lid with pivot grease.
  7. Clean the rotor.
  8. Moisten the cleaning brush with water and a cleaning agent.
  9. Clean the rotor bores with the cleaning brush.
  10. Thoroughly rinse the rotor bores with water.
  11. Disinfect the rotor and the rotor bores.
  12. Rinse the rotor with distilled water.
  13. Place the rotor on a cloth to dry with the openings facing downwards.
  14. Clean the rotor cone with a dry cloth.

### 7.3.5 Cleaning the swing-bucket rotor

 When cleaning the rotor, do not immerse it.

 Do not grease the rotor cone.

Protective equipment:

- Laboratory protective clothing

Material:

- Water
- Distilled water
- Soap-based cleaning agent
- Disinfectant with at least 70 % ethanol
- Cloth
- Pivot grease

Prerequisites

- The rotor has been removed from the device.
1. Moisten the cloth with water and a cleaning agent.
  2. Clean the rotor, the rotor pivots and the buckets.
  3. Disinfect the rotor, the rotor pivots and the buckets.
  4. Rinse the rotor, the rotor pivots and the buckets with distilled water.
  5. Place the rotor and the buckets on a cloth to dry.
  6. Clean the rotor cone with a dry cloth.
  7. Lightly grease the rotor pivot with pivot grease.

### **7.3.6 Cleaning the accessories**

Protective equipment:

- Laboratory protective clothing

Material:

- Water
  - Distilled water
  - Soap-based cleaning agent
  - Disinfectant with at least 70 % ethanol
  - Cloth
1. Moisten the cloth with water and a cleaning agent.
  2. Clean the accessories.
  3. Disinfect the accessories.
  4. Rinse the accessories with distilled water.
  5. Place the accessories on a cloth to dry.

### 7.3.7 Autoclaving the rotor and accessories

The following components are autoclavable:

- All rotors of the device
- Adapters

 Replace the sealing rings of the aerosol-tight rotor lid after 50 autoclaving cycles.

Protective equipment:

- Laboratory protective clothing
1. Autoclave at 121 °C for 20 min.
  2. Apply a thin layer of pivot grease to the pegs in the latch of the rotor lid.

### 7.4 Care instructions

- Clean the condensation water tray regularly, especially after liquid spillage in the rotor chamber.
- Leave the centrifuge lid open when not in use for a long period.
- Remove condensation water from the rotor chamber.

## 8 Troubleshooting

### 8.1 General errors

Error description	Cause	Solution
No display	Mains/power outage	Check: <ul style="list-style-type: none"> <li>The mains/power fuse of the lab</li> </ul>
	The device is not supplied with voltage.	Check: <ul style="list-style-type: none"> <li>The mains/power cord.</li> </ul>
The centrifuge lid cannot be opened.	The rotor is running.	Wait for the rotor to stop. Then open the centrifuge lid.
	Mains/power outage	Check: <ul style="list-style-type: none"> <li>The mains/power fuse of the lab</li> </ul> Open the centrifuge lid with the emergency release.
The device does not start.	The centrifuge lid is open.	Close the centrifuge lid.
The device shakes when it starts up.	The rotor is asymmetrically loaded.	Stop the centrifugation. Load the rotor symmetrically. Restart the centrifugation.
The rotor brakes although the <b>short</b> key is pressed.	The <b>short</b> key was released briefly at least twice. The protective function for the drive is triggered.	Press the <b>short</b> key continuously.
The temperature display flashes.	The device has not reached the set temperature. The difference between the actual temperature and the set temperature is $> 3\text{ }^{\circ}\text{C}$ .	Check: <ul style="list-style-type: none"> <li>The set temperature</li> </ul> Wait until the device reaches the set temperature. Switch off the device. Allow the device to cool down for at least 15 min. Ensure free air circulation through the ventilation gaps. If necessary, free the rotor chamber from ice. Pre-temper the rotor chamber and the accessories with the FastTemp function.
There is black metal abrasion in the rotor chamber.	The tubes in the rotor are too long.	Clean the device. Use tubes that are suitable for the rotor.

Error description	Cause	Solution
There is black metal abrasion in the rotor chamber.	The permissible rotational speed of the tubes has been exceeded.	Clean the device. Use tubes that are approved for the required rotational speed.
There is ice in the rotor chamber.	The humidity in the rotor chamber is too high and the minimum temperature is too low.	Perform a temperature control run at approx. 30 °C. Wipe up condensation water with an absorbent cloth. Leave the device with the centrifuge lid open.
"no rotor" is shown on the display and the centrifugation cannot be started.	The rotor is not detected by the rotor detection.	If the device does not detect the rotor, use a different rotor. If other rotors are not detected, contact an authorized service technician.

If you cannot remedy an error with the recommended measures, please contact your local Eppendorf partner. The address can be found on the Internet at [www.eppendorf.com](http://www.eppendorf.com).

## 8.2 Error message of the software

Error description	Cause	Solution
<i>ERR 1</i>	The rotational speed measurement system works incorrectly.	Check the rotor. If this messages appears again, check the device with a different rotor.
	The rotor is not detected.	Check the rotor. If this messages appears again, check the device with a different rotor.
<i>ERR 2</i>	The imbalance detection is defective.	Switch off the device. Switch the device back on after at least 20 s.
<i>NO RPM (ERR 3)</i>	The rotational speed measurement system is defective. The drive is defective.	Leave the device switched on until the error message disappears after 10 s to 6 min.
<i>ERR 5</i>	The user tried to open the centrifuge lid during the centrifugation	Wait for the rotor to stop.
<i>ERR 6</i>	The drive electronics works incorrectly.	Repeat the centrifugation. If this message appears again, switch off the device. Switch the device back on after at least 20 s.

<b>Error description</b>	<b>Cause</b>	<b>Solution</b>
<i>ERR 6</i>	The drive is overheated.	Repeat the centrifugation.  If this message appears again, switch off the device.  Switch the device back on after at least 20 s.
<i>ERR 7</i>	The nominal speed and the actual rotational speed deviate from each other.	Wait for the rotor to stop.  Tighten the rotor nut.
<i>ERR 8</i>	The rotor is not attached correctly.	Wait for the rotor to stop.  Tighten the rotor nut.  Repeat the centrifugation.
	The rotational speed measurement system is defective.	Wait for the rotor to stop.  Tighten the rotor nut.  Repeat the centrifugation.
<i>ERR 9 to ERR 14</i>	The electronics works incorrectly	Switch off the device.  Switch the device back on after at least 20 s.
<i>IMBAL (ERR 15)</i>	The rotor is asymmetrically loaded.	Load the rotor symmetrically.  Balance the rotor.
<i>ERR 16 to ERR 17</i>	The electronics works incorrectly	Switch off the device.  Switch the device back on after at least 20 s.
<i>ERR 18</i>	The difference between the actual temperature and the set temperature in the rotor chamber is > 5 °C.	Check: <ul style="list-style-type: none"> <li>• The set temperature</li> </ul> Switch off the device.  Allow the device to cool down for approx. 15 min.  Ensure free air circulation through the ventilation gaps.  Free the rotor chamber from ice.
<i>ERR 19</i>	The condenser is overheated.	Allow the device to cool down.  Ensure free air circulation through the ventilation gaps.
<i>ERR 20</i>	The temperature sensor in the rotor chamber works incorrectly.	Switch off the device.

Error description	Cause	Solution
<i>ERR 20</i>	The temperature sensor in the rotor chamber works incorrectly.	Switch the device back on after at least 20 s.
<i>ERR 21</i>	The temperature sensor at the condenser works incorrectly.	Switch off the device. Switch the device back on after at least 20 s.
<i>ERR 22</i>	The electronics works incorrectly	Switch off the device. Switch the device back on after at least 20 s.
<i>NO AC POWER (ERR 22.1)</i>	The electronics works incorrectly	Switch off the device. Switch the device back on after at least 20 s.
<i>ERR ST ARTUP (ERR 22.3)</i>	The electronics works incorrectly	Switch off the device. Switch the device back on after at least 20 s.
<i>ERR 23</i>	The electronics works incorrectly	Switch off the device. Switch the device back on after at least 20 s.
<i>ERR 24</i>	The compressor works incorrectly.	Allow the device to cool down. Repeat the centrifugation.
<i>INT (ERR 25)</i>	The electrical service was interrupted during the run.	Check: <ul style="list-style-type: none"> <li>• The mains/power connection</li> </ul>
<i>ERR 27</i>	Data communication is defective.	Switch off the device. Switch the device back on after 20 s.
<i>ERR 28</i>	The speed check is incorrect.	Switch off the device. Switch the device back on after at least 20 s.
<i>SPEED (ERR 29)</i>	The set g-force/speed is too high, e.g. after a rotor change.	Check: <ul style="list-style-type: none"> <li>• The g-force/speed</li> </ul> Repeat the centrifugation.
<i>LID (ERR 30)</i>	The centrifuge lid cannot be locked.	Close the centrifuge lid. Switch off the device. Switch the device back on after at least 20 s. Press the <b>open</b> key.

Error description	Cause	Solution
<i>LID (ERR 30)</i>	The centrifuge lid cannot be locked.	If this message appears again, switch off the device.  Actuate the emergency release.
	The centrifuge lid cannot be unlocked.	Close the centrifuge lid.  Switch off the device.  Switch the device back on after at least 20 s.  Press the <b>open</b> key.  If this message appears again, switch off the device.  Actuate the emergency release.
<i>ERR 36</i>	The device is initialized incorrectly.	Contact an authorized service technician.
<i>OFF</i>	The device is switched off.	–

If you cannot remedy an error with the recommended measures, please contact your local Eppendorf partner. The address can be found on the Internet at [www.eppendorf.com](http://www.eppendorf.com).

### 8.3 Emergency release of the centrifuge lid

 Only actuate the emergency release in an emergency.



#### **CAUTION! Risk of hand injuries**

If the emergency release of the lid is used, the rotor may continue to rotate. Reaching into the rotor chamber while the rotor is still rotating may cause hand injuries.

- Wait for the rotor to stop moving.
- Grasp the rotor or reach into the rotor chamber only after this.

Tool:

- Rotor key

Prerequisites:

- The rotor is stationary.
- The device has been disconnected from the mains/power supply.
- The cover of the emergency release has been removed by means of a screwdriver.

1. Insert the rotor key into the opening of the emergency release until a resistance is felt.
2. Press the rotor key against this resistance. At the same time turn the rotor key in the direction of the arrow.

The centrifuge lid is unlocked and pops open a little.

3. Open the centrifuge lid.
4. Remove the rotor key.

DOMINIQUE DUTSCHER SAS

## **9 Shut down**

### **9.1 Disconnecting the device from the voltage supply**

#### Prerequisites

- The device has been switched off.
1. Disconnect the mains/power plug from the earth/grounded socket.

DOMINIQUE DUTSCHER SAS

## 10 Transport

### 10.1 Preparing the device for transport

Prerequisites:

- The device has been taken out of operation.

1. Remove the rotor from the device.
2. Close the centrifuge lid.

### 10.2 Transporting the device



#### **WARNING! Personal injury**

The device is heavy. Improper lifting and moving of the device can lead to injury.

- Transport the device with at least two transport assistants.
- Transport the device with a suitable transport aid, e.g. a mobile table.

Protective equipment:

- Safety boots

Material:

- Transport aid

Prerequisites:

- A sufficient number of transport assistants is available.

1. Transport the device in an upright position. Use a transport aid, e.g. a mobile table.
2. Avoid vibrations of the device.

### 10.3 Shipping the device



Use the original packing to transport the device. If the original packing is no longer available, please ensure that the device is sufficiently protected by replacement packing during storage and further transport. Eppendorf SE is not liable for damage caused by improper replacement packing.



#### **WARNING! Contamination**

Shipping or storing a contaminated device may lead to contamination of persons or cause damage to health.

- Clean and decontaminate the device before shipping it or putting it into storage.

Material:

- Packing

Prerequisites:

- The device has been taken out of operation.
  - The device has been cleaned and decontaminated.
1. Download the decontamination certificate for product returns from the webpage [www.ependorf.com](http://www.ependorf.com).
  2. Complete the decontamination certificate.
  3. Pack the device.
  4. Attach the decontamination certificate to the outside of the packing so that it is safe for transport.
  5. Ship the device.

DOMINIQUE DUTSCHER SAS

## 11 Storage

### 11.1 Storing accessories

1. Store rotors with the rotor lid open.
2. Do not store rotors, rotor lids and accessories in areas with strong UV radiation.

DOMINIQUE DUTSCHER SAS

## 12 Disposal

### 12.1 Legal requirements

#### EU countries

In the EU member states, electrical and electronic equipment must be disposed of in accordance with directive 2012/19/EU. This directive has been transposed into national law by all EU member states.

Electrical and electronic equipment which has been put on the market after August 13, 2005 must be marked in a special way. According to the European standard DIN EN 50419 the following symbol can be used to mark this equipment:

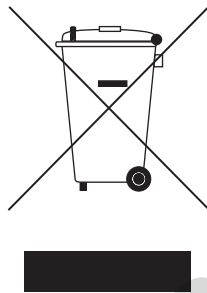

In the EU member states, batteries and rechargeable batteries must be disposed of in accordance with directive 2006/66/EC. This directive has been transposed into national law by all EU member states.

#### Non-EU countries

Non-EU countries have country-specific standards for the disposal of waste electrical and electronic equipment and the disposal of batteries and rechargeable batteries.

### 12.2 Disposal in the target market

### 12.3 Preparing for disposal

#### Preparing disposal in accordance with legal regulations

 For information on the legal regulations that apply in your country, please contact your local competent authority or your Eppendorf partner.

 Dispose of non-decontaminable devices as hazardous waste.



#### **CAUTION! Fire hazard or explosion hazard**

The device contains a flammable refrigerant. If the refrigerants used come into contact with sparks, they will ignite. Persons may be injured.

- Dispose of the device properly in accordance with national or local regulations.

1. Check the applicable legal requirements for disposal in your country.
2. Select a certified disposal company or contact your Eppendorf partner.

#### **Removing batteries and rechargeable batteries**

1. Check whether your device contains permanently installed batteries or rechargeable batteries.
2. Only remove the batteries and rechargeable batteries that are not permanently installed.
3. Dispose of the removed batteries and rechargeable batteries in accordance with the legal regulations of your country.

#### **Creating a decontamination certificate**

Prerequisite:

- The device has been decontaminated.

1. Download a decontamination certificate from our webpage [www.eppendorf.com](http://www.eppendorf.com).
2. Complete the decontamination certificate.

### **12.4 Handing over the device to the disposal company**

1. Inform the disposal company of any hazards posed by the device, e.g., locking devices, flammable substances.
2. Hand over the device and the decontamination certificate to the certified disposal company.

## 13 Technical data

### 13.1 Dimensions

Width	319 mm
Length	540 mm
Height with lid closed	254 mm
Height with lid open	557 mm

### 13.2 Weight

#### Device

Device without rotor	30 kg
Packing	3.2 kg

#### Rotors

F-45-48-11	1770 g
FA-45-48-11	2110 g
FA-45-30-11	1500 g
F-45-30-11	1020 g
FA-45-24-11	1290 g
FA-45-24-11-Kit	1600 g
FA-45-12-17	2090 g
F-45-48-5-PCR	850 g
S-24-11-AT	1340 g
(Buckets without caps)	27 g

### 13.3 Mains/power supply

Mains/power connection	220 V – 240 V, 50 Hz – 60 Hz 120 V, 50 Hz – 60 Hz 100 V, 50 Hz – 60 Hz
Current consumption	220 V – 240 V/2.3 A 120 V/4.4 A 100 V/5.0 A
Power consumption	495 W

Electromagnetic compatibility Noise emission (radio interference)	The device meets the following requirements: 220 V – 240 V: <ul style="list-style-type: none"> <li>• IEC 61326-1 (CISPR 11)</li> <li>• DIN EN 61326-1: 2013-07</li> <li>• DIN EN 55011 – Class B</li> </ul> 120 V: <ul style="list-style-type: none"> <li>• IEC 61326-1 (CISPR 11) – Class B</li> <li>• CFR 47 FCC Part 15 – Class B</li> </ul> 100 V: <ul style="list-style-type: none"> <li>• IEC 61326-1 (CISPR 11) – Class B</li> </ul>
Electromagnetic compatibility Noise immunity	The device meets the following requirements: <ul style="list-style-type: none"> <li>• IEC 61326-1</li> <li>• DIN EN 61326-1</li> </ul>
Fuses Fuses may only be replaced by an authorized service technician.	220 V – 240 V: 4 AT 120 V: 8 AT 100 V: 10 AT
Overvoltage category	II
Pollution degree	2

### 13.4 Refrigeration system

Refrigerant	R290 (75 g)
-------------	-------------

### 13.5 Ambient conditions

#### Operation

Ambience	For indoor use only
Ambient temperature	10 °C – 35 °C
Relative humidity	10 % – 75 %, non-condensing
Atmospheric pressure	79.5 kPa – 106 kPa
Room volume (air volume at the location)	10 m <sup>3</sup>
Clearance to other devices and walls	50 cm
Clearance between the rear of the device and other devices and walls	30 cm

### General transport and airfreight

Air temperature	-25 °C – 60 °C
Relative humidity	10 % – 75 %
Atmospheric pressure	30 kPa – 106 kPa

### Storage

Air temperature	-5 °C – 45 °C
Relative humidity	10 % – 75 %
Atmospheric pressure	70 kPa – 100 kPa
Room volume (air volume at the storage location)	10 m <sup>3</sup>

### 13.6 Interfaces

Interface for software updates	USB-B
--------------------------------	-------

### 13.7 Noise level

Device	<56 dBA
--------	---------

### 13.8 Acceleration and deceleration times

The following table contains the acceleration and deceleration times for the rotors of the centrifuge. The details were determined with the rotor at maximum load, for swing-bucket rotors with a round bucket. Fluctuations may occur depending on the condition of the device and the load.

Rotor	Acceleration time		Voltage		
	Deceleration time		220 V–240 V	120 V	100 V
FA-45-12-17	Without soft ramp	Acceleration time	≤27 s	≤29 s	≤29 s
		Deceleration time	≤24 s	≤25 s	≤25 s
	With soft ramp	Acceleration time	≤39 s	≤39 s	≤39 s
		Deceleration time	≤39 s	≤39 s	≤39 s
FA-45-24-11	Without soft ramp	Acceleration time	≤18 s	≤19 s	≤19 s
		Deceleration time	≤18 s	≤19 s	≤19 s

Rotor	Acceleration time		Voltage		
	Deceleration time		220 V–240 V	120 V	100 V
	With soft ramp	Acceleration time	≤29 s	≤29 s	≤29 s
		Deceleration time	≤31 s	≤31 s	≤31 s
FA-45-24-11-Kit	Without soft ramp	Acceleration time	≤21 s	≤22 s	≤22 s
		Deceleration time	≤21 s	≤21 s	≤21 s
	With soft ramp	Acceleration time	≤32 s	≤32 s	≤32 s
		Deceleration time	≤31 s	≤31 s	≤31 s
FA-45-30-11	Without soft ramp	Acceleration time	≤21 s	≤22 s	≤22 s
		Deceleration time	≤18 s	≤19 s	≤19 s
	With soft ramp	Acceleration time	≤32 s	≤32 s	≤32 s
		Deceleration time	≤33 s	≤33 s	≤33 s
F-45-30-11	Without soft ramp	Acceleration time	≤21 s	≤22 s	≤22 s
		Deceleration time	≤18 s	≤19 s	≤19 s
	With soft ramp	Acceleration time	≤29 s	≤29 s	≤31 s
		Deceleration time	≤32 s	≤32 s	≤32 s
FA-45-48-11	Without soft ramp	Acceleration time	≤28 s	≤29 s	≤29 s
		Deceleration time	≤22 s	≤23 s	≤23 s
	With soft ramp	Acceleration time	≤36 s	≤36 s	≤39 s
		Deceleration time	≤35 s	≤35 s	≤35 s

Rotor	Acceleration time		Voltage		
	Deceleration time		220 V–240 V	120 V	100 V
F-45-48-11	Without soft ramp	Acceleration time	≤28 s	≤29 s	≤29 s
		Deceleration time	≤22 s	≤23 s	≤23 s
	With soft ramp	Acceleration time	≤36 s	≤36 s	≤36 s
		Deceleration time	≤35 s	≤35 s	≤35 s
F-45-48-PCR	Without soft ramp	Acceleration time	≤11 s	≤12 s	≤12 s
		Deceleration time	≤12 s	≤13 s	≤13 s
	With soft ramp	Acceleration time	≤22 s	≤22 s	≤22 s
		Deceleration time	≤22 s	≤22 s	≤22 s
S-24-11-AT	Without soft ramp	Acceleration time	≤18 s	≤18 s	≤18 s
		Deceleration time	≤17 s	≤17 s	≤17 s
	With soft ramp	Acceleration time	≤29 s	≤29 s	≤29 s
		Deceleration time	≤30 s	≤30 s	≤30 s

### 13.9 Application parameters

Time	5 s – 9:59 h, infinite (∞) <ul style="list-style-type: none"> <li>• 5 s – 1 min : can be set in increments of 5 s</li> <li>• 1 min – 2 min: can be set in increments of 10 s</li> <li>• 2 min – 10 min: can be set in increments of 30 s</li> <li>• 10 min – 9:59 h: can be set in increments of 1 min</li> </ul>
Temperature	-11 °C – +40 °C
Speed	100 rpm – 16220 rpm: can be set in increments of 50 rpm
Relative centrifugal force	1 x g – 25001 x g

Maximum load	48 micro test tubes with a volume of 2.0 mL
Maximum kinetic energy	9920 J
Permitted density of the material for centrifuging at maximum rotational speed and maximum load	1.2 g/mL
Compulsory testing in Germany	no

 Aerosol-tight rotors, rotor lids and buckets are certified to IEC 61010-2-020.

### 13.10 Service life of rotors, rotor lids and accessories

Eppendorf SE states the service life in cycles and years. If you cannot determine the number of cycles, use the service life in years.

Rotor, rotor lid and accessories	Service life from first use	
	In cycles	In years
FA-45-12-17	100000	15 years
FA-45-48-11	100000	15 years
S-24-11-AT	100000	7 years
QuickLock rotor lids	-	3 years
Seals of the QuickLock rotor lids	50 autoclaving cycles	-
Rotor lids and caps made from polycarbonate (PC), polypropylene (PP) or polyetherimide (PEI)	50 autoclaving cycles	3 years
Adapter	-	1 year







## 14 Suitable rotors

Centrifuges from Eppendorf SE can only be operated with rotors that are intended for use with the device.

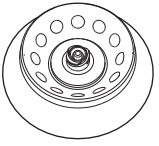
Please note the manufacturer's information on the centrifugation stability of the sample tubes (maximum *g*-force).

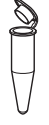
### 14.1 Rotor FA-45-12-17

Aerosol-tight fixed-angle rotor for 12 reaction tubes









Rotor FA-45-12-17				
	Max. <i>g</i> -force:		20598 × <i>g</i>	
	Max. speed:		14000 rpm	
	Max. weight in the rotor (adapter, tube and contents):		12 × 9.5 g	
Tube	Tube Capacity Tubes per adapter/rotor	Adapter Order no. (international)	Bottom shape Diameter	Max. <i>g</i> -force Max. speed Radius
	Micro test tube 5 mL –/12	–	– Ø 17 mm	20598 × <i>g</i> 14000 rpm 9.4 cm
	Micro test tube 1.5 mL/2 mL 1/12	 5820 768 002	Open Ø 11 mm	17530 × <i>g</i> 14000 rpm 8.0 cm
	HPLC vial 1/12	 5820 770 007	Flat Ø 11 mm	16215 × <i>g</i> 14000 rpm 7.4 cm
	Cryogenic tube 1.0 mL/2 mL 1/12	 5820 769 009	Flat Ø 13 mm	18188 × <i>g</i> 14000 rpm 8.3 cm

### 14.2 Rotor FA-45-24-11

Aerosol-tight fixed-angle rotor for 24 tubes

**Rotor FA-45-24-11**

	Max. <i>g</i> -force:	25001 × <i>g</i>
	Max. speed:	16220 rpm
	Max. weight in the rotor (adapter, tube and contents):	24 × 3.75 g







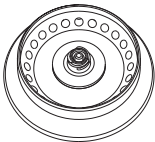

Tube	Tube Capacity Tubes per adapter/rotor	Adapter Order no. (international)	Bottom shape Diameter	Max. <i>g</i> -force Max. speed Radius
	Micro test tube 1.5 mL/2 mL -/24	–	– Ø 11 mm	25001 × <i>g</i> 16220 rpm 8.5 cm
	PCR tube 0.2 mL 1/24	 5425 715 005	Conical Ø 6 mm	18825 × <i>g</i> 16220 rpm 6.4 cm
	Micro test tube 0.4 mL 1/24	 5425 717 008	Conical Ø 6 mm	25001 × <i>g</i> 16220 rpm 8.5 cm
	Micro test tube 0.5 mL 1/24	 5425 716 001	Open Ø 8 mm	21766 × <i>g</i> 16220 rpm 7.4 cm
	Microtainers 0.6 mL 1/24	 5425 716 001	Open Ø 8 mm	25001 × <i>g</i> 16220 rpm 8.5 cm

**14.3 Rotor FA-45-24-11-Kit**

Aerosol-tight fixed-angle rotor for 24 tubes

### Rotor FA-45-24-11-Kit

	Max. <i>g</i> -force:	19090 × <i>g</i>
	Max. speed:	13200 rpm
	Max. weight in the rotor (adapter, tube and contents):	24 × 3.75 g







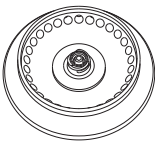

Tube	Tube Capacity Tubes per adapter/rotor	Adapter Order no. (international)	Bottom shape Diameter	Max. <i>g</i> -force Max. speed Radius
	Micro test tube 1.5 mL/2 mL -/24	–	– Ø 11 mm	19090 × <i>g</i> 13200 rpm 9.8 cm
	PCR tube 0.2 mL 1/24	 5425 715 005	Conical Ø 6 mm	15000 × <i>g</i> 13200 rpm 7.7 cm
	Micro test tube 0.4 mL 1/24	 5425 717 008	Conical Ø 6 mm	19090 × <i>g</i> 13200 rpm 9.8 cm
	Micro test tube 0.5 mL 1/24	 5425 716 001	Open Ø 8 mm	16948 × <i>g</i> 13200 rpm 8.7 cm
	Microtainers 0.6 mL 1/24	 5425 716 001	Open Ø 8 mm	19090 × <i>g</i> 13200 rpm 9.8 cm

### 14.4 Rotor FA-45-30-11 and F-45-30-11

Aerosol-tight fixed-angle rotor and fixed-angle rotor for 30 micro test tubes.

**Rotor F-45-48-5-PCR**

	Max. <i>g</i> -force:	20817 × <i>g</i>
	Max. speed:	14000 rpm
	Max. weight in the rotor (adapter, tube and contents):	30 × 3.75 g







Tube	Tube Capacity Tubes per adapter/rotor	Adapter Order no. (international)	Bottom shape Diameter	Max. <i>g</i> -force Max. speed Radius
	Micro test tube 1.5 mL/2.0 mL -/30	-	- Ø 11 mm	20817 × <i>g</i> 14000 rpm 9.5 cm
	PCR tube 0.2 mL 1/30	 5425 715 005	Conical Ø 6 mm	16215 × <i>g</i> 14000 rpm 7.4 cm
	Micro test tube 0.4 mL 1/30	 5425 717 008	Conical Ø 6 mm	20817 × <i>g</i> 14000 rpm 9.5 cm
	Micro test tube 0.5 mL 1/30	 5425 716 001	Open Ø 8 mm	18407 × <i>g</i> 14000 rpm 8.4 cm
	Microtainers 0.6 mL/2 mL 1/30	 5425 716 001	Open Ø 8 mm	20817 × <i>g</i> 14000 rpm 9.5 cm

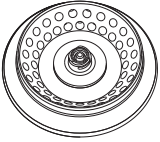

**14.5 Rotor FA-45-48-11 and rotor F-45-48-11**

Aerosol-tight fixed-angle rotor and fixed-angle rotor for 48 micro test tubes

Rotors FA-45-48-11 and F-45-48-11

	Max. <i>g</i> -force, outer row:	18213 × <i>g</i>
	Max. <i>g</i> -force, inner row:	16049 × <i>g</i>
	Max. speed:	12700 rpm
	Max. weight in the rotor (adapter, tube and contents):	48 × 3.75 g

Tube	Tube  Capacity Tubes per adapter/rotor	Adapter  Order no. (international)	Bottom shape  Diameter	Max. <i>g</i> -force, outer row Max. <i>g</i> -force, inner row Max. speed Outer row radius Inner row radius
	Micro test tube  1.5 mL/2.0 mL -/48	-	-  Ø 11 mm	18213 × <i>g</i> 16049 × <i>g</i> 12700 rpm 10.1 cm 8.9 cm
	PCR tube  0.2 mL 1/48	  5425 715 005	Conical  Ø 6 mm	14426 × <i>g</i> 12262 × <i>g</i> 12700 rpm 8 cm 6.8 cm
	Micro test tube  0.4 mL 1/48	  5425 717 008	Conical  Ø 6 mm	18213 × <i>g</i> 16049 × <i>g</i> 12700 rpm 10.1 cm 8.9 cm
	Micro test tube  0.5 mL 1/48	  5425 716 001	Open  Ø 8 mm	16229 × <i>g</i> 14065 × <i>g</i> 12700 rpm 9 cm 7.8 cm

Tube	Tube Capacity Tubes per adapter/rotor	Adapter Order no. (international)	Bottom shape Diameter	Max. g-force, outer row Max. g-force, inner row Max. speed Outer row radius Inner row radius
	Microtainers 0.6 mL 1/48	 5425 716 001	Open Ø 8 mm	18213 × <i>g</i> 16049 × <i>g</i> 12700 rpm 10.1 cm 8.9 cm

#### 14.6 Rotor F-45-48-5-PCR

Fixed-angle rotor for 48 PCR tubes.

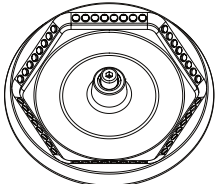
Rotor F-45-48-5-PCR		
	Max. g-force:	11710 × <i>g</i>
	Max. speed:	10500 rpm
	Max. weight in the rotor (adapter, tube and contents):	48 × 0.43 g

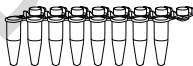
Tube	Tube Capacity Tubes per adapter/rotor	Adapter Order no. (international)	Bottom shape Diameter	Max. g-force Max. speed Radius
	0.2 mL -/48	-	Conical Ø 6 mm	11710 × <i>g</i> 10500 rpm 9.5 cm
	PCR strips 0.2 mL/2.0 mL -/6 × 8	-	Conical Ø 6 mm	11710 × <i>g</i> 10500 rpm 9.5 cm

#### 14.7 Rotor S-24-11-AT

This rotor is intended only for 1.5 mL/2.0 mL micro test tubes.



**Suitable rotors**  
Centrifuge 5427 R  
English (EN)

The following tubes must not be used in this rotor:

- Adapters for tubes 0.2 mL, 0.4 mL, 0.5 mL and 0.6 mL and the respective tubes.
- Centrifugation columns

**Rotor S-24-11-AT**

	Max. <i>g</i> -force:	16049 × <i>g</i>
	Max. speed:	12700 rpm
	Max. weight in the rotor (adapter, tube and contents):	4 × 3.75 g

Tube	Tube Capacity Tubes per adapter/rotor	Bucket	Bottom shape Diameter	Max. <i>g</i> -force Max. speed Radius
	Micro test tube 1.5 mL/2.0 mL -/24		- Ø 11 mm	16049 × <i>g</i> 12700 rpm 8.9 cm

DOMINIQUE DUTSCHER SAS

## 15 Ordering information

### 15.1 Rotors

#### Rotor FA-45-12-17

Description	Order no.
<b>Rotor FA-45-12-17</b> aerosol-tight, aluminum, angle 45°, 12 tubes, max. tube diameter 17 mm, incl. rotor lid (aluminum)	5409 700 006
<b>Rotor lid FA-45-12-17</b> aerosol-tight, aluminum	5409 701 002
<b>Seal for rotor lid</b> FA-45-12-17 (5427 R) Set of 5	5409 716 000

#### Rotor FA-45-24-11

Description	Order no.
<b>Rotor FA-45-24-11</b> aerosol-tight, aluminum, angle 45°, 24 tubes, max. tube diameter 11 mm, incl. rotor lid (aluminum)	5409 702 009
<b>Rotor lid FA-45-24-11</b> aerosol-tight, aluminum	5409 703 005
<b>Seal for rotor lid</b> FA-45-24-11 (5427 R), FA-45-16-17 (5430/5430 R) Set of 5	5409 717 006

#### Rotor FA-45-30-11

Description	Order no.
<b>Rotor FA-45-30-11</b> aerosol-tight, aluminum, angle 45°, 30 tubes, max. tube diameter 11 mm, incl. rotor lid (aluminum)	5409 706 004
<b>Rotor lid FA-45-30-11</b> aerosol-tight, aluminum	5409 707 000
<b>Seal for rotor lid</b> FA-45-30-11 (5427 R, 5430/5430 R) Set of 5	5820 762 004

**Ordering information**

Centrifuge 5427 R  
English (EN)

**Rotor F-45-30-11**

Description	Order no.
<b>Rotor F-45-30-11</b> aluminum, angle 45°, 30 tubes, max. tube diameter 11 mm, incl. rotor lid (polypropylene)	5409 708 007
<b>Rotor lid F-45-30-11</b> polypropylene	5409 709 003

**Rotor FA-45-48-11**

Description	Order no.
<b>Rotor FA-45-48-11</b> aerosol-tight, aluminum, angle 45°, 48 tubes, max. tube diameter 11 mm, incl. rotor lid (aluminum)	5409 710 001
<b>Rotor lid FA-45-48-11</b> aerosol-tight, aluminum	5409 711 008
<b>Seal for rotor lid</b> FA-45-48-11 (5427 R, 5430/5430 R, 5804/5804 R, 5810/5810 R), FA-45-24-11-Kit (5427 R, 5430/5430 R), FA-30x2 (5910 R, 5920 R, 5910 Ri), FA-48x2 (5910 R, 5920 R, 5910 Ri) Set of 5	5820 767 006

**Rotor FA-45-48-11-Kit**

Description	Order no.
<b>Rotor FA-45-48-11-Kit</b> aerosol-tight, aluminum, angle 45°, 24 tubes, max. tube diameter 11 mm, incl. rotor lid	5409 704 001
<b>Rotor lid FA-45-48-11-Kit</b> aerosol-tight, aluminum	5409 705 008
<b>Seal for rotor lid</b> FA-45-24-11-Kit (5427 R, 5430/5430 R), FA-45-48-11 (5427 R, 5430/5430 R, 5804/5804 R, 5810/5810 R), FA-30x2 (5910 R, 5920 R, 5910 Ri), FA-48x2 (5910 R, 5920 R, 5910 Ri) Set of 5	5820 767 006

**Rotor F-45-48-5-PCR**

Description	Order no.
<b>Rotor F-45-48-5-PCR</b> aluminum, angle 45°, 48 tubes, max. tube diameter 6 mm	5409 714 007

### Rotor S-24-11-AT

Description	Order no.
<b>Rotor S-24-11-AT</b> aerosol-tight, steel, angle 90°, 24 tubes, max. tube diameter 11 mm, incl. rotor lid (aluminum)	5409 715 003
<b>Rotor lid S-24-11-AT</b> aerosol-tight, aluminum	5409 720 007
<b>Seal for rotor lid</b> S-24-11-AT (5427 R, 5430/5430 R) Set of 5	5409 719 009
<b>Tube holder for S-24-11-AT</b> for 4 × 1.5/2.0-mL-tubes Set of 2	5409 721 003

### Adapter

Description	Order no.
<b>Adapter for mains/power cord</b> 230 V, Europe 0.25 m	0113 206 888
230 V, ARG 0.25 m	0113 206 896
230 V, GB/HK 0.25 m	0113 206 900
230 V, AUS 0.25 m	0113 206 918
230 V, CN 0.25 m	0113 206 926
120 V, US 0.25 m	0113 206 934
<b>Adapter</b> Use in FA-45-48-11, F-45-48-11, FA-45-30-11, F-45-30-11, FA-45-24-11, FA-45-24-11, FA-45-24-11 kit  for 1 PCR tube (0.2 mL, max. Ø 6 mm), set of 6 for 1 micro test tube (0.4 mL, max. Ø 6 mm), set of 6 for 1 micro test tube (0.5 mL, max. Ø 6 mm) or 1 Microtainer (0.6 mL, max. Ø 8 mm), set of 6	  5425 715 005 5425 717 008 5425 716 001

## 15.2 Accessories

### Auxiliary equipment

Description	Order no.
<b>Rotor key</b> Standard	5416 301 001
<b>Condensation water tray</b>	5409 850 083
<b>Pivot grease</b> Tube 20 mL	5810 350 050

DOMINIQUE DUTSCHER SPS

DOMINIQUE DUTSCHER SAS

**Appendix**

DOMINIQUE DUTSCHER SAS

# Declaration of Conformity

The product named below fulfills the requirements of directives and standards listed. In the case of unauthorized modifications to the product or an unintended use this declaration becomes invalid. This declaration of conformity is issued under the sole responsibility of the manufacturer.

**Product name:**

Centrifuge 5427 R

including components

**Product type:**

Centrifuge

**Relevant directives / standards:**

2006/42/EC: DIN EN ISO 12100 + Cor.1, DIN EN 378-2

2014/35/EU: DIN EN 61010-1, DIN EN 61010-2-011, DIN EN 61010-2-020

2014/30/EU: DIN EN 61326-1, DIN EN 55011

2011/65/EU: DIN EN IEC 63000  
(incl. (EU) 2015/863)

1907/2006/EC DIN EN 50419

94/62/EG DIN EN ISO 11469

**Further applied standards:**

IEC 61010-1 + Cor. + A1 + A1/Cor.1, IEC 61010-2-011, IEC 61010-2-020, UL 61010-1, UL 61010-2-011, UL 61010-2-020, CAN/CSA C22.2 No. 61010-1-12, CAN/CSA-C22.2 No. 61010-2-011, CAN/CSA C22.2 No. 61010-2-020, IEC 61326-1, CISPR 11 + A1, 47 CFR FCC part 15, GB 4793.1, GB 4793.7, GB 18268.1, SJ/T 11364, GB/T 26572, ASTM D4169, DIN EN ISO 780

**Person authorized to compile**

the technical file acc. to 2006/42/EC: Eppendorf SE  
Barkhausenweg 1  
22339 Hamburg  
Germany

Hamburg, January 10, 2023

  
Dr. Wilhelm Plüster  
Management Board  
Dr. Marlene Jentzsch  
Senior Vice President  
Division Separation & Instrumentation

Your local distributor: [www.eppendorf.com/contact](http://www.eppendorf.com/contact)  
Eppendorf SE · Barkhausenweg 1 · 22339 Hamburg · Germany  
[eppendorf@eppendorf.com](mailto:eppendorf@eppendorf.com)

Eppendorf® and the Eppendorf Brand Design are registered trademarks of Eppendorf SE, Germany. All rights reserved, incl. graphics and pictures. Copyright ©2022 by Eppendorf SE.

ISO 9001  
CertifiedISO 13485  
CertifiedISO 14001  
Certified

# Declaration of Conformity

The product named below fulfills the requirements of directives and standards listed. In the case of unauthorized modifications to the product or an unintended use this declaration becomes invalid. This declaration of conformity is issued under the sole responsibility of the manufacturer.

**Product Name:**

Centrifuge 5427 R

including components

**Product Type:**

Centrifuge

**Article Number:**

5429 000.XXX

**Relevant Directives / Standards:**

The Supply of Machinery (Safety) Regulations 2008 (2008 No. 1597)  
EN ISO 12100, EN 378-2

Electrical Equipment (Safety) Regulations 2016 (2016 No. 1101);  
EN 61010-1, EN 61010-2-020

Electromagnetic Compatibility Regulations 2016 (2016 No. 1091):  
EN 61326-1:2013

The Restriction of the Use of Certain Hazardous Substances in Electrical and Electronic Equipment  
Regulations 2012 (2012 No. 3032):  
EN IEC 63000

The Waste Electrical and Electronic Equipment Regulations 2013

The Packaging (Essential Requirements) Regulations 2015

The REACH etc. (Amendment etc.) (EU Exit) Regulations 2020

**Your local distributor: [www.eppendorf.com/contact](http://www.eppendorf.com/contact)**  
Eppendorf SE · Barkhausenweg 1 · 22339 Hamburg · Germany  
[eppendorf@eppendorf.com](mailto:eppendorf@eppendorf.com)

Eppendorf® and the Eppendorf Brand Design are registered trademarks of Eppendorf SE, Germany.  
U.S. Design Patents are listed on [www.eppendorf.com/ip](http://www.eppendorf.com/ip).  
All rights reserved, incl. graphics and images. Copyright ©2022 by Eppendorf SE.

[www.eppendorf.com](http://www.eppendorf.com)

ISO  
9001  
Certified

ISO 13485  
Certified

ISO 14001  
Certified

# Declaration of Conformity

The product named below fulfills the requirements of directives and standards listed. In the case of unauthorized modifications to the product or an unintended use this declaration becomes invalid. This declaration of conformity is issued under the sole responsibility of the manufacturer.

**Legal Manufacturer:**

Eppendorf SE  
Barkhausenweg 1  
22339 Hamburg  
Germany

**Person authorized to compile the Technical File:**

Eppendorf SE  
Barkhausenweg 1  
22339 Hamburg  
Germany

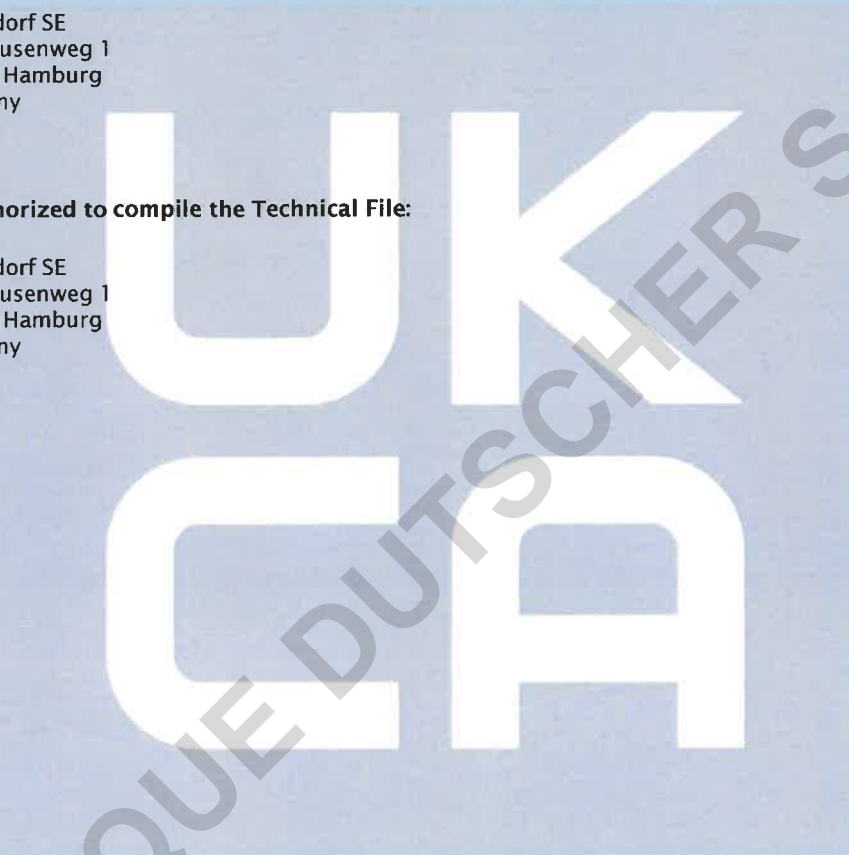

Hamburg, January 10, 2023

Dr. Wilhelm Plüster  
Management Board

Marlene Jentzsch  
Senior Vice President  
Division Separation & Instrumentation

**Your local distributor:** [www.eppendorf.com/contact](http://www.eppendorf.com/contact)  
Eppendorf SE · Barkhausenweg 1 · 22339 Hamburg · Germany  
[eppendorf@eppendorf.com](mailto:eppendorf@eppendorf.com)

Eppendorf® and the Eppendorf Brand Design are registered trademarks of Eppendorf SE, Germany.  
U.S. Design Patents are listed on [www.eppendorf.com/ip](http://www.eppendorf.com/ip).  
All rights reserved, incl. graphics and images. Copyright ©2022 by Eppendorf SE.

[www.eppendorf.com](http://www.eppendorf.com)





# Certificate of Containment Testing

## Containment Testing of Rotor FA-45-48-11 (5409 710.109-00) in the Eppendorf 5427/R Bench Top Centrifuge

Report No. 200-12 A

**Report Prepared For:** Eppendorf AG, Hamburg, Germany

**Issue Date:** 12<sup>th</sup> September 2012

### Test Summary

Rotor FA-45-48-11 (5409 710.109-00) was containment tested in the Eppendorf 5427/R bench top centrifuge, using Annex AA of IEC 1010-2-20. The sealed rotor was shown to contain a spill within the centrifuge

**Report Written By**

Handwritten signature of Anna Moy in black ink.

**Name: Miss Anna Moy**

**Title: Biosafety Scientist**

**Report Authorised By**

Handwritten signature of Sara Speight in black ink.

**Name: Mrs Sara Speight**

**Title: Senior Biosafety Scientist**



# Certificate of Containment Testing

## Containment Testing of Rotor FA-45-30-11 (5409 706.101-00) in the Eppendorf 5427/R Bench Top Centrifuge

Report No. 200-12 B

**Report Prepared For:** Eppendorf AG, Hamburg, Germany

**Issue Date:** 12<sup>th</sup> September 2012

### Test Summary

Rotor FA-45-30-11 (5409 706.101-00) was containment tested in the Eppendorf 5427/R bench top centrifuge, using Annex AA of IEC 1010-2-20. The sealed rotor was shown to contain a spill within the centrifuge

**Report Written By**

Handwritten signature of Anna Moy in black ink.

**Name:** Miss Anna Moy  
**Title:** Biosafety Scientist

**Report Authorised By**

Handwritten signature of Sara Speight in black ink.

**Name:** Mrs Sara Speight  
**Title:** Senior Biosafety Scientist



# Certificate of Containment Testing

## Containment Testing of Rotor FA-45-24-11 (5409 702.106-00) in the Eppendorf 5427/R Bench Top Centrifuge

Report No. 200-12 D

**Report Prepared For:** Eppendorf AG, Hamburg, Germany

**Issue Date:** 12<sup>th</sup> September 2012

### Test Summary

Rotor FA-45-24-11 (5409 702.10-00) was containment tested in the Eppendorf 5427/R bench top centrifuge, using Annex AA of IEC 1010-2-20. The sealed rotor was shown to contain a spill within the centrifuge

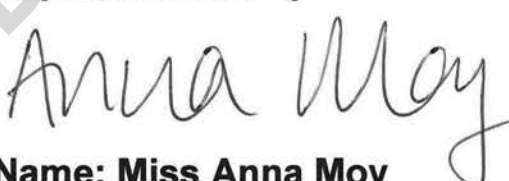
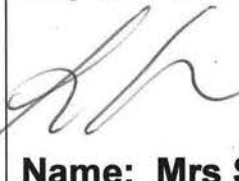
<b>Report Written By</b>  <b>Name: Miss Anna Moy</b> <b>Title: Biosafety Scientist</b>	<b>Report Authorised By</b>  <b>Name: Mrs Sara Speight</b> <b>Title: Senior Biosafety Scientist</b>
--	--



# Certificate of Containment Testing

## Containment Testing of Rotor FA-45-24-11-Kit (5409 704.109-00) in the Eppendorf 5427/R Bench Top Centrifuge

Report No. 200-12 E

**Report Prepared For:** Eppendorf AG, Hamburg, Germany

**Issue Date:** 12<sup>th</sup> September 2012

### Test Summary

Rotor FA-45-24-11-Kit (5409 704.109-00) was containment tested in the Eppendorf 5427/R bench top centrifuge, using Annex AA of IEC 1010-2-20. The sealed rotor was shown to contain a spill within the centrifuge

**Report Written By**

Handwritten signature of Anna Moy in cursive script.

**Name: Miss Anna Moy**

**Title: Biosafety Scientist**

**Report Authorised By**

Handwritten signature of Sara Speight in cursive script.

**Name: Mrs Sara Speight**

**Title: Senior Biosafety Scientist**



# Certificate of Containment Testing

## Containment Testing of Rotor FA-45-12-17 (5409 700.103-00) in the Eppendorf 5427/R Bench Top Centrifuge

Report No. 38/13

**Report Prepared For:** Eppendorf AG, Hamburg, Germany

**Issue Date:** 24<sup>th</sup> April 2013

### Test Summary

Rotor FA-45-12-17 (5409 700.103-00) was containment tested in the Eppendorf 5427/R bench top centrifuge, using Annex AA of IEC 61010-2-020:2006 (2<sup>nd</sup> Ed.). The sealed rotor was shown to contain a spill within the centrifuge.

**Report Written By**

**Name:** Miss Anna Moy

**Title:** Biosafety Scientist

**Report Authorised By**

**Name:** Mrs Sara Speight

**Title:** Senior Biosafety Scientist



# Certificate of Containment Testing

## Containment Testing of Rotor S-24-11-AT (5409 715.100-00) in the Eppendorf 5427/R Bench Top Centrifuge

Report No. 200-12 F

**Report Prepared For:** Eppendorf AG, Hamburg, Germany

**Issue Date:** 12<sup>th</sup> September 2012

### Test Summary

Rotor S-24-11-AT (5409 715.100-00) was containment tested in the Eppendorf 5427/R bench top centrifuge, using Annex AA of IEC 1010-2-20. The sealed rotor was shown to contain a spill within the centrifuge

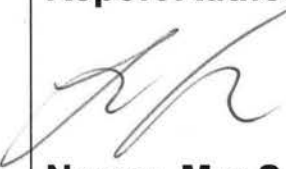
<b>Report Written By</b>  <b>Name: Miss Anna Moy</b> <b>Title: Biosafety Scientist</b>	<b>Report Authorised By</b>  <b>Name: Mrs Sara Speight</b> <b>Title: Senior Biosafety Scientist</b>
--	--

DOMINIQUE DUTSCHER SAS

DOMINIQUE DUTSCHER SAS

# Evaluate Your Manual

Give us your feedback.

[www.eppendorf.com/manualfeedback](http://www.eppendorf.com/manualfeedback)

DOMINIQUE DUTSCHER SAS

**Your local distributor: [www.eppendorf.com/contact](http://www.eppendorf.com/contact)**

Eppendorf SE · Barkhausenweg 1 · 22339 Hamburg · Germany  
[eppendorf@eppendorf.com](mailto:eppendorf@eppendorf.com) · [www.eppendorf.com](http://www.eppendorf.com)