



Universal Oven Um UN110m

The heating oven Um is a Class I medical device in accordance with the EU directive 93/42/EEC.



This universal oven made of high-quality hygienic, easy to clean stainless steel leaves nothing to be desired in terms of ventilation technology, control technology, overtemperature protection and perfectly tuned heating technology.

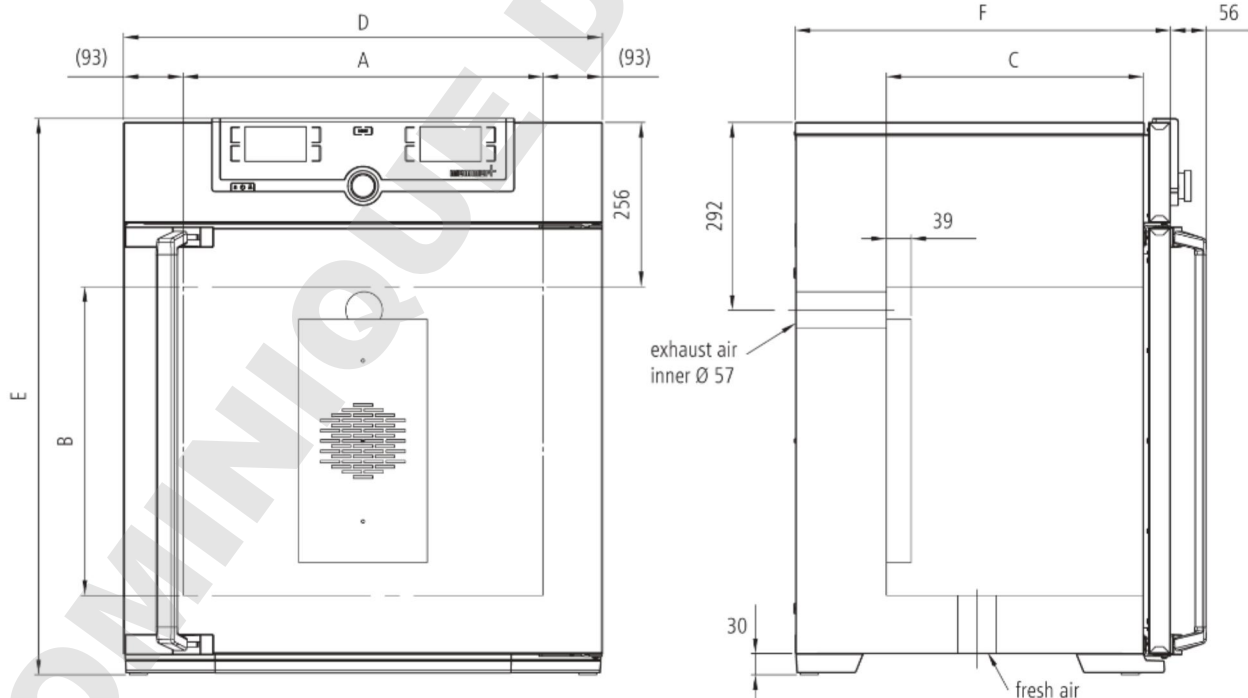

Temperature

Set temperature range in °C	min. 5°C above ambient up to +300°C
Temperature	1 Pt100 sensor DIN class A in 4-wire-circuit

Control technology

Language setting	German, English, Spanish, French, Polish, Czech, Hungarian
ControlCOCKPIT	SingleDISPLAY. Adaptive multifunctional digital PID-microprocessor controller with high-definition TFT-colour display
Timer	Digital backwards counter with target time setting, adjustable from 1 minute to 99 days
Function SetpointWAIT	the process time does not start until the set temperature is reached
Calibration	three freely selectable temperature values
adjustable parameters	temperature (Celsius or Fahrenheit), air flap position, programme time, time zones, summertime/wintertime

Ventilation

Convection	natural convection
Fresh air admixture	adjustment of pre-heated fresh air admixture by air flap control in 10 % steps
Vent	vent connection with restrictor flap

Communication

Documentation	programme stored in case of power failure
Programming	AtmoCONTROL software for reading out, managing and organising the data logger via Ethernet interface (temporary trial version can be downloaded). USB stick with AtmoCONTROL software available as accessory (on demand).

Safety

Temperature control	adjustable electronic overtemperature monitor and mechanical temperature limiter TB, protection class 1 according to DIN 12880 to switch off the heating approx. 20°C above nominal temperature
Autodiagnostic system	for fault analysis

Standard equipment

Internals	2 stainless steel grid(s), electropolished
Works calibration certificate	Calibration at +160°C
Door	fully insulated stainless steel door with 2-point locking (compression door lock)

Stainless steel interior

Interior	easy-to-clean interior, made of stainless steel, reinforced by deep drawn ribbing with integrated and protected large-area heating on four sides
Volume	0 l
Dimensions W x H x D in mm	$w_{(A)} \times h_{(B)} \times d_{(C)}$: 560 x 480 x 400 mm
Max. number of internals	5
Max. loading of chamber	175 kg
Max. loading per internal	20 kg

Textured stainless steel casing

Dimensions	$w_{(D)} \times h_{(E)} \times d_{(F)}$: 745 x 864 x 584 mm
Housing	rear zinc-plated steel

Electrical data

Voltage	230 V, 50/60 Hz
Electrical load	approx. 2800 W
Voltage	115 V, 50/60 Hz
Electrical load	approx. 1800 W

Packing/shipping data/Setting Up

Set Up	The distance between the wall and the rear of the appliance must be at least 15 cm. The clearance from the ceiling must not be less than 20 cm and the side clearance from walls or nearby appliances must not be less than 5 cm.
Transport information	The appliances must be transported upright
Customs tariff number	8419 8998
Country of origin	Federal Republic of Germany
WEEE-Reg.-No.	DE 66812464
Dimensions approx incl. carton	B x H x T: 830 x 1050 x 800 mm
Net weight	approx. 74 kg
Gross weight carton	approx. 99 kg

Standard units are safety-approved and bear the test marks

