

GeneExplorer Thermal Cycler

Instruction for Use

REF GE-96G, GE-384G, GE-4I, GE-48D, GE-48DS, GE-48DG, GE-96S



Hangzhou Bioer Technology Co., Ltd.

Note: Please understand that no further notice will be given for any

modification to the information contained herein.

The document contains patent information under copyright protection. All rights reserved. Without prior written approval from Hangzhou Bioer Technology Co., Ltd., any part of the document shall not be copied, re-produced or translated into other language.

***Before using the instrument for the first time,
please carefully read the Operation Manual !***

File No.: BYQ56170000000ESM

File Version: Nov. 2021 Edition 2.0

Important Notes

Convention

Attention:	Information of extreme importance is contained under the item of Attention, thus please carefully read it. Failure to practice as per the instruction may lead to equipment damage or operation failure.
Warning!	Information under the item of Warning requires special attention for specific operation step or method. Failure to practice as per the requirements may lead to severe personal injury.

1 Safety

The following basic safety measures must be abided by through all stages including equipment operation, maintenance and repair. Failure to abide by these measures or warnings indicated in the manual may affect the protection provided by the instrument. Meanwhile, it may damage the safety standard for design and manufacturing, and expected application scope of the instrument. *Hangzhou Bioer Technology Co., Ltd. takes no responsibility for any consequences arising from user's failure for abiding by the following requirements.*

Attention: The instrument is Type-I equipment in line with GB4793.1 standard with protection level of IP20. The instrument is designed for indoor use.

A) Instrument grounding

To prevent electric shock, the input power line of the instrument must be reliably grounded. The instrument adopts three-core grounding plug which includes a third (grounding) foot and can only be used together with grounding socket. This is a safety device. If the plug cannot be inserted into socket, please ask an electrician to install correct socket, and don't let the grounding socket lose its function of safety.

B) Keep away from energized circuit

Operator should not arbitrarily dismantle the instrument. Component replacement or in-machine adjustment must be completed by specialized maintenance personnel with certificate. Don't replace any component when the power line is connected.

C) Attention for power supply

Before connecting AC power supply, ensure the consistency of the voltage of the power supply and the voltage required by the instrument (a deviation of $\pm 10\%$ is allowed), and ensure the

rated loading of the power socket is no less than the requirement of the instrument.

D) Attention for power line

Generally, the instrument should use the power line supplied along with the instrument. In case of power line damage, it must be replaced instead of repair. For replacement, power line of same type and specification should be used. Don't put anything on the power line when the instrument is being used. Don't place the power line in the place where people walk through. If the power line will contact thermal surface when it is used, then protection measures should be taken to prevent insulation damage to the power line.

E) Plug in and plug off

The plug must be held in hand for plugging in and plugging off. For plugging in, ensure that the plug is completely inserted into the socket, and don't pull the power line forcibly for plugging off.

F) Attention for instrument placing

The instrument should be placed in area of low humidity, less dust and far away from water source (such as close to water pool or water pipe), and the place should be well ventilated and free from corrosive gas or high magnetic field interruption. Don't place the instrument in moisty or dusty area. Also, don't place the instrument in area making it difficult to operate the disconnecting device.

Openings on the instrument are designed for ventilation. To avoid overheating, don't block or cover the ventilating openings. For single machine operation, the ventilating openings on the instrument should be kept at least 20cm away from nearest objects. For simultaneous multiple machine operation, the distance between instruments should be no less than 10cm. additionally, don't use the instrument on floppy surface; otherwise the ventilating openings at instrument bottom may be blocked.

Over-temperature will affect the instrument performance or lead to faulty. Don't use the instrument under direct sunlight and keep the instrument away from heater, furnace and other heat source.

When the instrument is not in use for an extended period, unplug the power supply and cover the instrument with soft cloth or plastic paper to prevent dust entering in the machine.

Warning: The equipment should not be installed on the surface of inflammable materials!

G) Attention for operation

During experiment operation, avoid liquid dripping on the instrument.

When dealing with reagent, wear personal protective equipment such as protective gloves.

Attention: In any of the following cases, immediately unplug the power supply from the socket, and contact the supplier or ask qualified maintenance personnel for treatment:

- Liquid enters into the instrument.
 - The instrument is exposed to rain or wet by water.
 - The instrument fails to work normally, especially there is any abnormal sound or flavor.
 - The instrument drops down or the shell is damaged.
 - The instrument function has evident change.
 - For any doubt concerning the compatibility between detergent and equipment part or materials contained in the equipment, please consult the manufacturer or its agent.
-

H) Re-transport

If the instrument needs to be transported again, the detection hole position and the instrument should be thoroughly cleaned and sterilized with ultraviolet light before transportation.

I) Equipment Safety





The instrument was designed, produced, and tested in accordance with EN 61010-1 (IEC 61010-1) “Safety requirements for electrical equipment for measurement, control, and laboratory use -- Part 1: General requirements”. It has left the factory in a perfectly safe condition.

The instrument meets the requirements of the Regulation (EU) 2017/746 of the European Parliament and of the Council of 5 April 2017 on in vitro diagnostic medical devices.

2 Instrument label

A) Warning Sign

- Warning identification









DANGER!		Area with the mark pasted on the instrument shall avoid improper use and be careful of danger.
SCALDING!		Area with the mark pasted on the instrument causes high temperature and is scalding during use.
BIOHAZARD		Area with the mark pasted on the instrument will caused biohazard during use.
PROTECT CONDUCTOR TERMINAL		PROTECT CONDUCTOR TERMINAL is near to the area with the mark pasted on the instrument







- Warning mark



Warning! The instrument is pasted with a label of “HOT SURFACE!”. Any part of body is strictly prohibited from touching the metal part (module and hot lid) around the label during instrument operation or within a certain period after the program ends.

B) Other symbols on the packaging

Date of manufacture		Indicates the date when the medical device was manufactured.
RoHS		Restriction on the use of certain hazardous materials(restriction of hazardous substances)
Consult instructions for use		Indicates the need for the user to consult the instructions for use.
Serial number		Indicates the manufacturer’s derail number so that a specific medical device can be identified.
Catalogue number		Indicates the manufacturer’s catalogue number so that the medical device can be identified.
In vitro diagnostic medical device		Indicates a medical device that is intended to be used as an <i>in vitro diagnostic medical device</i> .
CE mark		Indicates the medical device meets the CE related Directives.
Manufacturer		Indicates the medical device manufacturer.

Authorised representative in the European Community		Indicates the authorized representative in the European Community.
Up		Indicates that the correct position of the transport package is vertical upward.
Fragile		The transport packages contain fragile goods, so they should be handled with care.
Keep dry		The package should be rain-proof.
The limit of stacking layer		Maximum stacking layer of the same package is 2.
Temperature limit		Indicates that the temperature limit of transportation package should be - 20 °C to 55 °C.

3 Instrument calibration

Before the instrument is delivered, the device is fully calibrated according to the Bioer 's factory inspection standard, all the actions are under the requirements of ISO 13485 Medical devices - Quality management systems Requirements for regulatory purposes. If the instrument is installed in the required working environment, there is no need to calibrate or correct the temperature after installation.

4 Instrument maintenance

Periodically use clean, soft cloth dipped with ethanol to clean the block wells on module to ensure sufficient contact between test tubes and taper holes and to ensure favorable heat conduction. If there is any dirt on the instrument surface, use soft cloth dipped with cleansing cream to clean.

Warning! The power must be cut off when cleaning the instrument surface.

Corrosive detergent is strictly prohibited from being used to clean the instrument surface.

The instrument module includes precise optics, dust, foreign matter and residue should be avoided.

5 Disposal



Potentially infectious material and all parts that may come in contact with potentially infectious material must be disposed in accordance with the relevant legal provisions.

All parts which have been replaced must be disposed in accordance with the relevant legal provisions.

 Disposal of the instrument must be carried out in accordance with the relevant legal provisions.

Disposal of the packaging material must be carried out in accordance with the relevant legal provisions.

6 After-sales service

See the Warranty Card for specific content and scope of warranty.

Attention: After opening the packaging box, immediately check the objects contained therein based on the packing list. In case of any object damage or missing, please immediately contact the supplier.

After acceptance inspection, fill out the Acceptance Inspection Form and send the copy (or fax) back to the company for filing and warranty service.

After the packaging box is opened, please properly keep the packaging box and packing materials which will be used during maintenance. Hangzhou Bioer Technology Co., Ltd. will take no responsibility for instrument damage caused by improper packaging during transport to the maintenance department.

Contents

CHAPTER ONE INTRODUCTION	3
1 INTRODUCTION TO PCR TECHNOLOGY	3
2 EXAMPLES OF PCR'S APPLICATIONS	3
3 FEATURES OF GENEEXPLORER THERMAL CYCLER	3
4 USE OF GENEEXPLORER THERMAL CYCLER	4
5 SERVICE LIFE OF THERMAL CYCLER	5
CHAPTER TWO CHARACTERISTICS	6
1 NORMAL OPERATION CONDITIONS	6
2 TRANSPORT AND STORAGE CONDITION	6
3 BASIC PARAMETERS	6
4 SOFTWARE FUNCTIONS	7
5 SOFTWARE VERSION	7
CHAPTER THREE PREPARATIONS	8
1 STRUCTURAL SCHEMATIC DIAGRAM	8
2 CHECK BEFORE TURNING ON THE INSTRUMENT	9
3 TURN ON THE INSTRUMENT	9
CHAPTER FOUR OPERATION INSTRUCTIONS	10
1 TURN ON THE INSTRUMENT	10
2 PCR PROGRAM EDITING	12
2.1 SETTING OF PROGRAM SECTION	13
2.2 SECTION TEMPERATURE AND CONSTANT TEMPERATURE TIME	13
2.3 FUNCTION OF LOOP	14
2.4 EXTENDED PARAMETER	15
2.5 SAVE EXPERIMENT	16
3 RUN PROGRAM	16
3.1 TEMPERATURE CONTROL MODE	17
4 FILE MANAGEMENT	18
5 SYSTEM SETTINGS	20
5.1 PERSONAL CENTER	21
5.2 SYSTEM SETTINGS	21
6 SOFTWARE UPGRADE	21
6.1 UI PROGRAM UPGRADE	21
6.2 DRIVER UPGRADE	22
CHAPTER FIVE FAULT ANALYSIS AND TROUBLESHOOTING	23
1 FAULT ANALYSIS AND TROUBLESHOOTING	23
APPENDIX 1 WIRING DIAGRAM (THE DIAGRAM IS ONLY FOR REFERENCE, AND PLEASE UNDERSTAND THAT NO	

FURTHER NOTICE WILL BE GIVEN FOR ANY MODIFICATION).....25

APPENDIX 2 VALUE AND MEANING OF SET PARAMETERS.....26

APPENDIX 3 PRODUCT EMC STATEMENT28

APPENDIX 4 LIST OF ACCESSORIES.....30

DOMINIQUE DUTSCHER SAS

Chapter One Introduction

The chapter covers introduction to PCR technology and examples of its applications, introduction to PCR Thermal Cycler and features of GeneExplorer Thermal Cycler.

1 Introduction to PCR technology

Polymerase Chain Reaction (PCR in short) is a nucleic acid amplification technology of in-vitro simulation of natural DNA reproduction process. With two DNA chains to be amplified as a template and mediated by a pair of artificially synthetic ODN primers, and through DNA polymerase of high temperature resistance, it can rapidly and specifically amplify specific DNA segment. Due to its simplicity, rapidity, peculiarity and sensitivity, ever since invention of PCR by Mullis in 1985 and discovery of DNA polymerase of high temperature resistance by Erlich in 1988, over a few years, the technology has been widely applied in various fields of bioscience. Especially in cytology, virology, oncology, genetic epidemiology, forensic pathology and flora and fauna immunology, it has accomplished outstanding achievements and become a milestone of contemporary molecular biology development.

2 Examples of PCR's applications

Application of Thermal Cycler: The product is applicable to polymerase chain reaction in fields including immunology, human genome engineering, forensic pathology, oncology, organization and population biology, paleontology, zoology and botany.

3 Intended use

The GeneExplorer Thermal Cycler is an automated instrument used for qualitative amplify the related nucleic acids in human sample using the polymerase chain reaction process. The instrument is for in vitro diagnostic only.

The GeneExplorer Thermal Cycler is intended for used in medical and biological laboratories by professional user trained in molecular biological techniques and the operation of GeneExplorer Thermal Cycler.

4 Features of GeneExplorer Thermal Cycler

GeneExplorer Thermal Cycler is a PCR of multiple functions and applications. It features as below:

- Providing up to eight replaceable modules based on requirements of various PCR experiments.

- Adopting advanced American ITI thermoelectric refrigeration technology and thermoelectric refrigeration element manufactured under Japanese quality management mode which presents stable and reliable performance;
- Maximum ramp rate up to 4°C/s and can be adjusted based on experiment requirements.
- Multiple temperature control modes and higher reagent compatibility.
- Host machine of GeneExplorer Thermal Cycler can automatically recognize module and run corresponding program.
- Colorful large-screen display, humanized operation interface, simple and clear operation.
- Power-off protection function, and after power supply recovery, it can continue to complete the program unfinished.
- Hot lid can adjust height and pressure based on actual using condition to adapt to different reaction tubes and effectively prevent reagent evaporation and pollution.
- USB standard port can be connected to general computers, convenient for software upgrade.

5 Use of GeneExplorer Thermal Cycler

GeneExplorer Thermal Cycler, taking a leading position among similar products, has combined various advanced technologies and can meet requirements of various PCR experiments.

Different modules have the suitable consumables, there are as follows.



Standard 0.2ml centrifuge tube



PCR Microplate



Glass slide

GE-96G / GE-96S:

- (1) 1×96×0.2ml
0.2ml standard centrifuge tube
- (2) 12×8×0.02ml
PCR 8-Strip Tube
- (3) 96×1×0.2ml (96 wells PCR Microplate)

GE-48D: GE-48DG: GE-48DS:

- (1) 48×0.2ml+48×0.2ml (48 wells PCR Microplate)

GE-384G: 384×0.02ml (384 wells PCR Microplate)

GE-4I: 4 pcs.of glass slide

6 Service life of Thermal Cycler

Service life of Thermal Cycler is 5 years from the date of instrument installation.

DOMINIQUE DUTSCHER SAS

Chapter Two Characteristics

The chapter mainly introduces the operation, transport and storage conditions of the instrument, and its basic parameters, performance and functions.

1 Normal operation conditions

Ambient temperature: 10°C ~ 30°C

RH: ≤70%

Power supply: 220V ~ 50Hz

Altitude: <2km

Attention: Before using the instrument, please confirm if the working conditions can meet the above requirements. Pay special attention to reliable grounding of the power line.

2 Transport and storage condition

Ambient temperature: -20°C ~ +55°C

RH: ≤80%

3 Basic parameters

The parameters of the modules are as below:

Name	Gene Explorer Thermal Cycler						
Model	GE-96G	GE-384G	GE-48D	GE-4I	GE-48DG	GE-48DS	GE-96S
Sample size	96×0.2ml	384×0.02ml	48×0.2ml+4 8×0.2ml	44×glass slide	48×0.2ml+4 8×0.2ml	48×0.2ml+4 8×0.2ml	96×0.2ml
gradient temperature range	30°C~99°C		/		30°C~99°C		/
gradient temperature difference range	1°C~30°C		/		1°C~30°C		/
Ladder Temperature range	/					0.1°C~6°C	
Energy consumption	600W				1200W		
Fuse	250V 12A 5 20						
LCD display	Color touch screen (8 inch, 260,000 colors)						

Temperature range	4.0-105°C(min. resolution: 0.1°C)
File saving amount	≥2000 standard programs
Operation mode	Continuous operation
Dimensions	420mm×269mm×254mm(L×W×H)
Net weight	13kg

Attention: When the set value of hot lid temperature is lower than the set value of module temperature, the hot lid temperature displayed on the screen will be higher than the set value of hot lid temperature.

4 Software functions

(1) file edit (including file number, temperature and time of each section, setting of loop times, view, revise and delete file, automatic file connection, gradient temperature setting; maximum number of editable sections is 10, maximum number of steps is 100, maximum number of loop is 99, available for secondary nesting, gradient temperature range is 1°C~30°C; Ladder Temperature range 0.1°C~6°C,

(2) file storage.

(3) file modification (including adjustment of ramp rate, automatic temperature & time modification during cycling, time display and calibration).

(4) setting of temperature, time and loop times during file running, and display of instant values (including voice prompt, estimation of overall and remaining time of file running, fault protection and warning);

(5) stop file running (including pause file running, stop file running and automatic recovery after outage).

Attention: The above software functions are only for reference. Please understand that no further notice will be given for any modification to the software functions.

5 Software version

Software version: V1.0

Chapter Three Preparations

The chapter mainly introduces the instrument structure, operation of touch screen, and preparations before turning on the instrument. If the instrument is used for the first time, please be familiar with the contents in the chapter before turning on the machine.

1 Structural schematic diagram

The structural parts of the instrument include heating module, hot lid, power switch module (including power switch, power socket, and fuse holder), and micro-computer controller and touch screen. All the modules of the instruments are the same except the heating modules,

Diagram for GE-96G, GE-96S, GE-384G

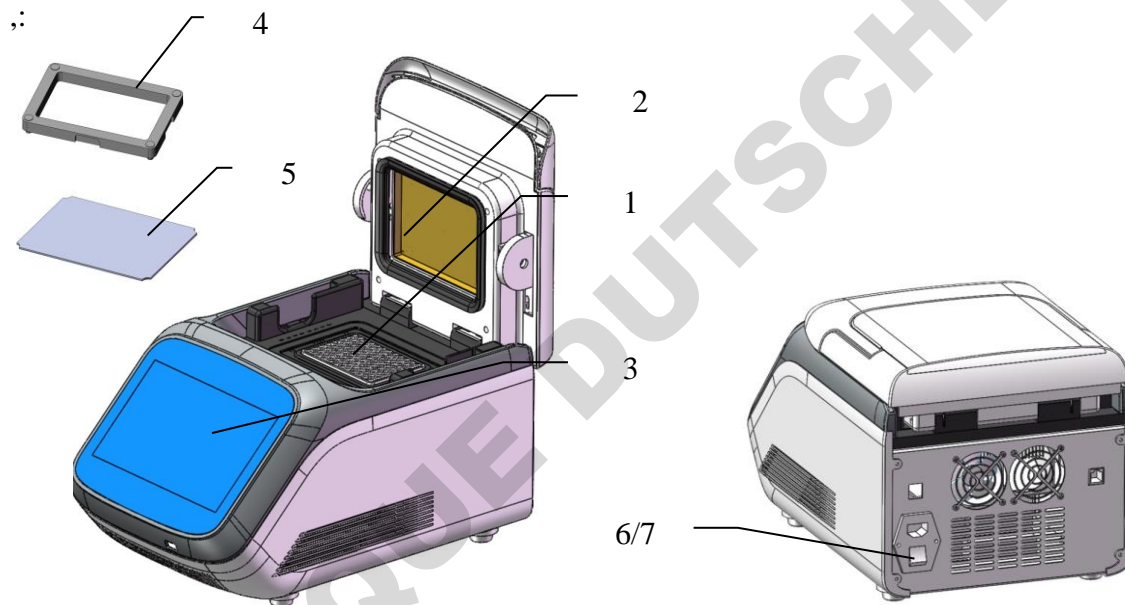

Heating Module for GE-48DS,

Heating Module for GE-48D,GE-48DG

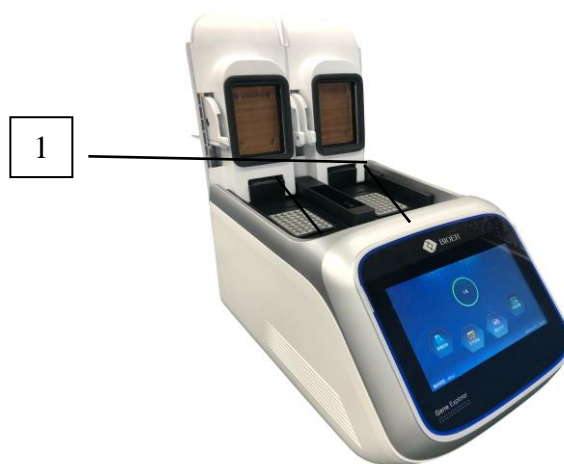

Attention: 1、 Requirements for fuse: 250V 12A $\varnothing 5 \times 20$. For fuse replacement, ① module ② hot lid ③ LCD screen ④ pressure balancing ⑤ compression pad. The power socket line with the power switch should be used. Contact the supplier or manufacturer if you need fuse.

2、 compression pad for 96 wells PCR plate and 384 wells PCR.

3、 pressure balancing plate for 0.2ml single tubes and 8-strip tubes

Usage of compression pad

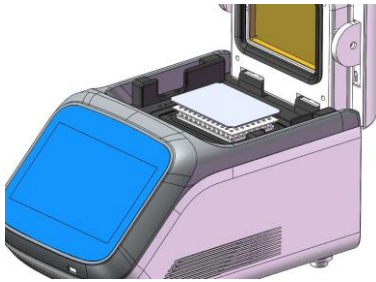

Usage of pressure balancing plate

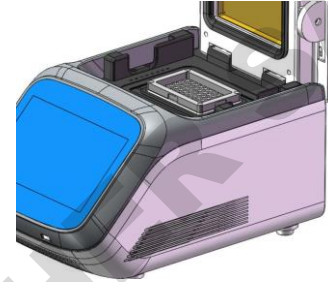

2. Check before turning on the instrument

Before plug in and energize the instrument, please confirm the following:

- 1 Confirm the power supply meets the voltage required by the instrument; (see Chapter Two for power supply requirements)
- 2 Confirm that the power supply plug has been reliably inserted into the power socket;
- 3 The power line is reliably grounded.

3 Turn on the instrument

Turn on the power switch (switch to the position of “-”), and then the instrument will carry out self-test which will take about 20s, please wait patiently. If the self-test has discovered no problems, the main interface will show on the screen, and you can edit, view, revise or delete PCR amplification files.

Chapter Four Operation Instructions

In this chapter, the methods of editing, viewing, revising, and deleting PCR amplification files are introduced in detail, as well as the method of running PCR amplification files and setting of instrument system parameters.

Warning! After the instrument is turned on, if there is any abnormal sound or display, or fault alarm and prompt present during instrument self-test, please immediately turn off the power and contact the supplier.

Attention: If the sample volume of your experiment is less than the number of cone holes of the module, please evenly distribute the test tubes to ensure stable press of the hot lid on the test tube tops, which will also contribute to uniform module loading and ensure uniformity of temperature change in each test tube.

1 Turn on the instrument

Turn on the power switch and then the instrument will carry out self-test, please wait patiently. If the self-test has discovered no problems, the main interface will show on the screen. Module Type is displayed at bottom left of the main interface. At the middle of the main interface, it displays four functions of software which are New Experiment, Open Experiment, Recently Opened and Settings.

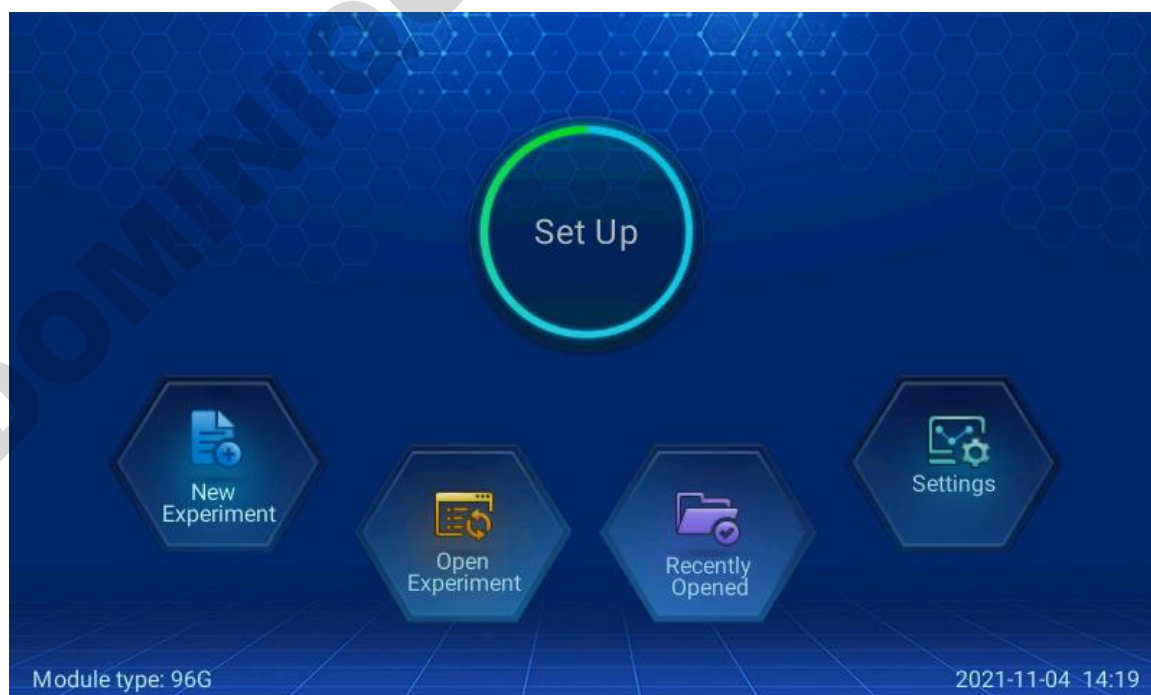



Picture for GE-96G



Picture for GE-48DS

Picture of Model GE-384G/GE-4I/GE-96S would show the module type with 384G, plate and 96V respectively.

- ✧ Press the icon “**New Experiment**” to enter into the interface of experiment parameter setting.

- ✧ Press the icon “**Open Experiment**” to enter into the interface of file list.
- ✧ Press the icon “**Recently Opened**” to view experiment.
- ✧ Press the icon “**Settings**” to enter Personal Center and System Settings.

During operation, instrument operation status is displayed on the main interface, and click to enter the interface of operation monitoring.

When operation is stopped, click to enter the interface of experiment parameter setting.

2 PCR program editing

Click “**New File**” on the main interface or click “**New Experiment**” under “**Open Experiment**” or “**Recently Opened**” to enter into the interface of program setting.

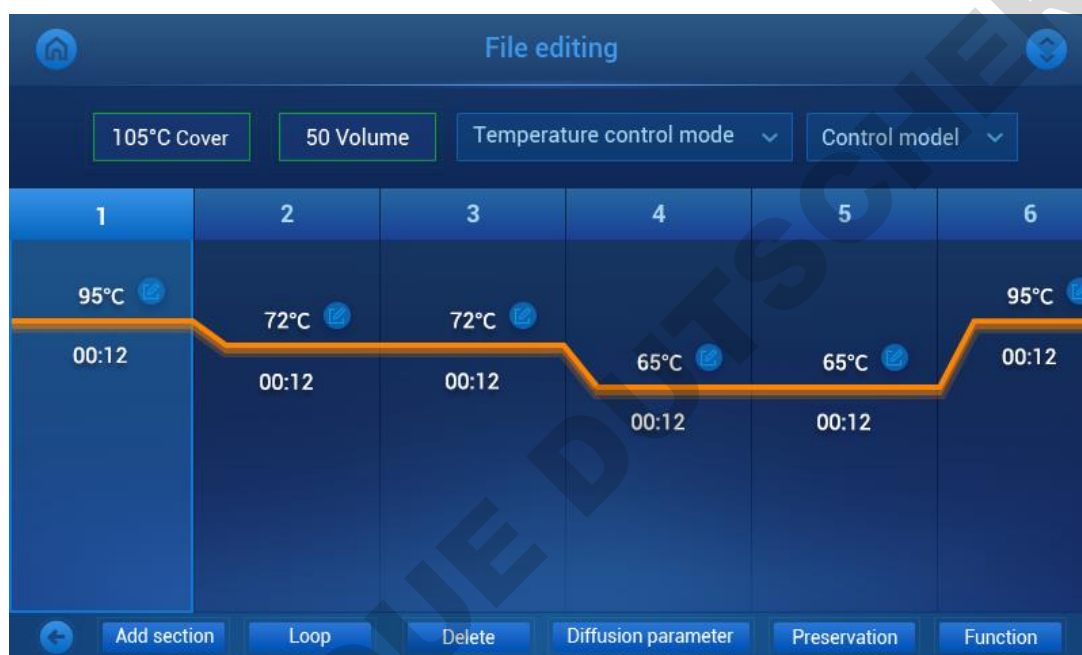

Picture for “**Open Experiment**” or “**Recently Opened**” selection



Picture for “New Experiment” selection

2.1 Setting of program section

Select one section of the program and the section will light up; click “**Section**”, then there will prompt the checkbox of “Insert” and “Add”. Click “Insert”, a new section will be added before the section selected and lighting up. Click “Add”, a section will be added to the end of the program.

Click “**Delete**” to delete the section selected.

2.2 Section temperature and constant temperature time

On the interface of PCR program setting, click the small icon on upper right of the screen, and it will prompt the temperature and time setting box for setting temperature and constant temperature time of the program section.

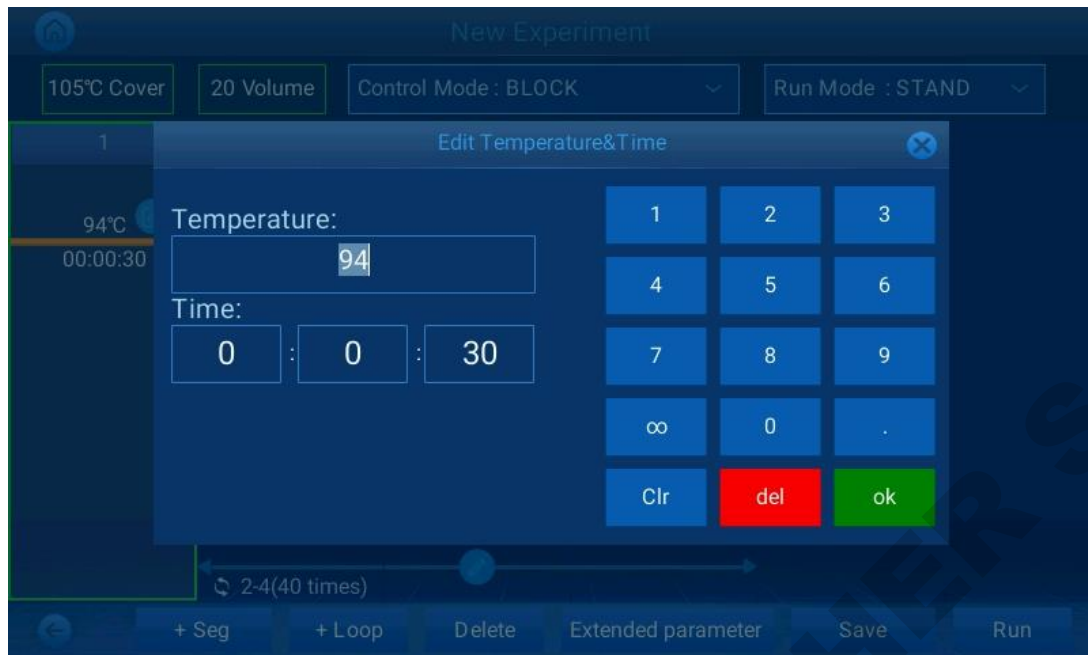

Run mode: Standard Mode and High-speed Mode.

Standard Mode running characteristics simulate BIOER TOUCH series.

2.3 Function of loop

On the interface of PCR program setting, click “**Loop**”, and it will prompt interface 1-1, select the starting and ending sections of the loop, click “**Determine**” and it will prompt the setting box 1-2 for loop times, input the times and click “**OK**”, the setting of loop section will be finished.

Attention: In one program, multiple loop sections can be set, but these sections cannot be crossed, but only paralleled or included.



Interface 1-1

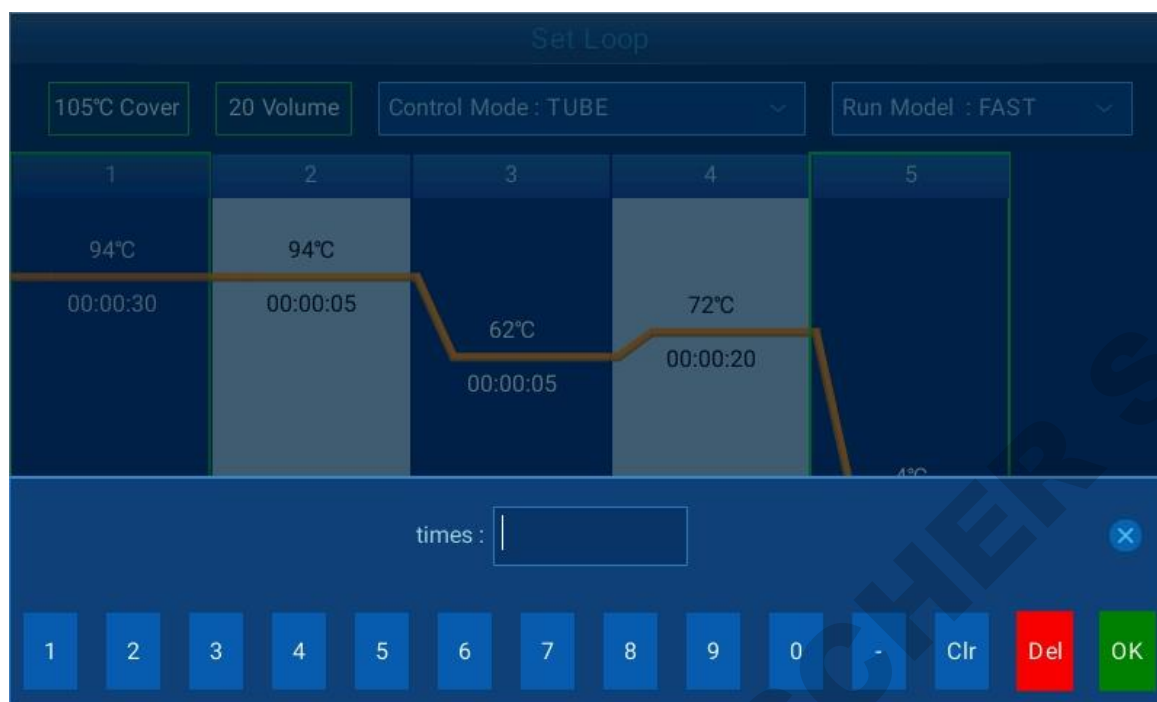

Interface 1-2

2.4 Extended parameter

On the interface of PCR program setting, click “**Extended parameter**” and it will prompt a box for setting extended temperature, extended time, speed, and gradient and other operations.

Extended temperature: the volume of temperature increase or decrease for each loop. “-/+” changes the positive and negative of data.

Extended time: time increase for each loop.

Speed: ramp rate

Gradient: gradients temperature refers to the temperature difference between the most left and most right ranks of the module. In “Temperature”, the temperature of the most left rank is set. GE-48DG, GE-96G, GE-384G own this function.

Ladder Temp: It refers to the temperature difference between two adjacent modules. The range is 0.1°C~6°C. “Temperature” is set to the temperature of the leftmost module. GE-48DS, GE-96S own this function.





2.5 Save experiment

On the interface of PCR program setting, click “Save”, and input username and file name to save the file. Files saved can be found under “Open Experiment”.

3 Run program

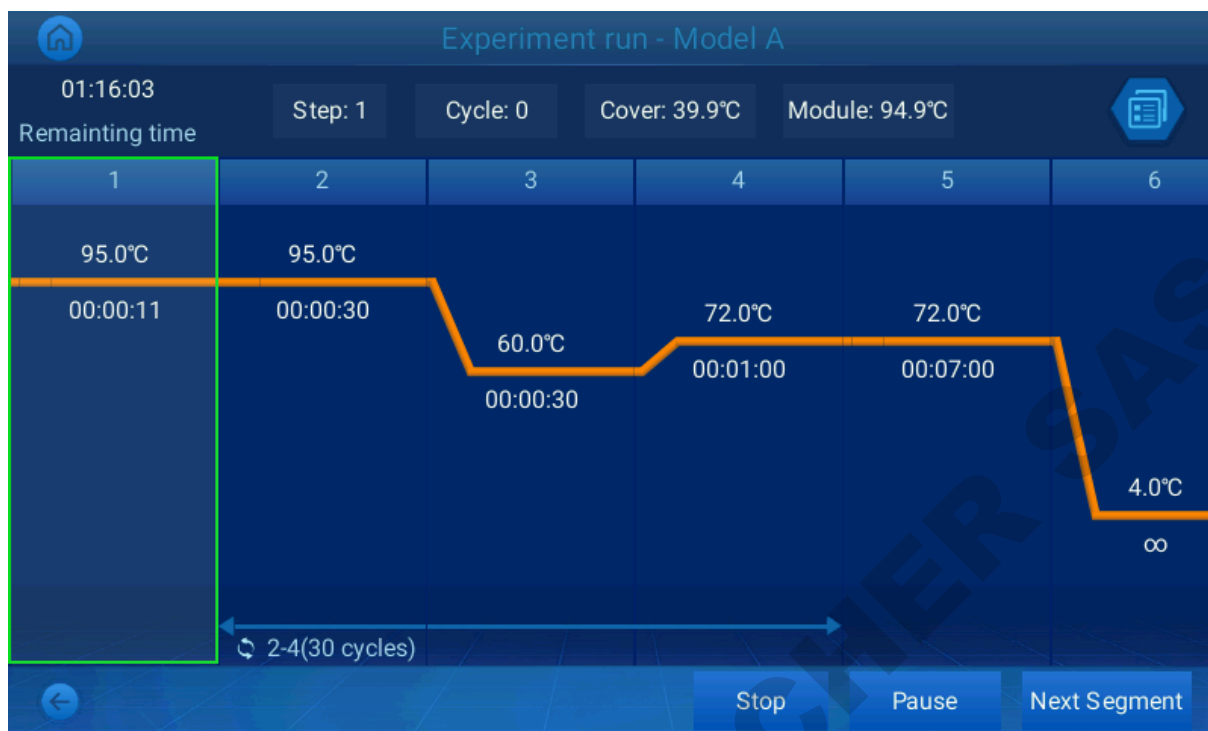
Before running experiment, set up hot lid temperature, reaction volume, temperature control mode and control mode on the interface of PCR program setting and then click “**Run**” to start the experiment. You can also run experiment by directly selecting the file under “**Open Experiment**” and “**Recently Opened**”.



Click  it will display the temperature of each module.



3.1 Temperature control mode

“Control Mode” represents the default temperature control mode after the system is turn on, and it includes two modes of “Block” and “Tube”.

“Block” mode only considers the temperature control of module during temperature ramp. As

the temperature ramp of reagent is lagging that of module, the actual temperature change of reagent is inconsistent with our settings that the actual time of reagent reaching set temperature is shorter than the set time (see the figure below for the relation between module temperature and reagent temperature).

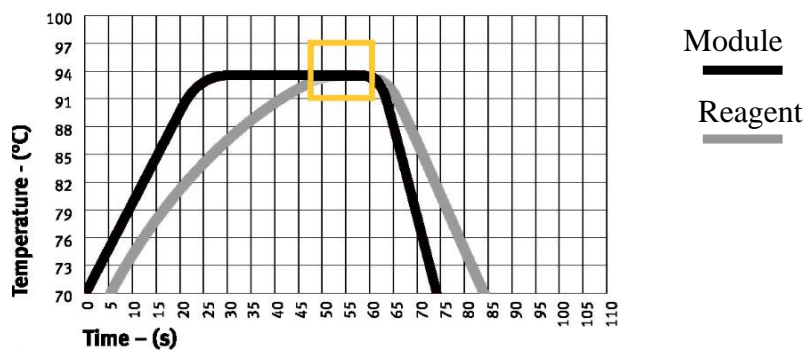

“Tube” mode considers the lagging reagent temperature ramp and provides an overshoot process after reaching set temperature to enable reagent to reach the set temperature more quickly. If setting time equal to that of “Block” mode, the actual time for reagent reaching set temperature is obviously extended (see the figure below for the relation between module temperature and reagent temperature).

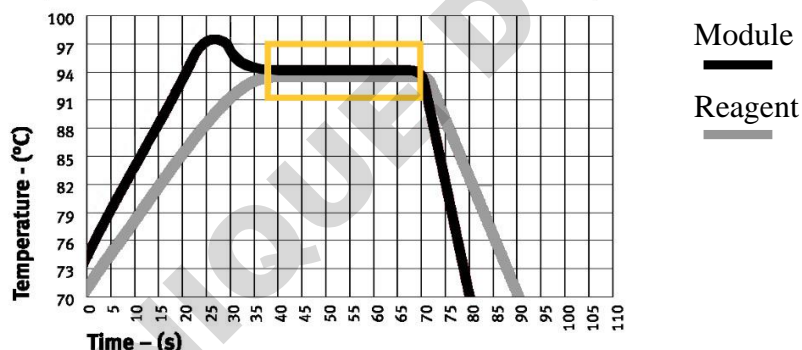

4 File management

Click **Open Experiment** on the main interface to enter the interface of file management.

Click the dropdown list on the upper left to select disk for operation. For example, select USB flash disk to operate on USB flash disk contents/GeneExplorer.

- ✧ Press “**New Experiment**” to enter the interface of experiment parameter setting.
- ✧ Press “**Run**” to enter the interface of run.
- ✧ Press “**Export**” to export file or user.
- ✧ Press “**Function**” to delete and rename file or user.



New Experiment

Click  to enter into user management.



Press “Function” to delete or rename user.

Select user to export to USB flash disk.

Click “Manage File”



Press “Function” to delete or rename file.

Select file to export to USB flash disk.

5 System settings

Click “System Settings” on the main interface to enter the interface of setting which includes two major functions which are System Settings and Personal Center.



5.1 Personal Center

In Personal Center, you can log on with registered account, or log out.

5.2 System Settings

System Settings include the following 10 settings:

1. Network setting
2. Http remote access
3. Hot lid related
4. Time and date: set instrument time, and it will display on the lower right corner of the main interface
5. Instrument part use time
6. Dairy
7. About instruments
8. Tm calculation
9. Buzzer setting
10. Exit: exit system software

6 Software upgrade

6.1 UI program upgrade

Copy file to USB flash disk \version\update

Enter into System Settings->about instruments, select Firmware upgrade/

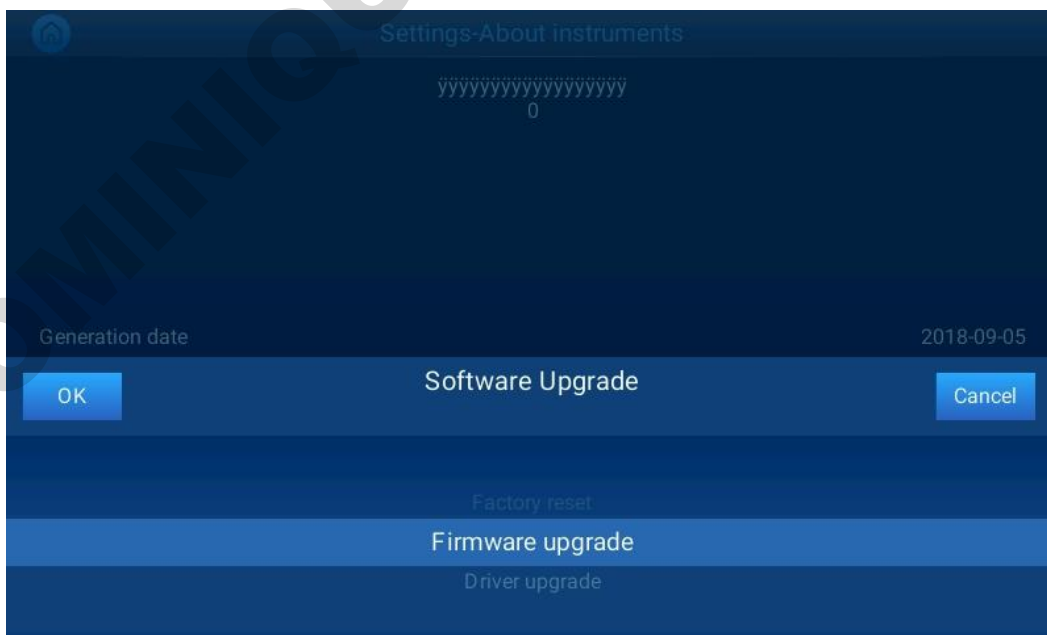

For setting menu, please pay attention to the capitalization of letters.

6.2 Driver upgrade

File Copy to USB flash disk /GeneExplorer location

Enter into System Settings->about instruments, select driver upgrade/

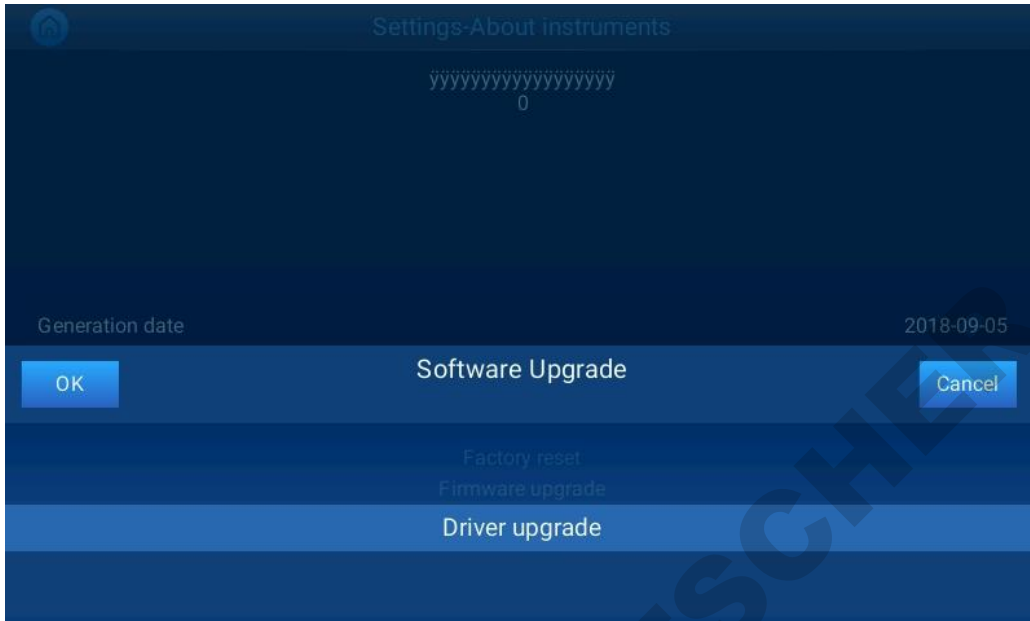

Chapter Five Fault Analysis and Troubleshooting

The chapter mainly introduces possible faults of the instrument, cause analysis and troubleshooting.

1 Fault analysis and troubleshooting

No.	Fault	Cause analysis	Troubleshooting
1	After the power switch is turned on, the display screen doesn't work.	Disconnecting power supply	Check and connect the power supply
		Burned fuse	Replace fuse (250V 12A Φ 5x20)
		Damaged switch	Replace switch
		Others	Contact supplier or manufacturer
2	During file running, it shows "Err code: 0x**0000**", and prompts "Please Contact the Manufacturer"	Module sensor damage or loose contact	Contact supplier or manufacturer
		Radiator sensor damage or loose contact	
		Hot lid sensor damage or loose contact	
3	Evident change of module temperature rise rate or imprecise temperature control	Blocked ventilation holes	Remove the blocking objects on ventilation holes
		Loose connecting line	Open the shell and check the connecting line; tighten the screw of the terminal block if it is loose.
		Damaged TEC	Contact supplier or manufacturer
4	Evident slowing module temperature fall rate or failure to fall below ambient temperature	Ambient temperature or humidity is too high, and exceeds using condition of the instrument	Please properly adjust ambient temperature and humidity
		Damaged TEC	Contact supplier or manufacturer
		Damaged or un-working fan	
5	Temperature not changing	Damaged temperature sensor	Contact supplier or manufacturer
		Damaged TEC	
6	The module fails to heat	On system parameter setting interface, hot lid status is set as "OFF".	Set the hot lid status as specific temperature value
		Temperature control time on file editing interface is set as "--:--", leading to automatic turning off of hot lid	Set temperature control time in digital form
		Loose connector	Contact supplier or

		Damaged heating component in hot lid	manufacturer
		Damaged temperature sensor in hot lid	
7	Abnormal characters displayed on screen	Loose contact of PCB	Contact supplier or manufacturer
		Damaged PCB	
8	Reagent evaporation in reaction tube	Hot lid temperature is not set, hot lid is set as "OFF".	When setting parameters for running file, select ON for hot lid control and set proper temperature
		Uneven distribution of reaction tubes	Adjust reaction tube distribution to ensure symmetry.
		Untightened PCR tube caps	Close reaction tubes tightly and then put into the instrument

Explanation for Err code: 0x0000*** is as below:**

0X	Left sensor	Right sensor	Reserve d	Reserve d	Reserve d	Reserve d	Single module hot lid/double-module hot lid A	Double-module hot lid B	Radiator
----	-------------	--------------	-----------	-----------	-----------	-----------	---	-------------------------	----------

0 normal 1 open circuit alarm 2 short circuit alarm/over-temperature radiator alarm

Attention:

1. During the warranty period, user is strictly prohibited from opening the shell of the instrument for inspection. In case of any fault requiring opening the shell for inspection, user should timely contact supplier or manufacturer.
2. As temperature control features (including ramp rate, stability and volatility) differ for various brands and instruments, also due to the uncertainty of bio-experiments which can be easily affected by external environment, PCR program of successful running on one instrument may not achieve the equal effect on another. Therefore, when you are changing an instrument, you may need to adjust the PCR running program for an ideal effect.

Appendix 1 Wiring Diagram (the diagram is only for reference, and please understand that no further notice will be given for any modification)

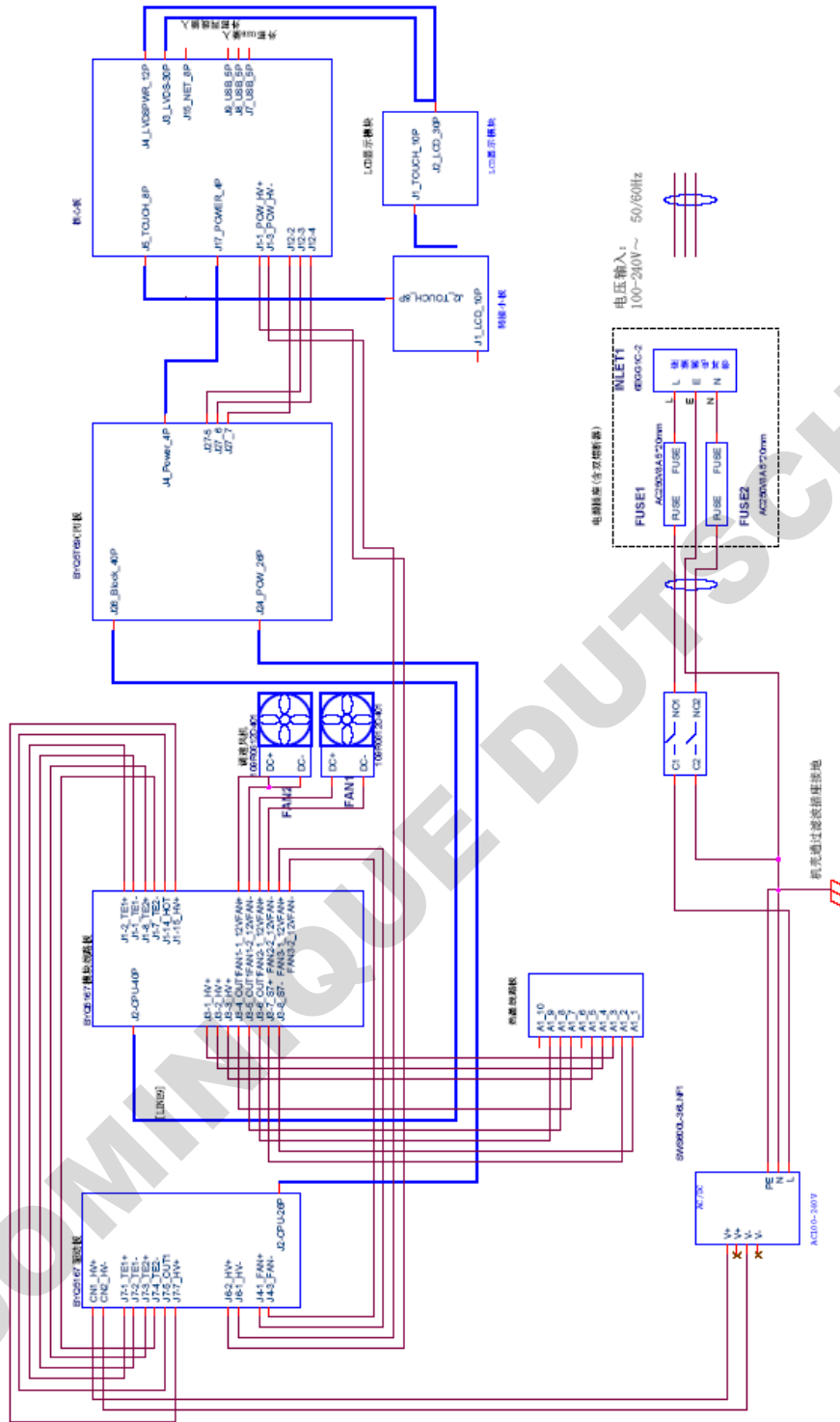

Appendix 2 Value and Meaning of Set Parameters

No.	Parameter	Meaning	Set value range	Remark
1	Temp(C)	Temperature control point (C)	4.0~99.0	
2	Time	Temperature control time (mm:ss)	--:-- (press "+/-" key before "." to set)	Infinite temperature control time and turn off hot lid in the meantime
			00:00~59:59	
3	Ramp(C/S)	Temperature heating and cooling rate (C/s)	GE-48DG,GE-48DS, GE-96S: 0.1-6.0 GE-96G,GE-48D:0.1-5.0 GE-384G,GE-4I:0.1-4.0	
			0 #.#	Max. ramp rate
4	+Temp	Temperature increase for each cycle (C)	0.0~9.9	
5	+Time	Time increase for each cycle (m:ss)	0:00~9:59	
6	Cycle1	Number of the cycle	1~5	Cycle1:×00 From 00 to 00
	×00	Times of the cycle	1~99	
	From 00	Starting section of the cycle	X(any existing section number)	
	to 00	Ending section of the cycle	≤X+15	
7	Grad.	Gradient temperature (C)	0 ~30	For GE-48D, GE-4I, do not have the parameters.
8	Date	Date (YY-MM-DD)	00(~99)-01(~12)-01(~31)	YY-MM-DD
9	Time	Time (HH:MM:SS)	00:00:00~23:59:59	HH:MM:SS
10	Default File	System default file name	Max. 11 characters	
11	Default User	System default user name	Max. 11 characters	
12	Control Mode	Temperature control mode	Block	In this mode (enter into constant temperature status after reaching set temperature), the time for reagent at set temperature is less than the set time (see Fig. 1).

			Tube	In this mode (enter into constant temperature status when overshoot for about 3°C after reaching set temperature), reagent temperature can get close to the set temperature more quickly (see Fig. 2).
13	Sample Volume	Sample volume (ul)	10~200	
14	Holid	Hot lid off	Off	
		Hot lid on (°C)	30~110	
15	Key Sound	Key sound (yes/no)	Yes/No	Buzz
16	Run End Sound	Run end sound (yes/no)	Yes/No	Intermittent buzz



图1



图2

Appendix 3 Product EMC Statement

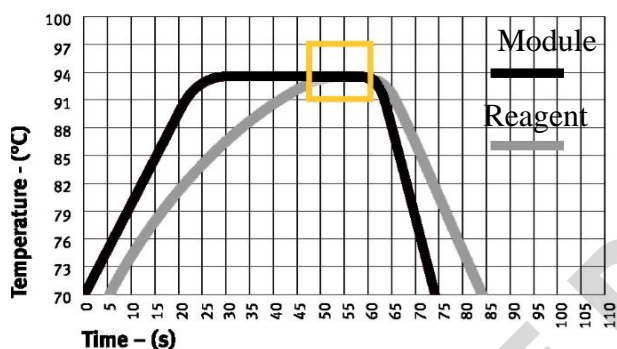
Class-I Type-A Equipment

If the instrument is used under dry environment, especially under dry environment where artificial materials (artificial fabrics, carpet, etc.) present, electrostatic discharge may be generated which may lead to false conclusion.

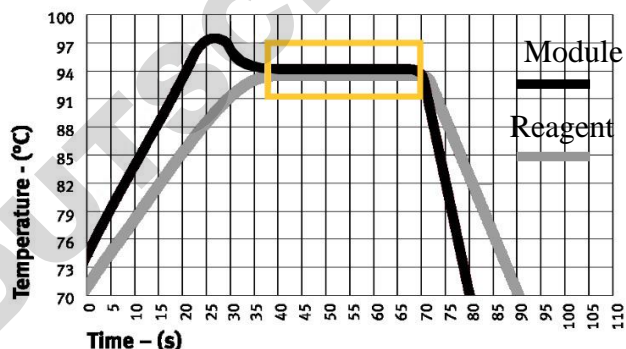
The instrument is strictly prohibited from using near strong radiation source; otherwise, normal equipment operation may be interrupted.

EMC should be in line with the requirements of GB/T 18268.1-2010 and GB/T 18268.26-2010.

1. Requirements for immunity:

Table 1 Requirements for equipment immunity

Port	Test item	EMC basic standard	Test value	Performance criterion
Shell	Electrostatic discharge (ESD)	GB/T 17626.2	Air discharge:2kV,4kV,8kV; Contact discharge:2kV,4kV	B
	Radiation magnetic field	GB/T 17626.3	3V/m,80MHz-2.0GHz,80% AM	A
	Rated PFMF ^a	GB/T 17626.8	3A/m,50Hz	A
AC	Voltage sag ^d	GB/T 17626.11	1 cycle 0%;	B
			5 cycle 40%	C
			25 cycle 70%	C
	Voltage interruption ^d	GB/T 17626.11	5%, duration:250 cycle	C
	Pulse group	GB/T 17626.4	1kV(5/50ns.5kHz)	B
	Surge	GB/T 17626.5	Line to ground:2kV/ Line to ground:1kV	B
Radio frequency transmission	GB/T 17626.6	3V,150kHz-80MHz,80% A M	A	
DC ^c	Pulse group	GB/T 17626.4	1kV(5/50ns.5kHz)	Not applicable
	Surge	GB/T 17626.5	Line to ground:2kV/ Line to ground:1kV	Not applicable
	Radio frequency transmission	GB/T 17626.6	3V,150kHz-80MHz,80% A M	Not applicable
I/O signal ^b	Pulse group	GB/T 17626.4	0.5kV(5/50ns.5kHz)	Not applicable
	Surge	GB/T 17626.5	/	Not applicable
	Radio	GB/T 17626.6	3V,150kHz-80MHz,80% A	Not

	frequency transmission		M	applicable
I/O signal to main power supply	Pulse group	GB/T 17626.4	1kV(5/50ns.5kHz)	Not applicable
	Surge	GB/T 17626.5	/	Not applicable
	Radio frequency transmission	GB/T 17626.6	3V,150kHz-80MHz,80% A M	Not applicable
<p>A The test is applicable only to equipment potentially sensitive to magnetism. CRT display interruption value is allowed to be higher than 1A/m.</p> <p>B Only applicable to cables longer than 3m.</p> <p>C Not applicable to input port expected to connect to battery or chargeable battery (before recharging, it should be removed or disconnected from the equipment). For equipment with DC power input port (using AC-DC power adapter), test should be conducted on AC input port of AC-DC power adapter specified by the manufacturer. If there is no specific requirement, typical AC-DC power adapter should be adopted. The test is applicable to DC power input port designed for extended long distance connection.</p> <p>D “5/6cycle” refers to “5 cycles under 50Hz test” and “6 cycles under 60Hz test”.</p>				

2. Requirements for radiation:

Table 2 Requirements for equipment radiation

Radiation test	Compliance
Radio-frequency emission GB 4824	Class 1
Radio-frequency emission GB 4824	Type A

The equipment is designed and tested based on Type-A equipment in GB4824. In family environment, the equipment may cause radio interference, and thus protective measures should be taken.

Electromagnetic environment evaluation is suggested before the equipment use.

Appendix 4 List of Accessories

No.	Name	Model & Specification	Unit	QTY	Remark
1	Power line (with shield magnetic ring clamp)	250V10A	String	1	Accessory
2	Fuse	250V12A, $\Phi 5 \times 20$	Piece	2	Accessory
3	WiFi Module		Piece	1	Accessory
4	Ethernet Patch Cable		Piece	1	Accessory
5	Compression Pad		Piece	2	Accessory
6	Pressure Balancing Plate		Piece	1	Accessory

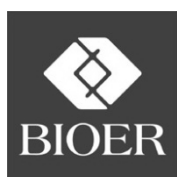

Hangzhou Bioer Technology Co., Ltd.



Hangzhou Bioer Technology Co., Ltd.

Add: 1192 BinAn Rd, Binjiang District, 310053 Hangzhou,

PEOPLE'S REPUBLIC OF CHINA

Website: www.bioer.com.cn

Tel:+86-571-85800535, 87774558

Fax:+86-571-85800537, 87774559

E-mail: instrument@bioer.com.cn



MedNet EC-REP GmbH

Borkstrasse 10, 48163 Muenster, Germany