



# NanoReady User's Manual



Hangzhou Lifereal Biotechnology Co., Ltd.

---

**Note:** The LifeReal Co. reserves the right to modify this manual at any time without notice.

---

Patent materials are included in this manual. All rights reserved. Any part of this manual shall be forbidden to photocopy, reproduce, or translate into other languages, without written permission from Hangzhou Lifereal Biotechnology Co.,Ltd.

***Thanks for your selecting this kind of instrument.***

## Important Note

### 1. Conventions



#### NOTE

Please read it carefully, for there is important information in this column. Failure to follow the advice in this column will possibly result in damage to or the malfunction of the product.

---



#### WARNING

This symbol means that you should be cautious when performing an operation/procedure. Failure to follow the requirements in this column may result in personal injury.

---

### 2. Safety

During the whole operation, maintenance, and repair of the instrument, the following safety measures and warning should be followed. Otherwise, the guard provided by the instrument may be damaged, while the rated safety level to be reduced, and the rated operation conditions to be affected.

Lifereal shall not be in any way responsible for the consequences resulted from operators not following the requirements.

---

**Note:** This instrument complies with the following standards:

- Chinese safety requirements for electrical for measurement control and laboratory use: Level I device, Safety level IP20 under GB4793.1.
  - This instrument is for indoor use only.
- 

#### 1) Grounding Considerations

A.C. power's grounding should be grounded reliably for fear of an electric shock. The 3-pin plug with the instrument's power line is a safety device that should be matched with a grounded socket. Never let the third ground pin floating. If the 3-pin plug cannot be inserted, it is recommended to ask an electrician to install an appropriate power socket.

#### 2) Keep Away from Electric Circuits

The operator is not allowed to open the Instrument. To changing components or adjust certain parameters inside the device must only be accomplished by the certificated professional maintenance personnel. Do not change elements while the power is still on.

#### 3) Power supply

Before turn on the power, always check if the output voltage of power adapter is within the required power (12V) and ensure that the rated load of the power outlet is not less than the maximum load of the instrument 30W.

#### 4) Power line

As an accessory of the Instrument, the power line used should be a default one. If it is damaged, the power line may not be repaired, but could be replaced by a new one with same model and specification.

The power line should be free of heavy objects during the Instrument's operation. Keep the power line away from the place where people gather regularly.

5) Connect the power line

While connect or disconnect the power line, you should hold the plug with your hand. Insert the plug thoroughly to ensure good contact between the plug and socket. Pull the plug, but not the line, when you need to disconnect to the mains.

6) Pay attention to the placement of the instrument

The instrument should be placed in a place where there is no corrosive gas or smoke, and there should be no strong light, strong airflow or strong magnetic field interference in the room. The workbench on which the instrument is placed should be level and stable.

Turn off the power when you stop working. When not using the instrument for a long time, turn off the power, unplug the power cord, and cover the instrument with a soft cloth or plastic film to prevent dust and foreign matter from entering.

7) Operational attention

- Avoid liquid dripping on the surface of the instrument during the test operation.
- When experimenting in pedestal mode, the sample should be added to the corresponding position of the instrument;
- Place the cuvette in the appropriate position of the instrument when experimenting in cuvette mode.

---

**Note:** Once one of the following events occurs, you are suggested to disconnect the power line with mains, and contact the distributor or ask a certificated maintenance personnel for help.

- Liquid into the device
  - The device sprinkled or drenched
  - The device malfunctioning, giving off abnormal sound or odor
  - The device falling onto the floor or its shell damaged
  - The instrument function has changed significantly.
- 

### 3. Labels

Instrument labels for different models as below:

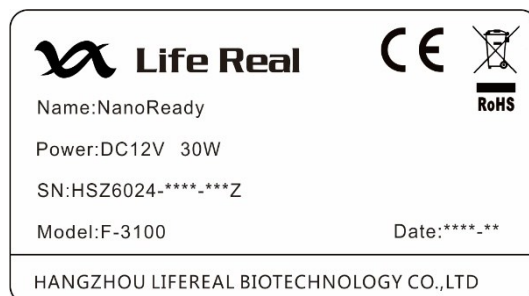
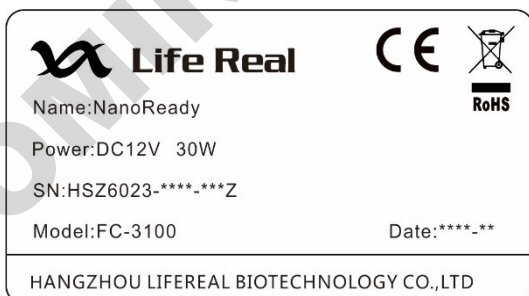

### 4. Maintenance

After the pedestal mode inspection is completed, clean the sample on the upper and lower pedestals with a

airlaid paper to prevent the residue on the pedestal from affecting the next test.



**WARNING**

When cleaning, the instrument should be off and don't use water to clean the instrument.

Corrosive scour is not allowed to clean the surface of the instrument.

---

## 5 Warranty and after service information

### a) Warranty content

Since the date of acceptance, the whole machine warranted for 12 months.

### b) Warranty limitations

The above warranty is not applicable to defective devices with incorrect use, abnormal operating conditions, improper application, and unauthorized maintenance or alteration.

After the warranty comes due, LifeReal reserves the right to charge cost price for maintenance of a defective device and all related service charges.

---

**Note:** Once it is opened, the package should be checked according to the packing list. If the buyer finds any items to be missing or damaged, do not hesitate to contact the distributor.

Please store the package and packing materials in a safe place in case of future device maintenance. The above warranty does not extend to goods damaged as the result of cheesy package.

---

## CONTENTS

1. Instrument Introduction.....	1
2. Instrument Specifications and Operation notes.....	3
2.1 Instrument Specifications.....	3
2.2 Cable Connections .....	4
2.3 Pedestal mode.....	4
2.3.1 Pedestal Measurements.....	4
2.3.2 Pedestal Sample Volume Requirements .....	5
2.3.3 Basic Use of the pedestal.....	5
2.4 Cuvette mode.....	6
2.4.1 Cuvette Measurements .....	6
2.4.2 Cuvette Sample Volume Requirements .....	6
2.4.3 Basic Use of the Cuvette.....	6
2.5 Blank and Absorbance Calculations.....	7
2.6 Dye Editor .....	8
3 Software .....	9
3.1 Software Upgrade.....	9
3.2 Software Features .....	13
3.2.1 Measurement Page .....	13
3.2.2 Parameter Settings.....	17
3.3 Software Measurement Example .....	19
4 Application.....	21
4.1 Overview .....	21
4.2 Measurement.....	21
5 Instrument function.....	22
5.1 dsDNA.....	22
5.1.1 Overview.....	22
5.1.2 dsDNA Concentration Calculation.....	22
5.1.3 Nucleic acid Concentration Measurement .....	23
5.2 ssDNA.....	24
5.2.1 Overview.....	24
5.2.2 ssDNA Concentration Calculation.....	24
5.2.3 Nucleic acid Concentration Measurement .....	25
5.3 RNA.....	26
5.3.1 Overview.....	26
5.3.2 RNA Concentration Calculation.....	26
5.3.3 Nucleic acid Concentration Measurement .....	27
5.4 Micro Array.....	28
5.4.1 Overview.....	28
5.4.2 Measurement Concentration Ranges .....	28
5.4.3 Dye Editor.....	28
5.4.4 Micro Array Measurement.....	29
5.5 Oligo DNA.....	30
5.5.1 Overview.....	30

5.5.2 Oligo DNA Concentration Calculation .....	30
5.5.3 Oligo DNA Concentration Measurement.....	31
5.6 Oligo RNA .....	32
5.6.1 Overview.....	32
5.6.2 Oligo RNA Concentration Calculation.....	32
5.6.3 Oligo RNA Concentration Measurement.....	33
5.7 Custom.....	34
5.7.1 Overview.....	34
5.7.2 Custom Concentration Calculation.....	34
5.7.3 Custom Nucleic Acid Concentration Measurement .....	35
5.8 Protein A280 .....	36
5.8.1 Overview.....	36
5.8.2 Measurement Concentration Range .....	36
5.8.3 Protein A280 Measurement.....	37
5.9 Protein&labels.....	38
5.9.1 Overview.....	38
5.9.2 Measurement Concentration Range .....	38
5.9.3 Dye Editor.....	38
5.9.4 Protein&labels Measurement.....	39
5.10 Protein A205 .....	40
5.10.1 Overview.....	40
5.10.2 Measurement Concentration Range .....	40
5.10.3 Protein A205 Measurement .....	41
5.11 Protein BCA .....	42
5.11.1 Overview.....	42
5.11.2 BCA Measurement Range .....	42
5.11.3 BCA Standard Curve Line.....	43
5.11.4 Perform BCA Measurement .....	43
5.12 Protein Bradford.....	44
5.12.1 Overview.....	44
5.12.2 Bradford Measurement Range.....	44
5.12.3 Bradford Standard Curve Line .....	45
5.12.4 Perform Bradford Measurement.....	45
5.13 Protein Lowry.....	46
5.13.1 Overview.....	46
5.13.2 Lowry Measurement Range .....	46
5.13.3 Lowry Standard Curve Line.....	47
5.13.4 Perform Lowry Measurement.....	47
5.14 Protein Pierce 660 .....	48
5.14.1 Overview.....	48
5.14.2 Pierce 660 Measurement Range .....	49
5.14.3 Standard curve .....	49
5.14.4 Performing Protein Pierce 660 Measurement.....	49
5.15 OD600.....	50
5.15.1 General.....	50
5.15.2 Perform OD600 concentration measurement .....	51

5.16 UV-VIS .....	52
5.16.1 General .....	52
5.16.2 Measurement concentration range .....	52
5.16.3 Performing UV-visible inspection .....	53
5.17 Kinetics .....	54
5.17.1 General .....	54
5.17.2 Measurement range .....	54
5.17.3 Kinetic measurements .....	54
5.17.4 Create a kinetics method .....	55
5.17.5 Editing a kinetics method .....	56
6. My data and Settings .....	58
6.1 My data .....	58
6.1.1 Introduction .....	58
6.1.2 My Data main function .....	58
6.2 Settings .....	59
6.2.1 System settings .....	60
6.2.2 General Settings .....	60
6.2.3 Dye Editor .....	62
6.2.4 Protein Editor .....	63
7 Diagnosis .....	65
7.1 Spectrum intensity diagnosis .....	65
7.1.1 Pedestal spectrum intensity diagnosis .....	65
7.1.2 Cuvette spectrum intensity diagnosis .....	66
7.2 Spectral diagnosis .....	66
8. Alarms and tips .....	68
8.1 This experiment data is abnormal .....	68
8.2 The xenon lamp is abnormal .....	68
8.3 Spectrometer communication failed .....	68
8.4 Base motor is abnormal .....	68
8.5 The pedestal motor is blocked .....	68
8.6 The pedestal channel was not found .....	68
8.7 The cuvette channel was not found .....	68
8.8 Communication failed .....	68
8.9 The operation timed out .....	68
8.10 Initialization failed .....	68
8.11 Can't find the available installation package .....	68
8.12 Unable to get the installation package information .....	68
8.13 Upgrade failed .....	69
8.14 No U disk found .....	69
8.15 U disk removed,export failed .....	69
8.16 Upgrade failed .....	69
8.17 Please close the lid .....	69
8.18 Please add sample again .....	69
8.19 The starting sequence number cannot be larger than the ending sequence number .....	69
8.20 The Starting sequence number cannot be 0 .....	69
8.21 Maximum input * .....	69



8.22 File already exists.....	69
8.23 The file type is incorrect.....	70
8.24 The file you selected does not exist, please re-select .....	70
8.25 Please connect the instrument first .....	70
8.26 Connection failed, please reconnect.....	70
8.27 The instrument is measuring, please try again later .....	70
8.28 The same file name exists. Please close the file before proceeding.....	70
8.29 Starting time cannot be larger than the ending time .....	70
9 Failures and troubleshooting.....	71
10 Use and maintenance .....	72
10.1 Pedestal Maintenance .....	72
10.1.1 Sample Compatibility Instructions.....	72
10.1.2 Pedestal use and maintenance.....	72
10.2 Machine use and maintenance.....	72

DOMINIQUE DUTSCHER SAS

## 1. Instrument Introduction

NanoReady Touch F(C)-3100 is a micro-volume UV-Vis Spectrophotometer for measuring the absorbance of entire wavelength (185-910nm). It access both Pedestal (as position 1 shown in Picture 1-1) measurement for small volume sample and the traditional Cuvette (as position 2 shown in Picture 1-1) measurement.

In pedestal measurement, NanoReady Touch can measure 0.5-2 $\mu$ L samples with high accuracy and reproducibility. The sample retention system employs surface tension to hold the sample in the place between two optical fibers. This enables the measurement of very highly concentrated samples without the need for dilutions. Using this technology, NanoReady Touch has the capability to measure sample concentration up to 200 times higher than the samples measured by a common spectrophotometer. Height of liquid between optical fibers can be adjusted in real-time way to get more precise data. Compared with traditional cuvette measurement, there is no need to do washing for cuvettes. Wipe pedestal with a dry lint free-laboratory wipe is much more convenient. For samples with low concentration, high volatile and low surface tension which are hard to form liquid bridge, cuvette measurement is recommended.

When powered on, it runs the self-testing (as shown in Picture 1-2). When self-testing finished, it is as shown in Picture 1-3. There is no need to preheat before measuring. All operations are simple and convenient. Moreover, this instrument is easy to be carried with the small dimension and light weight.

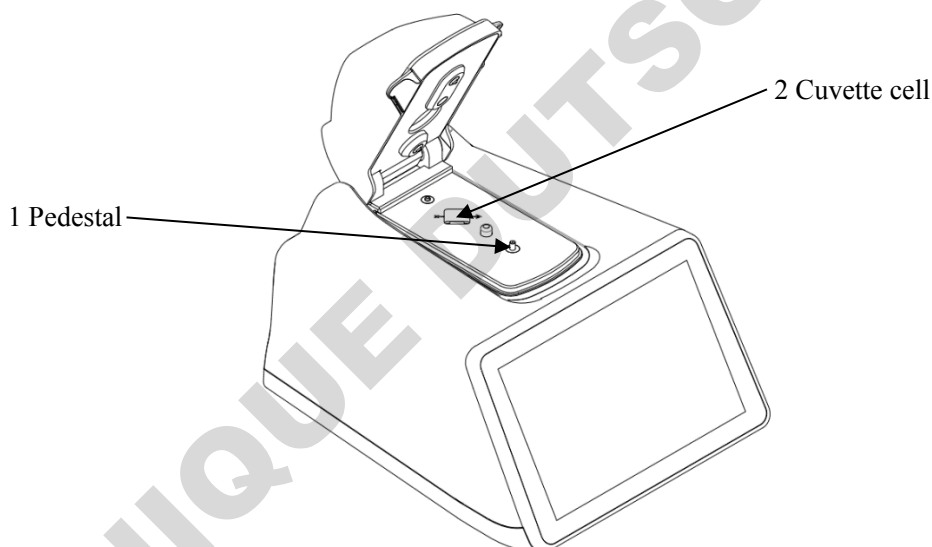

Picture 1-1

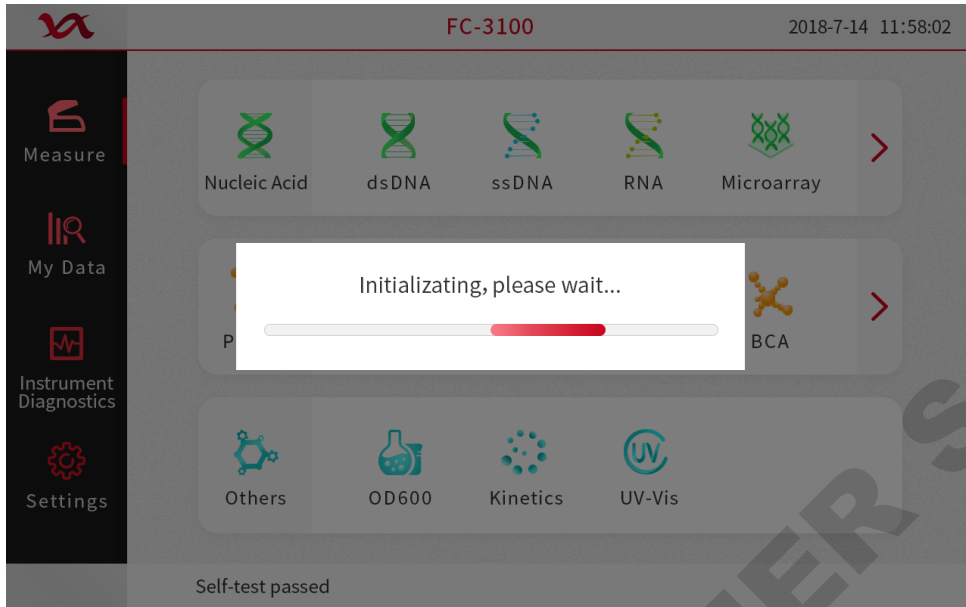

Picture 1-2

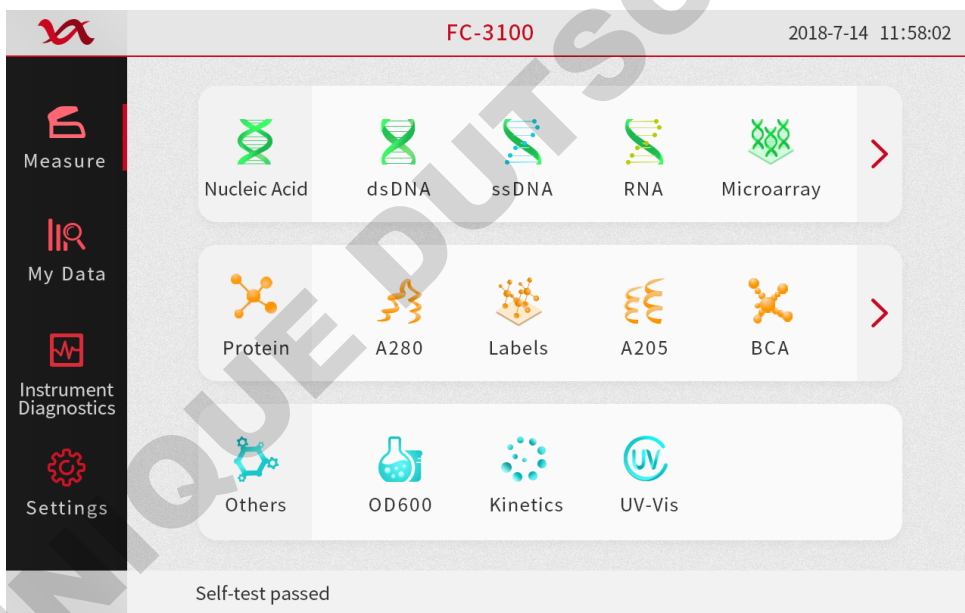

Picture 1-3

## 2. Instrument Specifications and Operation notes

### 2.1 Instrument Specifications

**Table 2.1 Instrument Specifications**

Item		FC-3100	F-3100
Detector Type		2048-element linear CCD array	
Light source		xenon flash lamp	
Minimum Sample volume ( $\mu$ l)		0.5	
Light pathlength (mm)		0.03,0.05,0.1,0.2, 1.0 auto-ranging	
Wavelength upgrade		Not available	
Wavelength range (nm)		185-910nm	
Wavelength accuracy(nm)		$\pm 1$	
Spectral bandwidth (nm)		$\leq 1.8$ (FWHM at Hg 253.7nm)	
Measuring time		$\leq 5$ s	
Absorbance Accuracy		0.002Abs(1mm path) or 1%CV, whichever is bigger	
Absorbance Precision		$\pm 2\%$ (at 0.86A at 257nm)	
Pedestal Minimum Concentration		2ng/ $\mu$ l dsDNA	
Pedestal Maximum Concentration		27500ng/ $\mu$ l dsDNA	
Photometric(Abs)		0-550(10mm equivalent)	
Cuvette	Heating ( $^{\circ}$ C)	37 $\pm$ 0.5	-
	Stirrer (RPM)	10-900RPM 10 speeds	-
	Photometric	0-1.5A (10mm)	-
	Limit of detection	0.2ng/ $\mu$ L dsDNA	-
Display		7 inch, 1280*800 high definition LCD, Multipoint capacitive touch, Gesture recognition	
Operating system		Android	
Internal storage		8GB	
Data transfer connector		USB, WIFI	
Power supply		AC110V-220V, 50Hz/60Hz by power adapter	
Net WT.		2.3KG	2.2KG

## 2.2 Cable Connections

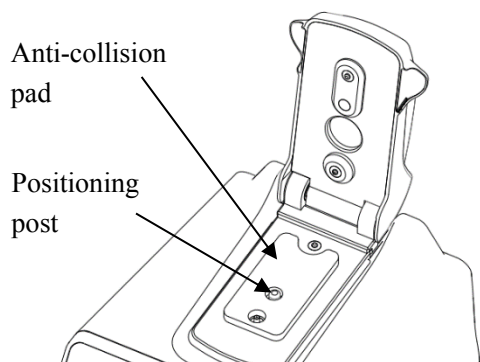

Picture 2-1

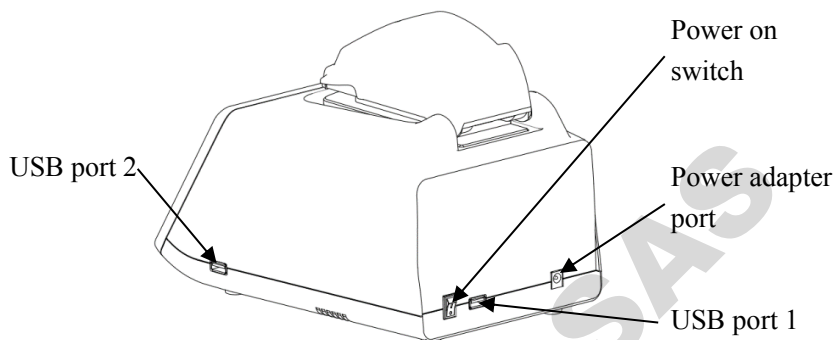

Picture 2-2

As shown in Picture 2-1, before the instrument power switch is turned on, open the flip cover and remove the anti-collision pad, then gently lower the flip cover. The anti-collision pad prevents the flip cover from colliding with the positioning post during the movement of the instrument. After the instrument is used, it is recommended to put the anti-collision pad back to the position shown in Picture 2-1.

As shown in Picture 2-2, please plug in the 12V power supply and connect to the power adapter port before using the instrument.

As shown in Picture 2-3, when the pedestal mode and the cuvette mode are switched, the screen pops up the channel switching progress prompt. Do not open the flip cover during the channel switching process, and wait for the channel to switch successfully before proceeding to the next step.

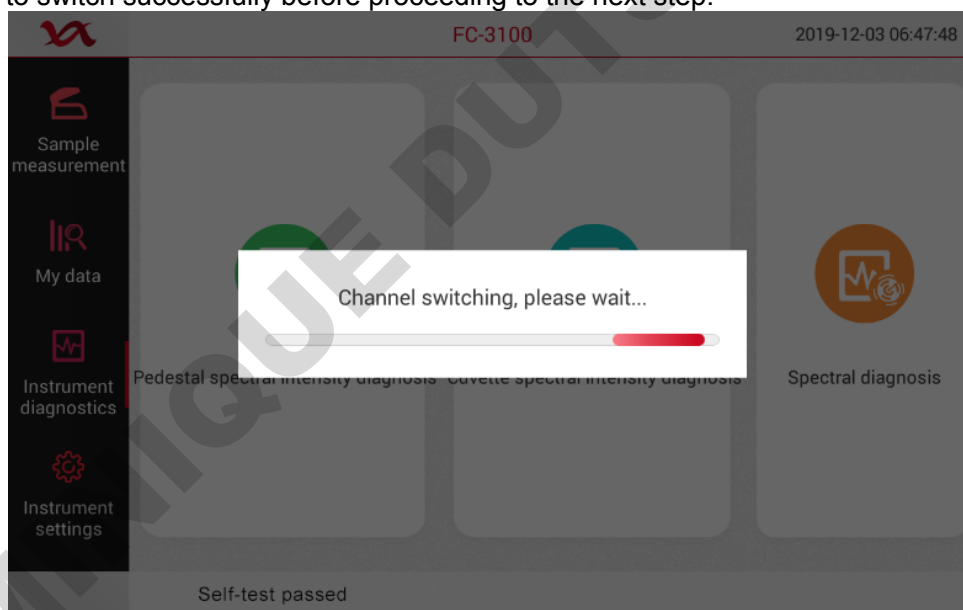

Picture 2-3

## 2.3 Pedestal mode

### 2.3.1 Pedestal Measurements

Pipette 1 – 2µL sample onto the pedestal. A smaller, 0.5µL volume sample, may be used for high concentrated nucleic acid or protein A280 samples. A fiber optic cable (the receiving fiber) is embedded within the pedestal. Add the sample to the pedestal. And the second optic fiber (the light source fiber in the lid) is then brought down into the contact with the liquid sample causing the liquid to the column between the gaps of the ends of the two fibers. A pulsed xenon flash lamp provides the light source and a spectrometer utilizing a linear CCD array analyzes the light passing through the sample column.

### 2.3.2 Pedestal Sample Volume Requirements

Although sample size is not critical, it is essential that a liquid column is formed when using the pedestal mode so that the pathlength between the upper and lower measurement pedestals is bridged with sample.

The dominant factor determining the surface tension of a droplet is the hydrogen bonding of the lattice of water molecules in solution. Generally, all additives (including protein, DNA, RNA, buffer salts and detergent-like molecules) can reduce the surface tension by interfering with the hydrogen bonding between water molecules. Although 1 $\mu$ L volumes are usually sufficient for most sample measurements, increasing the sample size to 2 $\mu$ L will ensure proper column formation for samples with reduced surface tension.

Field experience indicates that the following volumes are sufficient to ensure reproducibility:

Aqueous solutions of nucleic acids: 1 $\mu$ L

Pure protein: 2 $\mu$ L

Bradford, BCA, Lowry or Protein Pierce 660nm assays: 2 $\mu$ L

Microbial cell suspensions: 2 $\mu$ L

It is best to use a precision pipette (0-2 $\mu$ L) with precision tips to ensure that sufficient sample (1-2 $\mu$ L) is delivered. Lower precision pipettes (0-10 $\mu$ L and larger) are not good at delivering 1 $\mu$ L volumes to the measurement pedestal. If the user is unsure about the sample characteristics or pipette accuracy, a 2 $\mu$ L sample volume is recommended.

### 2.3.3 Basic Use of the pedestal

1. Raise the lid (Position 3 in Picture 2-4) and pipette the sample onto the lower measurement pedestal. (Position 1 in Picture 2-4)
2. Lower the lid and initiate a spectral measurement using the software on the display (Position 2 in Picture 2-1). Please click the baseline correction during measurement. The sample column is automatically drawn between the upper and lower pedestals and then the measurement is made.
3. When the measurement is complete, raise the lid and wipe the sample from both the upper and lower pedestals using an airlaid paper. Simple wiping prevents sample carryover in subsequent measurements. (Position 1&4 in Picture 2-4)

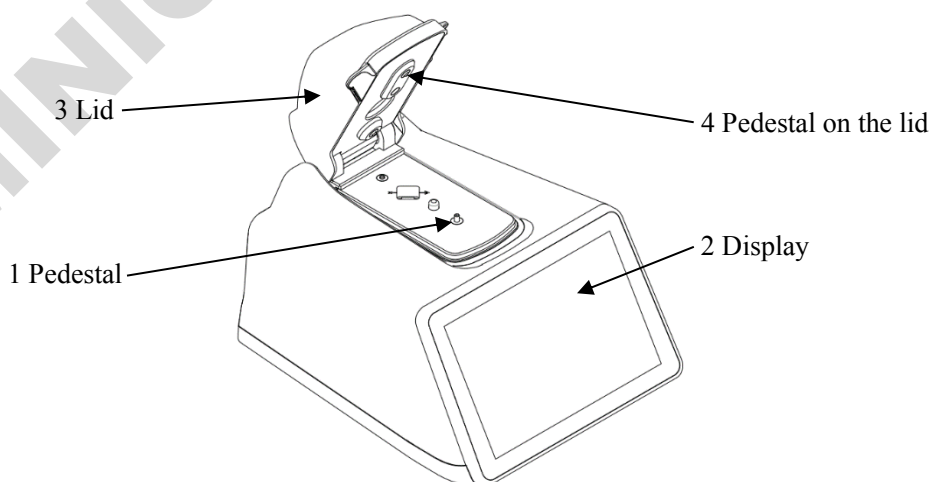

Picture 2-4

## 2.4 Cuvette mode

### 2.4.1 Cuvette Measurements

The NanoReady accepts 10,5,2,1 mm cuvettes 45 to 48 mm. When measuring samples using micro, semi-micro, or ultra-micro cuvettes, we recommend using opaque cuvettes. The opaque cuvettes ensure that all lights hitting the detector has passed through the sample. Transparent cuvettes can allow light to the detector without passing through the sample, which will lead to significant measurement errors, especially for the low concentration sample.

When measuring samples in the wavelengths of the Ultra violet (<340 nm), use cuvettes made of quartz, as it can pass UV wavelengths. Although some manufacturers offer "UV permeable" plastic disposable cuvettes, even the best of it is not permeable when the wavelengths below 220 nm; most plastic and glass cuvettes block UV wavelengths entirely.

While matched cuvettes have been recommended for single-beam spectrophotometers, many cuvette manufacturers have sufficient controls over their manufacturing process to deliver excellent cuvette-to-cuvette performance without requiring calibration. These cuvettes should be sufficient for measurements with the NanoReady.

### 2.4.2 Cuvette Sample Volume Requirements

It is essential to ensure that the sample volume in the cuvette is adequate to allow the light to pass through a representative portion of the sample when making a measurement. The optical beam (2 mm width) is directed on the 8.5 mm above the bottom of cuvette. Refer to the cuvette manufacturer for volume recommendations.

### 2.4.3 Basic Use of the Cuvette

1. Prepare two cuvettes. Add the blank calibrating solution to one cuvette. Add the sample to the other cuvette and ensure that the volume is sufficient to cover the light path. The light path (2mm in width) is located on 8.5mm above the bottom of cuvette. Also please follow the advice from manufacturer of cuvette to add solution.
2. Raise the lid and insert the cuvette into the cuvette well. Insert the cuvette noting the translucent surface (as shown in Picture 2-5) should correspond to the direction of the light path on the instrument (as arrow direction shown in Picture 2-5).

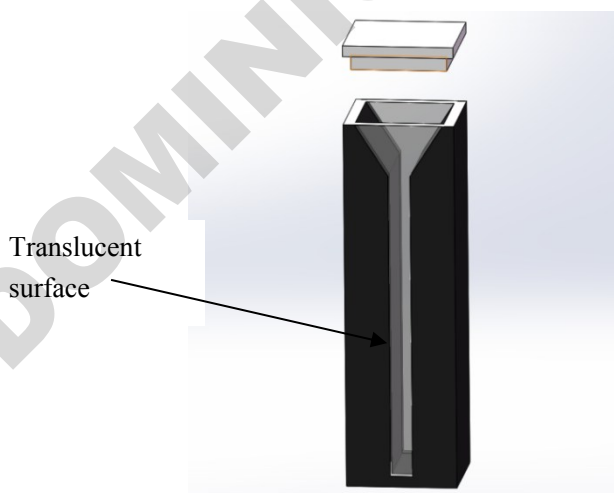

Picture 2-5

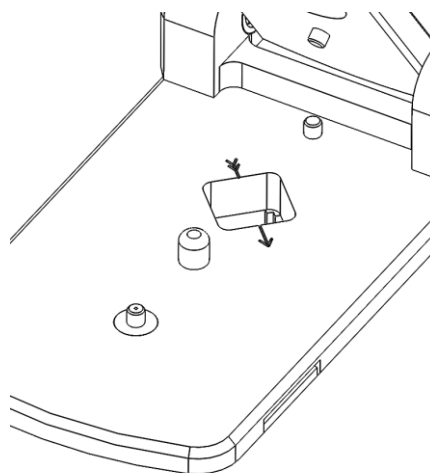

Picture 2-6

3. The lid must be lowered during the cuvette measurements.
4. Click the “Settings” button on the main of the display to enter the settings page, click on “General Settings”, select “Using a cuvette”, insert the cuvette, check the baseline correction, set the corresponding parameters and the start the blank measurement and measure.
5. When the measurements are complete, remove the cuvette, pour out the sample, and clean the cuvette.

## 2.5 Blank and Absorbance Calculations

When the instrument is blanked, a spectrum is taken of the reference solution (blank) and stored in memory as an array of light intensities by wavelength. When a measurement of a sample is taken, the intensity of light that was transmitted through the sample is recorded. The sample intensities along with the blank intensities are used to calculate the sample absorbance according to the following equation:

$$\text{Absorbance} = -\log\left[\frac{\text{Intensity}_{\text{sample}}}{\text{Intensity}_{\text{blank}}}\right]$$

Thus, the measured light intensity of both the sample and of the blank are required to calculate the absorbance at a given wavelength.

The Beer-Lambert equation is used to correlate the calculated absorbance with concentration:

$$A = \epsilon * b * c$$

A=the absorbance represented in absorbance units (A)

$\epsilon$ =the wavelength-dependent molar absorptivity coefficient (units L/mol\*cm)

b=the pathlength (units cm)

c=the sample concentration (units mol/L)

The reference, or blank solution, generally is the buffer that the molecule of target is suspended or dissolved in. This solution should be the same pH and of a similar ionic strength as the sample solution.

### Blanking Cycle for Pedestal mode

It is recommended that the blanking reference is measured as a sample. This confirms that the instrument is working well and that no sample residue on the pedestal. To run a blanking cycle, perform the following:

1. Click “dsDNA” on the “nucleic acid” interface of the main to enter the measurement interface. Add 2ul of pure water to the pedestal with a pipette, put down the lid, click “Blank” and lift the lid up after the measurement. Clean the sample on the upper and lower pedestal with a dry airlaid paper.
2. Use a pipette to add 2ul of pure water to the pedestal, lower the lid, and click “Measure” on the display. At this time, a sample column will be made between the two fibers on the pedestal and the measurement will be started. Then lift the lid and wipe the sample on the upper and lower pedestal with a dry airlaid paper.
3. Repeat the second step of the pure water measurement step. After the measurement, save the data results, lift the lid, wipe the sample on the upper and lower pedestal with dry airlaid paper, and then lower the lid.
4. Observe the 10mm absorbance sampling curve on the display. The three measurement results should be the same horizontal line. The absorbance value should not exceed 0.04A. Although it is not necessary to blank between each sample, it is recommended that a new blank be taken every 30 minutes when measuring many samples.



## 2.6 Dye Editor

The software uses the general form of the Beer-Lambert equation to calculate fluorescent dye concentrations in the Micro Array and Proteins & Labels applications. The user can choose to enter new dye types using the Dye Editor. As shown in picture 2-7:

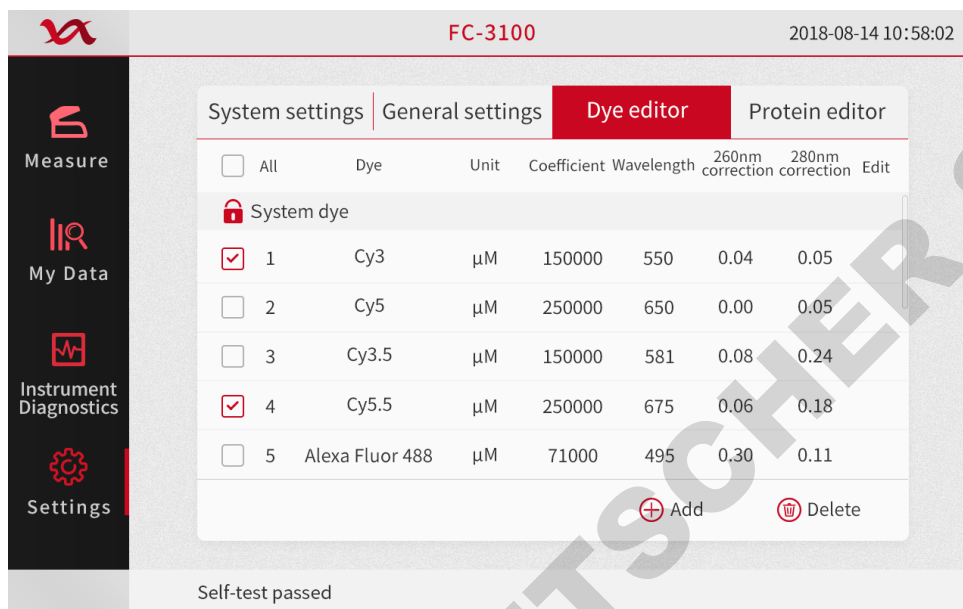



Picture 2-7

### 3 Software

#### 3.1 Software Upgrade

1. The software is upgraded through the USB flash drive. You need to create a folder "MUVT\_FILES" under the root directory of the USB flash drive. Create a folder "MUVT\_UPDATE" under the MUVT\_FILES folder, and put the upgrade file "MUVT.bin" and "MUVT.apk" into the folder.

(M:) > MUVT\_FILES > MUVT\_UPDATE

Name	Modified	Type	Size
 MUVT.apk	2019/1/14 11:30	APK 文件	17,398 KB
 MUVT.bin	2018/12/18 17:01	BIN 文件	154 KB

Picture 3-1

2. Insert the USB flash drive into the USB port and enter the setup page. As shown in Picture 3-2, click the "U disk upgrade".

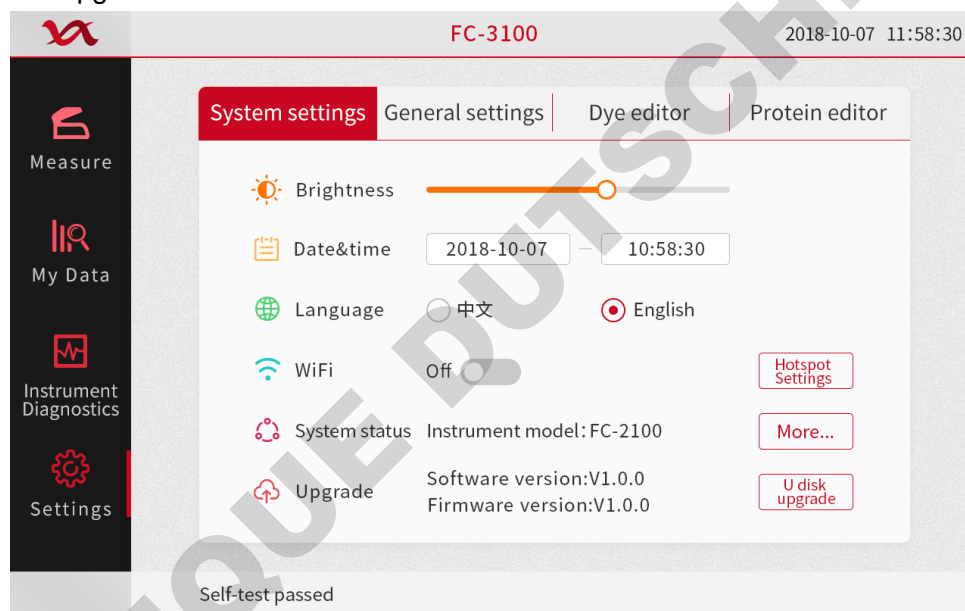

Picture 3-2

During the USB flash drive upgrade process, the following five situations may occur due to the integrity of the upgrade file:

- 1) Both "MUVT.bin" and "MUVT.apk" exist under the "MUVT\_UPDATE" folder on the USB disk. Only the "MUVT.bin" file is intact. The instrument will only upgrade the firmware "MUVT.bin". The dialog box shown in Picture 3-2-1 is "Upgrading, please wait..." After the firmware upgrade is completed, the dialog box shown in Picture 3-2-2, "Firmware update is successful, please restart the instrument." After restarting the instrument, the firmware upgrade is complete.

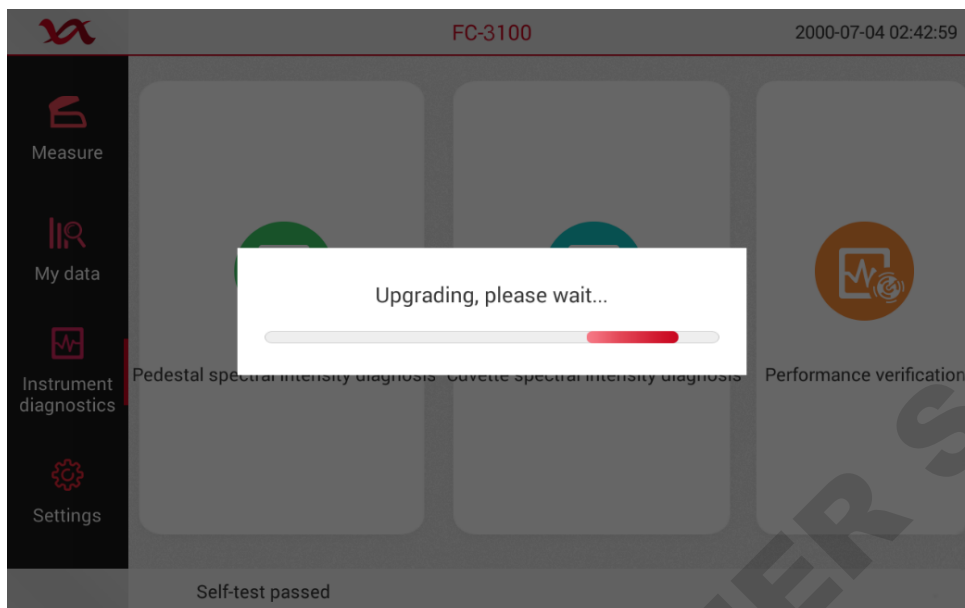

Picture 3-2-1

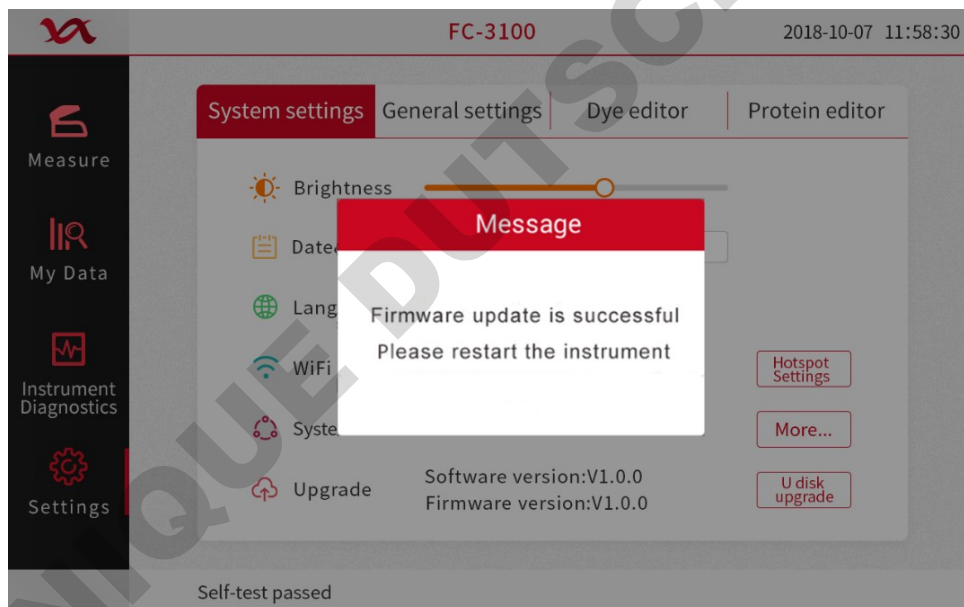

Picture 3-2-2

- 2) Both "MUVT.bin" and "MUVT.apk" exist in the USB disk folder "MUVT\_UPDATE". Only the "MUVT.apk" file is intact, the instrument will automatically upgrade the software "MUVT.apk". After the instrument screen goes out, it will light up and automatically jump to the main page. The dialog box shown in Picture 3-2-3 is displayed, "Software upgrade is successful. Please restart the instrument." Restart the instrument to complete the software upgrade.

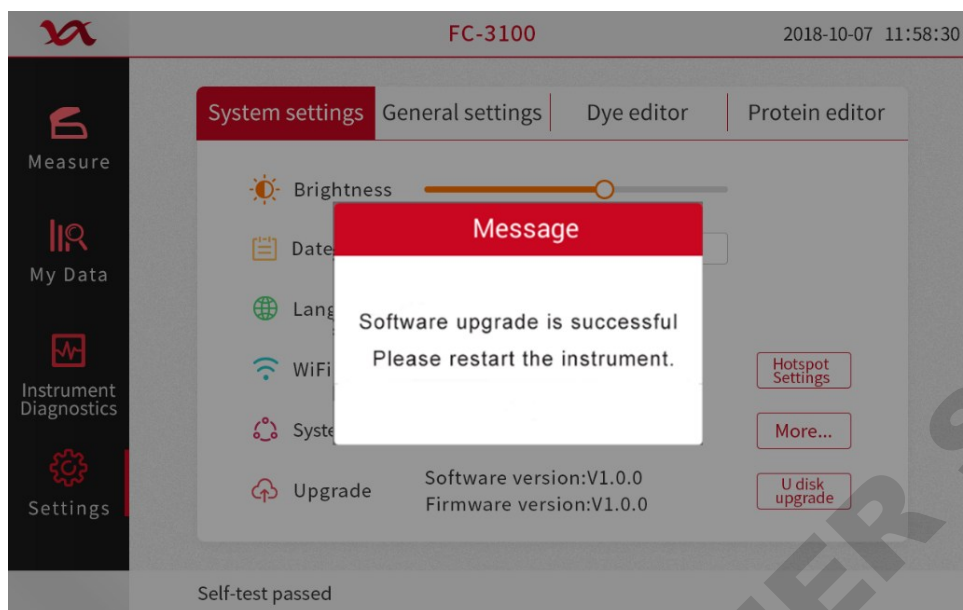

Picture 3-2-3

- 3) If both "MUVT.bin" and "MUVT.apk" in the USB disk folder "MUVT\_UPDATE" exist and both files are in good condition, the instrument will automatically upgrade the firmware and software.
- ① The instrument performs firmware upgrade firstly, and the upgrade progress bar appears on the screen as shown in Picture 3-2-1
  - ② After the firmware upgrade is completed, the instrument will emit three "beeps" and then enter the software upgrade state;
  - ③ After the screen of the instrument goes out and lights up and returns to the main page automatically, a dialog box as shown in Picture 3-2-4 appears, prompting the software "Upgrade is successful, please restart the instrument"
  - ④ Restart the instrument to complete the upgrade of the instrument firmware and software.

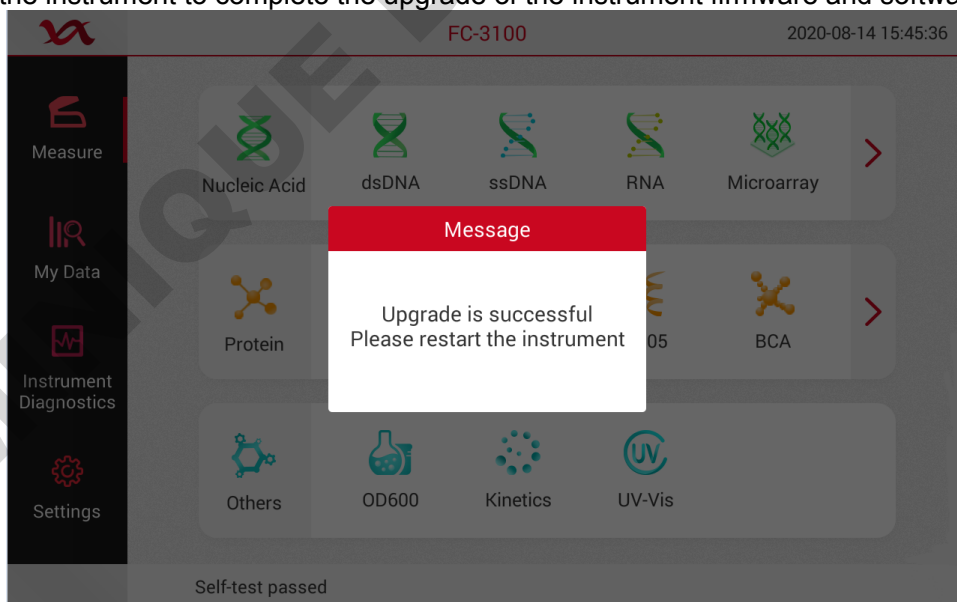

Picture 3-2-4

- 4) The files "MUVT.bin" and "MUVT.apk" under the file path "MUVT\_FILES> MUVT\_UPDATE" of the USB flash drive do not exist or the file names are wrong. The dialog box " Can't find the available installation package! " Will appear on the screen. , As shown in Picture 3-2-5.

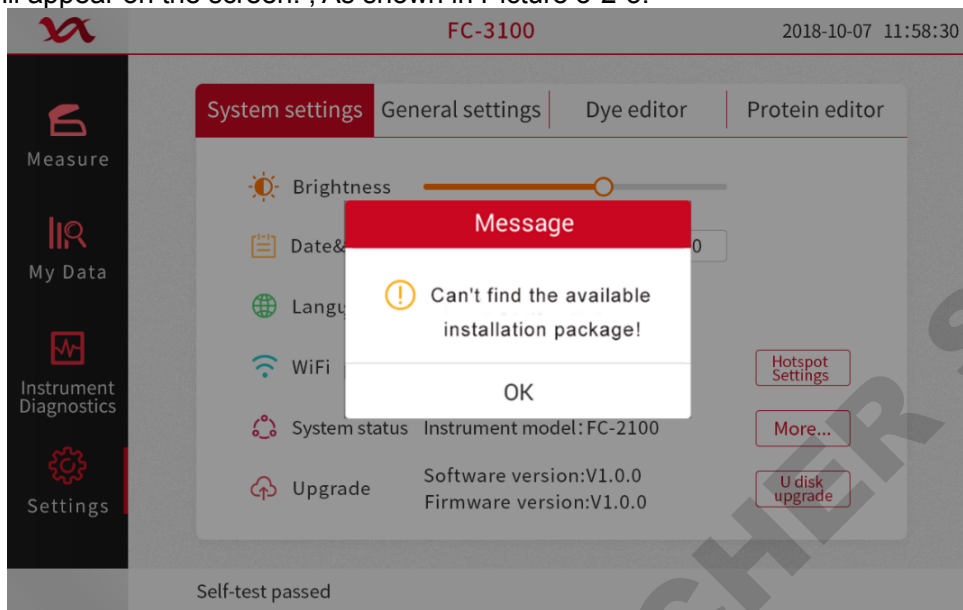

Picture 3-2-5

- 5) "MUVT.bin" and "MUVT.apk" exist under the USB disk folder "MUVT\_UPDATE", but both files are damaged, and a pop-up window "Unable to get the installation package information!" Will appear on the screen, as shown in Picture 3-2-6

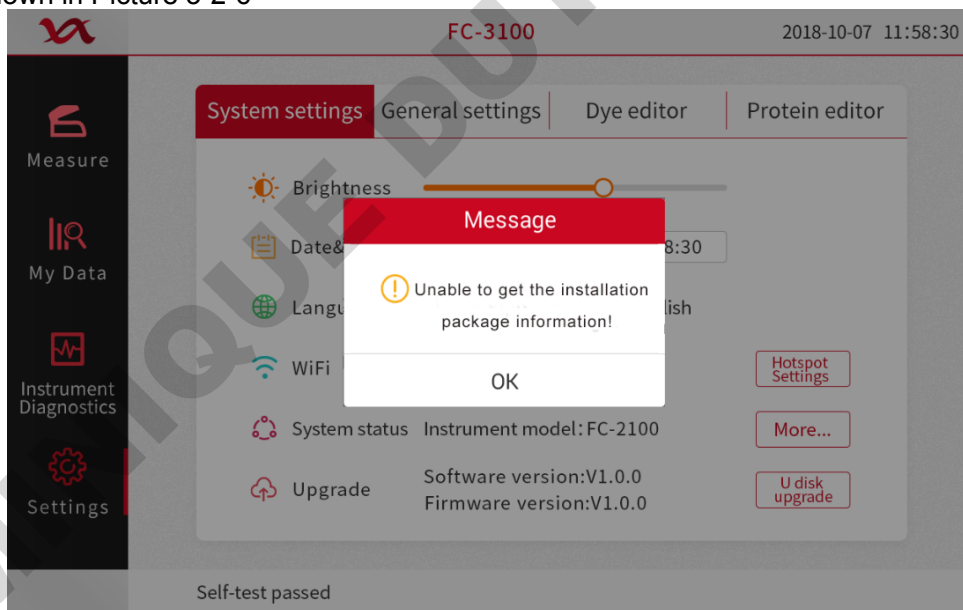

Picture 3-2-6

### 3.2 Software Features

The software starts, after power-on and flash ends, it enters the main interface, as shown in Picture 3-3, which mainly includes measurement types, my data, settings, system status, and instrument diagnosis.

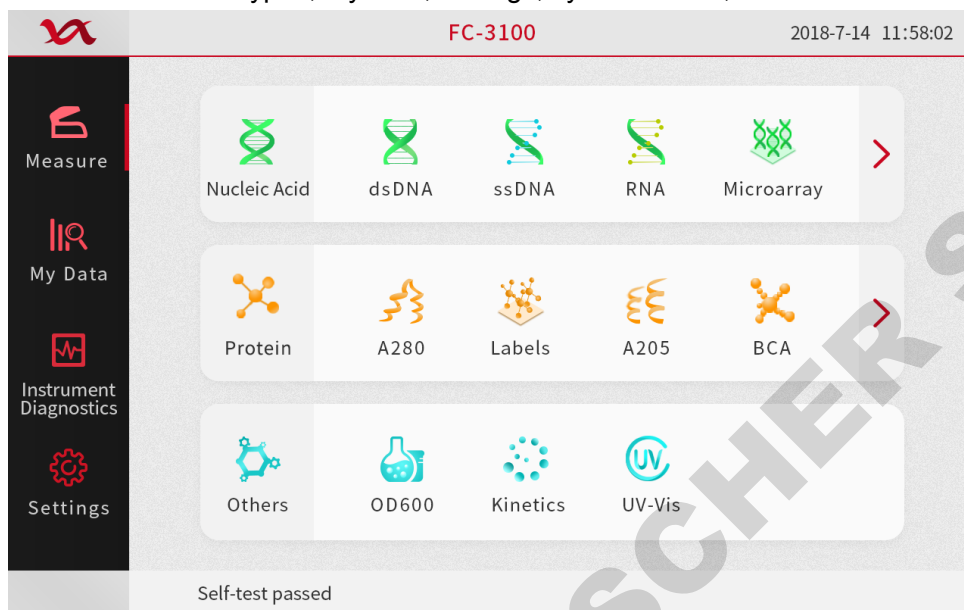

Picture 3-3

#### 3.2.1 Measurement Page

Nucleic acid, protein, and other, three main application categories are displayed on the left side of the sample detection interface. Sub-application categories are displayed after the main application. Click any category to enter the measurement page, as shown in Picture 3-4. It mainly includes menus, status bars, data windows, and function buttons.

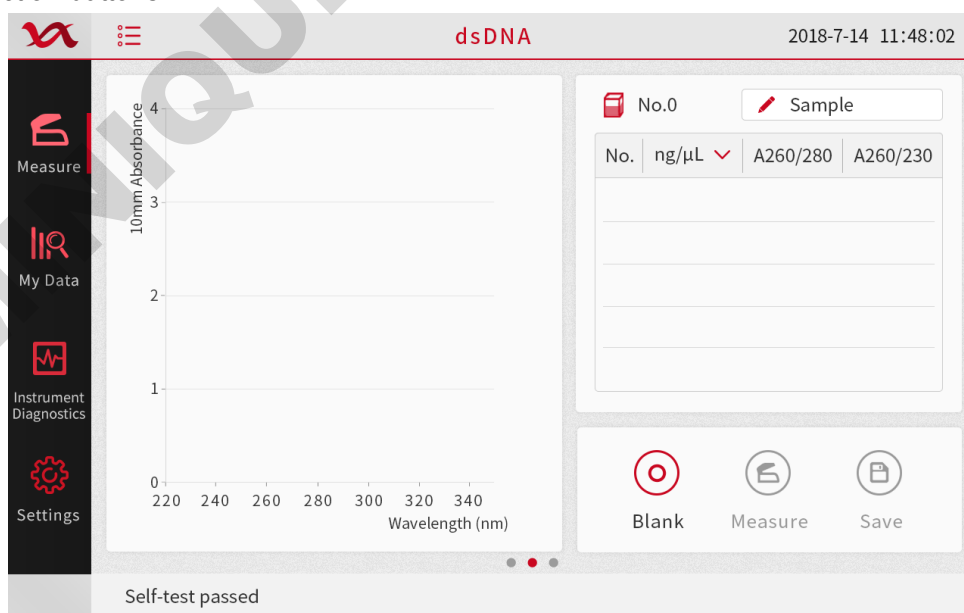

Picture 3-4

### 1. Menu

Menu is in the upper left corner, as shown as . Click the menu bar, as shown in Picture 3-5. Mainly used for parameter settings and export.

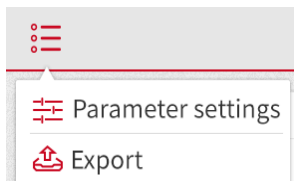

- 1) Parameter settings: Set the relevant parameters required for the measurement. Different measurement contents correspond to different parameter settings.
- 2) Export: Export the measurement data to a USB flash drive.



Picture 3-5

### 2. Status Bar

As shown in Picture 3-6, the status bar corresponds to the measurement name and current measurement times from left to right.



- 1) Measurement name: Located at the far left of the top status bar, it is used to display the name of the measurement when editing a single measurement, which can be edited. Click the name to edit the content. If the “Auto Naming” function is enabled in the settings (see “Settings” for details), each time you perform a measurement, it will be automatically named according to the rules of Sample1, Sample2, Sample3, and Sample4.
- 2) Measurement type: Located in the top status bar to show the category selection for the current experiment.
- 3) right icon  /  is to show pedestal/cuvette measurement
- 4) Measurement times: Located at the far right of the top status bar, it is used to display the current number of measurements.



Picture 3-6

### 3. Data window

The data window mainly includes a graph, a list of measurement results, and a list of details. The different measurement contents, chart coordinates and title will be different, the details are described in the “Instrument Function”.

Below the graph, the dots, as shown in picture , represent how many subpages are on the current page, and the solid dot indicates where the current page is. Picture  represent there are three subpages, currently on the first page. If there is a subpage before/after the current page, you can swipe left/right to switch pages. Switch to the second subpage as shown in Picture 3-7.

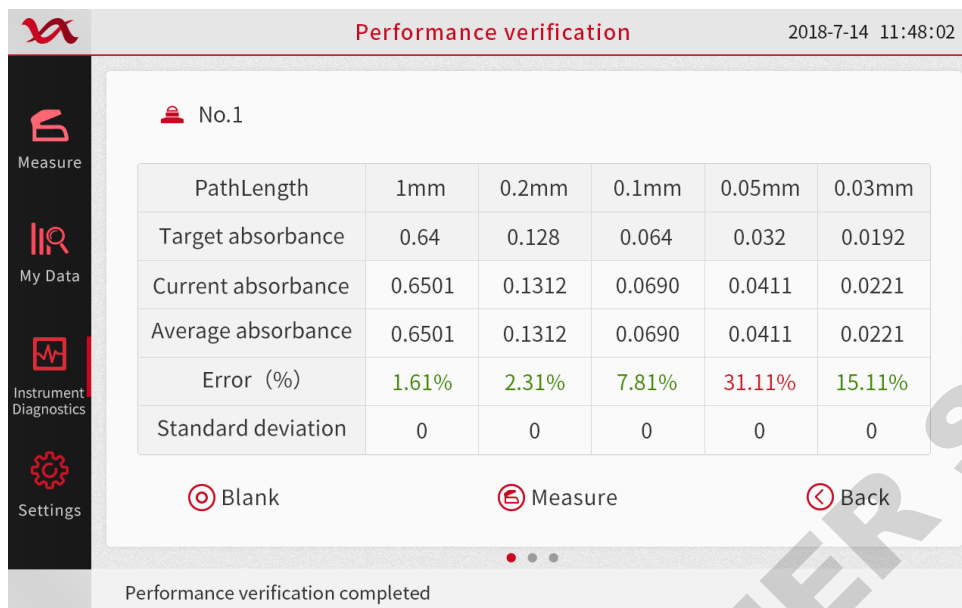

Picture 3-7

1) Graph: As shown in Picture 3-8, the sampling curve shows the spectrum of the newly measured sample, which can display the data results of multiple samples. The most recently measured sample curve is displayed after each measurement. Click to select the data list on the right, select a measurement, display the curve in the graph, and display up to 1 curves at the same time. When there is at least one curve in the graph, you can set the start and end wavelengths in the box on the right, and click "Show". The X-axis data of the graph will be changed to the values of the set start and end wavelengths. Set the display wavelength. After inputting, you can display the absorption value of the wavelength on the graph.

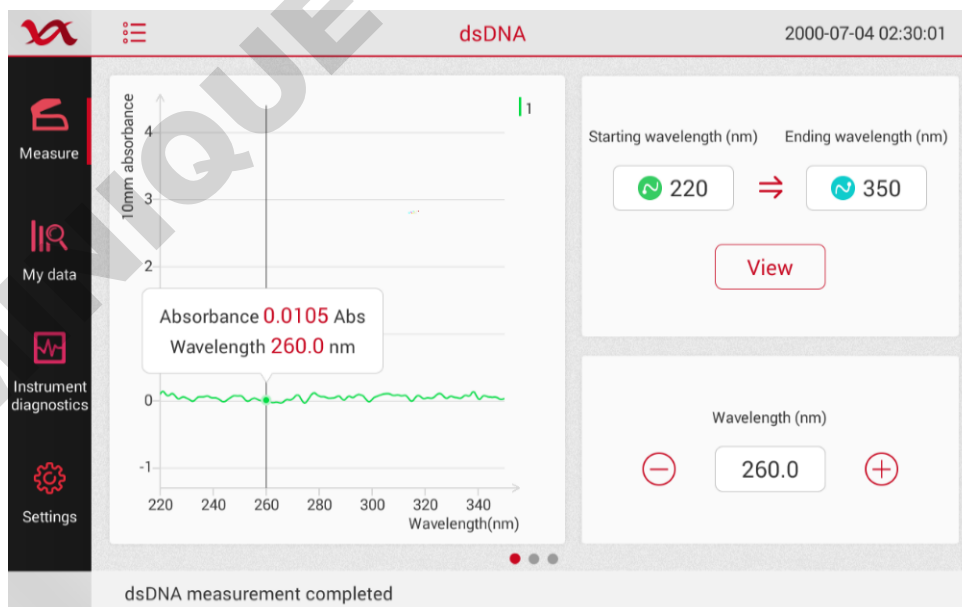

Picture 3-8

2) List of measure results: As shown in Picture 3-9, after the measurement is completed, the measurement result list is displayed on the right side of the data area (the list is hidden when no



measurement is performed). Click on a row in the list to select samples and update spectra, up to five spectra. Long press the row to view the corresponding data details. Click the selected row again to deselect it.

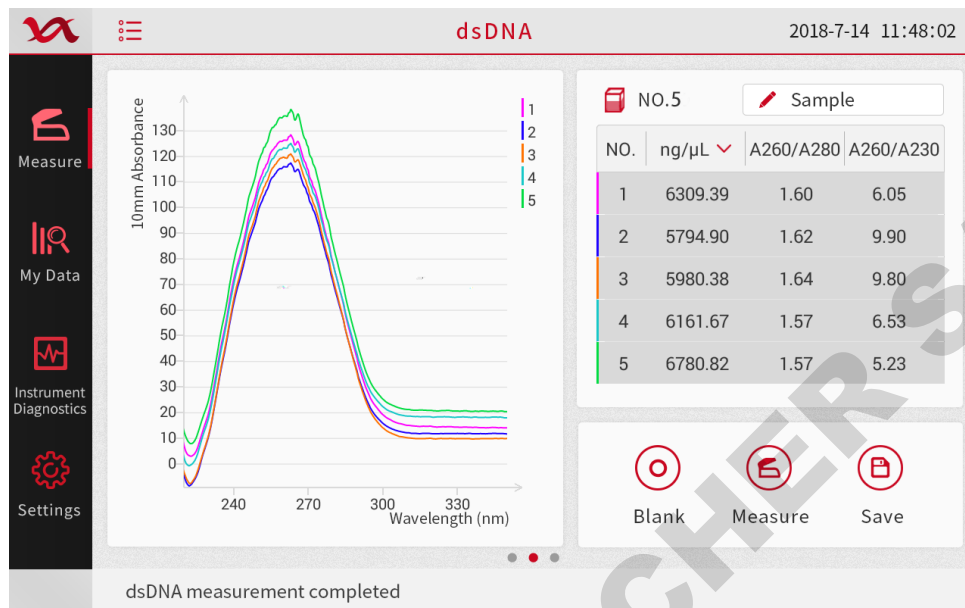

Picture 3-9

3) Details list: As shown in Picture 3-10, swipe the screen to the left to switch to the details list, click the icon ⓘ behind the row to enter the details page, as shown in Picture 3-11.

The screenshot shows the 'dsDNA' details list interface. The navigation menu is on the left. The main area displays a table with columns: 'NO.', 'Sample Name', 'ng/μL', 'A260/280', 'A260/230', and 'Details'. Each row has a red ⓘ icon in the 'Details' column. A status bar at the bottom indicates 'dsDNA measurement completed'.

NO.	Sample Name	ng/μL	A260/280	A260/230	Details
1	Sample	6309.39	1.60	6.05	ⓘ
2	Sample1	5794.90	1.62	9.90	ⓘ
3	Sample2	5980.38	1.64	9.80	ⓘ
4	Sample3	6161.67	1.57	6.53	ⓘ
5	Sample4	6780.82	1.57	5.23	ⓘ

Picture 3-10

4) Sample details page: As shown in Picture 3-11, the sample details page is used to display more measurement information. Click "OK" to return to the previous page, click "Delete" to delete the measurement.

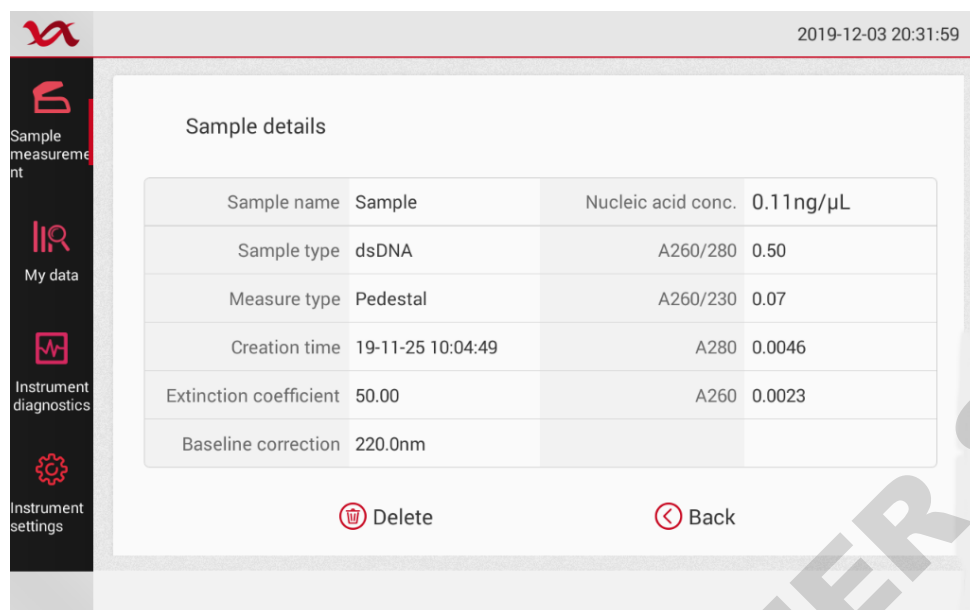

Picture 3-11

#### 4. Function button

The function button is divided into three buttons, as shown in Picture 3-12, which correspond to the four buttons “Blank”, “Measure”, “Save”, and “Home”.



Picture 3-12

- 1) Blank: Use a buffer that dissolves the sample to make a blank control. A blank control must be performed prior to sample measurement.
- 2) Measure: Start sample measurement. This function key is gray when it is just entering an application. It can only be used after a blank control. When in measurement, if it is not lidped and directly clicked, the software will prompts “Please add sample gain”. Turn on “Auto measure” in the settings page and the instrument will automatically start sample measurement after the lid is lowered.
- 3) Save: Save the current measurement result. The save button just entered is grayed out and cannot be clicked. It must be measured at least once before it can be used. No measurement data cannot be saved.

### 3.2.2 Parameter Settings

Different measurement types correspond to different parameter setting pages, and the specific page refers to the "application" module.

- 1) Baseline correction: The baseline is automatically set and the data for sample measurement is referenced to the baseline data. As shown in Picture 3-13, you can freely turn off the baseline correction function. Click to change the baseline correction value within the allowable range.
- 2) Extinction coefficient: When measuring nucleic acids and microarrays, it is necessary to select the type of sample to be measured, with the difference being the different extinction coefficients.
  - A . “dsDNA” corresponds to extinction coefficient of 50.

- B . “RNA” corresponds to extinction coefficient of 40.
- C . “ssDNA” corresponds to extinction coefficient of 33.
- D . When selecting “Oligo DNA”, “Oligo RNA” or “Custom”, you need to enter the corresponding extinction coefficient.

The screenshot shows a 'Settings' dialog box with a red header. The 'Sample type' is set to 'RNA'. The 'Extinction coefficients' field contains '50.00'. The 'Baseline correction' checkbox is checked, and the value '340.0' is entered in the adjacent field, with '(220-350nm)' written below it. At the bottom, there are 'Cancel' and 'OK' buttons.

Picture 3-13

- 3) Sample type: Set the sample type corresponding to the test as shown in Picture 3-14.
- 4) Dyes: Users can choose the preset dyes, or use the dye editing function to add new dyes.
- 5) Dye Slope Correction: In the correction of dye absorbance measurement, any offset caused by light scattering particles is obtained by subtracting the absorbance value of the slope from the 400 nm to 750 nm absorbance value at the dye analysis wavelength.
- 6) Absorbance Correction: The user-defined absorbance correction input is used to display the absorbance correction of the spectrogram by subtracting the absorbance correction value from the absorbance at all wavelengths in the sample spectrum.
- 7) Other measurement wavelengths: User-defined /custom wavelengths, if necessary, can be input to another wavelength for measurement.
- 8) Cell conversion factor  $10^8$ : User-defined factor. A recognized coefficient for measuring cell type, or empirically studying a solution of cells by using a known concentration of the same medium. The default value is  $1 \times 10^8$  which is a recognized factor for most bacterial cell suspensions such as E. coli.

The screenshot shows a 'Settings' dialog box with a red header. The 'Sample type' is set to 'dsDNA'. The 'Extinction coefficients' field contains '50.00' with '(15-150)' written below it. There are two 'Dye' fields, both set to 'None', each with a unit dropdown set to 'pmol/uL'. The 'Baseline correction' checkbox is checked, and the value '340.0' is entered in the adjacent field, with '(220-350nm)' written below it. At the bottom, there are 'Cancel' and 'OK' buttons.

Picture 3-14

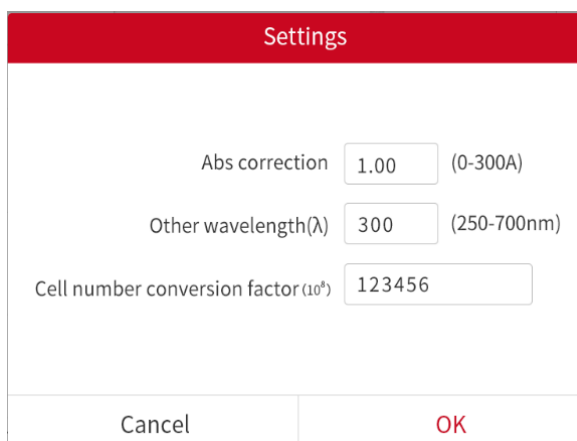

Picture 3-15

### 3.3 Software Measurement Example

Measure with dsDNA as an example

- 1. Start up** After the boot animation ends, enter the main window, as shown in Picture 3-3, click the “dsDNA” icon under the “Nucleic acid” column to enter the dsDNA measurement page, as shown in Picture 3-16.

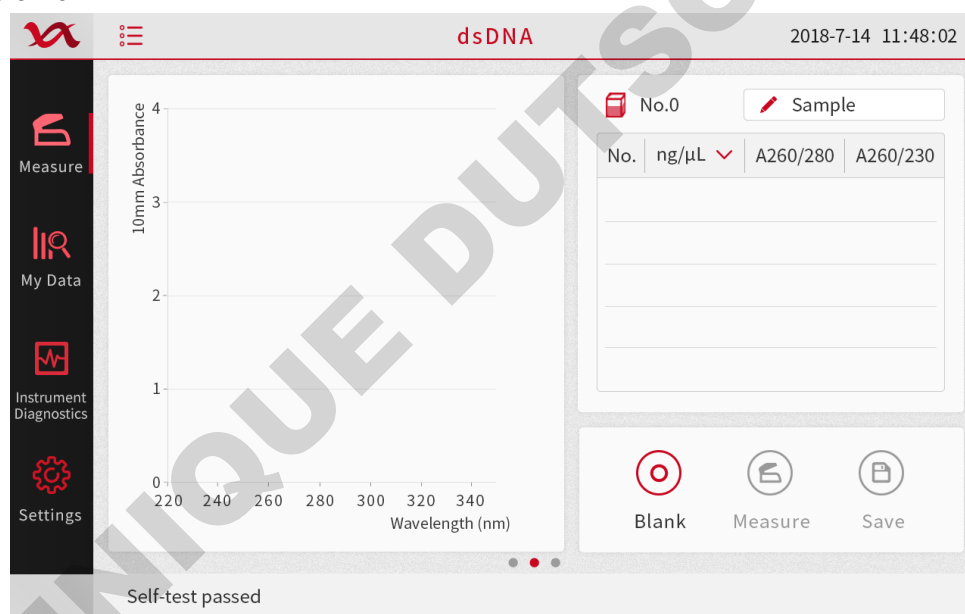

Picture 3-16

- 2. Blank** Open the instrument lid, wipe the pedestal fiber with a dry airlaid paper and add 1-2ul of pure water to the pedestal with a pipette (1 in Picture 2-4) and cover the lid. Click the icon  in the upper left corner of Picture 3-16 to bring up the interface shown in Picture 3-5. Click on the parameter settings in Picture 3-4, pop up the pop-up window shown in Picture 3-17, click on the baseline correction and enter the value of the corresponding sample. Click on the blank measurement in Picture 3-16 and the instrument will begin blank measurement.

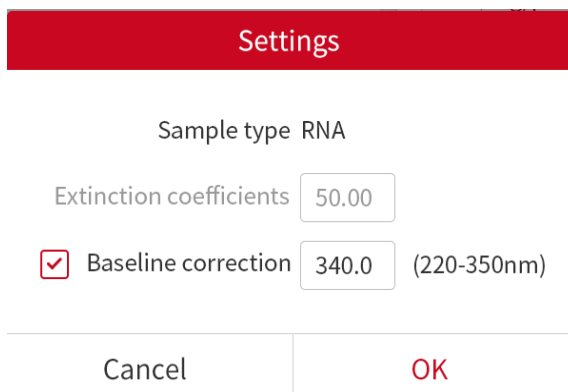

Picture 3-17

3. **Measure** After blank measurement, clean the upper and lower pedestal fibers with dry airlaid paper, and add the appropriate volume sample (depending on the actual sample measurement requirements) to the pedestal with the pipette and cover the lid. Click the “Measure” icon in Picture 3-16. After the measurement is completed, the corresponding curve will be generated. According to the steps, you can do 1-5 measurements as needed, and finally generate a list of measurement results, as shown in Picture 3-18.

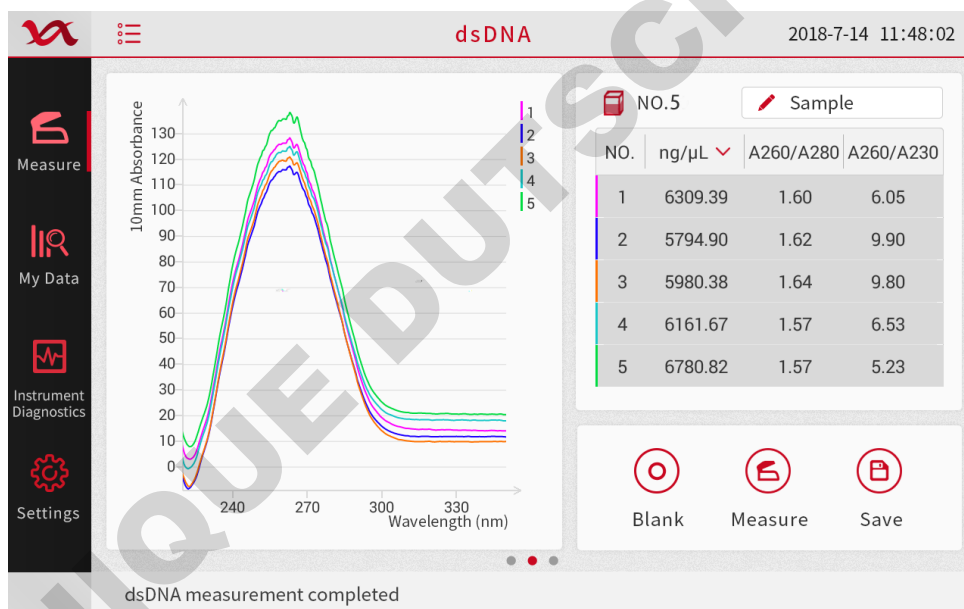

Picture 3-18

4. **Save** After the measurement is completed, click the “Save” icon to pop up the save window. In the pop-up window, enter the data name you want to save according to the actual input, and click OK. For other sample measurement, based on this step, data adjustments can be made according to specific requirements.

## 4 Application

### 4.1 Overview

This product can be easily used for UV-visible spectroscopic measurement using a small amount of sample:

1. The concentration of nucleic acid at a concentration of less than 27500 ng/μl (dsDNA, ssDNA, RNA) can be measured without dilution
2. Nucleic acid concentrations of "Oligo DNA" and "Oligo RNA"
3. Pure protein concentration measurement (A280, A205)
4. Measurement of fluorescent dye groups in Micro Array applications
5. Quantitative analysis of BCA protein
6. Bradford protein quantitative analysis
7. Lowry method protein quantitative analysis
8. Pierce 660nm protein quantitative analysis
9. Ordinary UV-visible spectrophotometric measurement
10. Kinetics measurement
11. OD600 microbial cell culture measurement

### 4.2 Measurement

1. Click on the icon to select the appropriate sample type.
2. Wipe the upper and lower pedestals with dry airlaid paper and make a blank measurement with a suitable liquid. The blank control liquid is the buffer that dissolves the target molecule. The pH and ion concentration of the blank control liquid should be the same as the measurement sample.

Pedestal mode: Add 1-2μl blank control to the pedestal, lower the lid, check the baseline correction, and click the blank.

Cuvette mode: When inserting a cuvette, note the direction of the arrow on the instrument. Please add liquid as recommended by the cuvette manufacturer.

---

**Note** For all mode measurement, the lid must be lowered. If the lid is not lowered, the instrument will prompt "Please close the lid" or "This experiment data is abnormal" in the middle of the interface. Before taking the pedestal measurement, remove the cuvette so that the lid is placed in the correct position.

---

3. Add the sample as the way of the blank, check the baseline correction, and click "Measure" button to start the measurement.

Pedestal mode: If "Auto measure" is turned on in "Settings", put down the lid and start measurement automatically. If "Auto measure" is set to "Off", lower the lid and click measure.

Cuvette mode: Click to measure.

---

**Note** Each sample measured must be new.

---

#### After the measurement is completed

Wipe the upper and lower pedestals with dry airlaid paper so the instrument can perform the next sample measurement.

When using a cuvette, remove the cuvette, thoroughly clean the cuvette and allow to dry.

## 5 Instrument function

### 5.1 dsDNA

#### 5.1.1 Overview

This product can be used to easily measure the concentration and quality of dsDNA. To measure dsDNA, select the dsDNA function on the main page. The dsDNA assay can show the absorbance of samples from 220 to 350 nm.

#### 5.1.2 dsDNA Concentration Calculation

For nucleic acid concentration, the Beer-Lambert equation is used:

$$C = (A * \epsilon) / b$$

C—the nucleic acid concentration in ng/ml

A—the absorbance in AU

$\epsilon$ —the wavelength-dependent extinction coefficient in ng-cm/ml

b—the pathlength in cm

The generally accepted extinction coefficients for dsDNA are:

ds DNA: 50ng-cm/ $\mu$ l

When the pedestal mode is selected, the instrument uses a short path length of 1.0 mm to 0.05 mm for measurement, and high concentration samples can be measured without dilution.

<b>Note</b>	Regardless of the pedestal measurement or cuvette measurement, the dsDNA measurement sampling curve uniformly displays the absorbance value of the current sample calibrated to a 10 mm path length.
-------------	--

The instrument can accurately measure dsDNA with a concentration of  $\leq 27500$ ng/ $\mu$ l without dilution. For each sample, the software automatically selects the best measurement path for measurement.

When the absorbance of the measurement sample is  $\geq 3.0$  (10 mm path length), a smaller amount of sample can be used for the measurement.

The sampling curve shows the absorbance of the current sample calibrated to a 10 mm path length.

#### The measurement results include the following:

**Sample Type**—The type of sample to be measured.

**Sample Name** — Enter the name of the sample before performing sample measurement.

**Measurement type** —Whether the measurement is a cuvette mode or a pedestal mode

**Creation time** — The system time at which the test was performed.

**Baseline Correction** —If baseline correction is selected, the default calibration wavelength is 340 nm and the user can enter different calibration wavelengths depending on the measurement. Under any measurements, the baseline is automatically set to the absorbance at the calibration wavelength. The reading at all wavelengths is subtracted from this value. If you do not select the baseline correction function, the baseline of the spectrum will shift and the calculated nucleic acid concentration will be higher than the true value.

**A260 (10mm pathlength)** — Shows the absorbance at 260nm in the 10mm pathlength.

**A280 (10 mm pathlength)** —Shows the absorbance at 280 nm in the 10 mm pathlength.

**260/280** —The ratio of absorbance at 260 nm and 280 nm, this value is used to determine purity. If this ratio is too small, it indicates the presence of protein, phenol or other contaminants that have significant light absorption at 280 nm.

**260/230** —The ratio of the absorbance at 260 nm and 230 nm, which is a secondary indicator of nucleic acid purity. This ratio of pure nucleic acids is greater than the ratio of 260/280. If the ratio is low, it indicates that there are contaminants in the nucleic acid.

**Concentration value** —The concentration value calculated by the absorbance at 260 nm and the extinction coefficient. The concentration unit can be selected in the drop-down box below.

---

**Note** If you do not select a baseline correction spectrum value will produce an offset, the calculated concentration will also change.

---

### 5.1.3 Nucleic acid Concentration Measurement

1. On the Home page, select the Nucleic Acid and click dsDNA.
2. The dsDNA extinction coefficient is 50
3. Select the concentration unit, the default is ng/μg.
4. Baseline correction can be selected. The default calibration wavelength is 340nm. You can also re-enter a calibration wavelength
5. Select Overlay to display the results of multiple measurement samples in the Sampling Curves box.
6. Wipe the upper and lower pedestals with dry airlaid paper and use a suitable liquid to create a blank control that will dissolve the target solution. The pH and ion concentration of the blank control liquid should be the same as the measurement sample.

Pedestal mode: Add a 1-2μl blank to the pedestal, lower the lid, and click the blank measurement button.

Cuvette mode: When inserting a cuvette, note the direction of the arrow on the instrument. Please add liquid as recommended by the cuvette manufacturer.

---

**Note** For all mode measurement, the lid must be lowered. If the lid is not lowered, the instrument will prompt “Please close the lid” in the middle of the interface. Before taking the pedestal measurement, remove the cuvette so that the lid is placed in the correct position.

---

7. Add the sample as you do the blank measurement, check the baseline correction, and click “Measure” to start the measurement.

Pedestal mode: If “Auto measure” is turned on in “Settings”, put down the lid and start measurement automatically. If “Auto measure” is set to “Off”, lower the lid and click measure.

Cuvette mode: Click to measure.

---

**Note** Each sample measured must be new.

---

#### After the measurement is completed

Wipe the upper and lower pedestals with dry airlaid paper so the instrument can perform the next sample measurement.

When using a cuvette, remove the cuvette, thoroughly clean the cuvette and allow to dry.



## 5.2 ssDNA

### 5.2.1 Overview

The instrument can be used to easily measure the concentration and quality of ssDNA. To measure ssDNA, select the ssDNA function on the main page. The ssDNA assay can show absorbance values for samples from 220 to 350 nm.

### 5.2.2 ssDNA Concentration Calculation

For ssDNA concentration, the Beer-Lambert equation is used:

$$C = (A * \epsilon) / b$$

C—the nucleic acid concentration in ng/ml

A—the absorbance in AU

$\epsilon$ —the wavelength-dependent extinction coefficient in ng-cm/ml

b—the pathlength in cm

The generally accepted extinction coefficients for ssDNA are:

ssDNA: 33ng-cm/ $\mu$ l

When the pedestal mode is selected, the instrument uses a short path length of 1.0 mm to 0.05 mm for measurement, and high concentration samples can be measured without dilution.

<b>Note</b>	Regardless of the pedestal measurement or cuvette measurement, the ssDNA measurement sampling curve uniformly displays the absorbance value of the current sample calibrated to a 10 mm path length.
-------------	--

The instrument can accurately measure ssDNA with a concentration of  $\leq 27500$ ng/ $\mu$ l without dilution. For each sample, the software automatically selects the best measurement path for measurement.

When the absorbance of the measurement sample is  $\geq 3.0$  (10 mm path length), a smaller amount of sample can be used for the measurement.

The sampling curve shows the absorbance of the current sample calibrated to a 10 mm path length.

#### The measurement results include the following:

**Sample Type**—The type of sample to be measured.

**Sample Name** — Enter the name of the sample before performing sample measurement.

**Measurement type** — Whether the measurement is a cuvette or a pedestal.

**Creation time** — The system time at which the test was performed.

**Baseline Correction** — If baseline correction is selected, the default calibration wavelength is 340 nm and the user can enter different calibration wavelengths depending on the measurement. Under any measurements, the baseline is automatically set to the absorbance at the calibration wavelength. The reading at all wavelengths is subtracted from this value. If you do not select the baseline correction function, the baseline of the spectrum will shift and the calculated nucleic acid concentration will be higher than the true value.

**A260 (10mm pathlength)** — Shows the absorbance at 260nm in the 10mm pathlength.

**A280 (10 mm pathlength)** — Shows the absorbance at 280 nm in the 10 mm pathlength.

**260/280** — The ratio of absorbance at 260 nm and 280 nm, this value is used to determine purity. If this ratio is too small, it indicates the presence of protein, phenol or other contaminants that have significant light absorption at 280 nm.

**260/230** — The ratio of the absorbance at 260 nm and 230 nm, which is a secondary indicator of nucleic acid purity. This ratio of pure nucleic acids is greater than the ratio of 260/280. If the ratio is low, it indicates that there are contaminants in the nucleic acid.

**Concentration value** — The concentration value calculated by the absorbance at 260 nm and the extinction coefficient. The concentration unit can be selected in the drop-down box below.

---

**Note** If you do not select a baseline correction spectrum value will produce an offset, the calculated concentration will also change.

---

### 5.2.3 Nucleic acid Concentration Measurement

1. On the Home page, select the Nucleic Acid and click ssDNA.
2. The ssDNA extinction coefficient is 33
3. Select the concentration unit, the default is ng/μg.
4. Baseline correction can be selected. The default calibration wavelength is 340nm. You can also re-enter a calibration wavelength.
5. Select Overlay to display the results of multiple measurement samples in the Sampling Curves box.
6. Wipe the upper and lower pedestals with dry airlaid paper and use a suitable liquid to create a blank control that will dissolve the target solution. The pH and ion concentration of the blank control liquid should be the same as the measurement sample.

Pedestal mode: Add a 1-2μl blank to the pedestal, lower the lid, and click the blank measurement button.

Cuvette mode: When inserting a cuvette, note the direction of the arrow on the instrument. Please add liquid as recommended by the cuvette manufacturer.

---

**Note** For all mode measurement, the lid must be lowered. If the lid is not lowered, the instrument will prompt “Please close the lid” in the middle of the interface. Before taking the pedestal measurement, remove the cuvette so that the lid is placed in the correct position.

---

7. Add the sample as it of blank, check the baseline correction, and click “Measure” to start the measurement.

Pedestal mode: If “Auto measure” is turned on in “Settings”, put down the lid and start measurement automatically. If “Auto measure” is set to “Off”, lower the lid and click measure.

Cuvette mode: Click to measure.

---

**Note** Each sample measured must be new.

---

### After the measurement is completed

Wipe the upper and lower pedestals with dry airlaid paper so the instrument can perform the next sample measurement.

When using a cuvette, remove the cuvette, thoroughly clean the cuvette and allow to dry.

## 5.3 RNA

### 5.3.1 Overview

The instrument can be used to easily measure the concentration and quality of RNA. To measure ssDNA, select the RNA function on the main page. The RNA assay can show absorbance values for samples from 220 to 350 nm.

### 5.3.2 RNA Concentration Calculation

For RNA concentration, the Beer-Lambert equation is used:

$$C = (A * \epsilon) / b$$

C—the nucleic acid concentration in ng/ml

A—the absorbance in AU

$\epsilon$ —the wavelength-dependent extinction coefficient in ng-cm/ml

b—the pathlength in cm

The generally accepted extinction coefficients for ssDNA are:

RNA: 40ng-cm/ $\mu$ l

When the pedestal mode is selected, the instrument uses a short path length of 1.0 mm to 0.05 mm for measurement, and high concentration samples can be measured without dilution.

<b>Note</b>	Regardless of the pedestal measurement or cuvette measurement, the ssDNA measurement sampling curve uniformly displays the absorbance value of the current sample calibrated to a 10 mm path length.
-------------	--

The instrument can accurately measure RNA with a concentration of  $\leq 27500$ ng/ $\mu$ l without dilution. For each sample, the software automatically selects the best measurement path for measurement.

When the absorbance of the measurement sample is  $\geq 3.0$  (10 mm path length), a smaller amount of sample can be used for the measurement.

The sampling curve shows the absorbance of the current sample calibrated to a 10 mm path length.

#### The measurement results include the following:

**Sample Type**—The type of sample to be measured.

**Sample Name** — Enter the name of the sample before performing sample measurement.

**Measurement type** — Whether the measurement is a cuvette or a pedestal.

**Creation time** — The system time at which the test was performed.

**Baseline Correction** — If baseline correction is selected, the default calibration wavelength is 340 nm and the user can enter different calibration wavelengths depending on the measurement. Under any measurements, the baseline is automatically set to the absorbance at the calibration wavelength. The reading at all wavelengths is subtracted from this value. If you do not select the baseline correction function, the baseline of the spectrum will shift and the calculated nucleic acid concentration will be higher than the true value.

**A260 (10mm pathlength)** — Shows the absorbance at 260nm in the 10mm pathlength.

**A280 (10 mm pathlength)** — Shows the absorbance at 280 nm in the 10 mm pathlength.

**260/280** — The ratio of absorbance at 260 nm and 280 nm, this value is used to determine purity. If this ratio is too small, it indicates the presence of protein, phenol or other contaminants that have significant light absorption at 280 nm.

**260/230** — The ratio of the absorbance at 260 nm and 230 nm, which is a secondary indicator of nucleic acid purity. This ratio of pure nucleic acids is greater than the ratio of 260/280. If the ratio is low, it indicates that there are contaminants in the nucleic acid.

**Concentration value** — The concentration value calculated by the absorbance at 260 nm and the extinction coefficient. The concentration unit can be selected in the drop-down box below.

---

**Note** If you do not select a baseline correction spectrum value will produce an offset, the calculated concentration will also change.

---

### 5.3.3 Nucleic acid Concentration Measurement

1. On the Home page, select the Nucleic Acid and click RNA.
2. The RNA extinction coefficient is 40
3. Select the concentration unit, the default is ng/ $\mu$ g.
4. Baseline correction can be selected. The default calibration wavelength is 340nm. You can also re-enter a calibration wavelength.
5. Select Overlay to display the results of multiple measurement samples in the Sampling Curves box.
6. Wipe the upper and lower pedestals with dry airlaid paper and use a suitable liquid to create a blank control that will dissolve the target solution. The pH and ion concentration of the blank control liquid should be the same as the measurement sample.

Pedestal mode: Add a 1-2 $\mu$ l blank to the pedestal, lower the lid, and click the blank measurement button.

Cuvette mode: When inserting a cuvette, note the direction of the arrow on the instrument. Please add liquid as recommended by the cuvette manufacturer.

---

**Note** For all mode measurement, the lid must be lowered. If the lid is not lowered, the instrument will prompt "Please close the lid" in the middle of the interface. Before taking the pedestal measurement, remove the cuvette so that the lid is placed in the correct position.

---

7. Add the sample as you do the blank measurement, check the baseline correction, and click "Measure" to start the measurement.  
Pedestal mode: If "Auto measure" is turned on in "Settings", put down the lid and start measurement automatically. If "Auto measure" is set to "Off", lower the lid and click measure.  
Cuvette mode: Click to measure.

---

**Note** Each sample measured must be new.

---

#### After the measurement is completed

Wipe the upper and lower pedestals with dry airlaid paper so the instrument can perform the next sample measurement.

When using a cuvette, remove the cuvette, thoroughly clean the cuvette and allow to dry.

## 5.4 Micro Array

### 5.4.1 Overview

Quantitative analysis of nucleic acids that have been labeled to use up to two fluorescent dyes is performed using a Micro Array application. The application reports nucleic acid concentration, A260/A280 ratio and concentration, and measured dye absorbance values, allowing measurement of dye concentrations as low as 0.2 picomoles per microliter.

### 5.4.2 Measurement Concentration Ranges

The instrument can accurately measure fluorescent dye-labeled nucleic acid concentrations up to 100 pmol/ $\mu$ l of Cy3 and 750 ng/ $\mu$ l of DNA.

The sampling curve shows the absorbance of the current sample calibrated to a 10 mm path length.

### 5.4.3 Dye Editor

The user can select a preset dye in the instrument software, or use the dye editing function to add a new dye. To add a new dye, select the dye editor in Settings and follow the dye manufacturer's instructions to fill in the appropriate calibration parameters. When a suitable dye is selected, a 260 nm calibration will be automatically applied to the nucleic acid concentration calculation. For detailed operation, please refer to the settings, dye editor. By default, dye 1 is Cy3 and dye 2 is Cy5.

**The measurement results include the following:**

**Sample Type**—The type of sample to be measured.

**Sample Name** — Enter the name of the sample before performing sample measurement.

**Measurement type** — Whether the measurement is a cuvette or a pedestal.

**Creation time** — The system time at which the test was performed.

**Baseline Correction** — If baseline correction is selected, the default calibration wavelength is 340 nm and the user can enter different calibration wavelengths depending on the measurement. Under any measurements, the baseline is automatically set to the absorbance at the calibration wavelength. The reading at all wavelengths is subtracted from this value. If you do not select the baseline correction function, the baseline of the spectrum will shift and the calculated nucleic acid concentration will be higher than the true value.

**Concentration value** — The concentration value calculated by the absorbance at 260 nm and the extinction coefficient. The concentration unit can be selected in the drop-down box below.

**A260** — Shows the absorbance at 260nm in the 10mm pathlength.

---

**Note** The A280 value shown is different from the absorbance of the sample at 280 nm (with a reference length of 750 nm). The A280 value takes into account the effect of the dye on the absorbance when calculating the protein concentration. The results are calibrated using the dye calibration factor. The absorbance calibration uses the selected calibration wavelength and the 750 nm baseline. Thus the displayed A280 value is not the same as the absorbance value used to calculate the protein concentration.

---

**260/280**—The ratio of absorbance at 260 and 280 nm. This ratio is used to determine the purity of

DNA and RNA. For DNA, a ratio of 1.8 is considered to be pure DNA, and for RNA, a ratio of 2.0 is considered to be pure RNA. If the ratio is low, it indicates the presence of protein, phenol or other light absorbing impurities at 280 nm in the nucleic acid.

**Dye Editor**—For dye selection, the default choices are: dye 1 (Cy3), dye 2 (Cy5).

**Dye 1 Concentration**—The concentration of dye 1 at the corresponding pathlength

**Dye 2 Concentration**—The concentration of dye 2 at the corresponding pathlength

**pmol/μl**—Based on the calculated concentration of the extinction coefficient of each fluorescent dye, the concentration unit can be selected in the drop-down box.

#### 5.4.4 Micro Array Measurement

1. On the Home page, select the Nucleic Acid and click
2. Select the type of sample to measure. The default setting is DNA and the extinction coefficient is 50.
3. Select the concentration unit, the default is ng/μg.
4. Use dye 1 or the drop-down box behind dye 2 to select the dye. The default dye settings are: dye 1 (Cy3), dye 2 (Cy5). If only one dye is labeled, select None on the dye 2 type.
5. Analytical calibration can be selected. The default calibration wavelength is 340nm. You can also re-enter a calibration wavelength.
6. Select Overlay to display the results of multiple measurement samples in the Sampling Curves box.
7. Wipe the upper and lower pedestals with dry airlaid paper and use a suitable liquid to create a blank control that will dissolve the target solution. The pH and ion concentration of the blank control liquid should be the same as the measurement sample.

Pedestal mode: Add a 1-2μl blank to the pedestal, lower the lid, and click the blank measurement button.

Cuvette mode: When inserting a cuvette, note the direction of the arrow on the instrument. Please add liquid as recommended by the cuvette manufacturer.

---

**Note** For all mode measurement, the lid must be lowered. If the lid is not lowered, the instrument will prompt “Please close the lid” in the middle of the interface. Before taking the pedestal measurement, remove the cuvette so that the lid is placed in the correct position.

---

8. Add the sample as if of blank, check the baseline correction, and click “Measure” to start the measurement.

Pedestal mode: If “Auto measure” is turned on in “Settings”, put down the lid and start measurement automatically. If “Auto measure” is set to “Off”, lower the lid and click measure.

Cuvette mode: Click to measure.

---

**Note** Each sample measured must be new.

---

#### After the measurement is completed

Wipe the upper and lower pedestals with dry airlaid paper so the instrument can perform the next sample measurement.

When using a cuvette, remove the cuvette, thoroughly clean the cuvette and allow to dry.

## 5.5 Oligo DNA

### 5.5.1 Overview

The concentration and quality of Oligo DNA can be easily measured using this instrument. To measure Oligo DNA, select the Oligo DNA function on the main page. The Oligo DNA measurement can show the absorbance of samples from 220 to 350 nm.

### 5.5.2 Oligo DNA Concentration Calculation

For Oligo DNA concentration, the Beer-Lambert equation is used:

$$C = (A * \epsilon) / b$$

C—the nucleic acid concentration in ng/ml

A—the absorbance in AU

$\epsilon$ —the wavelength-dependent extinction coefficient in ng-cm/ml

b—the pathlength in cm

The extinction coefficient of Oligo DNA is manually entered

When the pedestal mode is selected, the instrument uses a short path length of 1.0 mm to 0.05 mm for measurement, and high concentration samples can be measured without dilution.

<b>Note</b>	Regardless of the pedestal measurement or cuvette measurement, the Oligo DNA measurement sampling curve uniformly displays the absorbance value of the current sample calibrated to a 10 mm path length.
-------------	--

The instrument can accurately measure Oligo DNA with a concentration of  $\leq 27500$  ng/ $\mu$ l without dilution. For each sample, the software automatically selects the best measurement path for measurement.

When the absorbance of the measurement sample is  $\geq 3.0$  (10 mm path length), a smaller amount of sample can be used for the measurement.

The sampling curve shows the absorbance of the current sample calibrated to a 10 mm path length.

#### The measurement results include the following:

**Sample Type**—The type of sample to be measured.

**Sample Name** — Enter the name of the sample before performing sample measurement.

**Measurement type** — Whether the measurement is a cuvette or a pedestal.

**Creation time** — The system time at which the test was performed.

**Baseline Correction** — If baseline correction is selected, the default calibration wavelength is 340 nm and the user can enter different calibration wavelengths depending on the measurement. Under any measurements, the baseline is automatically set to the absorbance at the calibration wavelength. The reading at all wavelengths is subtracted from this value. If you do not select the baseline correction function, the baseline of the spectrum will shift and the calculated nucleic acid concentration will be higher than the true value.

**A260 (10mm pathlength)** — Shows the absorbance at 260nm in the 10mm pathlength.

**A280 (10 mm pathlength)** — Shows the absorbance at 280 nm in the 10 mm pathlength.

**260/280** — The ratio of absorbance at 260 nm and 280 nm, this value is used to determine purity. If

this ratio is too small, it indicates the presence of protein, phenol or other contaminants that have significant light absorption at 280 nm.

**260/230** — The ratio of the absorbance at 260 nm and 230 nm, which is a secondary indicator of nucleic acid purity. This ratio of pure nucleic acids is greater than the ratio of 260/280. If the ratio is low, it indicates that there are contaminants in the nucleic acid.

**Concentration value** — The concentration value calculated by the absorbance at 260 nm and the extinction coefficient. The concentration unit can be selected in the drop-down box below.

---

**Note** If you do not select a baseline correction spectrum value will produce an offset, the calculated concentration will also change.

---

### 5.5.3 Oligo DNA Concentration Measurement

1. On the Home page, select the Nucleic Acid and click Oligo DNA.
2. The extinction coefficient of Oligo DNA is manually entered.
3. Select the concentration unit, the default is ng/μg.
4. Baseline correction can be selected. The default calibration wavelength is 340nm. You can also re-enter a calibration wavelength.
5. Select Overlay to display the results of multiple measurement samples in the Sampling Curves box.
6. Wipe the upper and lower pedestals with dry airlaid paper and use a suitable liquid to create a blank control that will dissolve the target solution. The pH and ion concentration of the blank control liquid should be the same as the measurement sample.

Pedestal mode: Add a 1-2μl blank to the pedestal, lower the lid, and click the blank measurement button.

Cuvette mode: When inserting a cuvette, note the direction of the arrow on the instrument. Please add liquid as recommended by the cuvette manufacturer.

---

**Note** For all mode measurement, the lid must be lowered. If the lid is not lowered, the instrument will prompt "Please close the lid" in the middle of the interface. Before taking the pedestal measurement, remove the cuvette so that the lid is placed in the correct position.

---

7. Add the sample as you do the blank measurement, check the baseline correction, and click "Measure" to start the measurement.  
Pedestal mode: If "Auto measure" is turned on in "Settings", put down the lid and start measurement automatically. If "Auto measure" is set to "Off", lower the lid and click measure.  
Cuvette mode: Click to measure.

---

**Note** Each sample measured must be new.

---

#### After the measurement is completed

Wipe the upper and lower pedestals with dry airlaid paper so the instrument can perform the next sample measurement.

When using a cuvette, remove the cuvette, thoroughly clean the cuvette and allow to dry.



## 5.6 Oligo RNA

### 5.6.1 Overview

The concentration and quality of Oligo RNA can be easily measured using this instrument. To measure Oligo DNA, select the Oligo RNA function on the main page. The Oligo RNA measurement can show the absorbance of samples from 220 to 350 nm.

### 5.6.2 Oligo RNA Concentration Calculation

For Oligo RNA concentration, the Beer-Lambert equation is used:

$$C = (A * \epsilon) / b$$

C—the nucleic acid concentration in ng/ml

A—the absorbance in AU

$\epsilon$ —the wavelength-dependent extinction coefficient in ng-cm/ml

b—the pathlength in cm

The extinction coefficient of Oligo RNA is manually entered

When the pedestal mode is selected, the instrument uses a short path length of 1.0 mm to 0.05 mm for measurement, and high concentration samples can be measured without dilution.

---

**Note** Regardless of the pedestal measurement or cuvette measurement, the Oligo RNA measurement sampling curve uniformly displays the absorbance value of the current sample calibrated to a 10 mm path length.

---

The instrument can accurately measure Oligo RNA with a concentration of  $\leq 27500 \text{ ng}/\mu\text{l}$  without dilution. For each sample, the software automatically selects the best measurement path for measurement.

When the absorbance of the measurement sample is  $\geq 3.0$  (10 mm path length), a smaller amount of sample can be used for the measurement.

The sampling curve shows the absorbance of the current sample calibrated to a 10 mm path length.

#### The measurement results include the following:

**Sample Type**—The type of sample to be measured.

**Sample Name** — Enter the name of the sample before performing sample measurement.

**Measurement type** — Whether the measurement is a cuvette or a pedestal.

**Creation time** — The system time at which the test was performed.

**Baseline Correction** — If baseline correction is selected, the default calibration wavelength is 340 nm and the user can enter different calibration wavelengths depending on the measurement. Under any measurements, the baseline is automatically set to the absorbance at the calibration wavelength. The reading at all wavelengths is subtracted from this value. If you do not select the baseline correction function, the baseline of the spectrum will shift and the calculated nucleic acid concentration will be higher than the true value.

**A260 (10mm pathlength)** — Shows the absorbance at 260nm in the 10mm pathlength.

**A280 (10 mm pathlength)** — Shows the absorbance at 280 nm in the 10 mm pathlength.

**260/280** — The ratio of absorbance at 260 nm and 280 nm, this value is used to determine purity. If this ratio is too small, it indicates the presence of protein, phenol or other contaminants that have significant light absorption at 280 nm.

**260/230** — The ratio of the absorbance at 260 nm and 230 nm, which is a secondary indicator of nucleic acid purity. This ratio of pure nucleic acids is greater than the ratio of 260/280. If the ratio is low, it indicates that there are contaminants in the nucleic acid.

**Concentration value** — The concentration value calculated by the absorbance at 260 nm and the extinction coefficient. The concentration unit can be selected in the drop-down box below.

---

**Note** If you do not select a baseline correction spectrum value will produce an offset, the calculated concentration will also change.

---

### 5.6.3 Oligo RNA Concentration Measurement

1. On the Home page, select the Nucleic Acid and click Oligo RNA.
2. The extinction coefficient of Oligo RNA is manually entered.
3. Select the concentration unit, the default is ng/μg.
4. Baseline correction can be selected. The default calibration wavelength is 340nm. You can also re-enter a calibration wavelength.
5. Select Overlay to display the results of multiple measurement samples in the Sampling Curves box.
6. Wipe the upper and lower pedestals with dry airlaid paper and use a suitable liquid to create a blank control that will dissolve the target solution. The pH and ion concentration of the blank control liquid should be the same as the measurement sample.

Pedestal mode: Add a 1-2μl blank to the pedestal, lower the lid, and click the blank measurement button.

Cuvette mode: When inserting a cuvette, note the direction of the arrow on the instrument. Please add liquid as recommended by the cuvette manufacturer.

---

**Note** For all mode measurement, the lid must be lowered. If the lid is not lowered, the instrument will prompt "Please close the lid" in the middle of the interface. Before taking the pedestal measurement, remove the cuvette so that the lid is placed in the correct position.

---

7. Add the sample as you do the blank measurement, check the baseline correction, and click "Measure" to start the measurement.  
Pedestal mode: If "Auto measure" is turned on in "Settings", put down the lid and start measurement automatically. If "Auto measure" is set to "Off", lower the lid and click measure.  
Cuvette mode: Click to measure.

---

**Note** Each sample measured must be new.

---

#### After the measurement is completed

Wipe the upper and lower pedestals with dry airlaid paper so the instrument can perform the next sample measurement.

When using a cuvette, remove the cuvette, thoroughly clean the cuvette and allow to dry.

## 5.7 Custom

### 5.7.1 Overview

The instrument can be used to easily measure the concentration and quality of custom nucleic acids. To measure custom nucleic acids, select Custom on the main. Custom measurement can show the absorbance of samples from 220 to 350 nm. The custom function measures the nucleic acid concentration with a custom extinction coefficient.

### 5.7.2 Custom Concentration Calculation

For custom nucleic acid concentration, the Beer-Lambert equation is used:

$$C = (A * \epsilon) / b$$

C—the nucleic acid concentration in ng/ml

A—the absorbance in AU

$\epsilon$ —the wavelength-dependent extinction coefficient in ng-cm/ml

b—the pathlength in cm

The extinction coefficient of custom nucleic acid is manually entered

When the pedestal mode is selected, the instrument uses a short path length of 1.0 mm to 0.05 mm for measurement, and high concentration samples can be measured without dilution.

---

**Note** Regardless of the pedestal measurement or cuvette measurement, the Oligo RNA measurement sampling curve uniformly displays the absorbance value of the current sample calibrated to a 10 mm path length.

---

The instrument can accurately measure custom nucleic acid with a concentration of  $\leq 27500$  ng/ $\mu$ l without dilution. For each sample, the software automatically selects the best measurement path for measurement.

When the absorbance of the measurement sample is  $\geq 3.0$  (10 mm path length), a smaller amount of sample can be used for the measurement.

The sampling curve shows the absorbance of the current sample calibrated to a 10 mm path length.

**The measurement results include the following:**

**Sample Type**—The type of sample to be measured.

**Sample Name** — Enter the name of the sample before performing sample measurement.

**Measurement type** — Whether the measurement is a cuvette or a pedestal.

**Creation time** — The system time at which the test was performed.

**Baseline Correction** — If baseline correction is selected, the default calibration wavelength is 340 nm and the user can enter different calibration wavelengths depending on the measurement. Under any measurements, the baseline is automatically set to the absorbance at the calibration wavelength. The reading at all wavelengths is subtracted from this value. If you do not select the baseline correction function, the baseline of the spectrum will shift and the calculated nucleic acid concentration will be higher than the true value.

**A260 (10mm pathlength)** — Shows the absorbance at 260nm in the 10mm pathlength.

**A280 (10 mm pathlength)** — Shows the absorbance at 280 nm in the 10 mm pathlength.

**260/280** — The ratio of absorbance at 260 nm and 280 nm, this value is used to determine purity. If

this ratio is too small, it indicates the presence of protein, phenol or other contaminants that have significant light absorption at 280 nm.

**260/230** — The ratio of the absorbance at 260 nm and 230 nm, which is a secondary indicator of nucleic acid purity. This ratio of pure nucleic acids is greater than the ratio of 260/280. If the ratio is low, it indicates that there are contaminants in the nucleic acid.

**Concentration value** — The concentration value calculated by the absorbance at 260 nm and the extinction coefficient. The concentration unit can be selected in the drop-down box below.

---

**Note** If you do not select a baseline correction spectrum value will produce an offset, the calculated concentration will also change.

---

### 5.7.3 Custom Nucleic Acid Concentration Measurement

1. On the Home page, select the Nucleic Acid and click custom.
2. The extinction coefficient of custom nucleic acid is manually entered.
3. Select the concentration unit, the default is ng/μg.
4. Baseline correction can be selected. The default calibration wavelength is 340nm. You can also re-enter a calibration wavelength.
5. Select Overlay to display the results of multiple measurement samples in the Sampling Curves box.
6. Wipe the upper and lower pedestals with dry airlaid paper and use a suitable liquid to create a blank control that will dissolve the target solution. The pH and ion concentration of the blank control liquid should be the same as the measurement sample.

Pedestal mode: Add a 1-2μl blank to the pedestal, lower the lid, and click the blank measurement button.

Cuvette mode: When inserting a cuvette, note the direction of the arrow on the instrument. Please add liquid as recommended by the cuvette manufacturer.

---

**Note** For all mode measurement, the lid must be lowered. If the lid is not lowered, the instrument will prompt "Please close the lid" in the middle of the interface. Before taking the pedestal measurement, remove the cuvette so that the lid is placed in the correct position.

---

7. Add the sample as you do the blank measurement, check the baseline correction, and click "Measure" to start the measurement.  
Pedestal mode: If "Auto measure" is turned on in "Settings", put down the lid and start measurement automatically. If "Auto measure" is set to "Off", lower the lid and click measure.  
Cuvette mode: Click to measure.

---

**Note** Each sample measured must be new.

---

#### After the measurement is completed

Wipe the upper and lower pedestals with dry airlaid paper so the instrument can perform the next sample measurement.

When using a cuvette, remove the cuvette, thoroughly clean the cuvette and allow to dry.

## 5.8 Protein A280

### 5.8.1 Overview

Proteins are highly diverse, and the A280 function is mainly used to measure pure proteins containing Trp, Tyr residues or Cys-Cys disulfide bonds, which have higher absorbance at 280 nm. This method does not require the construction of a standard curve. After measuring the absorbance, the software directly calculates the protein concentration. As with nucleic acid measurement, the A280 spectrum shows data for a 10 mm pathlength.

Note: If the sample contains major peptide bonds and little or no amino acids, use Protein A205 instead of Protein A280.

### 5.8.2 Measurement Concentration Range

The instrument can measure up to 400 mg/ml of BSA in pedestal mode without dilution. The software can automatically use different pathlength to measure the absorbance of each sample.

Small volume measurement can be selected when the sample has a 10 mm absorbance value  $> 3.0$  ( $> 4.5$  mg/ml BSA).

The sampling curve shows the absorbance of the current sample calibrated to a 10 mm pathlength.

#### The measurement results include the following:

**Sample Name** — Enter the name of the sample before performing sample measurement.

**Measurement type** — Whether the measurement is a cuvette or a pedestal.

**Creation time** — The system time at which the test was performed.

**Type** — Six preset samples are available for protein analysis and concentration calculations. These choices can be made in the drop down box next to the type. The default is 1Abs = 1 mg / ml.

**Table 5-1 Protein A280 measurement type option**

1Abs = 1mg/ml	The absorbance of 1 mg/ml protein at 280 nm was 1 A.
BSA	The protein concentration was calculated using the mass extinction coefficient with reference to calf serum albumin: a mass extinction coefficient of 6.7 at 280 nm for the protein of 10 mg/ml.
IgG	The protein concentration was calculated using the mass extinction coefficient with reference to IgG: the mass extinction coefficient of the protein at 10 mg/ml at 280 nm was 13.7.
Lysozyme	With reference to lysozyme, the protein concentration was calculated using the mass extinction coefficient: the mass extinction coefficient of the protein at 10 mg/ml at 280 nm was 26.4.
( $\epsilon$ +MW)	Users can enter the molar extinction coefficient themselves as a reference for protein measurement.
( $\epsilon$ 1%)	The user can enter the mass extinction coefficient as a reference for 10 mg/ml protein measurement.

**Concentration value**—The concentration value calculated from the absorbance of the protein at 280 nm and the selected extinction coefficient. The concentration unit can be selected from the drop down box next to it. The default unit is mg/ml.

**A280 (10mm pathlength)** —Shows the absorbance at 280 nm in the 10 mm pathlength.

**260/280**—The ratio of absorbance at 260 nm and 280 nm

**Baseline Correction** — If baseline correction is selected, the default calibration wavelength is 340 nm and the user can enter different calibration wavelengths depending on the measurement. Under any measurements, the baseline is automatically set to the absorbance at the calibration wavelength. The reading at all wavelengths is subtracted from this value. If you do not select the baseline correction function, the baseline of the spectrum will shift and the calculated nucleic acid concentration will be higher than the true value.

### 5.8.3 Protein A280 Measurement

1. On the Home page, select the Protein tab and click A280.
2. Click on the menu and select parameter settings.
3. Select the type of measurement sample. The default setting is 1Abs=1mg/ml.
4. The concentration unit can be selected. The default unit is mg/ml.
5. Baseline correction can be selected. The default calibration wavelength is 340nm. You can also re-enter a calibration wavelength.
6. Select Overlay to display the experimental results for multiple test samples in the Sampling Curves box.
7. Wipe the upper and lower pedestals with dry airlaid paper and use a suitable liquid to create a blank control that will dissolve the target solution. The pH and ion concentration of the blank control liquid should be the same as the measurement sample.

Pedestal mode: Add a 1-2 $\mu$ l blank to the pedestal, lower the lid, and click the blank measurement button.

Cuvette mode: When inserting a cuvette, note the direction of the arrow on the instrument. The beam (2mm wide) is located 8.5mm above the bottom of the cuvette. Please add liquid as recommended by the cuvette manufacturer.

---

**Note** For all mode measurement, the lid must be lowered. If the lid is not lowered, the instrument will prompt “Please close the lid” in the middle of the interface. Before taking the pedestal measurement, remove the cuvette so that the lid is placed in the correct position.

---

8. Add the sample as you do the blank measurement, check the baseline correction, and click “Measure” to start the measurement.  
Pedestal mode: If “Auto measure” is turned on in “Settings”, put down the lid and start measurement automatically. If “Auto measure” is set to “Off”, lower the lid and click measure.  
Cuvette mode: Click to measure.

---

**Note** Each sample measured must be new.

---

#### After the measurement is completed

Wipe the upper and lower pedestals with dry airlaid paper so the instrument can perform the next sample measurement.

When using a cuvette, remove the cuvette, thoroughly clean the cuvette and allow to dry.

## 5.9 Protein&labels

### 5.9.1 Overview

Protein&labels applications are used to quantitatively analyze proteins and fluorescent dyes for protein conjugate arrays, as well as metalloproteins such as hemoglobin, using wavelength ratios. This application reports the protein concentration measured at 280 nm and the measured dye absorbance value, allowing measurement of dye concentrations as low as 0.2 picomoles per microliter. This information is particularly useful for assessing protein/dye binding (degree of labeling) for downstream applications.

### 5.9.2 Measurement Concentration Range

The instrument can accurately measure the fluorescent dye-labeled protein concentration up to 100 pmol/ul of Cy3

The sampling curve shows the absorbance of the current sample calibrated to a 10 mm path length.

### 5.9.3 Dye Editor

The user can select a preset dye in the instrument software, or use the dye editing function to add a new dye. To add a new dye, select the dye editor in Settings and follow the dye manufacturer's instructions to fill in the appropriate calibration parameters. When a suitable dye is selected, a 280 nm calibration will be automatically applied to the protein concentration calculation. For detailed operation, please refer to the settings, dye editor. By default, dye 1 is Cy3 and dye 2 is Cy5.

**The measurement results include the following:**

**Sample Type**—The type of sample to be measured.

**Sample Name** — Enter the name of the sample before performing sample measurement.

**Measurement type** — Whether the measurement is a cuvette or a pedestal.

**Creation time** — The system time at which the test was performed.

**Baseline Correction** — If baseline correction is selected, the default calibration wavelength is 340 nm and the user can enter different calibration wavelengths depending on the measurement. Under any measurements, the baseline is automatically set to the absorbance at the calibration wavelength. The reading at all wavelengths is subtracted from this value. If you do not select the baseline correction function, the baseline of the spectrum will shift and the calculated nucleic acid concentration will be higher than the true value.

**Concentration value**—The concentration value calculated from the absorbance of the protein at 280 nm and the selected extinction coefficient. The concentration unit can be selected from the drop down box next to it. The default unit is mg/ml.

**Dye Editor**—For dye selection, the default choices are: dye 1 (Cy3), dye 2 (Cy5).

**Dye 1 Concentration**—The concentration of dye 1 at the corresponding pathlength

**Dye 2 Concentration**—The concentration of dye 2 at the corresponding pathlength

**pmol/μl**—Based on the calculated concentration of the extinction coefficient of each fluorescent dye, the concentration unit can be selected in the drop-down box.

**Dye Slope Correction**—Corrects dye absorbance measurement because any absorbance caused by light scattering particles is subtracted from the absorbance of the slope at 400% to 750 nm at the dye analysis wavelength.

**Note** For all visible light measurement, the software is calibrated to a wavelength of 750 nm and the dye concentration is automatically calculated at 400 nm and 750 nm absorbance values.

---

### 5.9.4 Protein&labels Measurement

1. Select the Protein tab on the Home page and click on the Protein&labels.
2. Click on the menu and select parameter settings.
3. Select the type of measurement sample. The default setting is 1Abs=1mg/ml and the mass extinction coefficient is 10.
4. The concentration unit can be selected. The default unit is mg/ml.
5. Use dye 1 or the drop-down box behind dye 2 to select the dye. The default dye settings are: dye 1 (Cy3), dye 2 (Cy5). If only one dye is labeled, select None on the dye 2 type.
6. Analytical calibration can be selected. The default calibration wavelength is 340nm. You can also re-enter a calibration wavelength.
7. Select Overlay to display the experimental results of multiple test samples in the Sampling Curves box.
8. Wipe the upper and lower pedestals with dry airlaid paper and use a suitable liquid to create a blank control that will dissolve the target solution. The pH and ion concentration of the blank control liquid should be the same as the measurement sample.  
Pedestal mode: Add a 1-2 $\mu$ l blank to the pedestal, lower the lid, and click the blank measurement button.  
Cuvette mode: When inserting a cuvette, note the direction of the arrow on the instrument. Please add liquid as recommended by the cuvette manufacturer.

---

**Note** For all mode measurement, the lid must be lowered. If the lid is not lowered, the instrument will prompt "Please close the lid" in the middle of the interface. Before taking the pedestal measurement, remove the cuvette so that the lid is placed in the correct position.

---

9. Add the sample as you do the blank measurement, check the baseline correction, and click "Measure" to start the measurement.  
Pedestal mode: If "Auto measure" is turned on in "Settings", put down the lid and start measurement automatically. If "Auto measure" is set to "Off", lower the lid and click measure.  
Cuvette mode: Click to measure.

---

**Note** Each sample measured must be new.

---

#### After the measurement is completed

Wipe the upper and lower pedestals with dry airlaid paper so the instrument can perform the next sample measurement.

When using a cuvette, remove the cuvette, thoroughly clean the cuvette and allow to dry.



## 5.10 Protein A205

### 5.10.1 Overview

Other proteins purifying the peptide and 1 peptide bond were quantitatively analyzed using Protein A205, where absorbance was shown at 205 nm. This application reports protein concentration and two absorbance values (A205 and A280). You can also use a single point baseline correction

Note: If the sample contains major amino acids such as tryptophan and tyrosine, or cysteine-cysteine disulfide bonds, use protein A280 instead of protein A205

### 5.10.2 Measurement Concentration Range

The instrument can measure up to 400 mg/ml of BSA in pedestal mode without dilution. The software can automatically use different pathlength to measure the absorbance of each sample.

Small volume measurement can be selected when the sample has a 10 mm absorbance value > 3.0 (> 4.5 mg/ml BSA).

The sampling curve shows the absorbance of the current sample calibrated to a 10 mm pathlength.

**The measurement results include the following:**

**Sample Name** — Enter the name of the sample before performing sample measurement.

**Measurement type** — Whether the measurement is a cuvette or a pedestal.

**Creation time** — The system time at which the test was performed.

**Type** — Six preset samples are available for protein analysis and concentration calculations. These choices can be made in the drop down box next to the type. The default is 1Abs = 1 mg / ml.

**Table 5-2 Protein A205 measurement type option**

31	$\epsilon 0.1\%$ (1mg/ml) at 205nm=31
Range	$\epsilon 0.1\%$ (1mg/ml) at 205nm=27+120*(A280/A205)
( $\epsilon 1\%$ )	User-defined input extinction coefficient

**Concentration value**—The concentration value calculated from the absorbance of the protein at 280 nm and the selected extinction coefficient. The concentration unit can be selected from the drop down box next to it. The default unit is mg/ml.

**A205 (10mm pathlength)** —Shows the absorbance at 205 nm in the 10 mm pathlength.

**A280 (10mm pathlength)** —Shows the absorbance at 280 nm in the 10 mm pathlength.

**Baseline Correction** — If baseline correction is selected, the default calibration wavelength is 340 nm and the user can enter different calibration wavelengths depending on the measurement. Under any measurements, the baseline is automatically set to the absorbance at the calibration wavelength. The reading at all wavelengths is subtracted from this value. If you do not select the baseline correction function, the baseline of the spectrum will shift and the calculated nucleic acid concentration will be higher than the true value.

### 5.10.3 Protein A205 Measurement

1. On the Home page, select the Protein tab and click A205.
2. Click on the menu and select parameter settings.
3. Select the type of measurement sample. The default setting is 31.
4. The concentration unit can be selected. The default unit is mg/ml.
5. Baseline correction can be selected. The default calibration wavelength is 340nm. You can also re-enter a calibration wavelength.
6. Select Overlay to display the experimental results for multiple test samples in the Sampling Curves box.
7. Wipe the upper and lower pedestals with dry airlaid paper and use a suitable liquid to create a blank control that will dissolve the target solution. The pH and ion concentration of the blank control liquid should be the same as the measurement sample.

Pedestal mode: Add a 1-2 $\mu$ l blank to the pedestal, lower the lid, and click the blank measurement button.

Cuvette mode: When inserting a cuvette, note the direction of the arrow on the instrument. The beam (2mm wide) is located 8.5mm above the bottom of the cuvette. Please add liquid as recommended by the cuvette manufacturer.

---

**Note** For all mode measurement, the lid must be lowered. If the lid is not lowered, the instrument will prompt "Please close the lid" in the middle of the interface. Before taking the pedestal measurement, remove the cuvette so that the lid is placed in the correct position.

---

8. Add the sample as you do the blank measurement, check the baseline correction, and click "Measure" to start the measurement.  
Pedestal mode: If "Auto measure" is turned on in "Settings", put down the lid and start measurement automatically. If "Auto measure" is set to "Off", lower the lid and click measure.  
Cuvette mode: Click to measure.

---

**Note** Each sample measured must be new.

---

#### After the measurement is completed

Wipe the upper and lower pedestals with dry airlaid paper so the instrument can perform the next sample measurement.

When using a cuvette, remove the cuvette, thoroughly clean the cuvette and allow to dry.

## 5.11 Protein BCA

### 5.11.1 Overview

BCA is a method for measuring the concentration of non-pure protein by colorimetry, which is commonly used for the measurement of diluted protein concentrations, as well as for the measurement of concentrations of proteins containing light-absorbing impurities in the ultraviolet region. The BCA method requires the construction of a standard curve before protein quantification.

The BCA method is a method for measuring Cu+1 ions, and in an alkaline environment, Cu+2 ions are reduced to Cu+1 ions by proteins. Two biquinoline dicarboxylic acid BCA molecules and one Cu+1 ion form a purple chelate. In the presence of protein, the absorbance at a wavelength of 750 nm is the baseline, and the chelate formed by Cu-BCA has a maximum absorbance at 562 nm.

### 5.11.2 BCA Measurement Range

**The commercial BCA kit has two protein measurement ranges:**

The conventional assay uses a reagent/protein sample volume ratio of 20:1 and a measurement concentration ranging from 0.20 mg/ml to 8.0 mg/ml (BSA). When using pedestal measuring, a 4  $\mu$ l sample and 80  $\mu$ l of BCA reagent are recommended.

The micro-measurement uses a reagent/sample volume ratio of 1:1 and can measure protein concentrations ranging from 0.01 mg/ml to 0.20 mg/ml. To prepare enough samples for pedestal measuring, it is recommended to use 10  $\mu$ l of sample and 10  $\mu$ l of BCA reagent (using a PCR tube).

Prepare standards and build standard curves according to the manufacturer's instructions. Ensure that the processing time and ambient temperature of each sample are consistent throughout all measuring procedures.

The sampling curve shows the absorbance of the current sample calibrated to a 10 mm path length.

**The measurement results include the following:**

**Sample Name** — Enter the name of the sample before performing sample measurement.

**Measurement type** — Whether the measurement is a cuvette or a pedestal.

**Creation time** — The system time at which the test was performed.

**Concentration** — The concentration unit of the current sample.

**Absorbance value (562nm)** — The absorbance of the complex at 562 nm.

**Curve type** — Displays the type of curve of the current standard curve, including discrete, linear, multi-order equations, etc. The default selection is linear.

**Repeat times** — Enter the reference product or the number of times the same standard or averaged sample is measured, resulting in a concentration value associated with it.

**Standard** — Enter the actual concentration value for each standard.

**R<sup>2</sup>** — Indicates the extent to which the standard curve fits the standard data points (1.0 indicates perfect fit; all points are on the curve).

---

<b>Note</b>	The state of the effective curve simply indicates that the number of samples tested has met the minimum sample point required for the standard curve. The standard curve state does not indicate the fit of the standard curve. To include a wider range of detection concentrations, a larger number of standard points are required.
-------------	--

---

### 5.11.3 BCA Standard Curve Line

A simplest standard curve can consist of two points, including two standard points. The standard curve can include up to 7 standard points, and there is no order requirement for testing each standard point.

The standard point can only be added to the standard curve at the time of sample measurement. When the first sample is started, the standard point cannot be added to the standard curve.

---

**Note** If a previously saved experimental record is selected, the concentration calculations for all samples are based on the standard curve in the experimental record. Only one standard curve can be saved for each experimental record.

---

### 5.11.4 Perform BCA Measurement

Prepare the sample with reference to the reagent manufacturer's instructions.

The zero reference standard is operated at the same sample/reagent ratio as the other standards and samples, except that there is no protein inside.

Prepare standards and samples according to the manufacturer's instructions. The blank used should be the same as the standard, the pH and salt concentration of the sample.

The concentration range of the standard should cover the concentration range of the full sample.

**Operation process:**

1. On the Home page, select the Protein tab and click on Protein BCA.
2. By entering the concentration of each standard in the parameter settings, the software can measure up to 7 standards. Standard points can be measured multiple times.

---

**Note** The standard curve requires a minimum of 2 standard points. It is recommended to measure multiple standards. The concentration range of the standard should cover the concentration range of the sample. For this analysis, the recommended setting is "Linear"

---

3. Wipe the upper and lower pedestals with dry airlaid paper and use a suitable liquid to create a blank control that will dissolve the target solution. The pH and ion concentration of the blank control liquid should be the same as the measurement sample.

Pedestal mode: Add a 1-2 $\mu$ l blank to the pedestal, lower the lid, and click the blank measurement button.

Cuvette mode: When inserting a cuvette, note the direction of the arrow on the instrument. The beam (2mm wide) is located 8.5mm above the bottom of the cuvette. Please add liquid as recommended by the cuvette manufacturer.

---

**Note** For all mode measurement, the lid must be lowered. If the lid is not lowered, the instrument will prompt "Please close the lid" in the middle of the interface. Before taking the pedestal measurement, remove the cuvette so that the lid is placed in the correct position.

---

4. Select a standard point, add the corresponding standard as the above blank measurement, click the measurement button to start the measurement, and then do the sample measurement after all the standard points are measured. If the "Repeat" setting is greater than 1, repeat the measurement.
5. After the standard point measurement is completed, a prompt box will pop up to confirm whether to continue adding the standard. After the standard is not added, enter the sample measurement mode.

Add the 2µl sample to the measurement base as described above, and click the measurement. The button starts to measure the sample. There is no need to perform a blank measurement between the test standard and the sample.

Pedestal mode: If “Auto measure” is turned on in “Settings”, put down the lid and start measurement automatically. If “Auto measure” is set to “Off”, lower the lid and click measure.

Cuvette mode: Click to measure.

---

**Note** Each sample measured must be new.

---

### After the measurement is completed

Wipe the upper and lower pedestals with dry airlaid paper so the instrument can perform the next sample measurement.

When using a cuvette, remove the cuvette, thoroughly clean the cuvette and allow to dry.

## 5.12 Protein Bradford

### 5.12.1 Overview

Bradford is a commonly used method for quantitative protein measurement. It is commonly used for the measurement of concentrations of proteins at lower concentrations. As with other colorimetric methods, the Bradford method must construct a standard curve when measuring protein concentration.

The Bradford method is based on the protein in an acidic solution, which enables Coomassie Brilliant Blue to bind, so that the maximum absorption peak of the dye is changed to 595 nm to measure the protein concentration. The absorbance of the protein-dye complex at 595 nm was measured and baseline corrected at 750 nm, and the protein concentration was calculated. The reagents used in the measurement can be purchased from multiple manufacturers.

### 5.12.2 Bradford Measurement Range

#### **The commercial Bradford kit has two protein measurement ranges:**

The conventional assay uses a reagent/protein sample in a volume ratio of 50:1 and a measurement concentration ranging from 0.10 mg/ml to 8.0 mg/ml (BSA) with an optimal linear concentration ranging from 0.01 to 1 mg/ml. When using pedestal measuring, a 4µl sample and 200µl Bradford reagent are recommended.

The micro-measurement uses a reagent/sample volume ratio of 1:1 and can measure protein concentrations ranging from 15 µg/ml to 125 µg/ml. To prepare enough samples for pedestal measuring, it is recommended to use 10µl of sample and 10µl of Bradford reagent (using a PCR tube).

Prepare standards and build standard curves according to the manufacturer's instructions. Ensure that the processing time and ambient temperature of each sample are consistent throughout all measuring procedures.

The sampling curve shows the absorbance of the current sample calibrated to a 10 mm pathlength.

#### **The measurement results include the following:**

**Sample Name** — Enter the name of the sample before performing sample measurement.

**Measurement type** — Whether the measurement is a cuvette or a pedestal.

**Creation time** — The system time at which the test was performed.

**Concentration**—The concentration unit of the current sample.

**Absorbance value (562nm)** —The absorbance of the complex at 562 nm.

**Curve type**—Displays the type of curve of the current standard curve, including discrete, linear, multi-order equations, etc. The default selection is linear.

**Repeat times**—Enter the reference product or the number of times the same standard or averaged sample is measured, resulting in a concentration value associated with it.

**Standard**—Enter the actual concentration value for each standard.

**R<sup>2</sup>**—Indicates the extent to which the standard curve fits the standard data points (1.0 indicates perfect fit; all points are on the curve).

---

**Note** The state of the effective curve simply indicates that the number of samples tested has met the minimum sample point required for the standard curve. The standard curve state does not indicate the fit of the standard curve. To include a wider range of detection concentrations, a larger number of standard points are required.

---

### 5.12.3 Bradford Standard Curve Line

A simplest standard curve can consist of two points, including two standard points. The standard curve can include up to 7 standard points, and there is no order requirement for testing each standard point.

The standard point can only be added to the standard curve at the time of sample measurement. When the first sample is started, the standard point cannot be added to the standard curve.

---

**Note** If a previously saved experimental record is selected, the concentration calculations for all samples are based on the standard curve in the experimental record. Only one standard curve can be saved for each experimental record.

---

### 5.12.4 Perform Bradford Measurement

Prepare the sample with reference to the reagent manufacturer's instructions.

The zero reference standard is operated at the same sample/reagent ratio as the other standards and samples, except that there is no protein inside.

Prepare standards and samples according to the manufacturer's instructions. The blank used should be the same as the standard, the pH and salt concentration of the sample.

The concentration range of the standard should cover the concentration range of the full sample.

**Operation process:**

1. On the Home page, select the Protein tab and click on Protein Bradford.
2. By entering the concentration of each standard in the parameter settings, the software can measure up to 7 standards. Standard points can be measured multiple times.

---

**Note** The standard curve requires a minimum of 2 standard points. It is recommended to measure multiple standards. The concentration range of the standard should cover the concentration range of the sample. For this analysis, the recommended setting is "Linear"

---

3. Wipe the upper and lower pedestals with dry airlaid paper and use a suitable liquid to create a blank control that will dissolve the target solution. The pH and ion concentration of the blank control liquid should be the same as the measurement sample.

Pedestal mode: Add a 1-2 $\mu$ l blank to the pedestal, lower the lid, and click the blank measurement button.

Cuvette mode: When inserting a cuvette, note the direction of the arrow on the instrument. The beam (2mm wide) is located 8.5mm above the bottom of the cuvette. Please add liquid as recommended by the cuvette manufacturer.

---

**Note** For all mode measurement, the lid must be lowered. If the lid is not lowered, the instrument will prompt "Please close the lid" in the middle of the interface. Before taking the pedestal measurement, remove the cuvette so that the lid is placed in the correct position.

---

4. Select a standard point, add the corresponding standard as the above blank measurement, click the measurement button to start the measurement, and then do the sample measurement after all the standard points are measured. If the "Repeat" setting is greater than 1, repeat the measurement.
5. After the standard point measurement is completed, a prompt box will pop up to confirm whether to continue adding the standard. After the standard is not added, enter the sample measurement mode. Add the 2 $\mu$ l sample to the measurement base as described above, and click the measurement. The button starts to measure the sample. There is no need to perform a blank measurement between the test standard and the sample.

Pedestal mode: If "Auto measure" is turned on in "Settings", put down the lid and start measurement automatically. If "Auto measure" is set to "Off", lower the lid and click measure.

Cuvette mode: Click to measure.

---

**Note** Each sample measured must be new.

---

#### **After the measurement is completed**

Wipe the upper and lower pedestals with dry airlaid paper so the instrument can perform the next sample measurement.

When using a cuvette, remove the cuvette, thoroughly clean the cuvette and allow to dry.

## **5.13 Protein Lowry**

### **5.13.1 Overview**

The Lowry method is a reaction between a protein and copper sulfate in an alkaline environment to form a copper-protein complex. The Folin-Ciocalteu reagent effectively reduces the copper complex and produces a blue product proportional to the amount of protein. The absorbance of the blue product at 650 nm was measured and baseline corrected at 405 nm, and the protein concentration was calculated. The reagents used in the measurement can be purchased from multiple manufacturers. As with other colorimetric methods, the Lowry method also requires the construction of a standard curve before protein quantification.

### **5.13.2 Lowry Measurement Range**

It is recommended to use 20 $\mu$ l of protein sample and 100 $\mu$ l of Lowry reagent for reaction. The concentration of the sample that can be measured on the instrument ranges from 0.20 mg/ml to 4 mg/ml.

Prepare standards and build standard curves according to the manufacturer's instructions. Ensure that the processing time and ambient temperature of each sample are consistent throughout all measuring procedures. Protein standards (BSA) used to construct standard curves can be purchased from kit manufacturers.

The sampling curve shows the absorbance of the current sample calibrated to a 10 mm pathlength.

**The measurement results include the following:**

**Sample Name** — Enter the name of the sample before performing sample measurement.

**Measurement type** — Whether the measurement is a cuvette or a pedestal.

**Creation time** — The system time at which the test was performed.

**Concentration** — The concentration unit of the current sample.

**Absorbance value (650nm)** — The absorbance of the complex at 650 nm.

**Curve type** — Displays the type of curve of the current standard curve, including discrete, linear, multi-order equations, etc. The default selection is linear.

**Repeat times** — Enter the reference product or the number of times the same standard or averaged sample is measured, resulting in a concentration value associated with it.

**Standard** — Enter the actual concentration value for each standard.

**R<sup>2</sup>** — Indicates the extent to which the standard curve fits the standard data points (1.0 indicates perfect fit; all points are on the curve).

---

**Note** The state of the effective curve simply indicates that the number of samples tested has met the minimum sample point required for the standard curve. The standard curve state does not indicate the fit of the standard curve. To include a wider range of detection concentrations, a larger number of standard points are required.

---

### 5.13.3 Lowry Standard Curve Line

A simplest standard curve can consist of two points, including two standard points. The standard curve can include up to 7 standard points, and there is no order requirement for testing each standard point.

The standard point can only be added to the standard curve at the time of sample measurement. When the first sample is started, the standard point cannot be added to the standard curve.

---

**Note** If a previously saved experimental record is selected, the concentration calculations for all samples are based on the standard curve in the experimental record. Only one standard curve can be saved for each experimental record.

---

### 5.13.4 Perform Lowry Measurement

Prepare the sample with reference to the reagent manufacturer's instructions.

The zero reference standard is operated at the same sample/reagent ratio as the other standards and samples, except that there is no protein inside.

Prepare standards and samples according to the manufacturer's instructions. The blank used should be the same as the standard, the pH and salt concentration of the sample.

The concentration range of the standard should cover the concentration range of the full sample.

**Operation process:**

1. On the Home page, select Protein and click on Protein Lowry.
2. By entering the concentration of each standard in the parameter settings, the software can measure up to 7 standards. Standard points can be measured multiple times.



**Note** The standard curve requires a minimum of 2 standard points. It is recommended to measure multiple standards. The concentration range of the standard should cover the concentration range of the sample. For this analysis, the recommended setting is "Linear"

---

3. Wipe the upper and lower pedestals with dry airlaid paper and use a suitable liquid to create a blank control that will dissolve the target solution. The pH and ion concentration of the blank control liquid should be the same as the measurement sample.

Pedestal mode: Add a 1-2 $\mu$ l blank to the pedestal, lower the lid, and click the blank measurement button.

Cuvette mode: When inserting a cuvette, note the direction of the arrow on the instrument. The beam (2mm wide) is located 8.5mm above the bottom of the cuvette. Please add liquid as recommended by the cuvette manufacturer.

---

**Note** For all mode measurement, the lid must be lowered. If the lid is not lowered, the instrument will prompt "Please close the lid" in the middle of the interface. Before taking the pedestal measurement, remove the cuvette so that the lid is placed in the correct position.

---

4. Select a standard point, add the corresponding standard as the above blank measurement, click the measurement button to start the measurement, and then do the sample measurement after all the standard points are measured. If the "Repeat" setting is greater than 1, repeat the measurement.
5. After the standard point measurement is completed, a prompt box will pop up to confirm whether to continue adding the standard. After the standard is not added, enter the sample measurement mode. Add the 2 $\mu$ l sample to the measurement base as described above, and click the measurement. The button starts to measure the sample. There is no need to perform a blank measurement between the test standard and the sample.

Pedestal mode: If "Auto measure" is turned on in "Settings", put down the lid and start measurement automatically. If "Auto measure" is set to "Off", lower the lid and click measure.

Cuvette mode: Click to measure.

---

**Note** Each sample measured must be new.

---

### After the measurement is completed

Wipe the upper and lower pedestals with dry airlaid paper so the instrument can perform the next sample measurement.

When using a cuvette, remove the cuvette, thoroughly clean the cuvette and allow to dry.

## 5.14 Protein Pierce 660

### 5.14.1 Overview

Protein Pierce 660 is primarily used to quantify total protein concentrations containing reducing agents or detergents using a reagent/sample volume ratio of 15:1. When using pedestal measuring, a 4  $\mu$ l sample and 60  $\mu$ l of reagent are recommended.

Prepare standards and build standard curves according to the manufacturer's instructions. Ensure that the processing time and ambient temperature of each sample are consistent throughout all measuring procedures. Protein standards for constructing standard curves can be purchased from kit manufacturers.

### 5.14.2 Pierce 660 Measurement Range

When using 4 µl of sample and 60 µl of reagent, Pierce 660 nm can measure concentrations ranging from 50 µg/ml to 125 µg/ml.

The sampling curve shows the absorbance of the current sample calibrated to a 10 mm pathlength.

**The measurement results include the following:**

**Sample Name** — Enter the name of the sample before performing sample measurement.

**Measurement type** — Whether the measurement is a cuvette or a pedestal.

**Creation time** — The system time at which the test was performed.

**Concentration** — The concentration unit of the current sample.

**Absorbance value (660nm)** — The absorbance of the complex at 660 nm.

**Curve type** — Displays the type of curve of the current standard curve, including discrete, linear, multi-order equations, etc. The default selection is linear.

**Repeat times** — Enter the reference product or the number of times the same standard or averaged sample is measured, resulting in a concentration value associated with it.

**Standard** — Enter the actual concentration value for each standard.

**R<sup>2</sup>** — Indicates the extent to which the standard curve fits the standard data points (1.0 indicates perfect fit; all points are on the curve).

---

**Note** The state of the effective curve simply indicates that the number of samples tested has met the minimum sample point required for the standard curve. The standard curve state does not indicate the fit of the standard curve. To include a wider range of detection concentrations, a larger number of standard points are required.

---

### 5.14.3 Standard curve

A standard curve must be constructed before testing. It is recommended to use dyes without protein for blank controls and references.

---

**Note** This is not the same as other protein quantification. Other protein quantification methods use water as the blank control.

---

A simplest standard curve can consist of two points, including two standard points. The standard curve can include up to 7 standard points, and there is no order requirement for testing each standard point.

The standard point can only be added to the standard curve at the time of sample measurement. When the first sample is tested, the standard point cannot be added to the standard curve.

---

**Note** If a previously saved experimental record is selected, the concentration calculations for all samples are based on the standard curve in the experimental record. Only one standard curve can be saved for each experimental record.

---

### 5.14.4 Performing Protein Pierce 660 Measurement

Prepare the sample with reference to the reagent manufacturer's instructions.

Prepare standards and samples according to the manufacturer's instructions. The blank used should be the same as it of the standard, such as the pH and salt concentration.

The concentration range of the standards should cover the concentration range of the full samples.

**Operation process:**

1. Select the "Protein" on the Home page and click on "Pierce 660".
2. Enter the concentration of each standard in the parameter settings, the software can detect up to 7

standards. Standard points can be tested multiple times.

---

**Note** The standard curve requires a minimum of 2 standard points. It is recommended to test multiple standards. The concentration range of the standards should cover the concentration range of the samples. For this analysis, the recommended setting is "Linear"

---

3. Clean the upper and lower pedestals with the airlaid paper and use a suitable buffer as a blank control. Pure water is usually used as a blank control.  
Pedestal mode: Add 1-2ul of pure water to the pedestal, close the lid and click on the blank measurement.  
Cuvette mode: When inserting a cuvette, please note the direction of the arrow on the instrument to insert. The beam (2mm wide) is positioned 8.5mm above the bottom of the cuvette. Add liquid as recommended by the cuvette manufacturer.

---

**Note** When detecting in any mode, the lid must be closed. If the lid is not closed, the instrument will prompt "Please close the lid" in the interface. When using the pedestal mode, it is recommended to remove the cuvette from the instrument to ensure that the lid is in the proper position.

---

4. Select a standard point, add the corresponding standard as the above blank test, click "Measure" to start the test, and then do the sample test after all the standard points are measured. If the "Repeat" setting is greater than 1, repeat the test.
5. After the standard point measurement is completed, a prompt box will pop up to confirm whether to continue adding the standard. After the standard is no longer added, enter the sample measurement mode. Add the 2ul sample to the test pedestal as described above. Click Measure. The button starts to measure the sample. There is no need to perform a blank test between the test standard and the sample.  
Pedestal mode: If "Auto measure" is turned on in "Settings", put down the lid and start measurement automatically. If "Auto measure" is set to "Off", close the lid and click Measure.  
Cuvette mode: Click to measure.

---

**Note** Each sample tested must be freshly added !

---

**After the test is completed:**

Clean the upper and lower pedestal with airlaid paper so the instrument can be used for the next sample. When using the cuvette mode, remove the cuvette, rinse thoroughly and then perform the next sample test.

## 5.15 OD600

### 5.15.1 General

The OD600 test uses a spectrophotometer to measure the scattered light transmitted through the cell suspension to obtain a corresponding absorbance value. For this instrument, the biggest difference between pedestal measurement and cuvette measurement is that the optical path is different, and the spectrogram shows the spectral measurement results from 250 nm to 700 nm. The growth rate of

bacterial or other microbial cell cultures was measured using an OD600 application by detecting the absorbance of the cell growth culture at 600 nm. The Beer-Lambert equation and the user-converted conversion factor are used to correlate absorbance and concentration. The reported concentration values can be used to determine the stage of the cultured cell population.

### Sample uniformity

Make sure that the sample is uniform before testing. Mix the sample well and add it to the pedestal before using the pedestal mode. Use the stirring function when using the cuvette mode.

### Measurement range

Owing to the relatively short measurement path, the instrument can measure relatively high concentrations of cell suspension. Because the spectrum of the larger band can be displayed. Thinner/lower concentration samples can be measured at lower wavelengths, for example at 400 nm. Users can also use cuvettes to measure relatively thin samples.

### Disinfection of the pedestal

If disinfection is required, please use a disinfectant. For example, 0.5% sodium hypochlorite can be used to clean the pedestal to ensure that no bioactive material remains on the pedestal.

---

<b>Note</b>	<b>Do not</b> use a watering can to spray disinfectant against the instrument. Use a disinfectant to wet the airlaid paper to wipe the upper and lower pedestals of the instrument and the outside of the instrument. Then clean the instrument with the airlaid paper dipping with the pure water. Finally, wipe the instrument with a dry paper.
-------------	--

---

The sampling curve shows the absorbance of the current sample calibrated to a 10 mm path length.

**Sample Name** - Enter the name of the sample before performing sample testing.

**Measure type** - select the test is a cuvette mode or a pedestal mode.

**Creation time** - the system time at which the test was performed.

**Absorbance Correction** - The user can customize the baseline value, adjusted by input data, with the absorbance value between 0 and 300 A, and the absorbance correction value will be subtracted from the absorbance at all wavelengths in the sample spectrum.

**600 nm (Abs)** - absorbance at 600 nm using a user defined baseline.

**Other measure wavelengths ( $\lambda$ )** - user-defined wavelengths, if desired, can be input to another wavelength for measurement (for diluted samples exhibiting low absorbance at 600 nm), and if another wavelength is specified, the wavelength is used to calculate the cell concentration.

**A( $\lambda$ )** - The user specifies the normalized and corrected absorbance values for the other measured wavelengths ( $\lambda$ ).

**Coefficient ( $10^8$ )** - user-defined factor. A recognized coefficient for detecting cell type, or empirically studying a solution of cells by using a known concentration of the same medium. The default value is  $1 \times 10^8$  which is a recognized factor for most bacterial cell suspensions, such as E. coli.

**Cell culture concentration ( $10^8$ )** - the reporting unit is the number of cells / ml. The corrected A600 absorbance value was calculated based on the Beer-Lambert equation.

## 5.15.2 Perform OD600 concentration measurement

1. On the Main interface, select the "Others" and click "OD600"
2. If necessary, specify the cell number conversion factor and the second measurement wavelength or absorbance correction in the "Parameter Settings".
3. Clean the upper and lower pedestals with airlaid paper and use a suitable buffer as a blank control.

Pure water is usually used as a blank control.

Pedestal mode: Add 2 ul of blank control to the pedestal, lower the lid and click on the blank measurement.

Cuvette mode: When inserting a cuvette, note the direction of the arrow on the instrument. The beam (2mm wide) is positioned 8.5mm above the bottom of the cuvette. Add liquid as recommended by the cuvette manufacturer.

---

<b>Note</b>	When detecting in any mode, the lid must be closed. If the lid is not closed, the instrument will prompt "Please close the lid" in the middle of the interface. When using the pedestal, it is recommended to remove the cuvette from the instrument to ensure that the lid is in the proper position.
-------------	--

---

4. Add the sample as you do the blank test and click "Measure" to start the test.

Pedestal mode: If "Auto measure" is turned on in "Settings", put down the lid and start measurement automatically. If "Auto measure" is set to "Off", close the lid and click Measure.

Cuvette mode: Click to measure.

---

<b>Note</b>	Each sample must be new.
-------------	--------------------------

---

**After the test is completed:**

Clean the upper and lower pedestals with airlaid paper so the instrument is ready for the next sample.

When using the cuvette mode, remove the cuvette, rinse thoroughly and then perform the next test.

## 5.16 UV-VIS

### 5.16.1 General

The UV-visible function allows the instrument to function like a normal UV-Vis spectrophotometer. The absorbance of samples from 185 to 910 nm can be displayed, and up to 40 wavelengths can be specified for absorbance measurement.

### 5.16.2 Measurement concentration range

In the automatic adjustment optical path mode, the instrument can measure the absorbance value of 300A corresponding to the 10mm optical path.

The sampling curve shows the absorbance of the current sample calibrated to a 10 mm path length.

Includes the following:

**Sample Name** - Enter the name of the sample before performing sample testing.

**Measure type** - select the test is a cuvette mode or a pedestal mode..

**Creation time** - the system time at which the test was performed.

**Automatic adjustment of the optical path** - automatically adjust the appropriate optical path when detecting high concentration samples. If this function is selected, when the absorbance at any wavelength between 220 nm and 900 nm is about 1.25, measurement uses a short optical path. For the wavelength range from 190 nm to 219 nm, the absorbance at 1 mm pathlength is about 1.0 and then the short path length measurement is used.

Short path lengths are very useful for high concentration sample testing. Although this function is automatically performed for other applications, the user can choose the function to automatically adjust the

optical path under the UV-visible function. The default absorbance data of the software is displayed as data in the 1mm optical path.

**Baseline Correction** - If baseline correction is selected, the default calibration wavelength is 750 nm and the user can enter different calibration wavelengths depending on the test. Under any test, the baseline is automatically set to the absorbance at the calibration wavelength. The reading at all wavelengths is subtracted from this value. If you do not select Baseline Correction, the baseline of the spectrum will shift and the calculated concentration will be higher than the true value.

**Add measure wavelength** - click to add measurement wavelength, it will increase one line of measurement wavelength, input wavelength value (range between 185~910), up to 40 measurement wavelengths.

 - Click to delete one line of measurement wavelength.

### 5.16.3 Performing UV-visible inspection

1. Select "Others" on the Main and click UV-Vis.
2. Specify up to 40 wavelengths to be measured and whether to use automated path adjustment.
3. Baseline correction can be selected. The default calibration wavelength is 750nm. You can also re-enter a calibration wavelength.
4. Select the overlay display to display the experimental results of multiple test samples in the sample curve box.
5. Clean the upper and lower pedestals with airlaid paper and use a suitable liquid to create a blank control that will dissolve the target solution.

The pH and ion concentration of the blank control liquid should be the same as the test sample.

Pedestal mode: Add 1-2 ul of blank solution to the pedestal, close the lid and click on the blank to measure.

Cuvette mode: When inserting a cuvette, please note the direction of the arrow on the instrument. The beam (2mm wide) is positioned 8.5mm above the bottom of the cuvette. Add liquid as recommended by the cuvette manufacturer.

---

**Note** When detecting in any mode, the lid must be closed. If the lid is not closed, the instrument will prompt "Please close the lid" in the middle of the interface. Before taking the pedestal test, remove the cuvette so that the lid is placed in the correct position.

---

6. Add the sample as you do the blank test and click "Measure" to start the test.

Pedestal mode: If "Auto measure" is turned on in "Settings", put down the lid and start measurement automatically. If "Auto measure" is set to "Off", close the lid and click Measure.

Cuvette mode: Click to measure

---

**Note** Each sample tested must be new.

---

#### After the test is completed:

Clean the upper and lower pedestals with airlaid paper so the instrument is ready for the next sample.

When using the cuvette mode, remove the cuvette, rinse thoroughly and then perform the next sample test.

## 5.17 Kinetics

### 5.17.1 General

It can be used to compare the samples in the cuvette for kinetic measurements. Up to 3 wavelengths between 190 nm and 850 nm can be specified for user-defined intervals for continuous absorbance measurement in up to 5 stages.

### 5.17.2 Measurement range

The sampling curve shows the absorbance of the current sample calibrated to a 10 mm path length. Includes the following:

**Sample Name** - Enter the name of the sample before performing sample testing.

**Measure type** - select the test is a cuvette mode or a pedestal mode.

**Creation time** - the system time at which the test was performed.

**Sample type** - the type of test being performed.

**Stage** – at which stage of the measurement.

**Time** – The measurement time starting from the test starts.

**Cuvette pathlength** - the path length used in the test.

### 5.17.3 Kinetic measurements

1. Select “Others” on the Main interface and click on “Kinetics”.
2. The “Kinetics” screen will be displayed as shown in Picture 5-1. If there is one or more Kinetics methods in the currently selected data storage location, they will be listed in the left frame and a description of the selected method is displayed in the right frame.

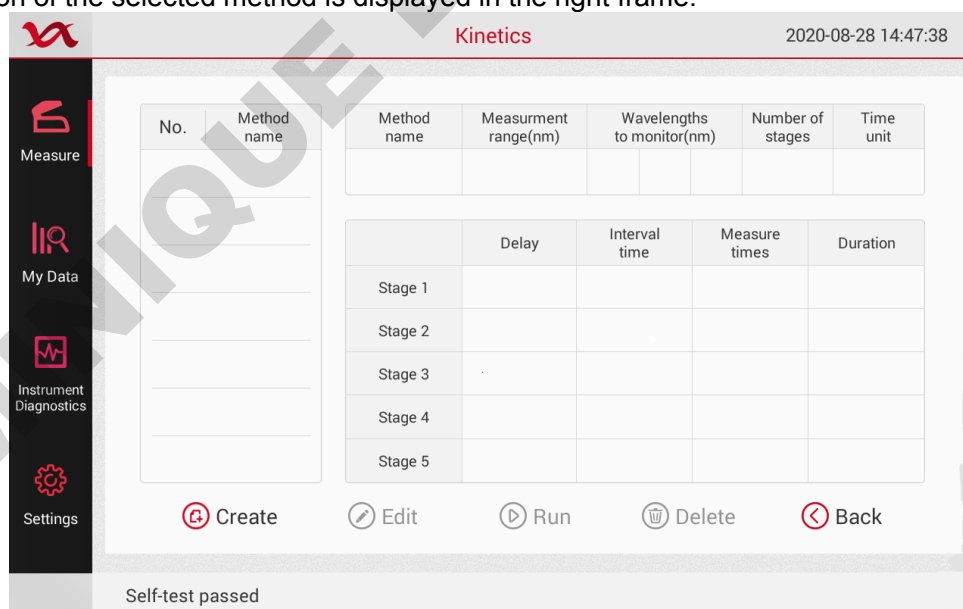

Picture 5-1

3. Choose a method:  
 Click on the method name in the left box and select an existing method.  
 Create a new method by clicking "Create", specifying the method settings and selecting the save method  
 Edit an existing method by clicking on the method name and selecting "Edit"

- Delete an existing method by clicking on the method name and selecting "Delete"
- Set the cuvette options by clicking on  > the General Settings, such as Heating or Stirring (see General Settings for details).  
Note: If the cuvette path is not 10mm, specify the correct path in the "General Settings".
  - Click Run.
  - Perform a blank test and fill a clean, dry cuvette with enough blank test solution to cover the instrument's optical path. Open the instrument lid and insert the blank measurement cuvette into the cuvette holder. Make sure that the cuvette's optical path is aligned with the instrument's optical path. Click on the blank to measure it.  
If "Heat to 37 °C" is turned on in the General Settings, a message will appear telling the current temperature and wait for the heater to reach the target temperature before starting the test. As shown in Picture 5-2, click on the blank immediately to start blank measurement. Wait for the blank measurement to complete, then remove the cuvette

---

**Note** Each sample tested must be new.

---

- Test the sample and fill in the clean and dry cuvette with enough blank measurement solution to cover the optical path of the instrument. Insert the sample cuvette into the cuvette holder, making sure to align the light path and click Measure. After starting the test, before all stages are completed, click "Stop" to end the experiment ahead of time and wait for all the measurement stages to complete.

---

**Note** The reagent can be added to the sample solution at any time during the test.

---

**After the test is completed:**

Remove the cuvette and clean it according to the manufacturer's specifications.

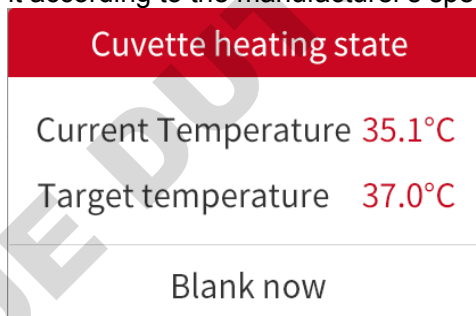

Picture 5-2

#### 5.17.4 Create a kinetics method

- Select "Others" on the Main interface and click on "Kinetics".
- Create a new method by clicking on "Create", specifying the method settings and selecting the save method as shown in Picture 5-3.



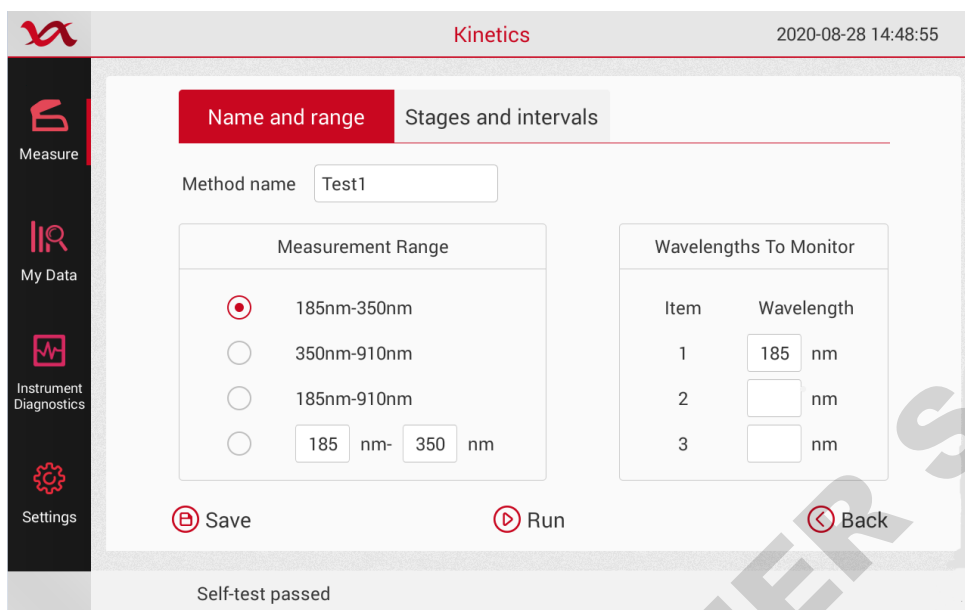

Picture 5-3

3. Enter the method name, select the wavelength range, and specify up to three measurement wavelengths.
4. Swipe the screen to the left. See Picture 5-4.  
 Select the number of stages and time units (minutes and seconds)  
 Specify the number of intervals, interval time, and delay between stages for each stage. The colored lines and boxes on the right clearly indicate the specific stages. The colored lines represent the start and end times of each stage, and the colored boxes correspond to the specific delays and measurements for each stage.  
 Click Save to save the method and return to the Kinetics menu.  
 Click Run to run the method

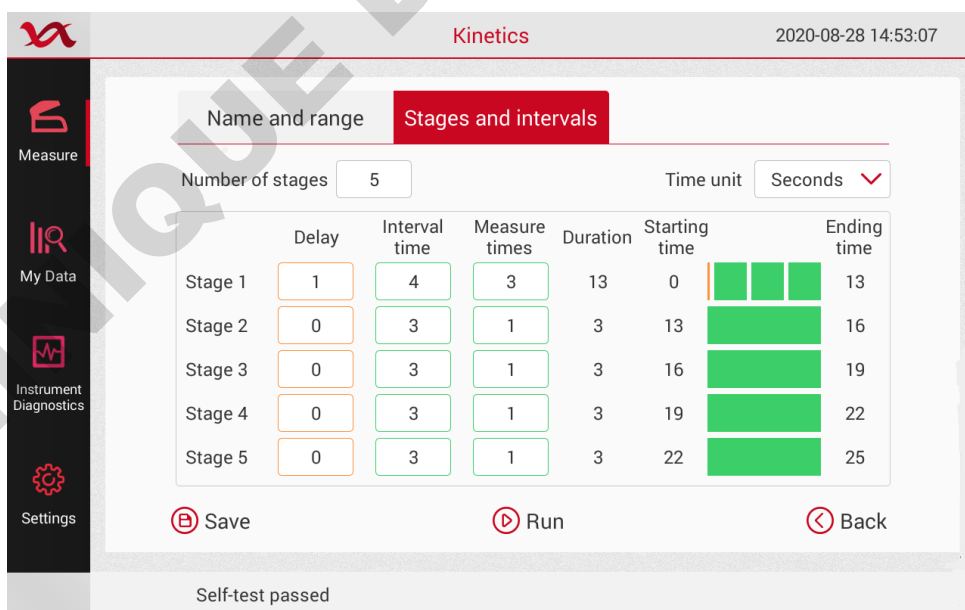

Picture 5-4

### 5.17.5 Editing a kinetics method

1. Select "Others" on the Main interface and click on Kinetics. See Picture 5-5.
2. Edit the existing method by clicking on the method name and selecting "Edit"

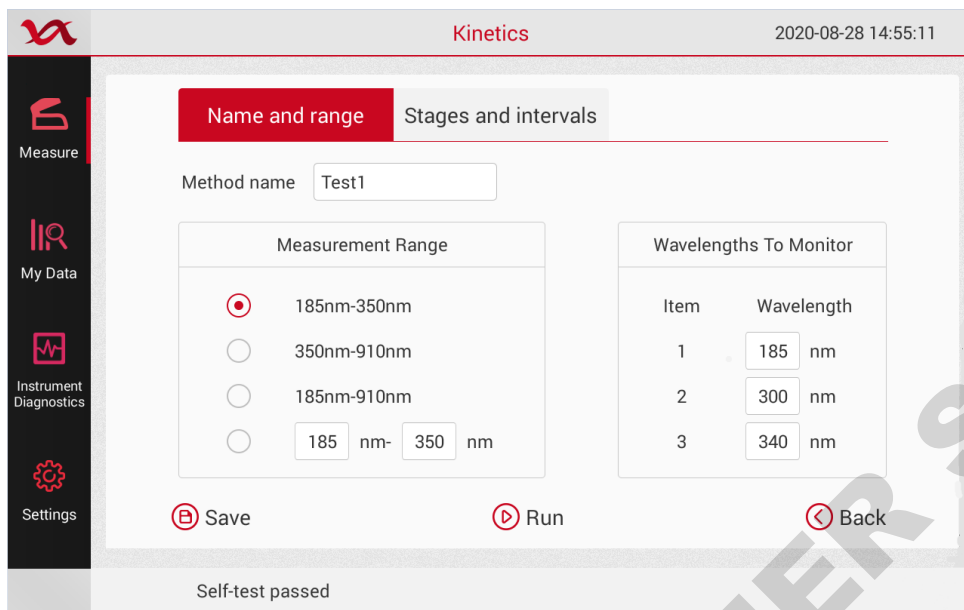

Picture 5-5

3. Enter the method name, select the wavelength range, specify up to three measurement wavelengths
4. Swipe the screen to the left. See Picture 5-6

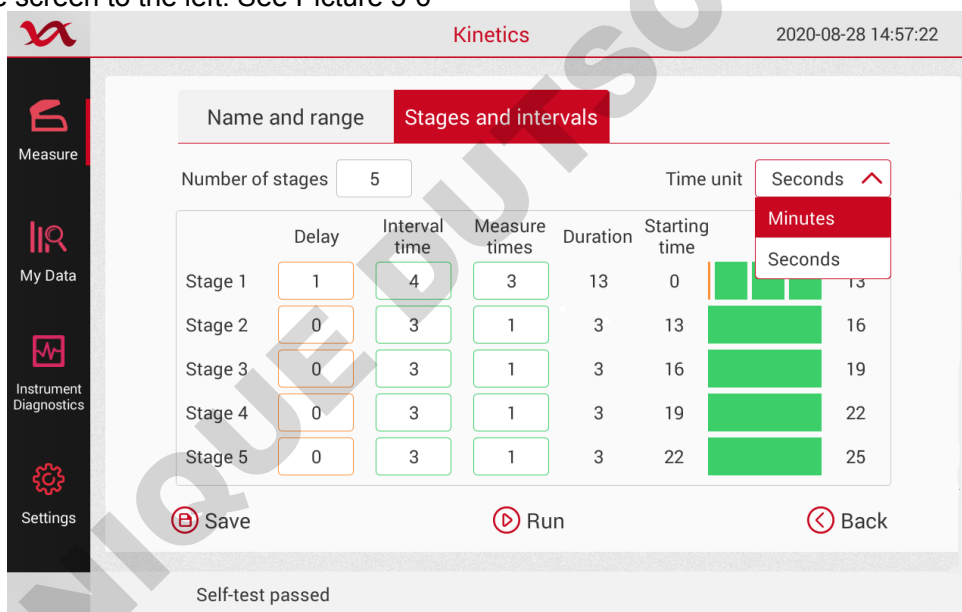

Picture 5-6

Select the number of stages and time units (minutes and seconds)

Specify the number of intervals, interval time, and delay between stages for each stage. The colored lines and boxes on the right clearly indicate the specific stage. The colored lines represent the start and end times of each stage, and the colored boxes correspond to the specific delays and measurements for each stage.

Click Save to save the method and return to the Kinetics menu.

Click Run to run the method.

## 6. My data and Settings

### 6.1 My data

#### 6.1.1 Introduction

Used to view saved experimental data. A list of experiments matching the current search criteria settings is displayed on the screen as shown in Picture 6-1. Search conditions include measure time range, measure type.

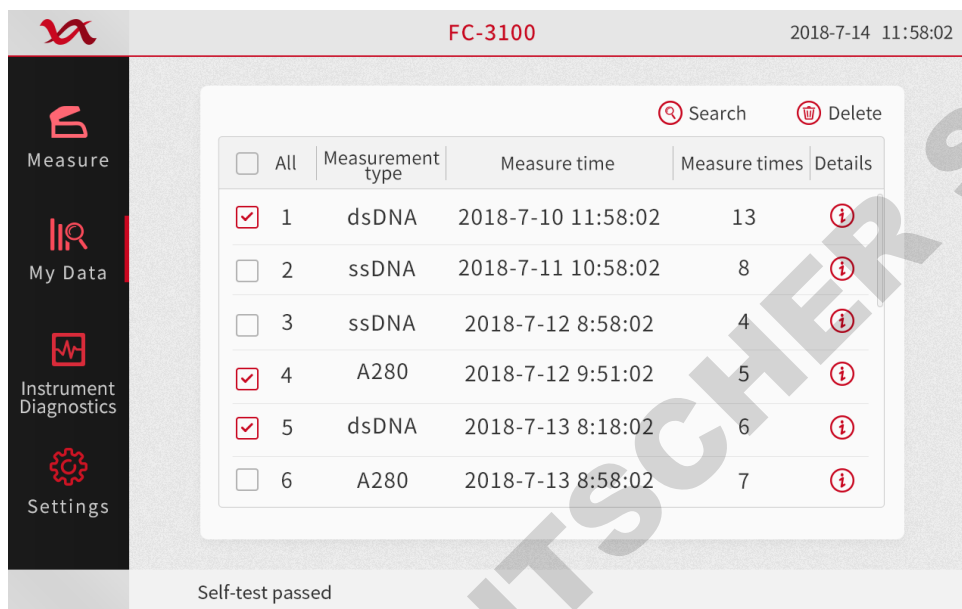

Picture 6-1

#### 6.1.2 My Data main function

1. Search: click on the "Main" and My data, enter the home page as shown in Picture 6-2, click the "Search" button below, enter the search page, select the screening criteria.

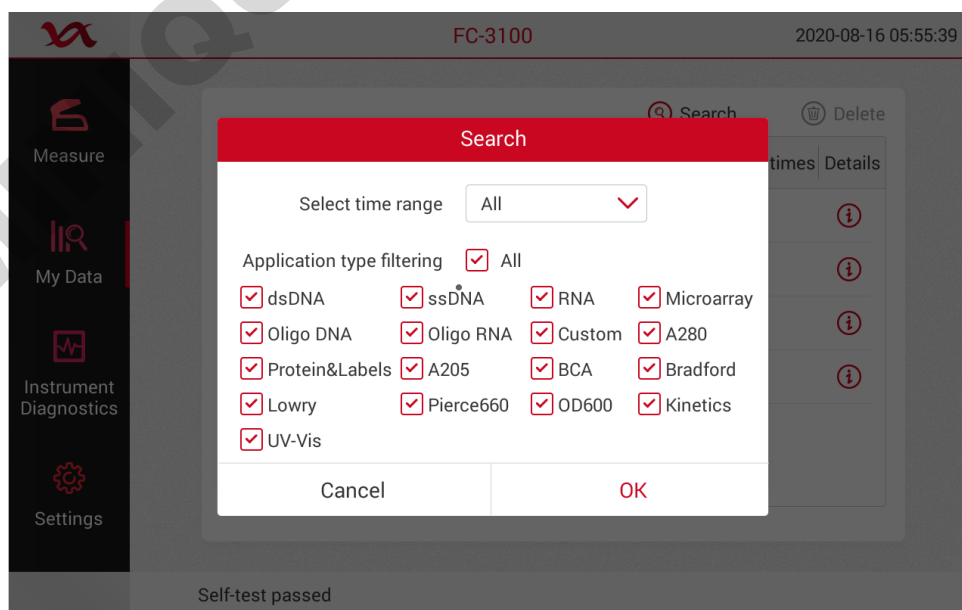

Picture 6-2

The search criteria include the following:

**Select time range** - the time of the experiment, there are "last 1 day", "last 2 days", "last 1 week", "last 2 weeks", "last 1 month", "last 2 months", "last 6 months" seven time range options.

**Application type filtering** - Used to filter to view the specified measure type, only the selected measure types will be displayed after selection. Click "Select All" to automatically check all measures.

2. Delete: Click My data in the "Main" and enter the homepage as shown in Picture 6-3. Press and hold a row to enter the selected state. When selected, the original "Find" button will change to "Delete".

Click Delete to delete the data from the database.

Note: Multiple lines can be deleted at the same time.

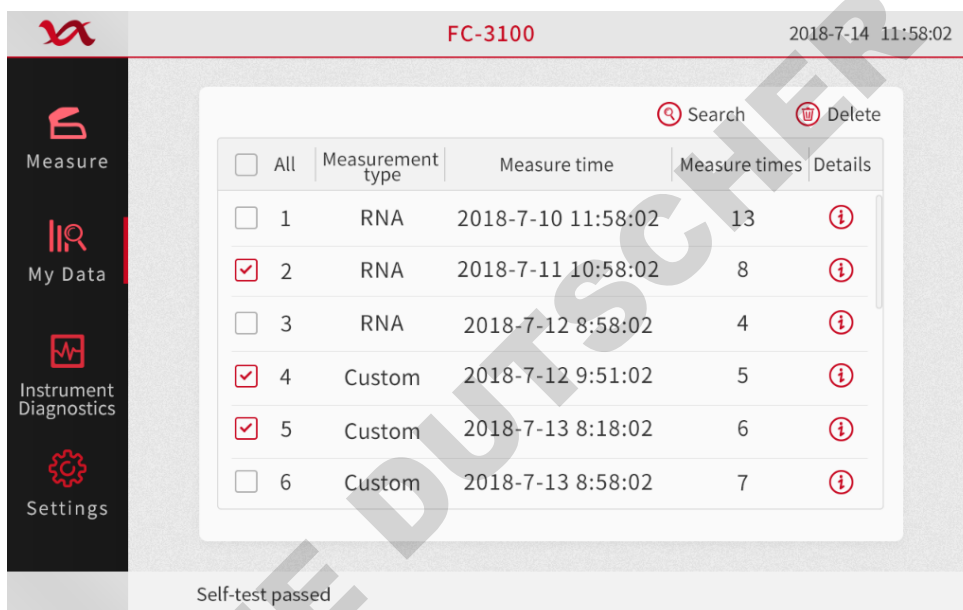

Picture 6-3

## 6.2 Settings

On the Main interface, Click Settings, or click or select settings in any test. The instrument settings are divided into four modules: system settings, general settings, dye editor and protein editor.

**Save:** After changing the settings, click the "Instrument Settings" option on the left, prompting "Do you want to save settings?", and select "OK" to save all operations of the settings in the settings page. And "Setting saved" is displayed, as shown in Picture 6-4.

**Cancel:** Click "Cancel" to cancel the operation on this page.

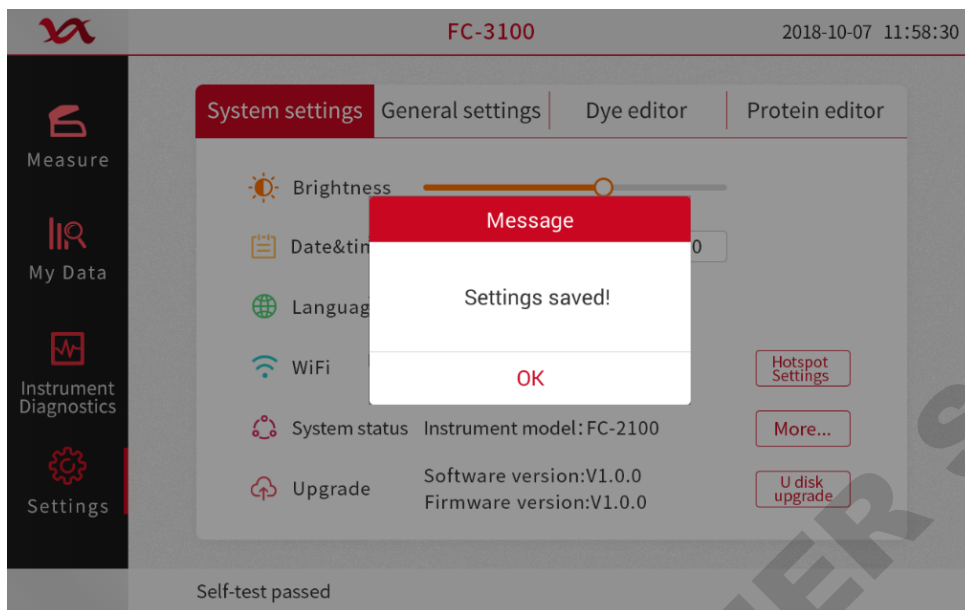

Picture 6-4

### 6.2.1 System settings

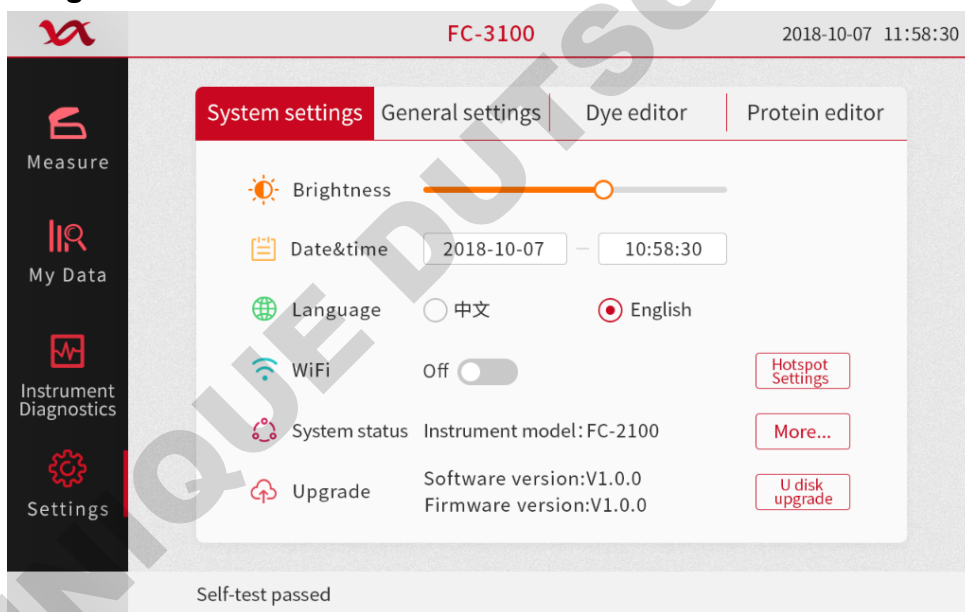

Picture 6-5

Includes the following:

- Brightness** - adjust the brightness of the instrument touch screen
- Date and time** - manually set the instrument's time and date, using the 24-hour time format
- Language**- switch instrument language, select Chinese or English
- WIFI** – WIFI hotspot settings
- System status**-Instrument model,Serial,Software version and Firmware version.
- Upgrade** - update the instrument software via a USB device connected to the instrument;

### 6.2.2 General Settings

As shown in Picture 6-6

Includes the following:

**Auto measure** - If the automatic measurement function is turned on, in the pedestal mode, after close the lid and the measurement is automatically started without need to click the Measure.

**Auto name** - Automatically use the name followed by a number starting with the "1" character to assign the sample name. Use the default (Sample).

**Using cuvette** - choose cuvette style (Only for FC series) as shown in Picture 6-7. If you choose this option, the following additional options will be available:

**Optical path:** Set the cuvette path (width) before using the cuvette for blank measurement or before sample measurement

**Stirring speed:** If stirring is used, put the stirring microspheres into the sample cuvette and set the stirring speed range.

**Heat to 37 ° C:** If the sample cuvette needs to be heated, select this and the cuvette heater will heat the cuvette to 37 ° C.

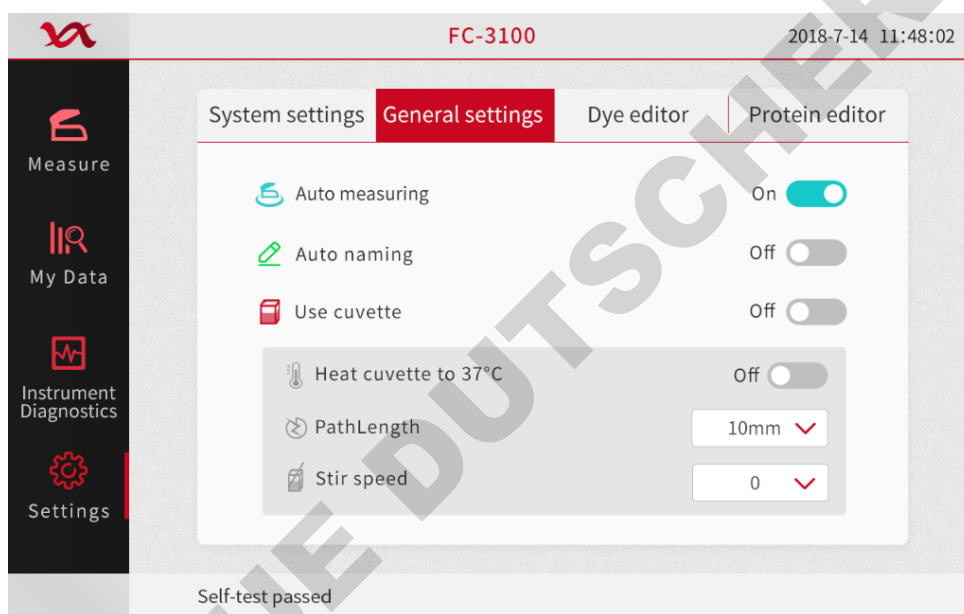

Picture 6-6

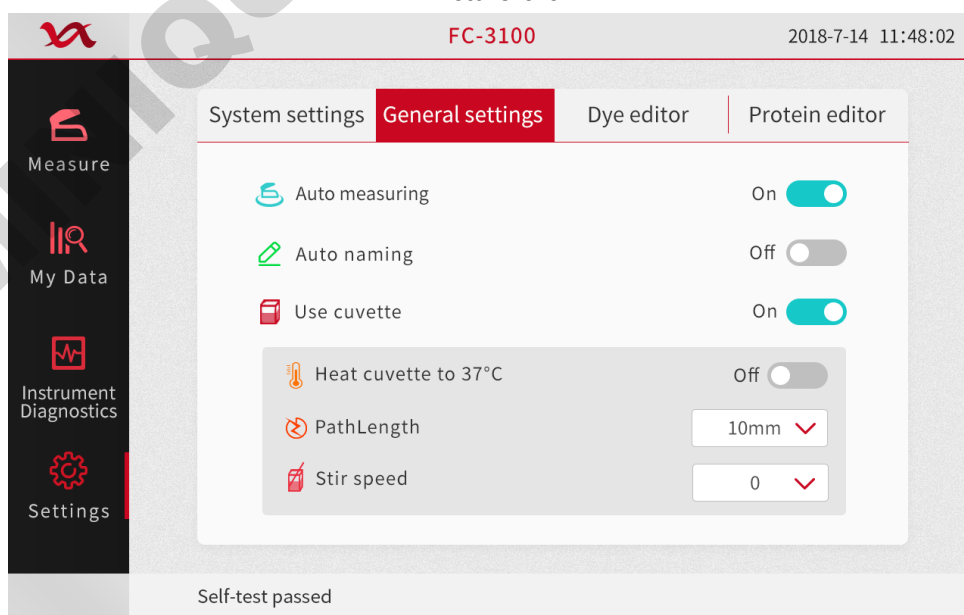

Picture 6-7

### 6.2.3 Dye Editor

User-defined dyes can be used with the dye editor. Add to the list of available dyes in the Micro Array Parameter Settings or Protein&Labels Parameter Settings. You can also specify the available dyes in the list.

If a dye is selected prior to measurement, a correction is applied to the measured sample absorbance value and the resulting sample concentration and purity ratio.

To use the Dye Editor, on the Main interface, click Settings to enter the Settings page and select the Dye Editor tab as shown in Picture 6-8.

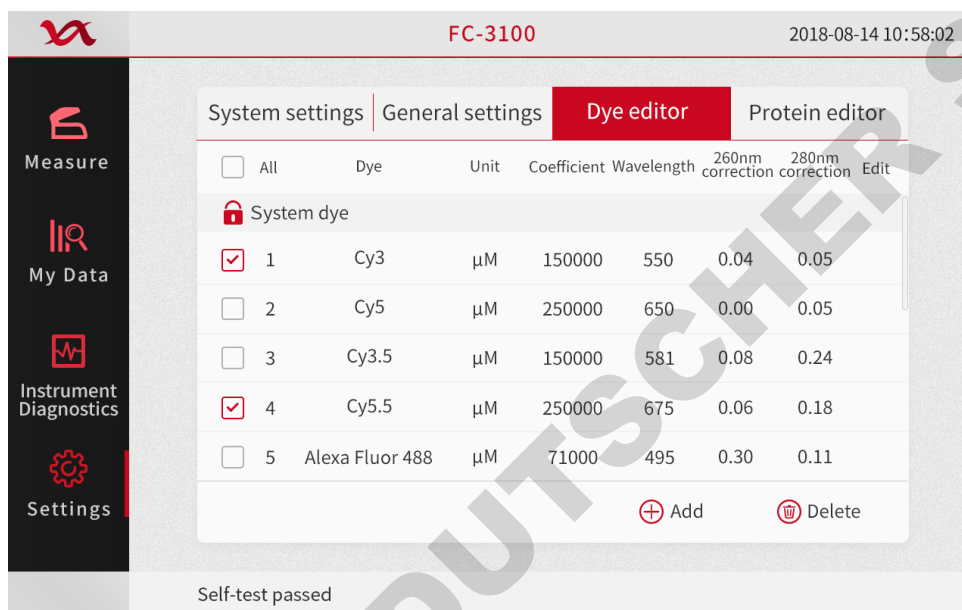

Picture 6-8

The dye editor includes the following operations:

- 1) Indicates default dyes (not editable or deleted)
- 2) User-defined dyes (editable or deleteable)
- 3) Add or remove dyes: To add or remove the Micro Array 1 parameter settings or the Protein&Label 2 parameter settings in the Dye 1 and Dye 2 drop-down lists, select or not select the checkbox of corresponding dyes.

<input checked="" type="checkbox"/>	1	Cy3	μM	150000	550	0.04	0.05
-------------------------------------	---	-----	----	--------	-----	------	------

- 4) Add user-defined dyes: Click the “Dye Editor” tab and the “Add” button to automatically add a custom dye to the bottom.
- 5) Edit the user-defined dye: Click on the “Dye Editor” tab and click on a line to enter the edit state as shown in Picture 6-9.

**Dye:** Enter a unique name for the new dye

**Unit:** The default unit selected shows the concentration of the dye

**Coefficient:** The extinction coefficient of the input dye in L/mole-cm (usually provided by the dye manufacturer)

**Wavelength:** The specified wavelength in nm (between 450 nm and 700 nm). Used to measure the absorbance of dyes.

**260nm correction:** 260nm correction value for the specified dye

**280nm correction:** 280nm correction value for the specified dye

Note: To determine the dye correction value (if not provided by the dye manufacturer), then the

instrument was used to measure the pure dye and user should note the absorbance at 260 nm, 280 nm and the absorbance at the dye analysis wavelength.

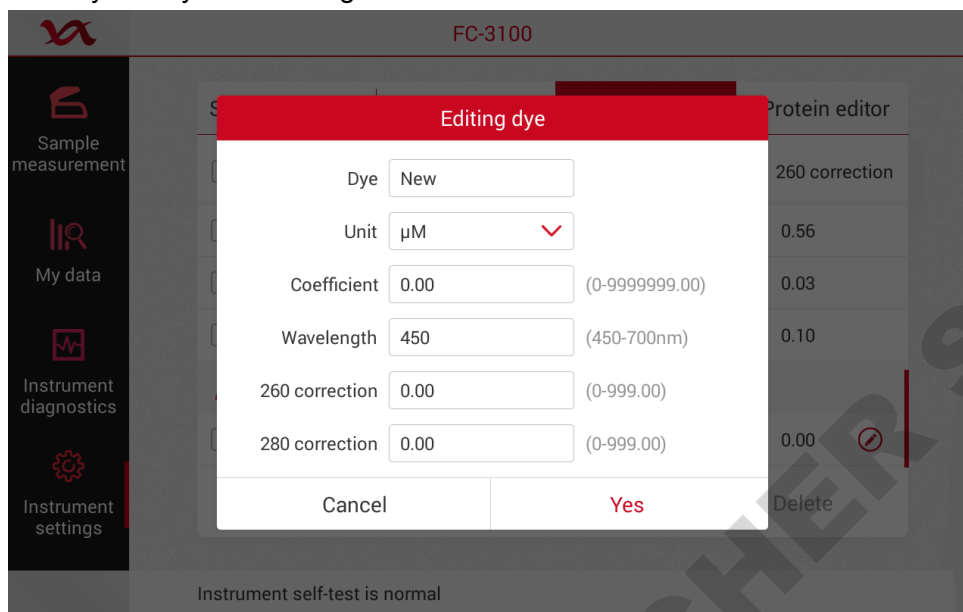

Picture 6-9

- 6) Delete the user-defined dye: Click the “Dye Editor” tab, long press a line, select the dye, click “Delete”, permanently delete this user customized dye.

### 6.2.4 Protein Editor

Use the Protein Editor to add custom proteins to the list of available protein sample types in Protein A280 Parameter Settings and Micro Array Parameter Settings. As shown in Picture 6-10.

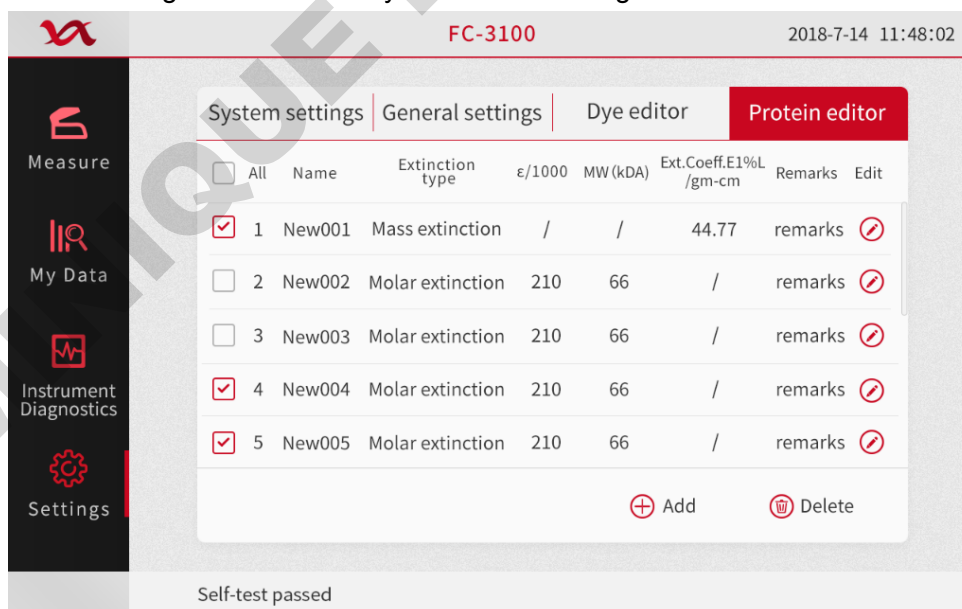

Picture 6-10

When use the Protein Editor, on the Main interface, click the Settings to enter the settings page and select the Protein Editor.

The Protein Editor includes the following operations:

- 1) Add custom protein: Click the “Add Protein” button under the “Protein Editor” to automatically add a custom protein to the bottom.



2) Edit the custom protein: Click on the “Protein Editor” and click on a line to enter the editing state. As shown in Picture 6-11.

**Name:** Enter a unique name for the protein

**Extinction type:** Specify the “molar extinction coefficient” or “mass extinction coefficient” that the user uses for the customized protein. If the mass extinction coefficient is selected, enter the mass extinction coefficient for the 10 mg/ml ( $\epsilon_{1\%}$ ) protein solution in L/gm-cm. If the molar extinction coefficient ( $\epsilon$ ) is chosen, the unit is  $M^{-10mm^{-1}}$  divided by 1000 (ie,  $\epsilon/1000$ ). For example, for a protein with a molar extinction coefficient of 210,000  $M^{-10mm^{-1}}$  enter 210. The unit of input is the molecular weight (MW) of kilodaltons (kDa).

**Remarks:** Add a note to the protein.

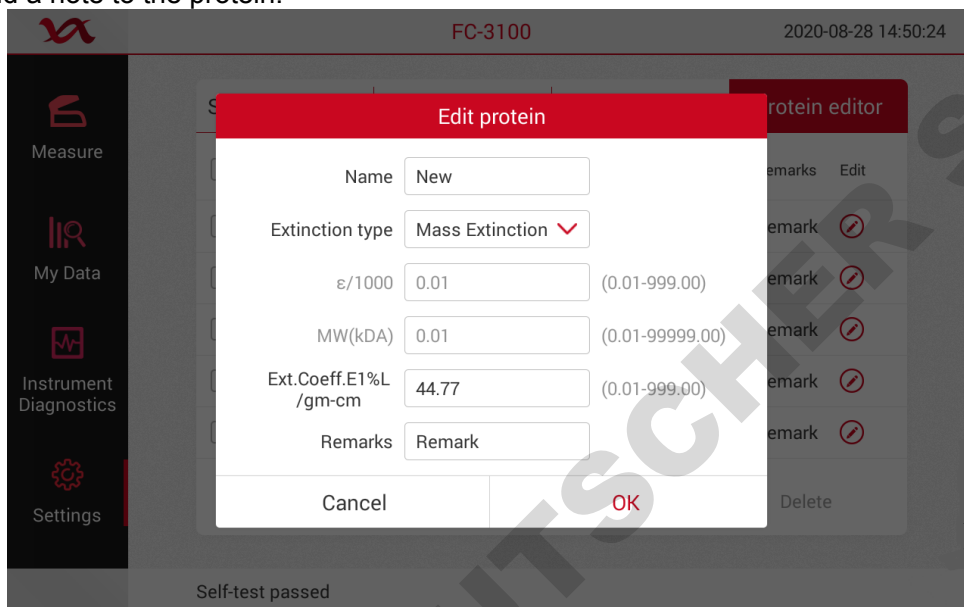

Picture 6-11

3) Delete the custom dye: Click on the “Protein Editor”, long press a line, select the protein, click “Delete” to permanently delete the custom protein.

## 7 Diagnosis

Spectrum intensity diagnosis, confirm whether the internal spectrometer is operating normally and calibrated; spectral diagnosis confirms whether the fiber movement is normal.

### 7.1 Spectrum intensity diagnosis

Go to the instrument main page and click the “Instrument Diagnostics” button to enter the instrument diagnosis interface. As shown in Picture 7-1:

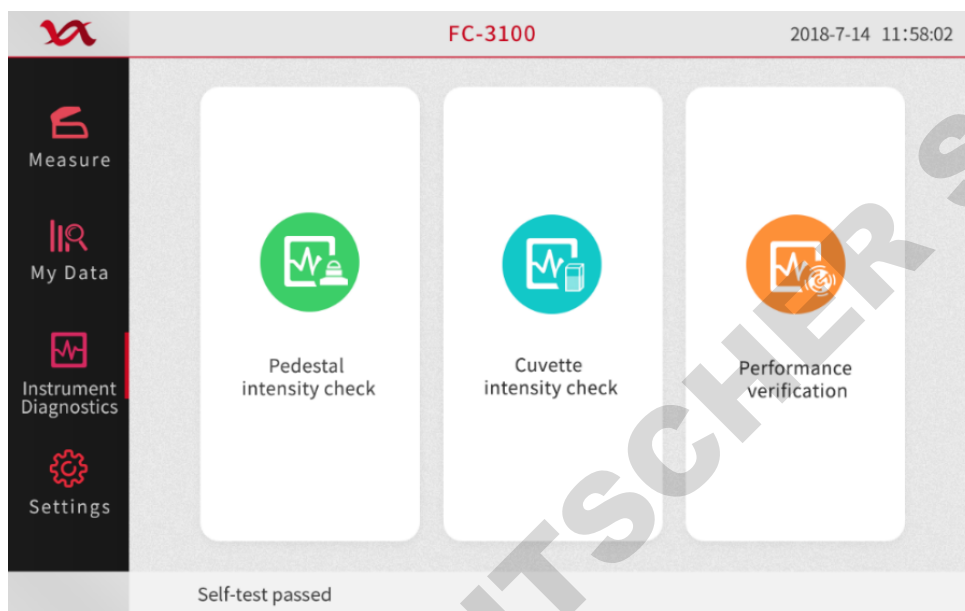

Picture 7-1

#### 7.1.1 Pedestal spectrum intensity diagnosis

1. Click “Pedestal Spectrum Intensity Diagnosis” on the “Instrument Diagnostics” interface to enter the related interface, as shown in Picture 7-2:
2. Do not add any reagents on the pedestal. Click the Measure button on the screen.
3. After the test is completed, the spectrum in the upper right corner of the screen: UV, offset, and visible are all marked in green as “√”, then the pedestal spectrum intensity is normal. If there is a red “X”, please contact our aftersales department for troubleshooting.

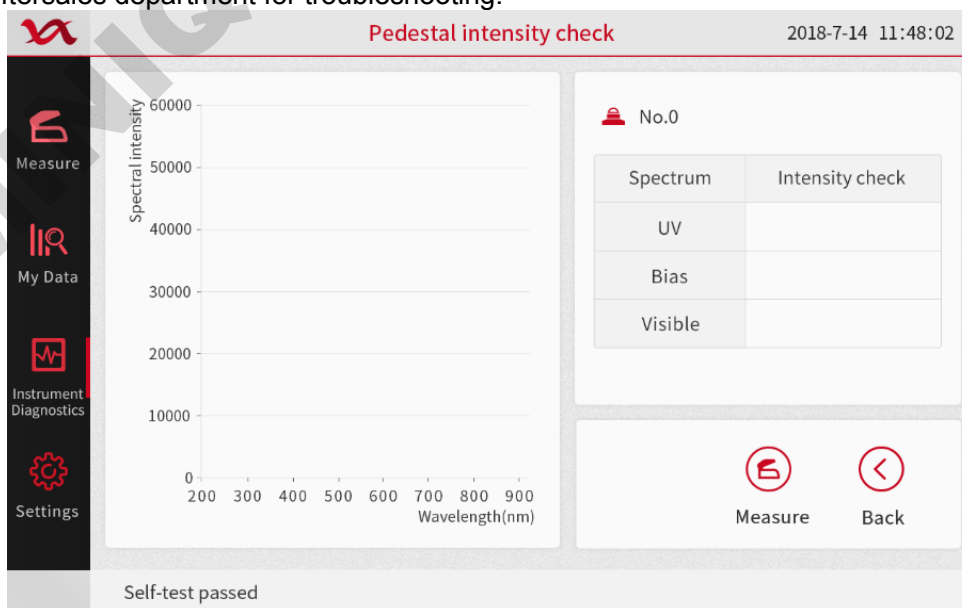

Picture 7-2

### 7.1.2 Cuvette spectrum intensity diagnosis

1. Click “Cuvette Spectrum Intensity Diagnosis” on the “Instrument Diagnostics” interface to enter the related interface as shown in Picture 7-3.
2. Don't add any reagent to the cuvette cell. Click the measurement button on the screen.
3. After the test is completed, the spectrum in the upper right corner of the screen: UV, offset, and visible are all marked in green as “√”, then the spectral intensity of the cuvette is normal. If there is a red “X”, please contact our aftersales department for troubleshooting.

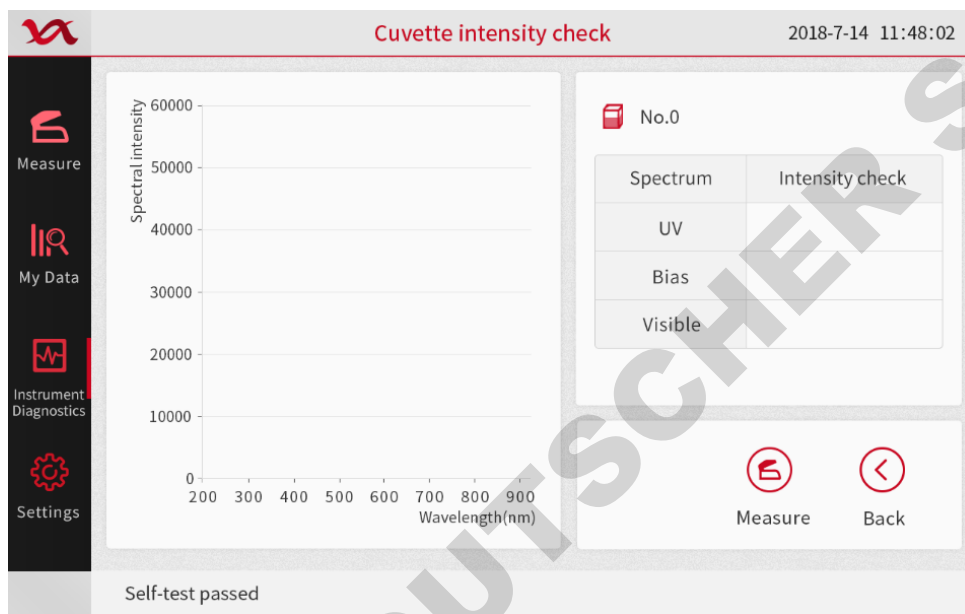

Picture 7-3

### 7.2 Spectral diagnosis

1. After the spectrum intensity diagnosis is finished, click “Spectral Diagnosis” to enter the “Spectral Diagnosis” interface. As shown in Picture 7-4.
2. Take 1-2 ul of blank solution onto the pedestal, close the lid and click on the blank measurement.
3. Wipe the blank liquid on the pedestal with an airlaid paper. Add 2 ul of potassium dichromate to the pedestal and click the measure.
4. The measured value will be displayed in the current absorbance value and the average absorbance value (average of the multiple measurements of potassium dichromate), and the corresponding error should satisfy 1mm, within 2% of the error, within 5% of 0.2mm error, within 15% of 0.1mm error, within 35% of 0.05mm error, within 45% of 0.03mm error.

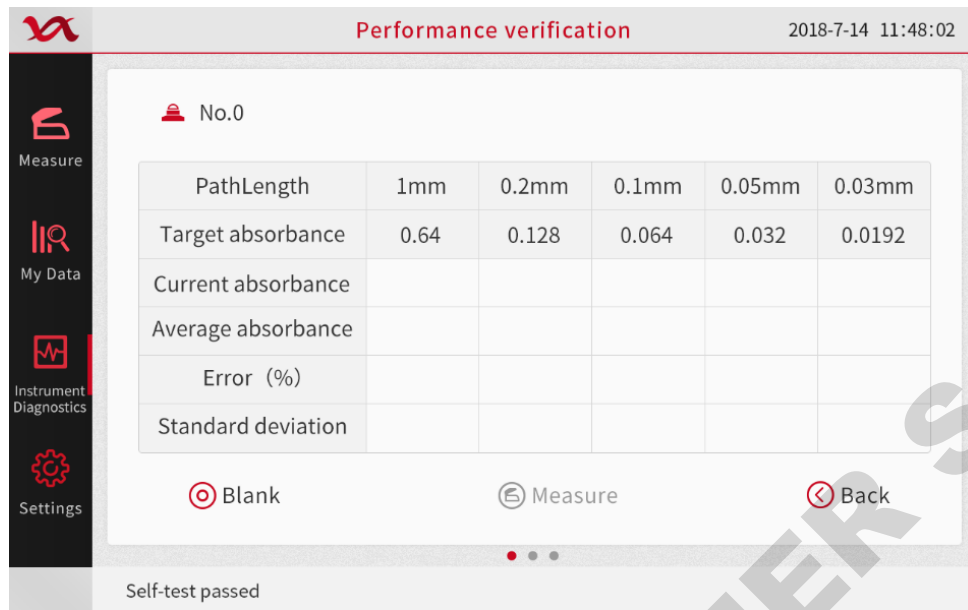

Picture 7-4

**Note:** Spectral diagnosis needs to be done ten times. After ten measurements, the relevant data will be automatically stored in the software to complete the spectrum diagnosis.

## 8. Alarms and tips

When the prompt message comes as below, please follow up the instruction of solution.

### 8.1 This experiment data is abnormal

Solution: The lid is opened during the measuring. Wipe the pedestal and cuvette pool cleanly with an airlaid paper and measure again.

### 8.2 The xenon lamp is abnormal

Solution: Check if the lid is open, check if the pedestal is clean, if there is a light block in the cell of the cuvette, wipe the pedestal fiber cleanly with an airlaid paper, and restart the instrument to complete the measurement.

### 8.3 Spectrometer communication failed

Solution: 1. Measure again, 2. Restart the instrument and measure again.

### 8.4 Base motor is abnormal

Solution: Restart the instrument and measure again.

### 8.5 The pedestal motor is blocked

Solution: Restart the instrument

### 8.6 The pedestal channel was not found

Solution: Check if the lid is open, check if there is any foreign object on the pedestal, wipe the pedestal fiber cleanly with an airlaid paper, and restart the instrument and measure.

### 8.7 The cuvette channel was not found

Solution: Check if the lid is open, check if there is any foreign object on the pedestal, wipe the pedestal fiber cleanly with an airlaid paper, and restart the instrument and measure.

### 8.8 Communication failed

Solution: Restart the instrument and measure again.

### 8.9 The operation timed out

Solution: Restart the instrument and measure again

### 8.10 Initialization failed

Solution: Restart the instrument

### 8.11 Can't find the available installation package

Solution: Insert the USB disk including the installation package into the computer, open the USB flash drive, and check the file directory "The instrument\_FILES /The instrument\_UPDATE /" whether there is an upgrade program "The instrument.bin" and "The instrument.apk" .

### 8.12 Unable to get the installation package information

Solution: 1. Restart the instrument and perform the software upgrade operation again.

2. Contact the after-sales personnel.

### **8.13 Upgrade failed**

Solution: Restart the instrument and perform the upgrade operation again.

### **8.14 No U disk found**

Solution: Make sure that the USB flash drive is plugged into the USB port of the instrument, remove and insert the USB flash drive again, and confirm that the USB flash drive is plugged into the position well.

### **8.15 U disk removed,export failed**

Solution: When the data is exported, confirm that the USB port of the instrument has been connected to the USB flash drive, remove and insert the USB flash drive, ensure that the USB flash drive communication is normal, and perform data export operation again.

### **8.16 Upgrade failed**

Solution: Confirm that the upgrade USB flash drive is plugged into the USB port of the instrument, the contact is good, restart the instrument, and upgrade again.

### **8.17 Please close the lid**

Solution: Check if the lid is closed. Measure again.

### **8.18 Please add sample again**

Solution: Wipe the pedestal and fiber (or cuvette fiber) with an airlaid paper, add sample again, make sure the amount of sample fitting with the standard and measure again.

### **8.19 The starting sequence number cannot be larger than the ending sequence number**

Prompt box prompt message: The starting sequence number cannot be larger than the ending sequence number.

Solution: The starting sequence number entered should be less than or equal to the ending sequence number.

### **8.20 The Starting sequence number cannot be 0**

Prompt box prompt message: The starting sequence number cannot be 0.

Solution: Start the sequence number and enter a number greater than 0.

### **8.21 Maximum input \***

Prompt box prompt message: maximum input \* (\* is the total number of experimental results in the instrument).

Solution: The amount of experimental data imported by the network cannot be greater than the total number of experimental data inside the instrument.

### **8.22 File already exists**

Prompt box prompt message: The file already exists!

Solution: In the local import, please select the experimental data that hasn't been imported.

### **8.23 The file type is incorrect**

Prompt box prompt message: The file type is incorrect!

Solution: Select a file with the file type of "CSV" and the correct contents to import.

### **8.24 The file you selected does not exist, please re-select**

Prompt box prompt message: The file you selected does not exist, please re-select!

Solution: Select the file that exists under the import directory.

### **8.25 Please connect the instrument first**

Prompt box prompt message: Please connect the instrument first.

Solution: Perform the online operations before performing a network import operation.

### **8.26 Connection failed, please reconnect**

Prompt box prompt message: The connection is failed, please reconnect.

Solution: Confirm that the instrument WIFI is on, confirm that the host computer is connected to the WIFI hot spot of the instrument, and click the "Connect" button again.

### **8.27 The instrument is measuring, please try again later**

Prompt box prompt message: The instrument is measuring, please try again later...

Solution: Check that the instrument is in an idle state and operate "Connect".

### **8.28 The same file name exists. Please close the file before proceeding.**

Prompt box prompt message: The same file name exists. Please close the file before proceeding.

Solution: When the PC exports, and the file has been exported, and the error occurs when it is open. The file needs to be closed before proceeding the export operation.

### **8.29 Starting time cannot be larger than the ending time**

Prompt box prompt message: The starting time cannot be larger than the ending time.

Solution: When screening experimental data, the starting time in the time condition should be no more than the ending time.

## 9 Failures and troubleshooting

If a fault occurs, check the cause of the fault according to the following table and take appropriate countermeasures to eliminate the fault.

**Table 9-1 Faults, reasons, and troubleshooting**

Faults	Reasons	Troubleshooting
No response after boot	Loose power plug	Plug in the power plug well
Accuracy error, repeatability error over range	<ol style="list-style-type: none"> <li>1. Sample absorbance is too high (&gt; 2A)</li> <li>2. Glass cuvettes are used in the band less than 350nm wavelength</li> <li>3. The cuvette is not clean enough</li> <li>4. There is dirt on the pedestal</li> <li>5. other reasons</li> </ol>	<ol style="list-style-type: none"> <li>1. Dilute the sample;</li> <li>2. Use a quartz cuvette;</li> <li>3. Wipe the cuvette clean;</li> <li>4. Remove dirt from the pedestal;</li> <li>5. Contact the company;</li> </ol>
Error after power-on or self-testing or switching wavelength path completion	<ol style="list-style-type: none"> <li>1. There is an objective blocking the light in the cuvette</li> <li>2. Glass cuvettes are used in the band less than 350nm wavelength</li> <li>3. The cuvette is not clean enough</li> <li>4. The pedestal has foreign objects</li> <li>5. Pedestal fiber not calibrated</li> <li>6. The switching part is stuck.</li> </ol>	<ol style="list-style-type: none"> <li>1. Clear the light blockage in the cuvette cell</li> <li>2. Use a quartz cuvette;</li> <li>3. Wipe the cuvette clean;</li> <li>4. Wipe the pedestal fiber clean;</li> <li>5. Contact the manufacturer</li> <li>6. Contact the manufacturer</li> </ol>

If the other fault occurs outside the above table, please contact the manufacturer so that we can solve the problem in time.



## 10 Use and maintenance

### 10.1 Pedestal Maintenance

#### 10.1.1 Sample Compatibility Instructions

The pedestal of the NanoReady micro volume UV-visible spectrophotometer is accessible to most solvents and solutions commonly used in life science laboratories, including methanol, ethanol, propanol, isopropanol, butanol, acetone, diethyl ether, chloroform, tetrachlorination. Carbon, DMSO, DMF, acetonitrile, tetrahydrofuran, toluene, hexane, benzene, sodium hydroxide, sodium hypochlorite, dilute hydrochloric acid, dilute nitric acid, dilute acetic acid.

#### 10.1.2 Pedestal use and maintenance

Immediately after the sample is measured, wipe off the liquid on the pedestal. If the test is finished, clean the pedestal with pure water and dry it so that the solution or solvent does not damage the pedestal.

Do not expose to any form of hydrogen fluoride (HF), which will dissolve the silica fibers in the pedestal.

Do not allow any liquid to enter the gap between the pedestal and the body, as this may damage the machine. If any liquid overflows, please erase it immediately.

If the liquid on the pedestal is not wiped in time after the sample is tested, or after the instrument has been used for a long time, there may be residual impurities such as the sample and its oxides on the surface of the pedestal.

1. Use pure water to remove impurities such as sample residues and oxides on the surface of the optical fiber head of the pedestals. The steps are as follows:

- 1) Add 3-5ul of pure water to the metal surface of the optical fiber at the bottom base,
- 2) Put the flip cover down to form a liquid column and let it stand for 2-3 minutes,
- 3) Wipe clean water with a clean, lint-free cloth.

2. In the case where pure water does not effectively remove the residue on the surface of the pedestal, please use dilute hydrochloric acid (0.5M / L) to remove impurities such as sample residues and sample oxides on the surface of the optical fiber head of the pedestals. The steps are as follows:

- 1) Add 3-5ul of dilute hydrochloric acid (0.5M / L) to the metal surface of the optical fiber at the bottom pedestal,
- 2) Put the flip cover down to form a liquid column and let it stand for 2-3 minutes,
- 3) Wipe the diluted hydrochloric acid with a clean, lint-free cloth.

Note: After removing the impurities on the surface of the optical fiber head with dilute hydrochloric acid (0.5M / L), be sure to use pure water to remove the dilute hydrochloric acid residue on the surface.

### 10.2 Machine use and maintenance

Be sure to read the user manual carefully before use.

Check for electric leakage protection for the first time using and every six months.

Avoid direct sunlight.

Avoid blowing the wind when working, so as not to affect the accuracy.

Try to avoid using it in a humid environment.

Always wipe the instrument surface with a clean soft cloth to keep it clean. It is strictly forbidden to use corrosive cleaning agents.

In case of abnormal situation, please record the process and phenomenon in details, and contact the manufacturer in time.

## Hangzhou Lifereal Biotechnology Co., Ltd.

Address: The 4th Floor, Building A, Jin Niu Zuo, XiXi Software Park,  
No.8 Gao Shun Rd., Yuhang District, Hangzhou, 310023, China.



+86-571-89170228/88733231/88735312



[overseas1@lifereal.com.cn](mailto:overseas1@lifereal.com.cn),  
[overseas2@lifereal.com.cn](mailto:overseas2@lifereal.com.cn),  
[overseas3@lifereal.com.cn](mailto:overseas3@lifereal.com.cn)