

Citotest Pipette Tips Drawing:

Pipette tip size:10uL

Item number: 4330-6136 /4330-7136/ 4330-9136

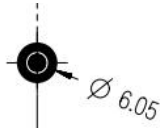

Pipette tip size:10ul (Extended)

Item number: 4330-6162/4330-7162/4330-9162

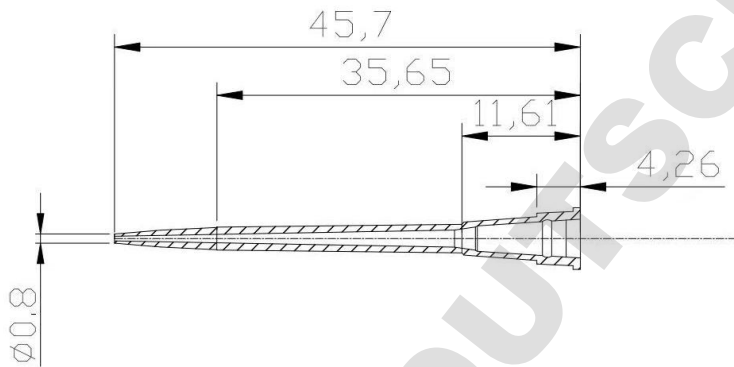

Pipette tip size:20uL/100ul/200ul (same size)

Item number: 4330-7139 /4330-9139 (20ul);

4330-7141/ 4330-9141 (100ul)

4330-6144-17/ 4330-7144 / 4330-9144 (200ul)

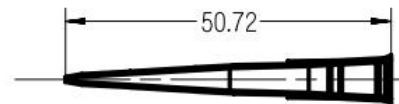
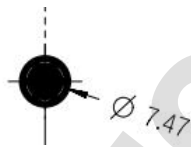

Pipette tip size: 1000ul

Item number: 4330-6152-02 /4330-7152/4330-9152

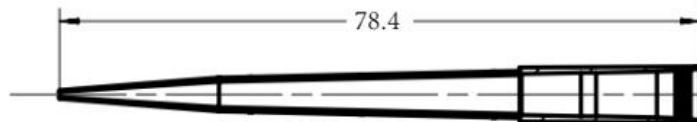
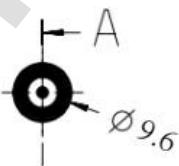

Pipette tips size: 1000ul (extended)

Item number: 4330-6155 (1250ul)

4330-7155/4330-9155

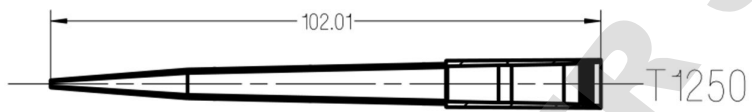
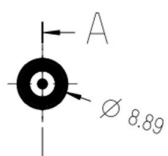

DOMINIQUE DUTSCHER SAS