

PRODUCT DATA SHEET

Erlenmeyer Flasks



125mL Erlenmeyer Flasks

Description: 125mL, Plain Bottom, with Plug Seal Cap or Vent Cap, Sterile

Purpose: Ideal for shaker culture applications and storage

Materials

Flask: PETG (Polyethylene Terephthalate Glycol)/PC (Polycarbonate)

Cap: HDPE (High-density Polyethylene)

Membrane: 0.22µm Hydrophobic (Only use for Vent Cap)

Features

- Temperature range for PC Flasks: -80°C to +121°C
- Temperature range for PETG Flasks: -60°C to +60°C
- Polycarbonate provides excellent optical clarity and mechanical strength
- Crystal-clear PETG is robust and break resistant, increasing personal safety
- Unlike glass, flasks will not break when dropped
- Molded-in graduations for accuracy
- Available with plug seal cap or vent cap
- Vent cap option for continuous gas exchange while ensuring sterility and preventing leakage
- Individually packaged
- non-cytotoxic
- DNase/RNase free and non-pyrogenic
- Sterilized by ebeam or gamma irradiation SAL10⁻⁶ (ISO11137)
- Shelf Life: 3 years after month of production
- Manufactured in a class 100,000 room environment
- Manufactured under ISO13485 and ISO9001 quality management system

Dimensions (Unit:mm)

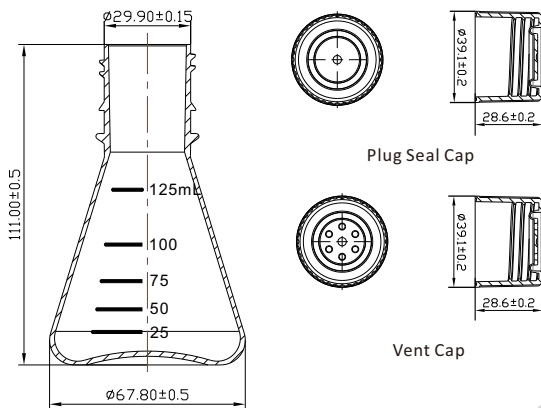

STERILE R

125mL Erlenmeyer Flasks

Cat. No.	Capacity (mL)	Flask Material	Flask Color	Cap Style	Cap Color	Sterilization	Packaging Configuration
TAB001125	125mL	PC	Clear	Plug Seal Cap	Green	Yes	1/PK, 24/CS
TAB002125	125mL	PC	Clear	Vent Cap	Green	Yes	1/PK, 24/CS
TAB101125	125mL	PETG	Clear	Plug Seal Cap	Green	Yes	1/PK, 24/CS
TAB102125	125mL	PETG	Clear	Vent Cap	Green	Yes	1/PK, 24/CS

Drawn	Approved
Date 23 Sep 2021	Date 23 Sep 2021
Name Alex Fang	Name James