

# SERVICE MANUAL

## Overhead Stirrers

---

OS20-S/Pro  
OS40-S/Pro



VERSION20170204

## CONTENTS

Chapter 1: Working Principle .....	1
1.1 Introduction .....	1
1.2 Structure.....	2
Chapter 2: Removal and Installation of Instrument .....	3
2.1 Removal.....	3
2.2 Main parts illustration.....	5
2.3 Circuit Connections (OS20-Pro&OS40-Pro).....	6
2.4 Replacement of drive board.....	7
2.5 Replacement of Control Modules .....	7
2.6 Replacement of Movement .....	8
2.7 Replacement of Photosensor .....	8
Chapter 3: trouble shooting .....	9
Chapter 4: Test method.....	9
4.1 Check photosensor Module .....	9

DOMINIQUE DUTSCHER SAS

## Chapter 1: Working Principle

### 1.1 Introduction

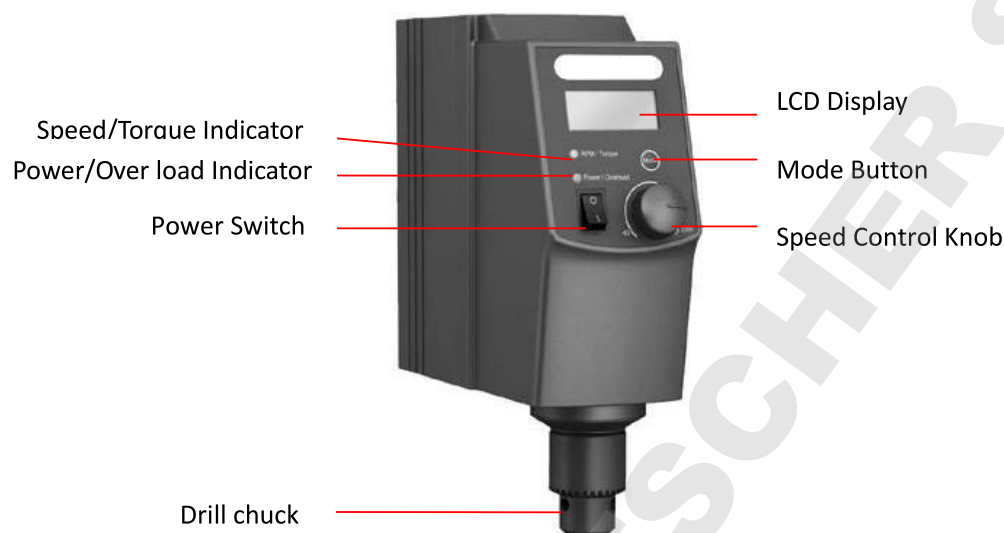

FIG.1

You can mix the sample in container by using Overhead Stirrer with stirring impeller blades. The high viscosity samples can be mixed by using strong stirring force.

Fig. 1 is the schematic diagram of OS40 (20)-Pro Digital Overhead Stirrer. On control panel of the instrument, there are LCD display, mode button, speed control knob, speed/torque indicator, power/overload protection indicator, and power switch. And on the back of instrument, there are RS232 interface and power outlets. After properly connect the power cord and turn on power switch, you can set experimental conditions on the control panel by speed control knob, real-time observe setting values and actual values of parameters on LCD screen.

Stirring impeller is optional. Now, four models are available, and they can mix different concentrations of the samples as tools of OS40 (20)-Pro.

For the control panel settings and functions of various types of Overhead Stirrers,

	speed control knob	LCD display	LED display	RS232 Interface
OS20-Pro	Type I	✓		✓
OS40-Pro	Type I	✓		✓
OS20-S	Type II		✓	
OS40-S	Type II		✓	

Type I Knob: The knob of Digital Overhead Stirrer can be rotated and pressed. There is no stop point when it is rotated. The target parameters are usually set by rotating, and the function is started by pressing;

Type II Knob: The knob of Standard Overhead Stirrer can be rotated. There is a stop point when being rotated and only can be rotated more than half a circle. The target parameters are set by rotating, by which the function is started;

## 1.2 Structure

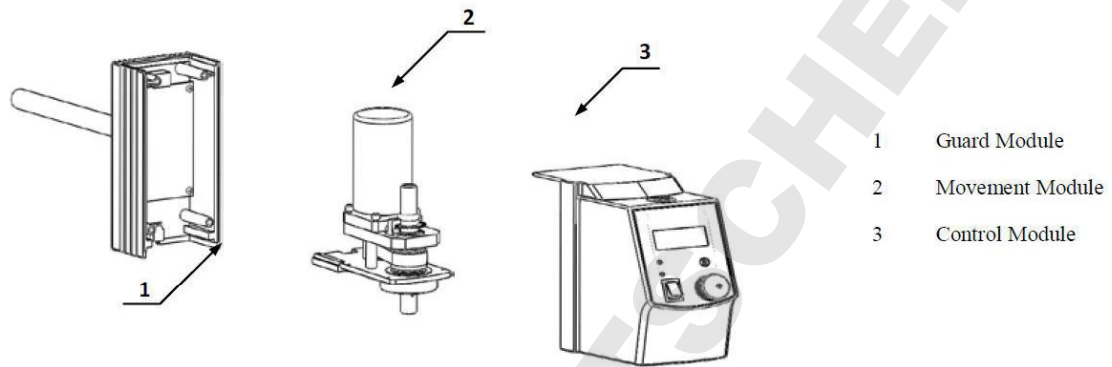

FIG.4

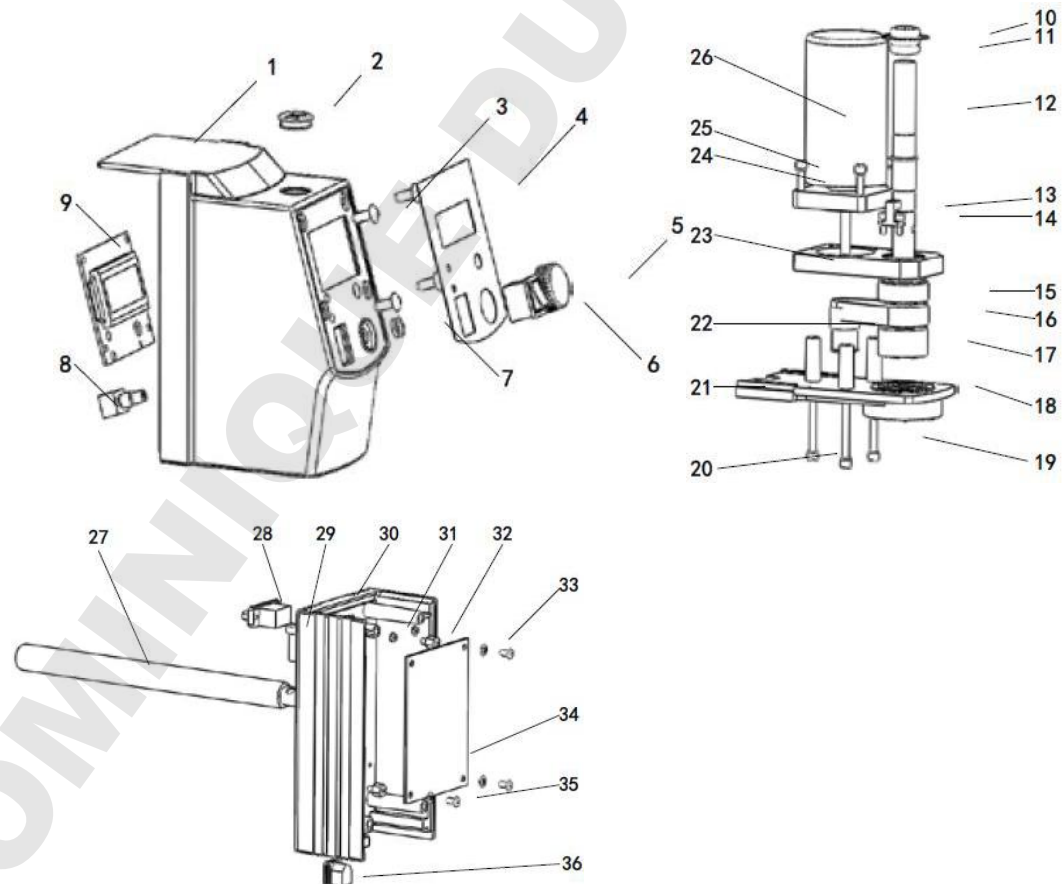

FIG.5

1 Front Guard	2 Rubber Cap	3 Nail	4 Membrane
5 Knob	6 Power Switch	7 Knob Lock	8 Knob Switch
9 Master Control Board	10 Coded Disc	11 Rubber Ring	12 Shaft
13 Photoelectric switch	14 M3*10 Socket Hexagon Screw	15 Bearing	16 Belt
17 Spindle Pulley	18 Bearing	19 M4*35 Socket Hexagon Screw	
20 Ø 4 Elastic Pad	21 Lower Support Plate	22 Motor Pulley	23 Motor Bearing Support
24 M4*15 Socket Hexagon Screw		25 Ø 4 Elastic Pad	26 Motor
27 Rail	28 RS232 Interface	29 M5*16 Socket Hexagon Screw	
30 Rear Guard	31 M3 Hexagon Nut	32 M3*6 Copper Stud	33 Ø Ceramic Gaskets
34 Driven Board	35 M3*6 Pan Head Screw	36 Power Outlet	

Fig. 4 illustrates the structural components of OS40 (20)-Pro, and Fig. 5 is the Exploded View of OS40 (20)-Pro. Guard module includes front guard, Membrane, knob, power switch, rubber cap, LCD PCB, knob switch, and PCB clamp and so on. Control modules are consisted of rear guard, Driven Board, power outlet, RS232 interface and bar and so on. The movement module is composed of motor, coded disc, shaft, motor pulley, bearing pulley, bearing, belt, photoelectric switch, lower support plate and so on.

- ✓ Stirring: Motor drives shaft to rotate through pulley, and further the shaft drives stirring impeller fixed on it to rotate. Thus, the target sample is stirred.
- ✓ Speed feedback: the motor speed is accurately measured by the coded disc fixed on the Shaft along with photoelectric switch and a feedback is given. (OS40(20)-Pro)
- ✓ LCD display: LCD PCB is connected to Driven Board and displays user's settings and current equipment operation information.(OS40(20)-Pro)

## Chapter 2: Removal and Installation of Instrument

When instrument failure occurs, first, you should conduct a failure analysis; if the failure is caused by the damage of instrument hardware, the related component must be repaired or replaced. Here are the relevant contents of the replacement and disassembly of instrument.

### 2.1 Removal

Tool: Cross screwdriver



Step 1:

Turn over the instrument, remove the four screws marked red circles and keep them to be properly preserved. Remove the screws marked green circles at the back of the instrument and keep them to be properly preserved.

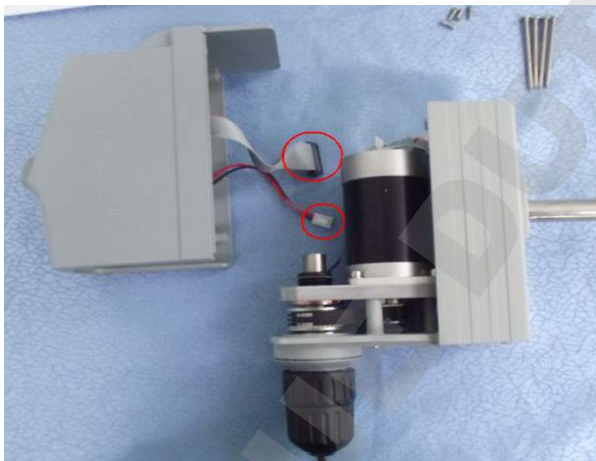
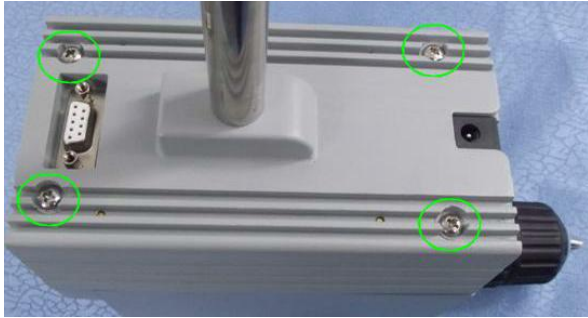

Step 2:

Separate the front and rear guard, and respectively pull out cables marked by red circle.

The front and rear guard are placed at the positions as shown in the Fig., and conduct a analysis on the failure.



Step 3:

Remove the 4 screws marked by red circles and keep them well.

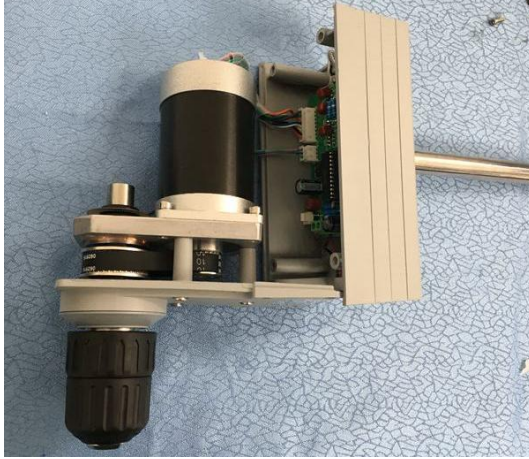

Step 4:

Separate the guard module and movement module.

## 2.2 Main parts illustration

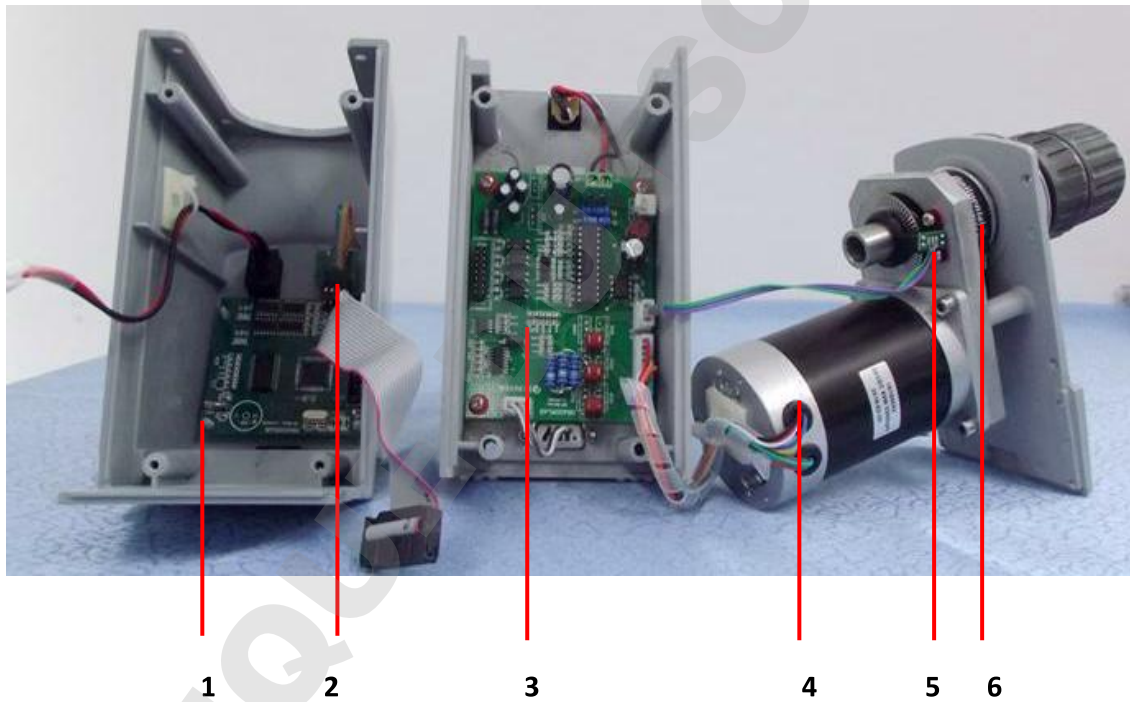

Item	Spare part	OS20-Pro	OS20-S	OS40-Pro	OS40-S
1	Master Control Board	18100472	18101620	18100472	18101620
2	Encoder/potentiometer	18100483	18100489	18100483	18100489
3	Driven Board	18100651	18101619	18100473	18101619
4	Motor	18100493	18100493	18100492	18100492
5	photoelectric switch	18100484	/	18100484	/
6	Belt	18200630	18200630	18200630	18200630

### 2.3 Circuit Connections (OS20-Pro&OS40-Pro)



Step 1:

Circuit connections are performed at the red circle. Before close the upper guard and install instrument, please carefully check the cables and make sure they are correctly connected.

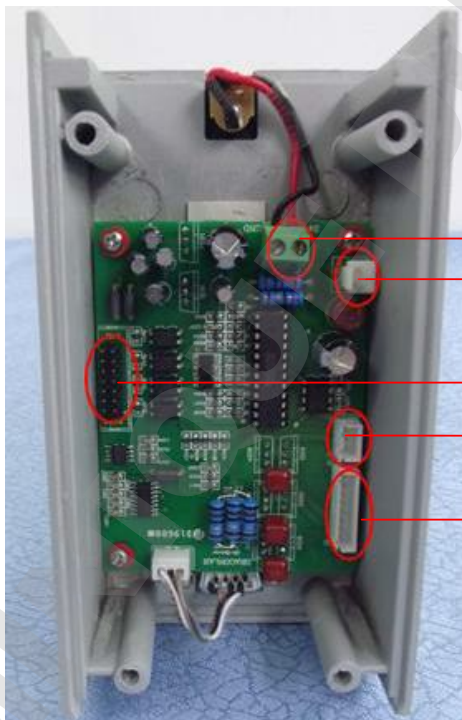

Power Interface

Power switch Interface

Ribbon Cable Interface of LCD PCB

Photosensor interface

Motor interface



## 2.4 Replacement of drive board

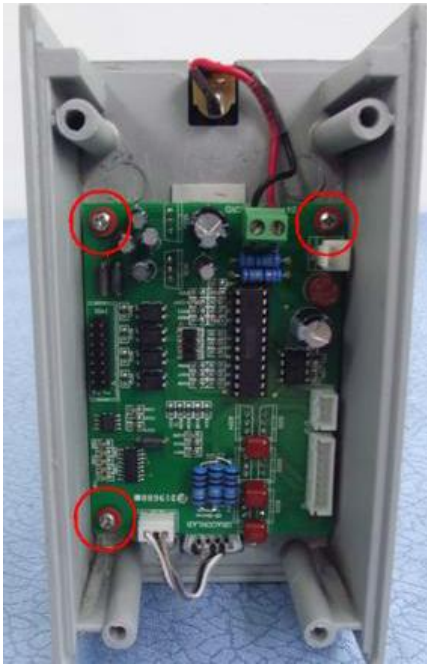

Step 1:

Pull out the cables of Driven Board. Remove the screws and ceramic gaskets (marked in red circles) of fixing Driven Board by tools and keep them to be properly preserved;

Step 2:

Turn over the old Driven Board to be removed, and remove thermal silicagel pads on the Driven Board, to affix it to the corresponding position on the new PCB control board. Pay special attention that the silicagel pads must completely cover the corresponding components. Then carry on circuit connections and tighten

## 2.5 Replacement of Control Modules

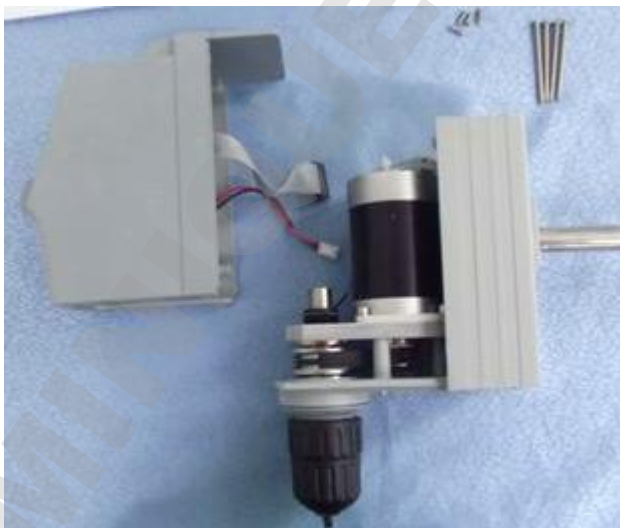

Step 1:

Pull out the cables of control modules and Driven Board after the removal of the instrument; replace new control modules, and tighten screws after the cables are connected;

## 2.6 Replacement of Movement

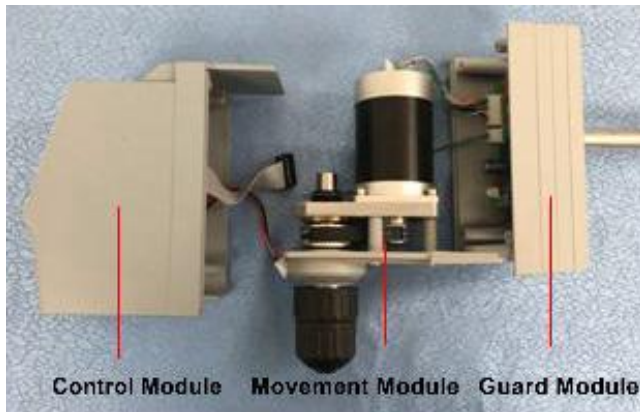

Step 1:

Remove the cables of movement module and guard module. Remove the screws of movement module and guard module at the bottom of the instrument for retention. Re-assemble the instrument after new movement module is replaced.

## 2.7 Replacement of Photosensor

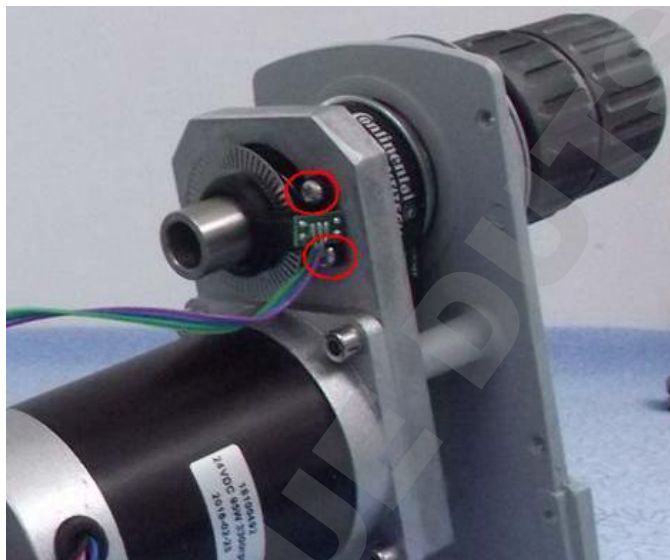

Step 1:

Remove the screws (marked red circles) by tools and keep them to be properly preserved. When you replaced new photosensor, the coded disc on the motor must match with photosensor. When motor is running, coded disc cannot be frictional contact with photosensor. After fine-tuned the position of coded disc, fasten it with screws.

### Chapter 3: trouble shooting

FAULT CODE	PROBLEM	CAUSE	SOLUTION
E01	No operation response (LED off)	No power supply	Check and connect the power supply, then power on again
		The power switch put off	Put on the power switch
		Some cable Connection is failure	As shown in the chapter 2.1 open the instrument and check all the connection, re-connect.
E03	Instrument doesn't stir	No setting target speed	make sure that you have rotated the speed control knob to set a target speed, and the knob is pressed to start stirring
		Some cable Connection is failure	Make sure all the connections are firmly plugged.
		The belt is broken	Replace a new belt
		The driven board is failure	Replace a new driven board
		The photosensor is failure	Replace a new photosensor
E05	Speed control doesn't accurate	Drill Chuck is failure	Replace a new drill chuck
		The photosensor is failure	Replace a new photosensor

### Chapter 4: Test method

#### 4.1 Check photosensor module



As shown in the figure, check if coded disc and the rubber ring on it are synchronously rotating with the shaft; if not, you should fix them with adhesive at the place where parts contact each other. Check whether the photosensor PCB is disordering. If it is, please replace the photosensor. Check the relative position of photosensor and coded disc. Coded disc should lie in the middle of photosensor notch, and coded disc cannot be contact with photosensor

As shown in the figure, check if coded disc and the rubber ring on it are synchronously rotating with the

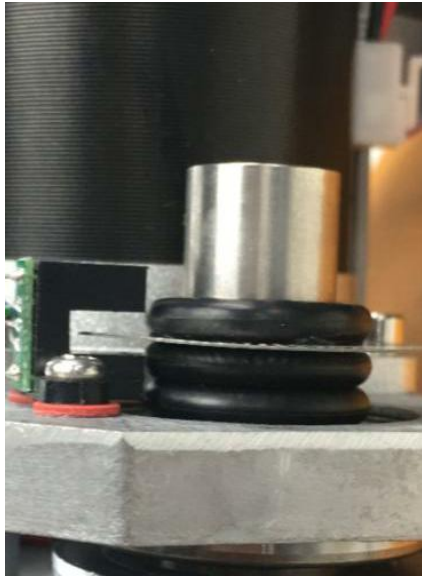

shaft; if not, you should fix them with adhesive at the place where parts contact each other. Check whether the photosensor PCB is disordering. If it is, please replace the photosensor. Check the relative position of photosensor and coded disc. Coded disc should lie in the middle of photosensor notch, and coded disc cannot be contact with photosensor

DOMINIQUE DUTSCHER