

# Corning® CoolBox™ Ice-free Systems

CORNING

Corning CoolBox ice-free systems are bench-top cooling workstations that provide sample cooling or freezing without ice, electricity, or batteries.

CoolBox systems feature a reusable internal cartridge that provides hours of 0.5°C to 4.0°C cooling or -20°C to 0°C freezing.

CoolBox systems are versatile—they accommodate a variety of sample formats and temperatures, including being used with dry ice to create a portable snap-freezing station.



## How It Works

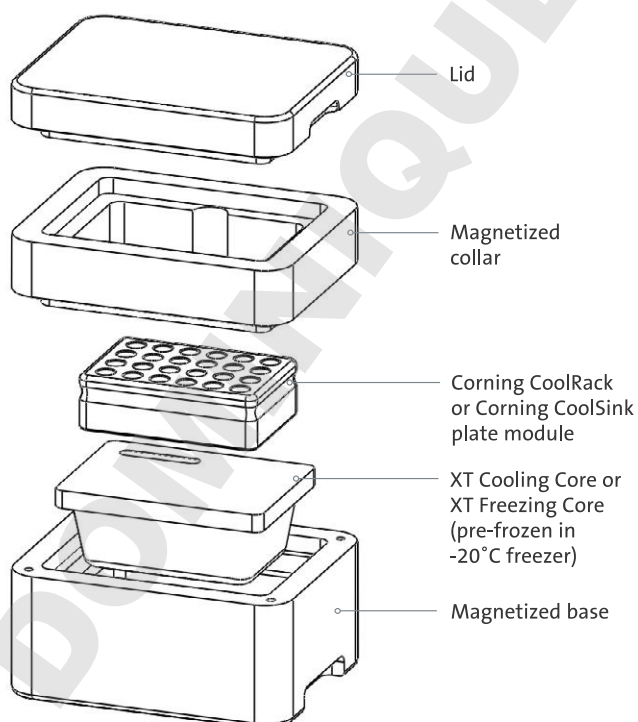

- ▶ Freeze the XT Cooling Core in -20°C freezer
- ▶ Place frozen core in the base
- ▶ Rest the Corning CoolRack® or Corning CoolSink® module on the core (purchase separately)
- ▶ Module will equilibrate and maintain temperature via thermo-conductivity

## Corning® CoolBox™ XT Cooling Core Performance

Over 10 hours with lid open, over 16 hours with lid closed

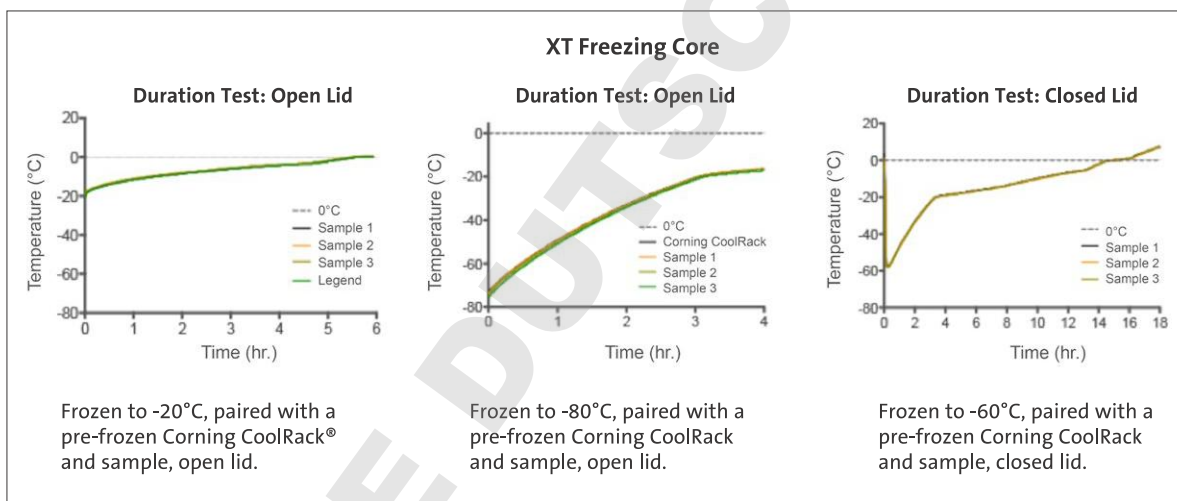
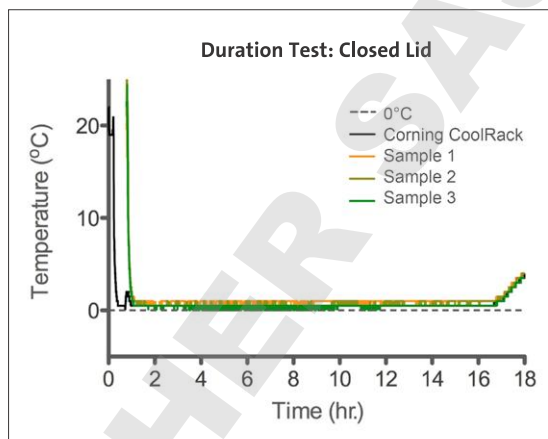
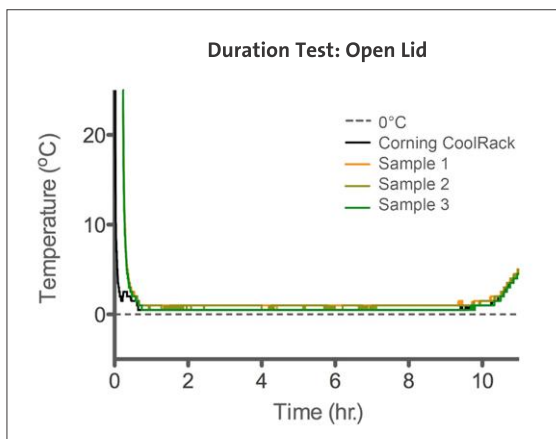

## Choose Your Corning CoolBox System



XT Starter











Corning CoolBox XT and 2XT

	XT Starter	Corning CoolBox XT and 2XT
Holds tubes	Yes	Yes
Holds plates	Yes	Yes
0.5°C to 4°C cooling with lid open	4 hours	10 hours
0.5°C to 4°C cooling with lid closed	N/A	16 hours
<0°C freezing with lid open	N/A	5 hours
<0°C freezing with lid closed	N/A	8 hours

## Ordering Information

### Corning® CoolBox™ Ice-free Systems

	Size	External Dimensions	Internal Dimensions	Corning Cat. No.				
				Purple	Lime Green	Orange	Pink	Blue
	XT Starter, complete	16.2 x 12.1 x 6.1 cm	–	432014	–	–	–	–
	XT Starter Holder only	16.2 x 12.1 x 6.1 cm	–	432015	–	–	–	–
	XT Freezing Core, 0.5°C to 4°C	–	–	–	–	–	–	432081
	XT Freezing Core, below 0°C	–	–	–	–	–	–	432082
	Corning CoolBox XT	20.0 x 16.0 x 15.0 cm	14.0 x 9.4 x 9.9 cm*	432021	432022	432023	432024	–
	XT Extension Collar	20.0 x 16.0 x 7.0 cm	14.0 x 9.4 x 7.0 cm	432083	432084	432085	432086	–
	Corning CoolBox 2XT	26.5 x 20.0 x 15.0 cm	21.0 x 14.3 x 13.4 cm*	432025	432026	432027	432028	–
	2XT Extension Collar	26.5 x 20.0 x 7.0 cm	21.0 x 14.3 x 7.0 cm	432087	432088	432089	432090	–

\*Internal height of open space when core is in the base.

### Corning Cryogenic Vial Grippers

Cryogenic vial grippers feature a unique design to grasp internal or external-thread cryogenic vials. Grippers enable easy sorting and moving of vials while maintaining sterility and protecting fingers from frozen vials, dry ice, and liquid nitrogen.



Cat. No.	Description
432136	Cryogenic vial grippers, multi-color (5/cs)

Contact your Corning Account Manager for a copy of the Corning CoolBox and CoolRack® Consumable Compatibility Guide.

For more specific information on claims, visit the Certificates page at [www.corning.com/lifesciences](http://www.corning.com/lifesciences).

**Warranty/Disclaimer:** Unless otherwise specified, all products are for research use only. Not intended for use in diagnostic or therapeutic procedures. Corning Life Sciences makes no claims regarding the performance of these products for clinical or diagnostic applications.

# CORNING

## Corning Incorporated Life Sciences

836 North St.  
Building 300, Suite 3401  
Tewksbury, MA 01876  
t 800.492.1110  
t 978.442.2200  
f 978.442.2476

[www.corning.com/lifesciences](http://www.corning.com/lifesciences)

## ASIA/PACIFIC

**Australia/New Zealand**  
t 61 427286832

**China**  
t 86 21 3338 4338  
f 86 21 3338 4300

**India**  
t 91 124 4604000  
f 91 124 4604099

## Japan

t 81 3-3586 1996  
f 81 3-3586 1291

## Korea

t 82 2-796-9500  
f 82 2-796-9300

## Singapore

t 65 6572-9740  
f 65 6735-2913

## Taiwan

t 886 2-2716-0338  
f 886 2-2516-7500

## EUROPE

CSEurope@corning.com

## France

t 0800 916 882  
f 0800 918 636

## Germany

t 0800 101 1153  
f 0800 101 2427

## The Netherlands

t 020 655 79 28  
f 020 659 76 73

## United Kingdom

t 0800 376 8660  
f 0800 279 1117

## All Other European Countries

t +31 (0) 206 59 60 51  
f +31 (0) 206 59 76 73

## LATIN AMERICA

grupoLA@corning.com

## Brasil

t 55 (11) 3089-7400

## Mexico

t (52-81) 8158-8400

For additional product or technical information, visit [www.corning.com/lifesciences](http://www.corning.com/lifesciences) or call 800.492.1110. Outside the United States, call +1.978.442.2200 or contact your local Corning sales office.