

Corning® CoolCell® Containers



Corning CoolCell alcohol-free cell freezing containers ensure a standardized controlled-rate of freezing of $-1^{\circ}\text{C}/\text{minute}$ cell freezing in a -80°C freezer—without alcohol or any fluids. CoolCell cryogenic containers are proven for use with a variety of cell types including stem cells, primary cells, PBMC, cell lines, insect cells, yeast, and others. The proprietary Corning CoolCell technology utilizes a thermo-conductive alloy core and highly-insulative outer material to control the rate of heat removal and provide reproducible cell cryopreservation. CoolCell units are easy to use and deliver results comparable to expensive programmable freezers at a fraction of the cost.

Features

- ▶ Ease of use
- ▶ Alcohol and fluid-free freezing
- ▶ Lower cost of use than alcohol-based devices
- ▶ Available in purple, green, orange, and pink.



Better than IPA



Corning CoolCell Container	Isopropanol (IPA) Container
No alcohol <ul style="list-style-type: none"> • No fluids • No pre-cooling • Saves 12L/unit of IPA per year 	Requires isopropanol <ul style="list-style-type: none"> • Replace alcohol after every 5 uses • Track number of uses • Pre-cool alcohol in refrigerator
No variability <ul style="list-style-type: none"> • All vials have uniform freeze rate • Radially symmetric design ensures vial consistency 	Inconsistent freeze rate <ul style="list-style-type: none"> • Alcohol degradation induces variability • Two circles of wells; two freeze rates
No on-going cost <ul style="list-style-type: none"> • No alcohol purchase or disposal 	Approximately \$350/year <ul style="list-style-type: none"> • Change alcohol weekly • Hazardous waste disposal
No stuck lids <ul style="list-style-type: none"> • Ergonomic lid comes off easily when frozen • Not cold to the touch when removing from the -80°C freezer 	Difficult to handle <ul style="list-style-type: none"> • Screw cap is difficult to remove when frozen • Frozen unit is slippery and cold to the touch
Quick re-use time <ul style="list-style-type: none"> • Ready to use again after five minutes 	Wait between runs <ul style="list-style-type: none"> • Takes >1 hour for the alcohol to warm-up

Corning CoolCell Reproducibility

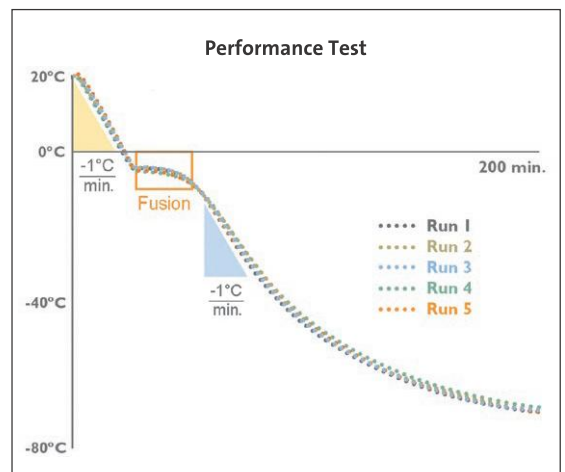

A temperature probe was placed into a 2.0 mL cryogenic vial containing 1.0 mL of water, and the tube was inserted into a room temperature Corning CoolCell. The CoolCell was placed into a -80°C freezer, and the temperature rate and profile was recorded over a 3-hour period. The test was repeated 5 consecutive times. Corning CoolCell generated identical fusion time and cooling profiles over five consecutive freeze cycles.

Corning® CoolCell® Performance vs. IPA Container

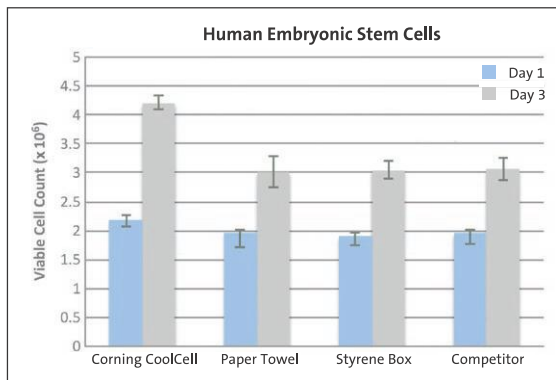

Human embryonic stem cells, RC-10, were frozen using the technique indicated, thawed after 2 weeks in LN₂, and counted immediately (Day 1) or after 3 days of growth (Day 3).

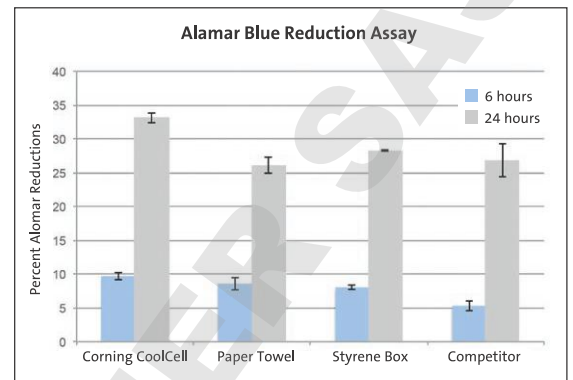

Alamar blue reduction assay for proliferation assessment showed cells frozen in the Corning CoolCell container grew quicker, leading to more total cells.

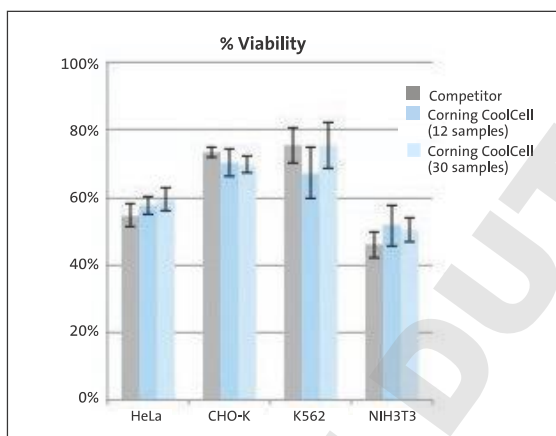

Corning CoolCell 12-well, CoolCell FTS30 30-well, or competitor freezing containers were used to freeze all four cell lines. Identical transfection efficiencies and viabilities were observed after thawing.

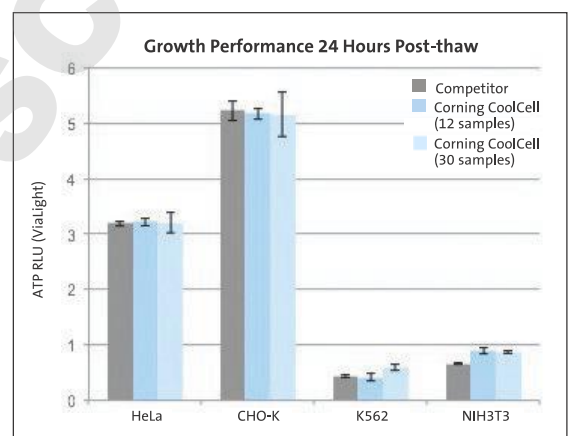

Identical growth of cells was observed 24 hours post-thaw.

Corning CoolCell Performance vs. Programmable Freezer

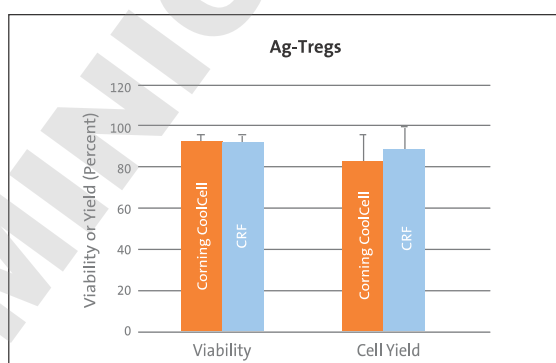

Effects of freezing on antigen-specific Treg (Ag-Treg) cell therapy products; Ag-Tregs (n = 6) were frozen at concentration of 1 to 10 x 10⁶ cells/mL using the Corning CoolCell freezing device or controlled-rate freezer (CRF) with a freezing rate of -1°C/min. Viability and absolute viable cell count of thawed Ag-Treg cell therapy products were evaluated by flow cytometry. (Data generated by TxCell SA)

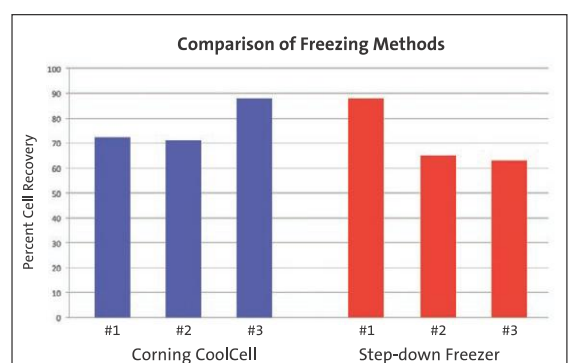

Graph comparing percent of cell recovery after freezing with the Corning CoolCell freezing device (blue) versus freezing using a programmable step-down freezer (red) in 3 different samples at high cell concentration. There was no significant difference between the two freezing methods. (Data generated by UCSF Diabetes Center)

How Corning® CoolCell® LX Works

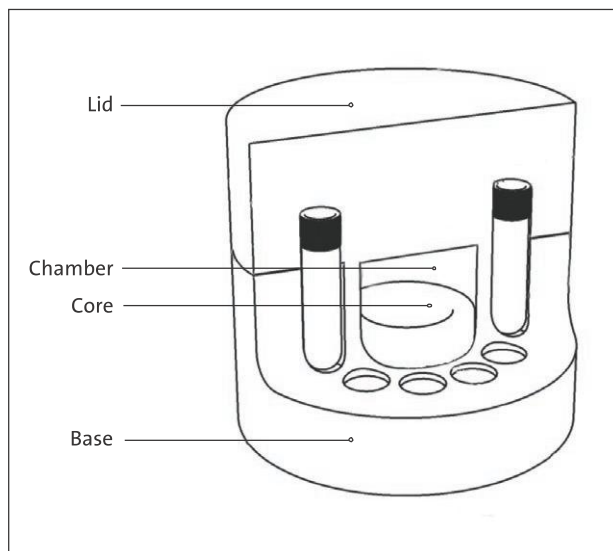

Corning CoolCell LX uses a combination of uniform-density cross-linked polyethylene foam, a solid state core, and radial vial symmetry to create freezing profiles that are consistent and reproducible. The low heat content also ensures that CoolCell LX containers will rapidly return to room temperature when removed from the freezer.

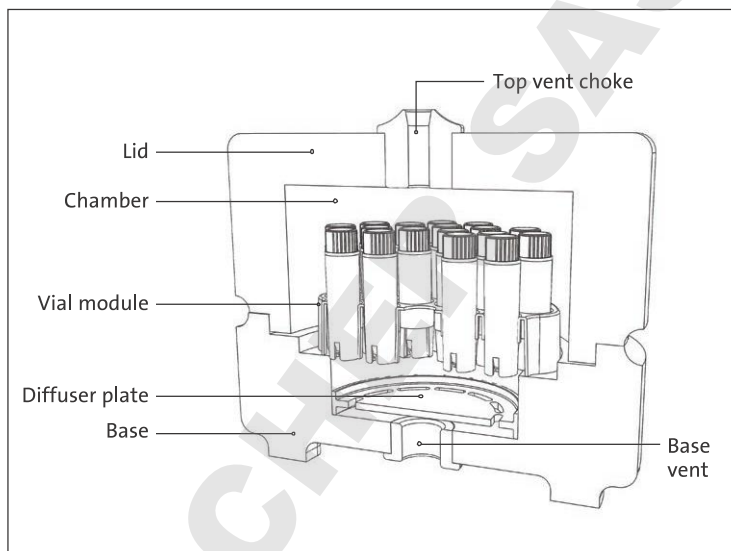

Corning CoolCell FTS30 uses a solid state core and controlled micro-convection technology to evenly draw in -80°C freezer air through a bottom base vent, uniformly disperse the cold air around each vial in the central chamber and then release the thermal load from the vials through a top vent choke. The inner vial module holds 30 cryogenic vials and can be removed in one step. Each vial achieves a uniform and reproducible $-1^{\circ}\text{C}/\text{minute}$. Freezing profile and thermal profiles are highly reproducible. Due to the low thermal mass of the uniform-density cross-linked polyethylene foam container, freezing can be conducted without a rise in local freezer temperature, thereby protecting nearby samples.



Ordering Information

Corning® CoolCell® Containers

Cat. No.	Description	External Dimension (Diameter x Height)	Well Diameter
432000	Corning CoolCell, purple	11.7 x 10.9 cm	12.7 mm
432001	Corning CoolCell LX, purple	11.7 x 9.9 cm	12.7 mm
432002	Corning CoolCell LX, green	11.7 x 9.9 cm	12.7 mm
432003	Corning CoolCell LX, orange	11.7 x 9.9 cm	12.7 mm
432004	Corning CoolCell LX, pink	11.7 x 9.9 cm	12.7 mm
432138	Corning CoolCell LX 4-pack (all 4 colors)	11.7 x 9.9 cm	12.7 mm
432006	Corning CoolCell FTS30, purple	16.5 x 11.5 cm	12.3 mm
432008	Corning CoolCell FTS30, green	16.5 x 11.5 cm	12.3 mm
432007	Corning CoolCell FTS30, orange	16.5 x 11.5 cm	12.3 mm
432009	Corning CoolCell FTS30, pink	16.5 x 11.5 cm	12.3 mm
432005	Corning CoolCell 5 mL LX, purple	9.5 x 14.5 cm	15.2 mm
432010	Corning CoolCell SV2, purple	13.9 x 10.5 cm	14.7 mm
432011	Corning CoolCell SV10, purple	12.1 x 9.8 cm	23.6 mm



To ensure cell freezing rate consistency and uniform results when using Corning CoolCell containers, insert a CoolCell Filler Vial into the empty wells when freezing less than a full load. It is suitable for repeated use and compatible with CoolCell LX, CoolCell FTS30, and CoolCell 5 mL LX containers.

Cat. No.	Description	For Use With
432076	Corning Corning CoolCell filler vial, 2 mL, 6/pk	Corning CoolCell LX, CoolCell FTS30
432077	Corning Corning CoolCell filler vial, 5 mL, 6/pk	Corning CoolCell 5 mL LX
432078	Removable cryogenic vial module for CoolCell FTS30	Corning CoolCell FTS30



Corning Cryogenic Vial Grippers

Cryogenic vial grippers feature a unique design to grasp internal or external-thread cryogenic vials. Grippers enable easy sorting and moving of vials while maintaining sterility and protecting fingers from frozen vials, dry ice, and liquid nitrogen.

Cat. No.	Description
432136	Cryogenic vial grippers, multi-color (5/cs)

For more specific information on claims, visit the Certificates page at www.corning.com/lifesciences.

Warranty/Disclaimer: Unless otherwise specified, all products are for research use only. Not intended for use in diagnostic or therapeutic procedures. Corning Life Sciences makes no claims regarding the performance of these products for clinical or diagnostic applications.

For additional product or technical information, visit www.corning.com/lifesciences or call 800.492.1110. Outside the United States, call +1.978.442.2200 or contact your local Corning sales office.

CORNING

Corning Incorporated
Life Sciences

836 North St.
Building 300, Suite 3401
Tewksbury, MA 01876
t 800.492.1110
t 978.442.2200
f 978.442.2476

www.corning.com/lifesciences

ASIA/PACIFIC

Australia/New Zealand
t 61 427286832

China
t 86 21 3338 4338
f 86 21 3338 4300

India
t 91 124 4604000
f 91 124 4604099

Japan

t 81 3-3586 1996
f 81 3-3586 1291

Korea

t 82 2-796-9500
f 82 2-796-9300

Singapore

t 65 6572-9740
f 65 6735-2913

Taiwan

t 886 2-2716-0338
f 886 2-2516-7500

EUROPE

CSEurope@corning.com

France
t 0800 916 882
f 0800 918 636

Germany
t 0800 101 1153
f 0800 101 2427

The Netherlands
t 020 655 79 28
f 020 659 76 73

United Kingdom
t 0800 376 8660
f 0800 279 1117

All Other European Countries

t +31 (0) 206 59 60 51
f +31 (0) 206 59 76 73

LATIN AMERICA

grupoLA@corning.com

Brasil
t 55 (11) 3089-7400

Mexico
t (52-81) 8158-8400