



# BradyPrinter i5300

User Manual

---

## Copyright and Trademarks

### Disclaimer

This manual is proprietary to Brady Worldwide, Inc. (hereafter “Brady”), and may be revised from time to time without notice. Brady disclaims any understanding to provide you with such revisions, if any.

This manual is copyrighted with all rights reserved. No portion of this manual may be copied or reproduced by any means without the prior written consent of Brady.

While every precaution has been taken in the preparation of this document, Brady assumes no liability to any party for any loss or damage caused by errors or omissions or by statements resulting from negligence, accident, or any other cause. Brady further assumes no liability arising out of the application or use of any product or system described, herein; nor any liability for incidental or consequential damages arising from the use of this document. Brady disclaims all warranties of merchantability of fitness for a particular purpose.

Brady reserves the right to make changes without further notice to any product or system described herein to improve reliability, function, or design.

### Trademarks

BradyPrinter™ i5300 is a trademark of Brady Worldwide, Inc.

Microsoft, Windows, Excel, Access and SQL Server are registered trademarks of Microsoft Corporation.

All brand or product names referenced in this manual are trademarks (™) or registered trademarks (®) of their respective companies or organizations.

© 2021 Brady Worldwide, Inc. All Rights Reserved.

Y4950335

Revision A

Brady Worldwide, Inc.  
6555 West Good Hope Road  
Milwaukee, WI 53223  
[bradyid.com](http://bradyid.com)

---

## Brady Warranty

Our products are sold with the understanding that the buyer will test them in actual use and determine for themselves the adaptability to their intended uses. Brady warrants to the buyer that its products are free from defects in material and workmanship, but limits its obligation under this warranty to replacement of the product shown to Brady's satisfaction to have been defective at the time Brady sold it. This warranty does not extend to any persons obtaining the product from the buyer.

THIS WARRANTY IS IN LIEU OF ANY OTHER WARRANTY, EXPRESS OR IMPLIED, INCLUDING, BUT NOT LIMITED TO, ANY IMPLIED WARRANTY OF MERCHANTABILITY OR FITNESS FOR A PARTICULAR PURPOSE, AND OF ANY OTHER OBLIGATIONS OR LIABILITY ON BRADY'S PART. UNDER NO CIRCUMSTANCES WILL BRADY BE LIABLE FOR ANY LOSS, DAMAGE, EXPENSE OR CONSEQUENTIAL DAMAGES OF ANY KIND ARISING IN CONNECTION WITH THE USE, OR INABILITY TO USE, BRADY'S PRODUCTS.

## Safety and Environment

Please read and understand this manual before using the BradyPrinter™ i5300 printer for the first time. This manual describes all of the main functions of the BradyPrinter™ i5300 printer.

### Precautions

Before using the BradyPrinter™ i5300 printer, please note the following precautions:

- Read all instructions carefully before operating the printer and prior to performing any procedure.
- Do not place the unit on an unstable surface or stand.
- Do not place anything on top of the unit.
- Keep the top clear of obstructions.
- Always use the printer in a well ventilated area. Do not block the slots and opening on the unit, which are provided for ventilation.
- Only use the power source indicated on the rating label.
- Use only the power cord that comes with the unit.
- Do not place anything on the power cord.

---

## Technical Support and Registration

### Contact Information

For repair or technical assistance, locate your regional Brady Technical Support office by going to:

- **United States:** [bradyid.com/techsupport](http://bradyid.com/techsupport)
- **Canada:** [bradycanada.ca/contact-us](http://bradycanada.ca/contact-us)
- **Mexico:** [bradyid.com.mx/es-mx/contacto](http://bradyid.com.mx/es-mx/contacto)
- **Latin America:** [bradylatinamerica.com/es-mx/soporte-técnico](http://bradylatinamerica.com/es-mx/soporte-técnico)
- **Europe:** [bradyeurope.com/services](http://bradyeurope.com/services)
- **Australia:** [bradyid.com.au/technical-support](http://bradyid.com.au/technical-support)
- **Asia Pacific:** [brady.co.uk/landing-pages/global-landing-page](http://brady.co.uk/landing-pages/global-landing-page)

### Registration Information

To register your printer go to:

- [bradycorp.com/register](http://bradycorp.com/register)

### Repair and Return

If for any reason you need to return the product for repair, please contact Brady Technical Support for repair and replacement information.

## Document Conventions

When using this document, it is important that you understand the conventions used throughout the manual.

- All user actions are indicated by **Bold** text.
- References to menus, windows, buttons and screens are indicated by *Italicized* text.

# Contents

## 1 • Introduction

|                                     |          |
|-------------------------------------|----------|
| <b>Features and Functions</b> ..... | <b>1</b> |
| <b>Compatible Software</b> .....    | <b>2</b> |
| <b>System Specifications</b> .....  | <b>2</b> |

## 2 • Setup

|  |           |
|--|-----------|
| <b>Unpacking the Printer</b> .....                     | <b>3</b>  |
| What's in the Box .....                                | 3         |
| Registration .....                                     | 3         |
| <b>Printer Components</b> .....                        | <b>4</b>  |
| Exterior .....   | 4         |
| Interior .....   | 5         |
| <b>Power</b> .....                                     | <b>6</b>  |
| Setup .....  | 6         |
| Power Save Mode .....                                  | 6         |
| Put the Printer into Sleep Mode .....                  | 7         |
| Wake the Printer from Sleep Mode .....                 | 7         |
| Reboot the Printer .....                               | 7         |
| <b>Software for Creating Labels</b> .....              | <b>8</b>  |
| <b>Connecting the Printer</b> .....                    | <b>8</b>  |
| Ethernet Network .....                                 | 8         |
| Wi-Fi .....  | 9         |
| <i>Search to Connect</i> .....                         | 9         |
| <i>Manually Enter Settings</i> .....                   | 10        |
| USB .....  | 10        |
| <b>Installing the Windows Driver (Optional)</b> .....  | <b>11</b> |
| <b>Install or Change Supplies</b> .....                | <b>11</b> |
| Compatible Label Supplies and Ribbons .....            | 11        |
| Ribbon .....   | 11        |
| Label Supplies .....                                   | 13        |
| <b>Printer Settings</b> .....                          | <b>16</b> |
| Language .....   | 16        |
| Keyboards .....  | 17        |
| Units of Measure .....                                 | 17        |
| Date and Time .....                                    | 18        |
| Storage Location .....                                 | 18        |
| Print on Demand .....                                  | 18        |
| Printer Name .....                                     | 19        |
| <b>Recycling the Label and Ribbon Cartridges</b> ..... | <b>20</b> |
| Dismantling the Ribbon Cartridge .....                 | 21        |
| <i>Recycling Components</i> .....                      | 22        |
| Dismantling the Label Cartridge .....                  | 23        |

|   |           |
|---|-----------|
| <i>Recycling Components</i> .....           | 24        |
| <b>3 • General Operation</b>                |           |
| <b>Using the Touchscreen</b> .....          | <b>25</b> |
| Navigation and Status Bar .....             | 26        |
| Material Details .....                      | 26        |
| <b>Creating Labels</b> .....                | <b>26</b> |
| <b>Storing Files on the Printer</b> .....   | <b>27</b> |
| <b>Printing Labels</b> .....                | <b>27</b> |
| Printing from Software .....                | 27        |
| Printing from the Printer .....             | 28        |
| Feeding and Cutting Labels .....            | 28        |
| Printing Double-Sided Sleeves .....         | 28        |
| <b>Using the Print Screen</b> .....         | <b>30</b> |
| <b>Using the File List</b> .....            | <b>31</b> |
| Searching, Sorting, and Filtering .....     | 32        |
| <b>Using the Print Queue</b> .....          | <b>33</b> |
| Adding Files to the Queue .....             | 33        |
| Removing Files From the Queue .....         | 33        |
| Change the Print Order .....                | 34        |
| <b>Adjusting Print Settings</b> .....       | <b>34</b> |
| Print Speed .....                           | 34        |
| Print Energy .....                          | 34        |
| Print Position .....                        | 35        |
| Cutting Options .....                       | 35        |
| BPL Scripts .....                           | 35        |
| <i>Print Orientation</i> .....              | 35        |
| <i>Mirror Print</i> .....                   | 36        |
| Print on Demand .....                       | 36        |
| <b>External Hardware</b> .....              | <b>36</b> |
| <b>4 • Using Scripts</b>                    |           |
| <b>Graphics &amp; Fonts</b> .....           | <b>37</b> |
| Import .....                                | 37        |
| Delete .....                                | 38        |
| <b>Running a Script</b> .....               | <b>38</b> |
| <b>5 • Maintenance</b>                      |           |
| <b>Displaying System Information</b> .....  | <b>39</b> |
| <b>Installing Firmware Upgrades</b> .....   | <b>39</b> |
| <b>Updating Y and B Values</b> .....        | <b>40</b> |
| <b>Cleaning the Printer</b> .....           | <b>40</b> |
| Cleaning Dust and Debris from Printer ..... | 40        |
| Cleaning the Printhead .....                | 41        |
| Cleaning the Print Roller .....             | 42        |
| Cleaning the Sensors .....                  | 43        |

|   |           |
|---|-----------|
| Cleaning the Cutter Blade .....                                   | 45        |
| Cleaning the Cutter Blade Exit Area .....                         | 47        |
| Cleaning the Display .....  | 48        |
| <b>Clearing Jams .....</b>  | <b>48</b> |
| Printer Jam .....   | 48        |
| Cutter Jam .....  | 49        |
| <b>Replacing the Supply Wiper .....</b>                           | <b>51</b> |
| <b>Replacing the Printhead.....</b>                               | <b>52</b> |
| <b>Replacing the Print Roller.....</b>                            | <b>54</b> |
| <b>6 • Troubleshooting</b>  |           |
| <b>A • Regulatory Compliance</b>                                  |           |
| <b>Agency Compliance and Approvals .....</b>                      | <b>60</b> |
| United States .....   | 60        |
| <i>FCC Notice .....</i>   | <i>60</i> |
| Canada .....  | 60        |
| Mexico .....  | 60        |
| Europe .....  | 61        |
| <i>RoHS Directive 2011/65/EU, 2015/863/EU .....</i>               | <i>61</i> |
| <i>Batteries Directive 2006/66/EC .....</i>                       | <i>61</i> |
| Turkey .....  | 61        |
| China .....   | 62        |
| Taiwan .....  | 62        |
| <b>Wireless Regulatory Information .....</b>                      | <b>62</b> |
| United States .....   | 63        |
| Canada .....  | 63        |
| Mexico .....  | 64        |
| Brazil .....  | 64        |
| European Union .....  | 64        |
| International .....   | 64        |
| Japan .....   | 64        |
| <b>B • Licensing</b>  |           |
| <b>End User License Agreement for Microsoft Windows CE© .....</b> | <b>65</b> |

# 1 Introduction

---

Use the BradyPrinter™ i5300 Sign and Label Printer to create and print professional-looking industrial labels and signs. All you have to do is:

- Insert a ribbon cartridge. You can choose from a wide range of single-color ribbons.
- Insert a label cartridge.
- Send labels for printing from your labeling software.

Labels and ribbons from Brady Corporation communicate with Brady software. This saves time and label waste by eliminating the need for calibration and for trial and error speed and energy adjustments.

## Features and Functions

The following are just some of the features that make this system so easy to use and ready to meet your label-making requirements:

- Fast, high volume printing.
- No wasted labels because no calibration is required.
- Complete supply changeover in less than 20 seconds.
- Built-in automatic cutter.
- Sturdy and rugged desktop construction (29.8 pounds)
- Color touchscreen LCD display input.
- Single-color job printing on 300 dpi or 600 dpi models, up to 4 in. (101.6 mm) wide and up to 60 in. (1.5 m) long.
- Continuous and die-cut label supplies in a variety of high-performance materials.
- Transfer graphics from PC or USB flash drive. Supported graphic formats are bitmap (\*.bmp), JPG file (\*.jpg), Graphic Interchange Format (\*.gif) and Portable Network Graphics (\*.png).
- Print labels from PC.
- Run scripts directly from a USB drive.

BradyPrinter™ i5300 supports ZPL, jScript, DPL and BPL. For the list of supported commands, please visit [www.BradyID.com/i5300](http://www.BradyID.com/i5300).

## Compatible Software

The BradyPrinter™ i5300 printer is compatible with Brady® Workstation desktop label creation software and other Windows-based label creation software.

When used with Brady Workstation software, no driver installation is required and the software automatically recognizes the installed label supply and ribbon making label creation easier and faster. The printer driver is required if using third-party software. See “*Installing the Windows Driver (Optional)*” on page 11 and the documentation for your software.

## System Specifications

- **Weight:** 29.8 lbs (13.5 kg)
- **Dimensions (stored):** 15.7 in. x 11.1 in. x 11.2 in. (40 cm x 28.2 cm x 28.5 cm)
- **Operating Temperature:** 50 - 104°F (10-40°C)
- **Relative Humidity:** 10% to 80% RH non-condensing
- **Storage:** -4 to 122°F (-20 to 50°C) at 15% to 90% RH non-condensing
- **Voltage:** 100-240 VAC 50/60 Hz, 3.5A
- **Print Resolution:** 11.8 dots/mm for 300 dpi models, 23.6 dots/mm for 600 dpi models.
- **Output label size:** 0.25 in. to 4.015 in. (6.4 mm to 102 mm)
- **Maximum label length (continuous):** 60 in. (1.5 m)
- **Print speed:**
  - 300 dpi model: 1-10 ips depending on label supply
  - 600 dpi model: 1-5 ips depending on label supply

## 2 Setup

---

### Unpacking the Printer

Carefully unpack and inspect the printer surfaces (interior and exterior) and the labeling system for possible damage during shipping.

**Note:** Be sure to remove any transportation protection from around the printhead and inside the enclosure cover.

#### What's in the Box

- BradyPrinter™ i5300 printer
- Free Brady Workstation label creation software (booklet includes download instructions and license key)
- USB drive including: Quick Start Guide, User Manual, driver, and video tutorial.
- Power Cord
- USB Type B Cable
- Printed "Quick Start Guide"
- Cleaning Kit

**Note:** Please keep the original packaging, including the box, in case the printer must be returned.



**CAUTION!** If shipping the printer, consult with your transportation carrier for state, federal, municipal, and international shipping regulations regarding the lithium ion battery contained in the printer.

#### Registration

Register your printer online at [www.bradycorp.com/register](http://www.bradycorp.com/register) and receive free product support and updates!

## Printer Components

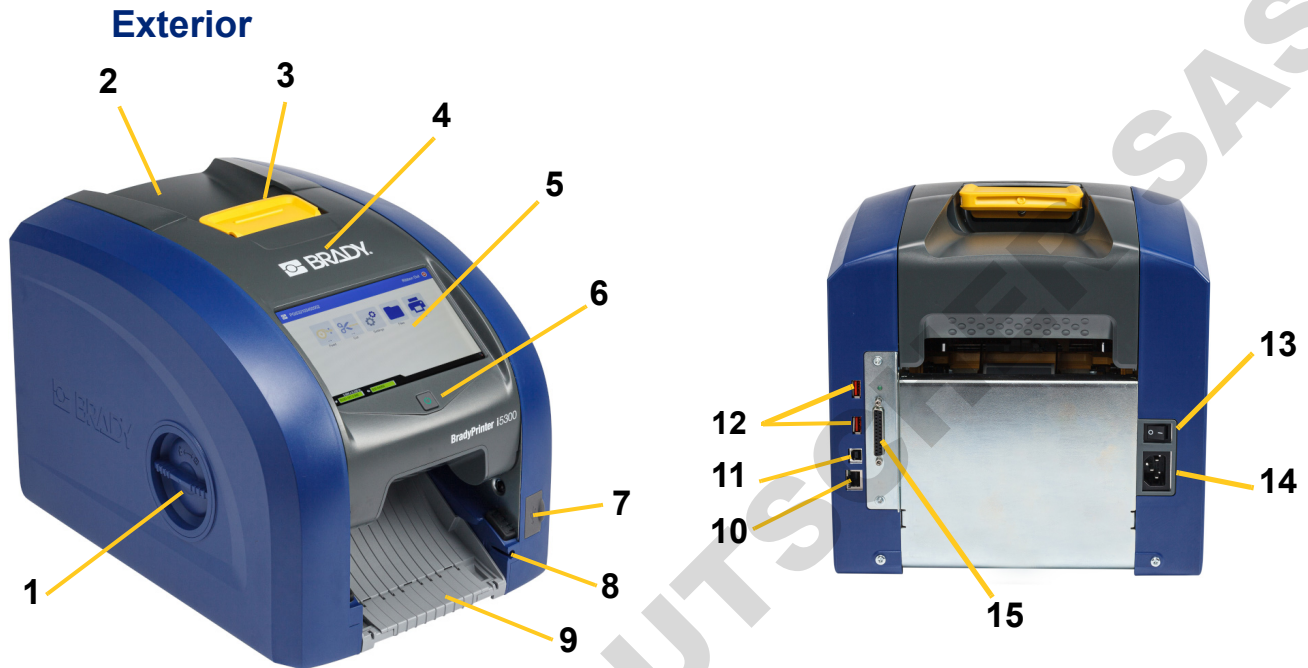

- |   |  |    |                                 |
|---|--|----|---------------------------------|
| 1 | Roller access hatch (for print roller replacement) | 9  | Exit chute (with label catcher) |
| 2 | Rear cover   | 10 | Ethernet port                   |
| 3 | Latch for ribbon door                              | 11 | USB-B port (to computer)        |
| 4 | Ribbon door  | 12 | USB-A ports                     |
| 5 | Touchscreen  | 13 | Power switch                    |
| 6 | Sleep button                                       | 14 | AC power cord port              |
| 7 | USB-A port   | 15 | IO port                         |
| 8 | Stylus storage slot                                |    |                                 |

**Note:** The printer is equipped with a universal power supply and can be operated with a voltage of 100 to 240 V~, 50- to 60 Hz. The printer senses the voltage type and automatically adjusts for the power source.

**Interior**

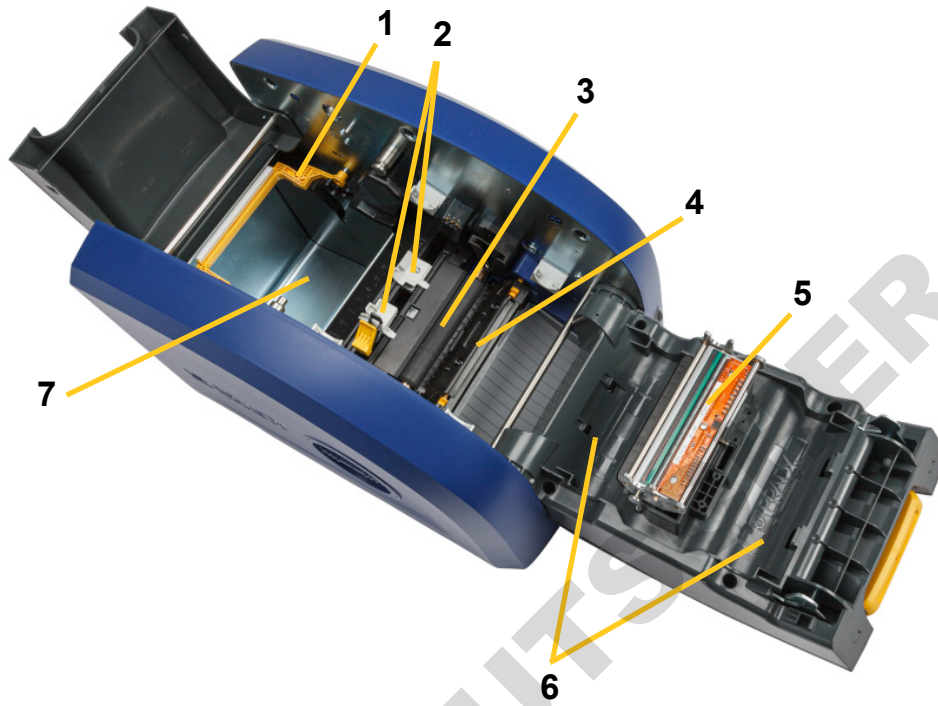

- |   |                                 |   |               |
|---|---------------------------------|---|---------------|
| 1 | Supply wiper arm (shown raised) | 5 | Printhead     |
| 2 | Label supply guides             | 6 | Ribbon holder |
| 3 | Rubber print roller             | 7 | Label well    |
| 4 | Cutter                          |   |               |

## Power

### Setup

To connect power and turn on the printer:

1. Plug the power cord into the printer at the location shown.

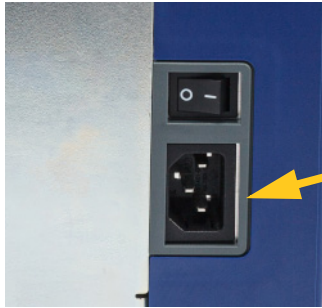

2. Plug the other end of the power cord into an AC power outlet.
3. Turn the power switch on. The printer turns on and displays the home screen. The first time you turn on the printer it walks you through configuring the settings. Follow the instructions on the touchscreen.



### Power Save Mode

When the printer is plugged in, you can leave it in a state of readiness all the time so that software can find the printer. Or you can choose to conserve power so that the printer automatically goes to sleep after a period of inactivity.

To set the inactive period:

1. Make sure the printer is turned on.
2. Tap **Settings**  .
3. Press **System Configuration > Power Save Mode**.
4. Choose **AC Power**.

- Slide the time indicator dot left (decrease) or right (increase) for the amount of inactive time that can elapse before the printer automatically shuts down. Alternatively you can press the minus (-) button to decrease or the plus (+) button to increase the time.
- Tap  to return to the home screen.

## Put the Printer into Sleep Mode

When the system is asleep the display turns off and the system goes into a low power consumption state but does not require a cold start to turn back on. In this state, you can either touch the screen or press the power button to return the system to the same state it was in before going into lower power consumption mode. When the printer is in sleep mode the power button is lit green.

**Note:** To fully shut down the printer, use the power switch on the back.

### To put the printer to sleep:

With the printer on, press the sleep button.



## Wake the Printer from Sleep Mode

If you do not touch the screen or keypad for a defined period of time, the system turns off the display and goes into a low-power consumption mode. When in Sleep Mode, the power button is lit green. The current label and settings are retained.

### To wake the printer:

- Press the sleep button or touch the screen.
- Continue with your label activities.



## Reboot the Printer

### To reboot the printer:

- Press and hold the sleep button for at least 5 seconds. The system performs the initialization process and starts the printer.



- When the home screen displays, you can continue with your label activities.

## Software for Creating Labels

Install labeling software on your computer, set up the connection to the printer, then use the software to design labels and send them to the printer.

Brady Workstation software provides a variety of apps to simplify label creation for specific purposes. It also provides easy-to-use apps for custom label design. The printer comes with a license for the Brady Workstation Product & Wire Identification Suite.

### To install the Product & Wire Identification Suite:

1. Make sure your computer is connected to the internet.
2. Go to [workstation.bradyyid.com/PWID](http://workstation.bradyyid.com/PWID).
3. Follow the instructions on the screen to download and install the software.
4. When you run the software and open an app that requires activation, follow the instructions on the screen to activate the software. Use the license ID and password on the printed insert that came with the printer.

For other Brady Workstation software or additional licenses, go to [www.workstation.bradyyid.com](http://www.workstation.bradyyid.com) or contact your Brady representative.

## Connecting the Printer

Connect to a computer in one or more of the following ways:

- Ethernet® network. This method allows multiple computers to send label files to the printer. See below.
- Wi-Fi® wireless network (depending on your printer model). See “*Wi-Fi*” on page 9.
- Directly with a USB cable. See “*USB*” on page 10.

### Ethernet Network

This section describes how to configure the printer to communicate via an Ethernet (TCP/IP) connection.

**Note:** If using a Windows driver (see “*Installing the Windows Driver (Optional)*” on page 11) it is best to configure the Ethernet connection before installing the driver. If the driver is already installed before configuring the Ethernet connection, you may need to edit the port settings for the printer in Windows to update the IP address.

#### To configure Ethernet network settings:

1. On the home screen tap **Settings**.
2. Tap **Connection**.
3. Tap **Advanced Network Settings**.



4. Tap **Ethernet**.
5. Tap **IP Settings**, and then choose either DHCP or Static.
  - **DHCP:** DHCP addressing is dynamic and the system uses a DNS server in the printer IP address for you. No additional fields need to be entered.
  - **Static:** For static addressing, you must supply the printer's IP address. First, tap the back button  to return to the *Ethernet* screen, then fill in the following information. You may need to get assistance from your network administrator.
    - **IP Address:** Enter the printer's IP address.
    - **Subnet Mask:** Enter a subnet mask if you are using one.
    - **Default Gateway:** Enter the IP address of the default gateway.
    - **DNS Server (Primary):** Enter the IP address of the primary DNS server.
    - **DNS Server (Secondary):** Enter the IP address of the secondary DNS server.

**IMPORTANT!** If no DNS server is being used, enter 0.0.0.0 for both the primary and secondary DNS servers.
6. Tap the back button  to return to the *Advanced Network Settings* screen in order for the fields entered to take effect.

## Wi-Fi

Connect to a Wi-Fi network either by searching for and selecting a network or by manually entering the network settings. Once connected, the printer can communicate with computers on that network.

**Note:** Wi-Fi capability is not available on all printers or in all countries.

**IMPORTANT!** Before configuring the Wi-Fi connection on an enterprise network, be sure the printer is set to the current date and time. The printer may not be able to establish the connection if the date and time is not current. See *"Date and Time"* on page 18.

## Search to Connect

**To connect to a Wi-Fi wireless network:**



1. Make sure the printer is turned on.
2. Tap **Settings**. 
3. Tap **Connection**.
4. Tap **Wi-Fi Network** to turn on Wi-Fi. The printer searches for Wi-Fi networks and displays a list of networks found. Touch and drag to scroll the list. (If you need to identify the network by static IP address or DHCP, see *"Manually Enter Settings"* on page 10.) Tap the network that you want to use.
  - If the network is not locked, simply tap it and the printer connects to it.

- If the network is locked, as indicated by a lock symbol, tap the network and a key pad opens. Enter the password and tap .
- **Note:** If your network uses WEP authentication, a menu displays instead so that you can enter both the password and the WEP index (key).
- If the network you need is not in the list, it may not be discoverable. Scroll to the bottom of the list and tap **Other**. Choose either **Personal Network** or **Enterprise Network**. The system displays settings appropriate to your selection. You may need information from your IT department to complete the settings.

### Manually Enter Settings

Use this method for networks that are hidden.

#### To connect to a Wi-Fi wireless network:

1. Make sure the printer is turned on.
2. Tap **Settings**. 
3. On the *Settings* screen, select **Connection**.
4. Tap **Advanced Network Settings**.
5. Select **Wi-Fi** from the list.
6. Tap **IP Settings** and then tap one of the following.
  - **DHCP:** DHCP addressing is dynamic and the system uses a DNS server to obtain the printer IP address for you.
  - **Static:** Select static addressing to manually enter the printer's IP address.
7. Tap the back button to return to the *Wi-Fi* screen. 
8. Fill in the remaining available settings with help from your network administrator.
9. Tap  to return to the home screen.

### USB

To connect to a computer via USB 2.0, plug the provided USB cable into the printer and the computer. Brady Workstation software automatically detects the printer when connected via USB cable.



**Note:** If you are not using Brady Workstation software, you need to install the printer driver. See the *Driver Installation Guide* PDF file on the USB drive that came with the printer.

## Installing the Windows Driver (Optional)

If you are using Brady Workstation software, you do not need to install the windows driver.

You must install the Windows driver if you are using any of the following.

- Older Brady software such as LabelMark.
- Third-party software.
- The Data Automation app in Brady Workstation software.

See the *Driver Installation Guide* PDF file on the USB drive that came with the printer.

## Install or Change Supplies

### Compatible Label Supplies and Ribbons

The BradyPrinter™ i5300 printer accepts only B30- and B33- series label supplies and B30- series ribbon cartridges of version 2 or higher. Compatible parts prominently display **V:2** on the part number label located on both the roll and the box.

Brady label supplies and ribbon cartridges have a smart cell so the printer can automatically recognize the installed label supply and ribbon.

**Note:** The printer can be either on or off when changing supplies.

### Ribbon

**To change or load the ribbon cartridge:**

1. To remove the ribbon, lift the latch to open the ribbon door and swing it open.



2. Press the tab to release the ribbon cartridge, and lift the cartridge up and out.

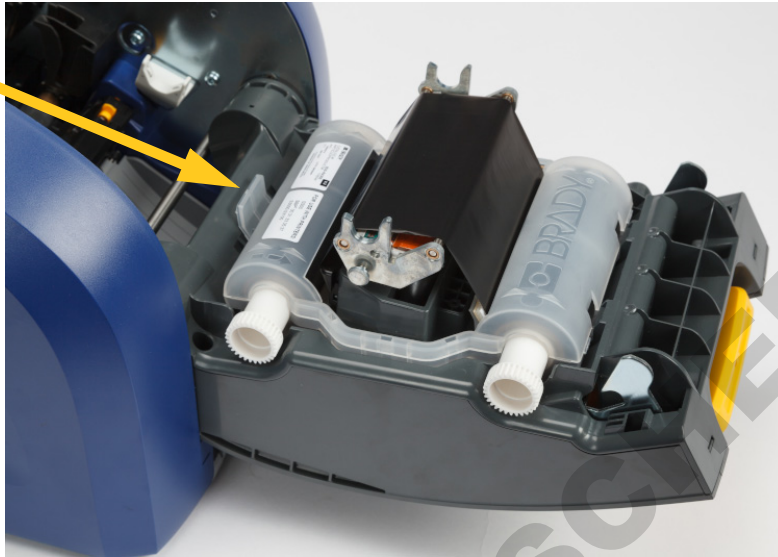

3. Place the ribbon cartridge so that the ribbon is over the printhead and the embossed Brady logo is facing upward. Snap the cartridge into place. You'll hear a click when it is seated properly.
4. Close the ribbon door and press down so that the latch snaps into place.
5. If the printer was asleep, press . The system detects the installed supplies, sets label and ribbon colors, and indicates the label dimensions and the amount of remaining supplies.

## Label Supplies

For information on compatible supplies see “Compatible Label Supplies and Ribbons” on page 11.

To change or load the label roll:

1. Lift the latch to open the ribbon door and swing it open.



2. Open the rear cover.

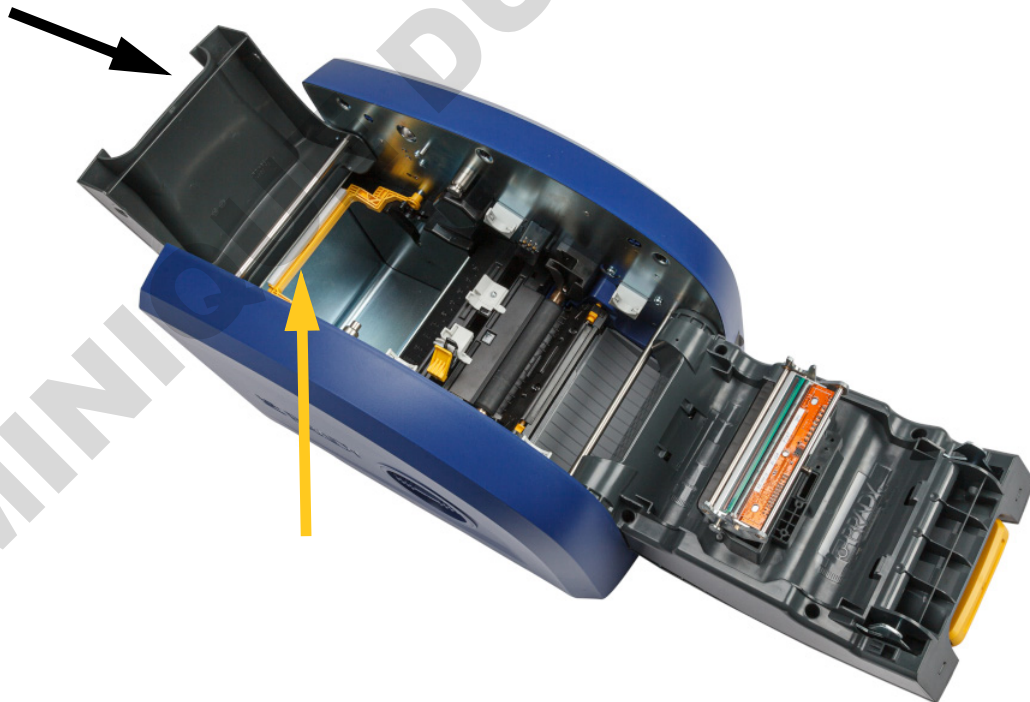

3. Swing yellow supply wiper to the back as show above.

4. Pinch together the yellow and black tabs on the label supply guides and slide them to the fully open position.

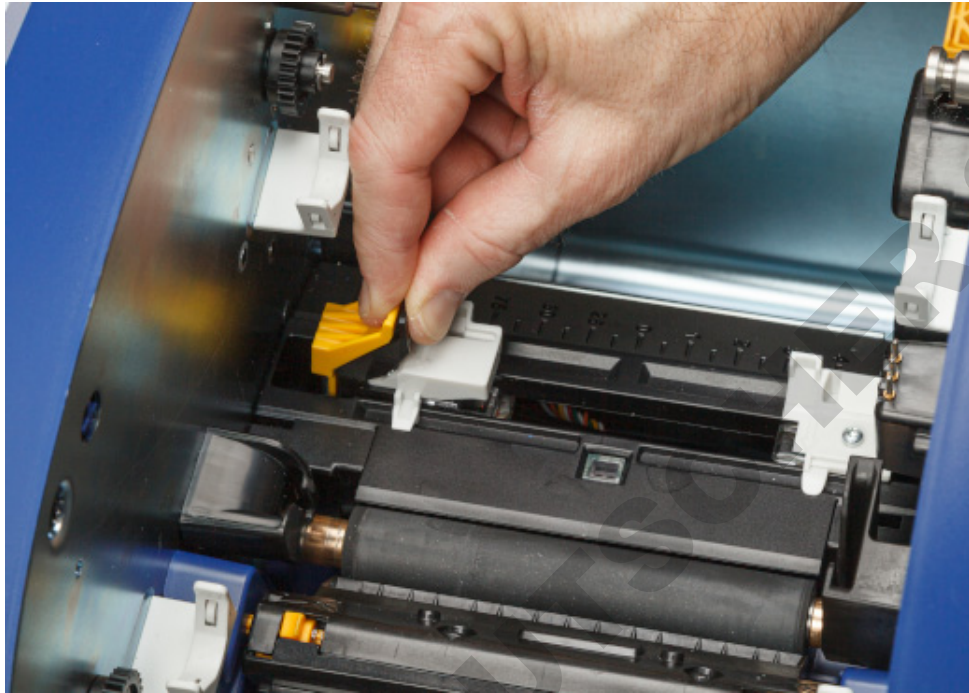

5. Remove the existing supply, if installed. Grasp the label roll and gently pull up out of the label well.
6. Orient the new roll with labels coming off the top of the spool toward the front of the printer and the rabbit ears on the left-hand side. Insert the new roll into the label well. Make sure the smart cell on the label roll aligns with the reader in the label well.

**smart cell**

**reader**

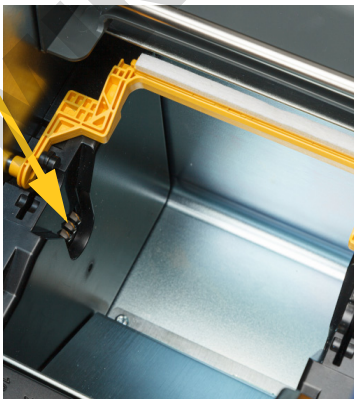

- Pinch together the yellow and black tabs on the label supply guides and slide the guides apart.

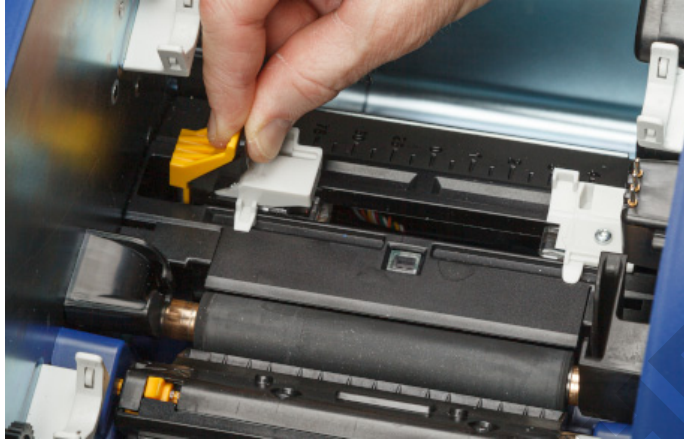

- Pull the leading edge of the labels from the top of the roll until it sits just past the black rubber roller, but no further. For wide labels, be sure to feed them under the label supply guides.

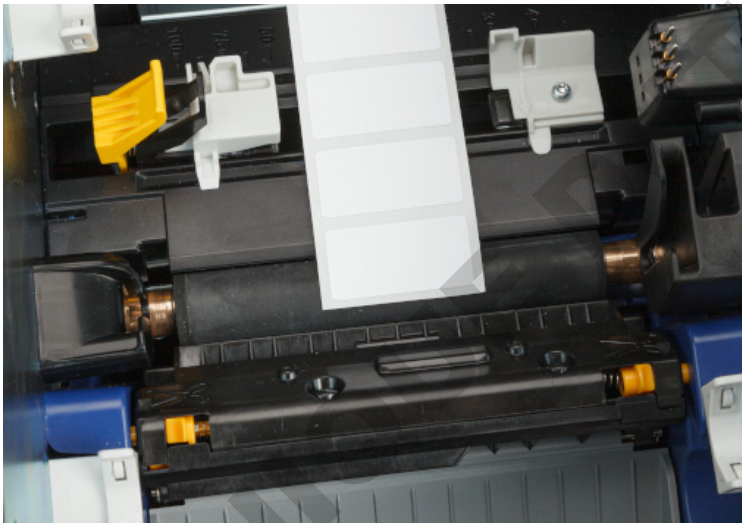

**Correct**

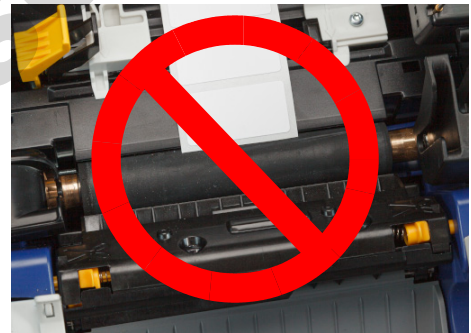

**CAUTION!** Labels can jam in the printer if started too far forward or too far backward.

- Pinch together the yellow and black tabs on the label supply guides and slide the guides together until they touch the edge of the supply liner with the labels under the guides.

- If using a continuous label supply, move the supply wiper into position so it rests on the label. Do not position the wiper on the labels if using a die cut supply.

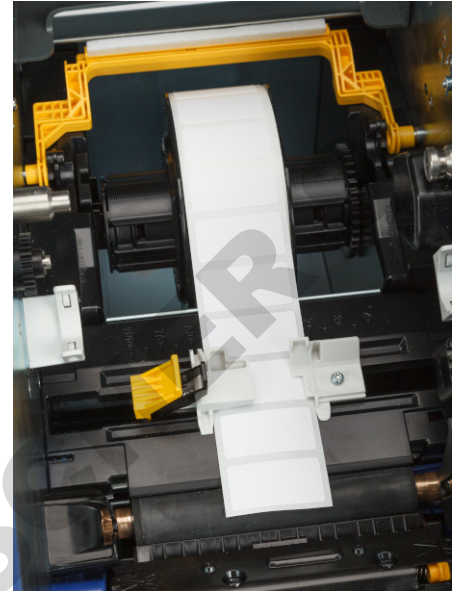
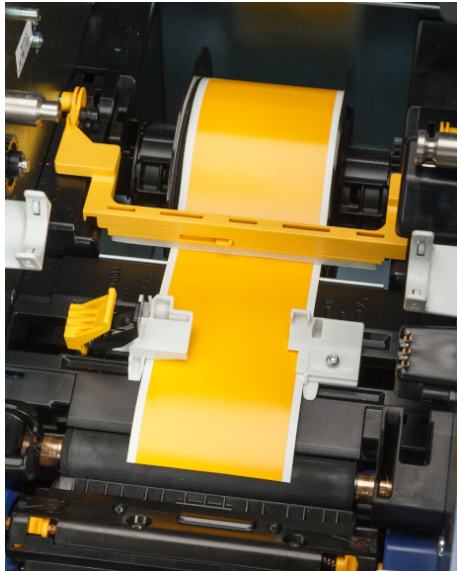

- Close and latch the ribbon door, then close the rear cover.

- If the printer was asleep, press . The system detects the installed supplies, sets label and ribbon colors, and indicates the label dimensions and the amount of remaining supplies.

## Printer Settings

The first time you turn on the printer, instructions on the touchscreen walk you through the settings that must be configured the first time you use the printer. The following sections detail these settings should you need to change them in the future, and provide instruction on a few additional settings to consider when setting up the printer.

For an introduction to using the touchscreen, see *“Using the Touchscreen”* on page 25. For print settings see *“Adjusting Print Settings”* on page 34.

For information on power save mode, see *“Power Save Mode”* on page 6.

### Language

To set the language for text on the touchscreen:

- With the printer turned on, tap **Settings**. 
- Tap **System Configuration**, then **Language**.

3. Tap the desired language. You may need to scroll to see all available languages. Touch the screen and drag your finger up or down to scroll.
4. Tap  to go back to the previous screen.

## Keyboards

The printer displays a keyboard on the screen when you have to type data, such as when you name the printer. Because different languages use different sets of characters, you may need keyboards with different character sets. By default the printer uses the appropriate keyboard for the language setting. For example, if the printer language is set to Simplified Chinese, the printer will automatically display a keyboard with Simplified Chinese characters. If you only want to use the default keyboard, you do not need to change any keyboard settings.

### To select keyboards:

1. From the home screen, tap **Settings**. 
2. Tap **System Configuration**, then **Virtual Keyboard**. A list of supported keyboards is displayed.
3. Tap the check box for each keyboard that you want to have available when using the printer. You can select multiple keyboards. The default keyboard (that for the printer language) is shown at the top of the list and cannot be deselected.

When you use the keyboard later, the default keyboard is shown. Tap the globe icon to switch to a different enabled keyboard. Each time you tap the globe icon, the display switches to another enabled keyboard.





To connect a physical keyboard, see “*External Hardware*” on page 36.

## Units of Measure

Set the unit of measure to inches or millimeters.



### To set the unit of measure:

1. From the home screen, tap **Settings**. 
2. Tap **System Configuration**, then **Measurement Units**.
3. Tap either **Inches** or **Millimeters**.
4. Tap  to go back to the previous screen.

## Date and Time

Set the printer's clock to the current date and time.



To set the date and time:

1. From the home screen, tap **Settings**. 
2. Tap **System Configuration**, then **Date and Time**. The left side of the screen displays the current settings.
3. To change the settings, tap the controls on the right.
  - **Use 24-hour format:** Tap the switch to change between 24-hour format and 12-hour format with AM and PM. When the switch is red, the printer uses 12-hour format. When the switch is green, the printer uses 24-hour format.
  - **Set date:** Tap to display date controls. To change the date, either tap on an element and select a new value, or tap the arrows above or below an element.
  - **Set time:** Tap to display time controls. To change the time, either tap on an element and select a new value, or tap the arrows above or below an element.
4. Tap  to go back to the previous screen.

## Storage Location

Choose whether the printer accesses files from memory or from a USB drive.

To set the storage location:

1. From the home screen, tap **Settings**. 
2. Tap **System Configuration**, then **Storage Location**.
3. Tap the desired value.
  - **Internal Memory:** Choose this option if the printer is directly connected to the computer with a USB cable or on a network. When you print a label from Brady Workstation software and choose the *Store* option, the print file is sent to the printer's internal memory. When you tap *Files* on the home screen, the printer accesses the list of files from internal memory.
  - **External Storage:** Choose this option when transferring files from one BradyPrinter™ i5300 printer to another. Insert a USB drive into the USB port on the printer. When you print a label from Brady Workstation software, the print file is sent to the USB drive. When you tap *Files* on the home screen, the printer accesses the list of files from the USB drive.
4. Tap  to go back to the previous screen.

## Print on Demand

Print on demand causes the printer to wait for input on the touchscreen before printing the next label in the file. When *Print on Demand* is off, all labels in a file are printed without waiting in between.

**To enable print on demand:**

1. From the home screen, tap **Settings**. 
1. Tap **Print Adjustments**.
2. To the right of **Print on Demand**, tap the switch to change the setting. If the switch is red, it is off. If the switch is green, it is on.



When *Print on Demand* is enabled, tapping the yellow start button prints just one label rather than all the labels.

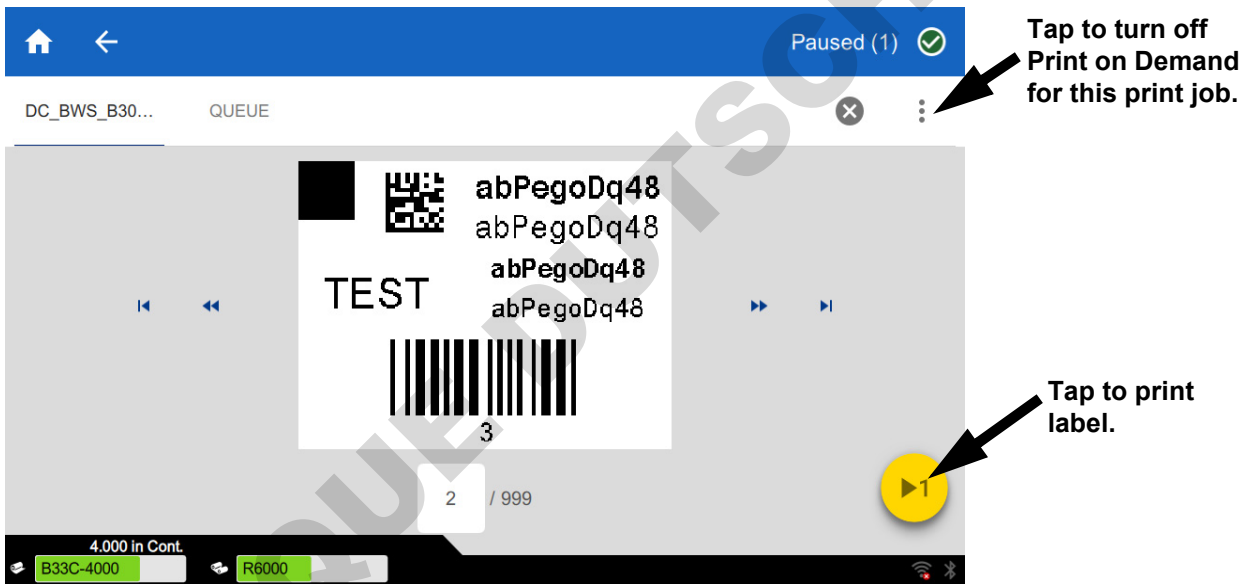

**To override *Print on Demand* and print all remaining labels:**

1. Tap the yellow circle to pause printing.
2. Tap the three dots in the upper right.
3. Turn off *Print on Demand* for this print job.

**Printer Name**

The printer name is displayed when a computer searches for the printer on a Wi-Fi connection.

**To change the printer name:**

1. With the printer turned on, tap **Settings**. 
2. Tap **Connection**, and then tap **Printer Name**. The printer displays a keyboard.

The printer name can only contain the characters A-Z, a-z, 0-9, and -. Regardless of the keyboards you have enabled for your printer, the printer displays a keyboard with the allowed characters.

3. Use the keyboard on the touchscreen to type a name for the printer.
4. When finished tap .

When using Brady Workstation software on Wi-Fi, this name is shown when selecting a printer. See “Software for Creating Labels” on page 8 and “Connecting the Printer” on page 8.

## Recycling the Label and Ribbon Cartridges

Cartridges need to be recycled in accordance with local regulations. Before recycling, the used cartridges must be pulled apart to release the individual components which then must be recycled in the correct recycling bins.

### Materials Required:

- 9/32- inch blade or 1/4-inch blade (ribbon) and 5/32- inch blade (label) flathead screwdrivers
- Safety glasses
- Safety gloves



CAUTION! Always wear personal protective equipment (PPE) when dismantling a cartridge.

## Dismantling the Ribbon Cartridge

### To dismantle the ribbon:

1. Using your thumbnail or the blade of the screwdriver, apply pressure to push the clear plastic locking tabs up until the cartridge unlocks.



2. Insert the blade of the screwdriver next to each tab along the seam of the two halves of the cartridge and gently pry apart the halves.



Repeat this process on both sides of the cartridge until all tabs are disconnected and the cartridge opens.

3. Slide the smart cell out of its location slot.
4. Unwind the ribbon from the spools and peel the ribbon end from the cardboard cores.
5. Remove the ribbon spools from the center of the cardboard core.

**Recycling Components**

These components should be removed from the cartridge and recycled according to the following guidelines.



|   | Component                 | Material   | Recycle Bin      |
|---|---------------------------|------------|------------------|
| 1 | Ribbon Cartridge (opaque) | PP         | #5 PP            |
| 2 | Smart Cell                | Electronic | Electronic Waste |
| 3 | Cardboard Core            | Cardboard  | #20 C PAP        |
| 4 | Ribbon Spools (white)     | ABS        | #6 PS            |

## Dismantling the Label Cartridge

### To dismantle the label cartridge:

1. Using your thumbs, simultaneously apply pressure to the **release tabs** while pushing the center cylinder forward until the tabs release and unlock the center cylinder.
2. Pull the loose cylinder free from the label cartridge.
3. Using the screwdriver, place the blade in the gap next to the **smart cell holder** and pry the holder from the cylinder.
4. Remove the smart cell from the plastic holder.



5. Push the screwdriver blade between the flat cartridge guides and **locking end cap**. Twist the screwdriver and continue this process around the end cap until it comes off.
6. Repeat this process on the other side of the cartridge.
7. Remove the cardboard tube by pushing the center core out from the tube or by cutting the tube off of the core.



**Recycling Components**

These components should be removed from the cartridge and recycled according to the following guidelines.



|   | Component         | Material   | Recycle Bin      |
|---|-------------------|------------|------------------|
| 1 | Cardboard Tube    | Cardboard  | #20 C PAP        |
| 2 | Cartridge Guides  | PC         | #7 PC            |
| 3 | Center Cylinder   | POM        | #7 POM           |
| 4 | Smart Cell Holder | POM        | #7 POM           |
| 5 | Smart Cell        | Electronic | Electronic Waste |
| 6 | Locking End Caps  | POM        | #7 POM           |
| 7 | Center Core       | ABS        | #7 ABS           |

# 3 General Operation

## Using the Touchscreen

Use the printer's touchscreen to configure settings, check status, and print labels, among other functions. Touch the screen with your finger to make a selection.

**Note:** Do not use a writing pen or other sharp object. Doing so may mar the touchscreen surface. If you choose to use a stylus (part number STYLUS-CAP) be sure to use only the soft rubber end.

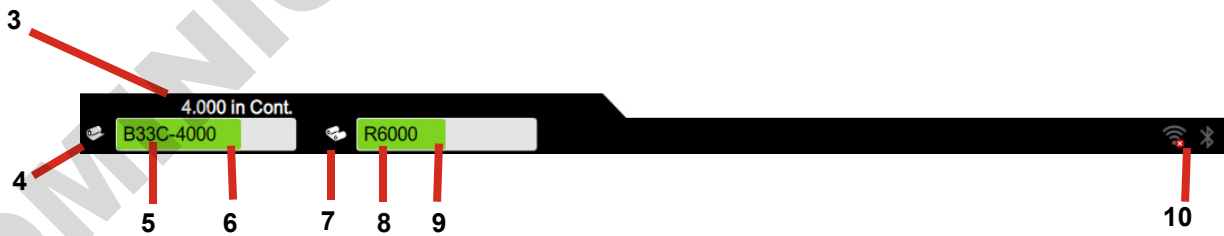
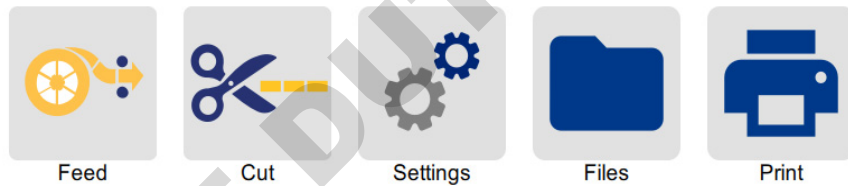

|   |                    |    |                            |
|---|--------------------|----|----------------------------|
| 1 | Home               | 6  | Supply remaining           |
| 2 | Print job status   | 7  | Ribbon status              |
| 3 | Supply size        | 8  | Ribbon part number         |
| 4 | Supply status      | 9  | Ribbon remaining           |
| 5 | Supply part number | 10 | Wi-Fi and Bluetooth status |

## Navigation and Status Bar



Tap the home button at any time to return to the home screen.



While navigating the menus, tap the back button to go back to the previous screen.

The printer and material status icons in the status bar at the bottom of the home screen provide the following information.

| Icon         | Meaning  |
|--------------|--|
|              | The text beside this icon indicates the label material installed in the printer.   |
|              | The printer cannot read the memory cell on the label supply. Label supply may not be installed, may be installed incorrectly, or the memory cell may be corrupted. |
| <br>blinking | The printer is receiving data from a computer connected with a USB cable or from the network.  |

## Material Details

To see detailed information about the installed supplies, click the label or ribbon part number in the status bar to open the *Material Details* screen.

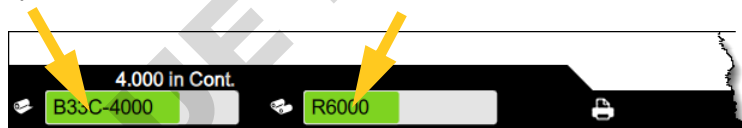

To close the *Material Details* screen, click the x in the upper right corner.

## Creating Labels

Create label files using Brady Workstation software. When you first create a label file, you specify the printer. This allows the software to provide features specific to your printer. Also, the software automatically detects the ribbon and labels installed in the printer.

For help using the software, refer to the documentation within the software.

## Storing Files on the Printer

Using Brady Workstation software, you can either send files to be printed immediately, or you can store them on the printer so they can be printed when needed even if the operator does not have access to Brady Workstation software.

To print immediately from Brady Workstation see *“Printing from Software” on page 27.*

### To store files on the printer:

1. Make sure the *Storage Location* setting on the printer is set as desired. If set to *External Storage*, make sure there is a USB drive on the printer. (See *“Storage Location” on page 18.*)
2. In Brady Workstation software, open the file and go to the **Print** screen. The software provides options to either print the file or to store it on the printer. For specifics, see the help in Brady Workstation software.
3. Choose the option to store the file on the printer.
4. Click the store button and provide a name for the file when prompted.
5. When finished, the file is saved in the specified location on the printer, either internally or on a USB drive on the printer. To print the file see *“Printing from the Printer” on page 28.*

### To delete a file:

1. On the home screen on the printer, tap **Files**.
2. Find the file that you want to delete. See *“Using the File List” on page 31.*
3. Tap the file to select it and then tap .
4. Tap .

## Printing Labels

You must have labeling software installed on your computer to create, edit or print labels. Refer to your labeling software documentation for instructions about installing and using the software. See *“Compatible Software” on page 2* for more details.

As you print labels, keep the following in mind:

- The printer cuts between labels or at the end of the job, according to the selected cut settings. See *“Adjusting Print Settings” on page 34* and *“Cutting Options” on page 35.*
- If there is no label supply or ribbon installed, printing does not start and you will be prompted to install the supplies.
- If you open the ribbon door during the print operation, printing is paused and a message prompts you to close the ribbon door. Tap the play button on the print screen to resume printing.

### Printing from Software

The simplest printing scenario is to initiate printing in Brady Workstation software and all the labels in the file print immediately.

**To print:**



1. Make sure *Print on Demand* is turned off in the printer settings. See “*Print on Demand*” on page 18.
2. Open the file in Brady Workstation and initiate printing. All labels in the file print without input from an operator. For help using the touchscreen during printing see “*Using the Print Screen*” on page 30.

**Note:** You can also send files from Brady Workstation software to a USB drive or internal storage on the printer. See “*Storing Files on the Printer*” on page 27.

## Printing from the Printer

This method is most efficient for files that get printed frequently. You must have print files stored on the printer, or on a USB drive. To store files for printing see “*Storing Files on the Printer*” on page 27.

**To initiate printing from the printer:**

1. From the home screen, tap the **Print** button. 
2. Tap the file or files that you want to print. Each file is added to the print queue in the order you select them. For more on using the file list including searching and sorting, see “*Using the File List*” on page 31.
3. Tap the print button in the upper right. 

For more details see “*Using the Print Screen*” on page 30.

## Feeding and Cutting Labels

If you install label supply that has a roughly cut front edge, it is best to feed and cut the label. Also, feed and cut if you have a partially printed job that you need to remove from within the printer.

**To feed and cut the label supply:**

1. Tap **Feed** on the touchscreen to advance the label supply. You may need to tap several times until the length of supply you want exits the printer.

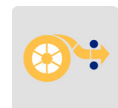

**Note:** For die-cut labels, the supply advances to the cut position which is the next die-cut label. For continuous labels, the supply advances two inches each time you tap *Feed*.

2. If desired, tap **Cut** on the touchscreen. The printer cuts off the label.



## Printing Double-Sided Sleeves

The BradyPrinter™ i5300 printer can print both sides of double-sided sleeves without wasting any leading sleeves. When printing double-sided sleeves, print side one directly from the roll. To print side two, cut the label supply at the end of the job, then load the printed strip of sleeves into the back of the printer for the second print pass.

Use Brady double-sided sleeves with part numbers beginning with B33D.

**To print double-sided sleeves:**

1. Initiate printing. See “*Printing from Software*” on page 27 or “*Printing from the Printer*” on page 28.
2. When side one is done, the printer displays a message. Tap **Cut** on the message to cut the printed sleeves.
3. Open the ribbon door and rear cover.
4. Push the leading edge of the unprinted supply backward out of the guides and back onto the roll, but do not remove the roll itself. This clears the print path.

**Note:** The roll must remain in the supply slot or the printer will indicate a tape out condition.

5. Thread the strip of sleeves through the supply guides and pull forward so the leading edge sits just past the black rubber roller. If the strip of sleeves is long, you can thread the trailing end out the slot in the back of the printer.
  - The leading edge must be the first sleeve in your print sequence.
  - The printed side must be facing down.

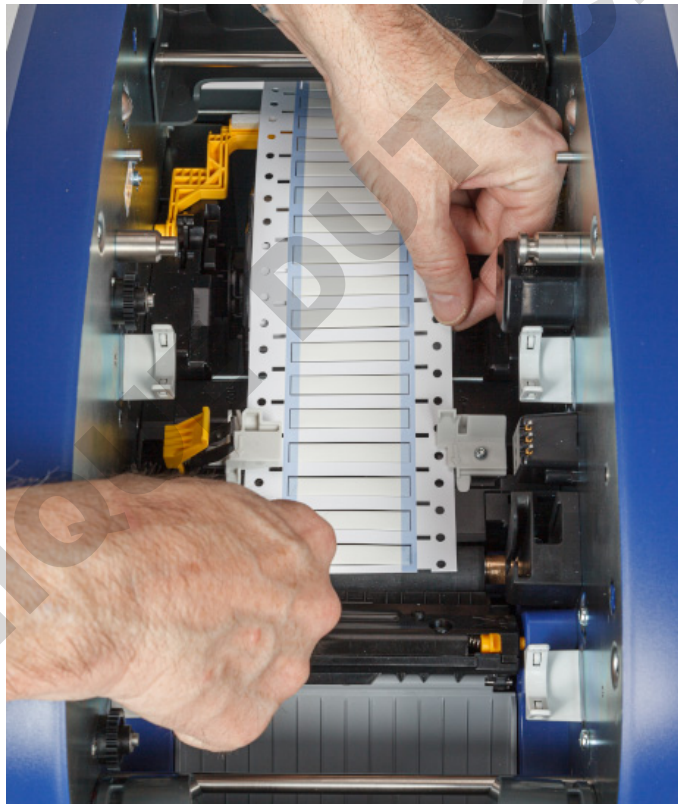

6. Close the ribbon door and the rear cover.
7. On the message on the touchscreen, tap **Print Side 2**.

## Using the Print Screen

The print screen is displayed while a file is printing. To start printing, see “Printing from Software” on page 27 or “Printing from the Printer” on page 28.

When printing starts, the touch screen displays an image of the label being printed, a counter, and a pause button. More options are available when printing is paused, as shown below.





Figure 3-1. Printing Paused



**CAUTION!** If the wrong label material for the file is in the printer, a message is displayed. Use caution when overriding this warning message. The label size loaded in the printer may not be appropriate for the print file and will generate scrap.

The following table describes the controls and information on the touch screen when a print job is running or paused.

| Button | Description  |
|--------|--|
|        | Goes to the next label. (Not available if the print file contains only one label.)             |
|        | Goes to the previous label. (Not available if the print file contains only one label.)         |
|        | Goes to the last label in the file. (Not available if the print file contains only one label.) |



| Button  | Description   |
|---|---|
|  | Goes to the first label in the file. (Not available if the print file contains only one label.)   |
|  | Print. Start or resume printing.  |
|  | Pause printing.   |
| label number  | Displays the current position in the label file as well as the total number of labels. Tap the current label number (within a rectangle) to jump to a particular label. A keypad opens. Tap the label number on the keypad and then tap the enter button. |
|  | Cancel. Only available when printing is paused.   |
|  | Menu. Provides a control to turn on the print on demand feature for the current print job only. For a description of the feature see <i>"Print on Demand" on page 18.</i>   |

## Using the File List

Use the file list to select files to print, and to see information about files.

### To use the file list:



1. Open the file list.
  - Tap **Files** on the home screen. The list is always available this way.
  - Tap **Print** on the home screen. The list is only available if printing is not in progress, otherwise the print screen displays.
2. Make sure the correct file location is selected. Tap the down arrow next to the file location and then tap the desired location.
  - **Internal Memory** shows files residing on the printer.
  - **External Storage** shows files residing on a USB drive that is plugged in to the printer.
3. Change the file view if desired. Tap the menu button  and then tap one of the following.
  - **Thumbnail View** displays the files in a grid showing thumbnail images.
  - **List View** displays the files as a list of file names.
4. Find the files that you want to work with. Drag your finger up or down on the screen to scroll through the list of files. For help refining the list see *"Searching, Sorting, and Filtering" on page 32.*
5. Tap files to select them. You can tap multiple files. Once selected you can view file information or print.

-  Only visible when a single file is selected. Tap to display file information which consists of the following. You can also delete or print the file from the information screen.
  - An image of the first label in the file.
  - The label supply the file was created for.
  - The size of the label.
  - The number of labels in the file.
  - The date the file was created.
  - The size of the file in bytes.
-  Tap to add all selected files to the print queue and begin printing.



## Searching, Sorting, and Filtering

If the list of files is long, you can find the file that you want faster by searching, sorting, or filtering the list. To display the list of files see *“Using the File List” on page 31*.

### To search for a label in the list:

1. With the list of files open, tap the menu button .
2. Tap **Search**.
3. Use the keyboard displayed on the touchscreen to type all or part of a file name to search for. The search is not case sensitive.
4. Tap the enter button. 
5. The list of files displays only files found in the search. To clear the search and display all files again, tap the X next to the search term above the list.

### To sort the list:

1. With the list of files open, tap the menu button .
2. Tap **Sort**.
3. Tap one of the following options.
  - **Name** sorts alphabetically by file name. Tap *Name* again to switch the sort direction between a-z or z-a.
  - **Last modified** sorts by date. Tap Last modified again to switch the sort direction from newest to oldest or vice versa.
  - **Number of labels** sorts by the number of labels in the file. Tap *Number of labels* again to switch the sort direction from most to least or vice versa.
4. Tap  when done.

### To filter the list by file type:

1. Tap **Files** on the home screen. Filtering is not available from *Print* because only documents (label files) are printed.

2. Tap the menu button .
3. Tap **Filter** and then tap **Documents**, **Images**, or **Fonts**. Documents are label files. Graphics and fonts are used in scripts.

## Using the Print Queue



The print queue is available from the print screen when files are being printed. Use it to add more files to the queue, delete files from the queue, or change the print order.

### To see the print queue:

1. Start printing a file or files. See *“Printing Labels”* on page 27.
2. Tap the **QUEUE** tab to see the queue.



## Adding Files to the Queue

### To add files to the queue during printing:



1. While printing, tap the **QUEUE** tab on the print screen.
2. Tap  to open the file list.
3. Find the file that you want to add. See *“Using the File List”* on page 31.
4. Tap the file and then tap .

## Removing Files From the Queue

### To remove one file from the queue:



1. While printing, tap the **QUEUE** tab on the print screen.
2. Tap the pause button  to pause printing, and then tap **Pause Now**.
3. Tap the file that you want to remove from the queue.
4. Tap , and then tap **Cancel Job**.

### To remove all files from the queue:

1. While printing, tap the **QUEUE** tab on the print screen.
2. Tap the pause button  to pause printing, and then tap **Pause Now**.
3. Tap .
4. Tap **Cancel All**, and then tap **Cancel Job**.

## Change the Print Order

### To change the print order:

1. While printing, tap the **QUEUE** tab on the print screen.
2. Tap the file that you want to move up or down in the queue. You cannot move the first file in the list.
3. Tap  or  to move the file.

## Adjusting Print Settings

These settings will be used on all print jobs. If you want to change them in a single job, be sure to either change them back or reset to the factory default settings when you are done.

### To change print settings:

1. On the home screen tap **Settings**. 
2. Tap **Print Adjustments**.
3. Tap the desired print adjustment. See the following sections for details on each.

**Note:** The *Reset Default* button sets the printer back to factory defaults.

## Print Speed

Print speed lets you adjust the speed setting from 1 to 10 inches per second (ips) on the 300 dpi printer model and 1-5 ips on the 600 dpi model. Optimal print speed settings are set automatically by the smart cell for the installed supply and should only be changed if you are experiencing problems. For example, you can change print speed if you want to print graphics or other densely populated labels more slowly to ensure complete coverage.

Use the slider to increase or decrease the speed.

**Note:** The selected print speed setting will stay in effect for all subsequent print jobs with the currently installed label supply. When new supply is installed, the print speed is reset to the default setting. The print speed level is also reset by rebooting the system.

## Print Energy

Use the slider to adjust for darker or lighter printing. Print a label to test the setting.

The print energy setting defines how much heat is applied to the printhead when printing a label. The darker the print energy, the more ink is transferred to the label. Optimal print energy settings are set automatically by the smart cell for the installed label supply and should only be changed if you are experiencing problems. For example, if printing is spotty you may want to increase the print energy to

make sure more of the ribbon ink transfers to the label. However, if your ribbon is sticking or tearing during printing, the heat energy may be too high and should be reduced.



**CAUTION!** Constantly printing at high energy levels may cause printer jams or other printing errors and may reduce the overall life of your printhead.

**Note:** The selected print energy setting will stay in effect for all subsequent print jobs with the currently installed label supply. When new label supply is installed, the print energy level is reset to the default setting. The print energy level is also reset by rebooting the system.

### Print Position

Tap the arrows to move the print in the label image left, right, up, or down.

The measurements shown in the upper right indicate how much the beginning print position will shift relative to the factory setting; it does *not* represent the distance from the left edge of the label. Units are in inches or millimeters depending on what units are set in *Settings > System Configuration > Measurement Units*.

To reset to the factory setting (0, 0), tap .

### Cutting Options

Specify whether the printer should cut between each label, at the end of the job, or never. Cutting options set in Brady Workstation or a BPL script override this setting.

### BPL Scripts

#### Print Orientation

Use to rotate the print for BPL script jobs.

#### Sample Not Rotated

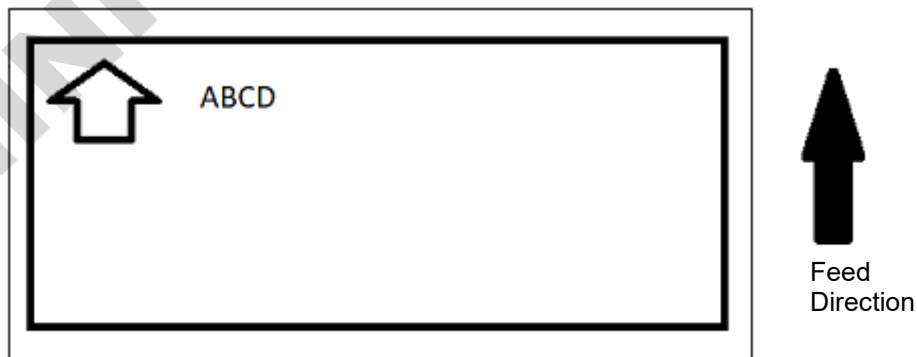

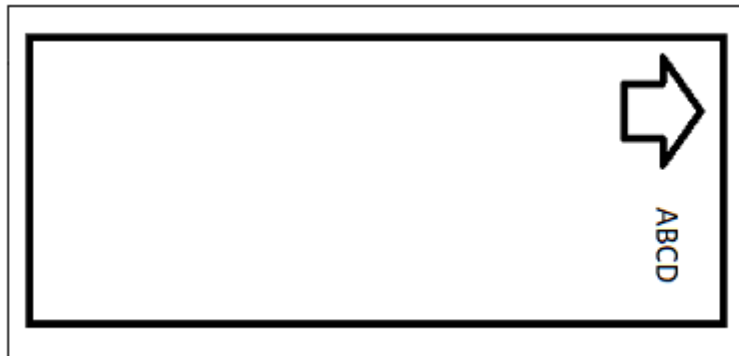
**Sample Rotated****Mirror Print**

Print labels suitable for reading in a mirror or through the back of the label. For example, use this if printing on a clear label supply that will be applied to glass so that the label will be readable from the other side of the glass.

**Print on Demand**

See “Print on Demand” on page 18.

## External Hardware

Follow these steps if you want to connect a keyboard to a USB port.

**To connect an external keyboard:**

1. Plug the keyboard’s USB cable into the USB port on the printer.
2. On the home screen tap **Settings**. 
3. Select **External Hardware**.
4. Select **USB Keyboard** then choose the appropriate type of keyboard from the list.

## 4 Using Scripts

---

The BradyPrinter™ i5300 printer supports the following scripting languages.

- BPL (Brady Programming Language)
- ZPL
- jScript
- DPL

Programming is beyond the scope of this manual. Refer to the programming manual for the scripting language that you choose to use.

- For BPL, see the *Brady Printer Language Programmer's Manual*.
- For ZPL, jScript, and DPL refer to the vendor's documentation. A list of commands that the printer supports in these languages can be found in the *BradyPrinter i3300 and i5300 Supported Scripting Languages* manual.

These manuals can be found on [www.BradyID.com/i5300](http://www.BradyID.com/i5300).

**Minimum Font Sizes:** The BradyPrinter™ i5300 printer supports the following minimum font sizes in scripts. If using DPL, be aware that font sizes are not set explicitly, but rather with the bounding width and height.

- 5 pt minimum font size for 300 dpi printers
- 4 pt minimum font size for 600 dpi printers

## Graphics & Fonts

If your script files use graphics or text that aren't already on the printer, you will need to import them before running the script.

### Import

To import graphics and fonts from a computer to the printer, first transfer the files to a USB flash drive. Then follow these steps:

1. Connect the USB flash drive to any available USB port on the printer.
2. On the home screen, tap **Files**.
3. If the screen says *INTERNAL MEMORY* in the upper left, tap **INTERNAL MEMORY** and then tap **External Storage**.
4. Tap the menu button .
5. Tap **Filter** and then tap **Images** or **Fonts**.



6. In the list of files, tap on each file that you want to import.
7. Tap . The files begin importing.

A progress bar will display while the import is taking place.

**Note:** The printer displays a low memory message if it runs out of space.

## Delete

To delete graphics and fonts imported to the printer, follow these steps:



1. On the home screen tap **Files**.
2. If the screen says *EXTERNAL STORAGE* in the upper left, tap **EXTERNAL STORAGE** and then tap **Internal Memory**.
3. Tap the menu button .
4. Tap **Filter** and then tap **Images** or **Fonts**.
5. In the list of files, tap on each file that you want to delete.
6. Tap , and then tap **Delete**.

## Running a Script

Before running a script on the BradyPrinter™ i5300 printer:

- Create the script on a computer and copy it to a USB drive. See “Using Scripts” on page 37.
- Make sure any needed fonts and graphics are on the printer. See “Graphics & Fonts” on page 37.

**To run a script:**

1. Insert the USB drive containing the script into a USB port on the printer.
2. On the home screen, tap **Files**. 
3. If the screen says *INTERNAL MEMORY* in the upper left, tap **INTERNAL MEMORY** and then tap **External Storage**.
4. Tap the script you want to run and then tap .

## 5 Maintenance

### Displaying System Information

The *About* screen displays version numbers for various components of the system. Check the *Firmware driver* version when considering a firmware upgrade.

**To view system information:**

1. From the home screen, tap **Settings**. 
2. Tap **About**. Additional information available by tapping *Details* is primarily for use when instructed by Brady Support.

### Installing Firmware Upgrades

Upgrades to firmware (printer system software) are available online. For information on how to locate the current firmware version on your printer, see “*Displaying System Information*” above.



**CAUTION!** Do not interrupt printer power during an upgrade.

**To upgrade firmware:**

1. On a computer, go to the technical support website for your region. See “*Technical Support and Registration*” on page iv.
2. Find firmware updates.
3. Find the most recent BradyPrinter™ i5300 firmware upgrade.
4. Download the firmware.
5. Save the downloaded file to a USB drive.
6. Connect the USB drive to the USB port on the printer. The printer recognizes the upgrade file and displays a message on the touch screen.
7. Follow the instructions on the touchscreen. When the upgrade is complete, the printer restarts.



## Updating Y and B Values

Y and B values are included in a database of label and ribbon part information that enables the printer to work optimally with various supplies.

Update Y and B values periodically to make sure the printer has data for any new label supplies. Also, update if you have ordered a custom label supply from Brady and it came with new Y and B values.

You do not need to know your current database version. The printer displays a confirmation message showing the version numbers during the import process.

### To update Y and B values:

1. On a computer, go to the technical support website for your region. See *“Technical Support and Registration”* on page iv.
2. Find firmware updates and the most recent BradyPrinter™ i5300 database (Y and B) update.
3. Download the database update.
4. Save the downloaded file to a USB flash drive.
5. Connect the USB flash drive to a USB host port on the printer.
6. On the home screen, tap **Files**. 
7. Tap the menu button in the upper right. 
8. Tap **Import Y & B Files**. Follow the instructions on the screen to complete the import. The new values take effect as soon as the import completes.

## Cleaning the Printer

### Cleaning Dust and Debris from Printer

Whenever performing any maintenance on the printer, you should also clean dust and label debris from within the printer.

#### Materials Required:

- Compressed Air Bottle, purchased locally (e.g., HOSA AIR-464 Gear Duster)
- Safety Glasses



**CAUTION!** Always wear safety glasses when using compressed air.

- Lint-free Cloth
- Isopropyl Alcohol

- Pre-moistened cleaning swabs (PCK-6). We recommend using these swabs because they are lint free and the isopropyl alcohol contains no additives. You can use your own swabs and isopropyl alcohol.

**To clean debris from within the printer:**

1. Remove power and supplies from the printer (see *“Power” on page 6* and *“Install or Change Supplies” on page 11*).
2. With safety glasses on, spray compressed air on all visible areas inside the printer to remove accumulated dust and debris.
3. Use a cloth moistened with isopropyl alcohol to wipe any remaining dust and debris from inside the printer.
4. Use pre-moistened cleaning swabs to clean areas that you could not reach with a cloth.
5. Replace the ribbon and labels.
6. Close all covers and plug in the power cord.

## Cleaning the Printhead



CAUTION! If the printhead is hot, allow it time to cool before proceeding. Handling a hot printhead could result in burns.

**Materials Required**

- Pre-moistened cleaning swabs (PCK-6).



CAUTION! Use only the alcohol swabs from part number PCK-6. Using other materials may permanently damage the printhead.

**To clean the printhead:**

1. Remove power and supplies from the printer (see *“Power” on page 6* and *“Install or Change Supplies” on page 11*).

2. Gently rub a new pre-moistened foam swab across the green and black area of the printhead. Use as many swabs as necessary to thoroughly clean the surface.

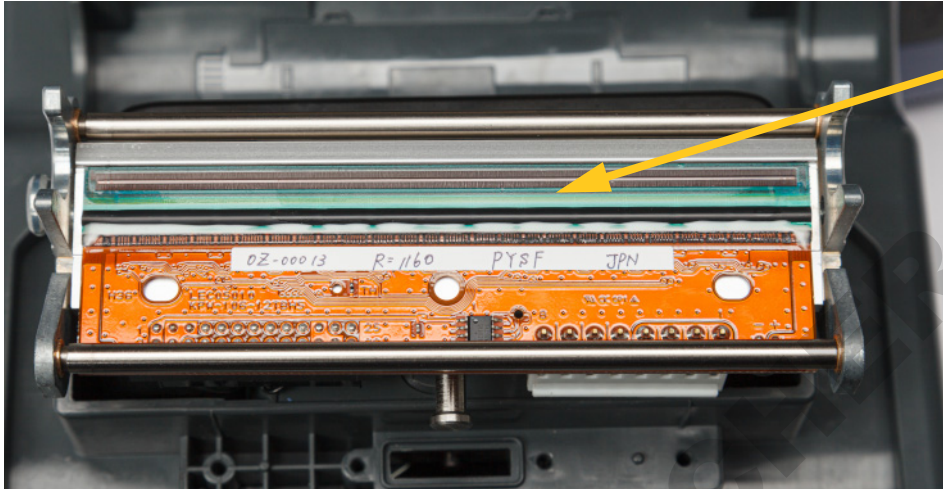

Clean here.



**CAUTION!** Do not rub the swab over the bronze-colored area of the printhead. This may short the circuit.

3. Replace the ribbon and label cartridges.
4. Dispose of the swabs.
5. Close all covers and plug in the power cord.

## Cleaning the Print Roller

Clean the print roller frequently, especially if you see ink or adhesive buildup on the roller. If there is visible damage to the roller or small beads of rubber on the roller, then replace the roller. See *“Replacing the Print Roller” on page 54.*

### Materials Required for Cleaning the Roller

- Pre-moistened cleaning swabs (PCK-6).

### To clean the print roller:

1. Remove power and supplies from the printer (see *“Power” on page 6* and *“Install or Change Supplies” on page 11*).

2. Open a new pre-moistened foam swab and use it to clean the rubber roller. Use as many swabs as necessary to thoroughly clean the surface.

Turn the roller to access the entire surface. Push the top of the roller firmly toward the back of the printer, which will offer some resistance.



3. Replace the ribbon and label cartridge after the alcohol evaporates.
4. Dispose of the swabs.
5. Close all covers and plug in the power cord.

## Cleaning the Sensors

The supply and cutter sensors are located inside the printer and may be covered with dust that results from cutting the labels. One of the supply sensors is located under the yellow supply guide. The cutter sensor is located above the cutting blade and is visible only when the cutter is released.

### Materials Required

- Pre-moistened cleaning swabs (PCK-6). We recommend using these swabs because they are lint free and the isopropyl alcohol contains no additives. You can use your own swabs and isopropyl alcohol.

### To clean the sensors:

1. Remove power and supplies from the printer (see *“Power”* on page 6 and *“Install or Change Supplies”* on page 11).

2. Squeeze the two yellow cutter tabs to release the cutter. The cutter mechanism falls forward to expose the cutter sensor, and the exit chute drops down a little to accommodate the motion.

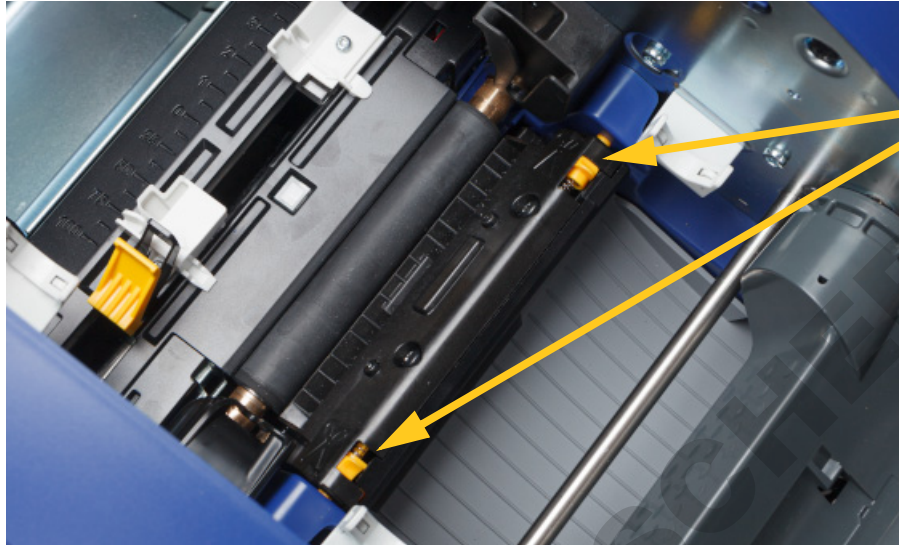

**cutter tabs**

3. With a clean pre-moistened foam swab, gently wipe the surface of each sensor.
  - Cutter sensor
  - Center die-cut sensor
  - Side label sensors (label out and die-cuts)

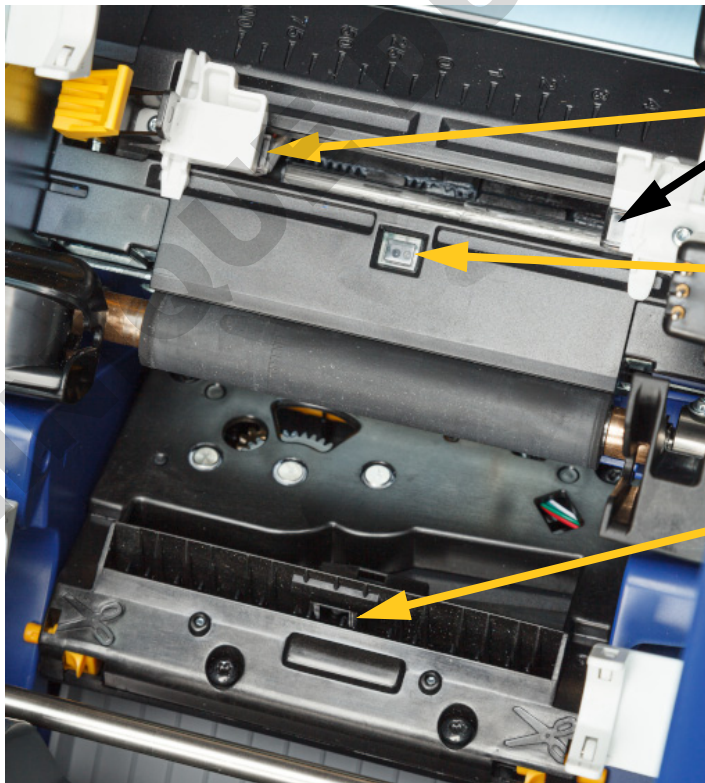

**side label sensors**

**center die-cut sensor**

**cutter sensor**

4. Lift the enclosed side of the cutter housing until it snaps into its original position as shown below.

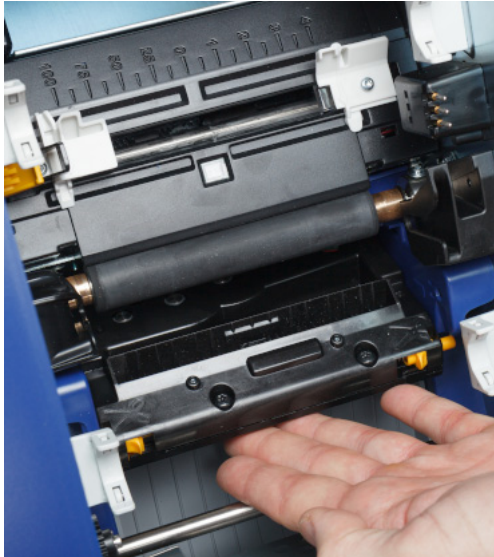

5. Replace the ribbon and label cartridges.
6. Dispose of the swabs.
7. Close all covers and plug in the power cord.

## Cleaning the Cutter Blade

**Note:** When cleaning the cutter, you should also clean the supply and cutter sensors as discussed in “Cleaning the Sensors” on page 43.

### Materials Required

- Pre-moistened cleaning swabs (PCK-6). We recommend using these swabs because they are lint free and the isopropyl alcohol contains no additives. You can use your own foam swabs and isopropyl alcohol.
- Cutter Cleaning Tool (B31-CCT)

### To clean the cutter blade:

1. Remove power and supplies from the printer (see “Power” on page 6 and “Install or Change Supplies” on page 11).

2. Squeeze the two yellow cutter tabs to release the cutter. The cutter mechanism falls forward to expose the blade, and the exit chute drops down a little to accommodate the motion.

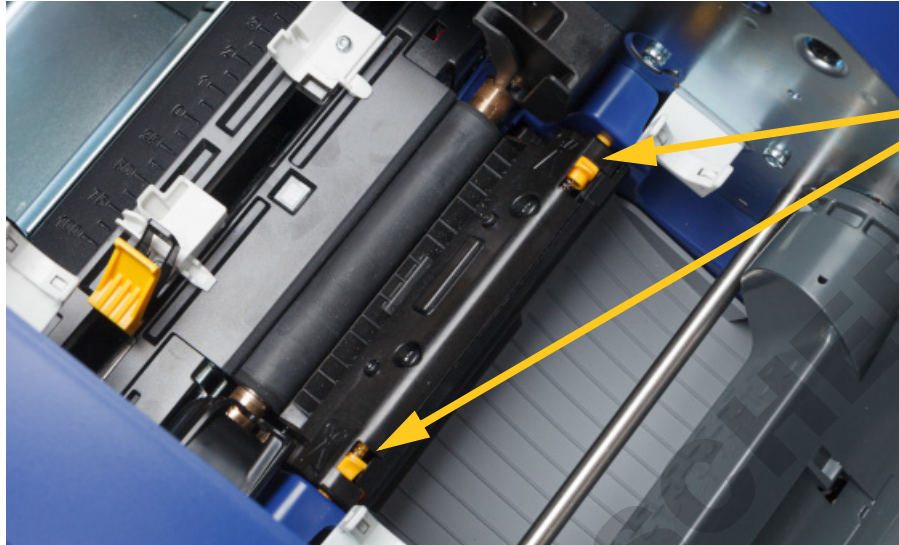

**cutter tabs**

3. Clean the metal cutting blade.
  - a. If the cutting blade shows significant residue, use the cutter cleaning tool in the cleaning kit to gently scrape the residue off the cutting blade.
  - b. Open a pre-moistened cleaning swab. Alternatively, moisten a foam swab with isopropyl alcohol. Do not allow the alcohol to drip from the swab.
  - c. Clean cutting blade with moistened swab until all residue is removed.
  - d. Clean beneath the edges of the blade housing with moistened swab. To avoid forcing residue deeper into the machine, use motions from the outer edge of the blade toward the center.
  - e. Continue cleaning until no residue is visible and clean swabs do not become discolored.

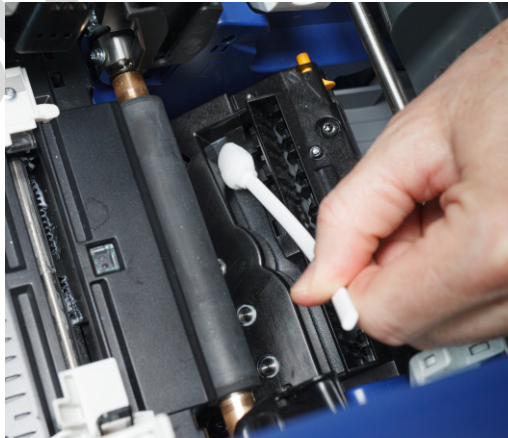

4. Lift the enclosed side of the cutter housing until it snaps into its original position as shown below.

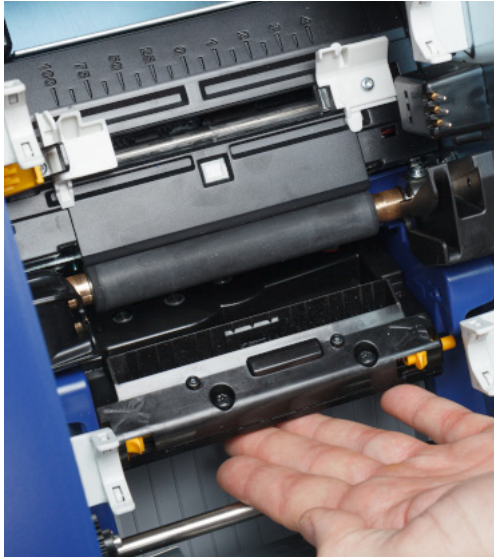

5. Replace the ribbon and label cartridges.
6. Dispose of the swabs.
7. Close all covers and plug in the power cord.

## Cleaning the Cutter Blade Exit Area

This procedure cleans the cutter blade exit area and the exit chute.

**Note:** Clean the exit area after cleaning the cutter blade and sensors.

### Materials Required

- Pre-moistened cleaning swabs (PCK-6). We recommend using these swabs because they are lint free and the isopropyl alcohol contains no additives. You can use your own swabs and isopropyl alcohol.

### To clean the exit area and chute:

1. Remove power and supplies from the printer (see *“Power”* on page 6 and *“Install or Change Supplies”* on page 11).
2. Close the ribbon door. It does not need to snap into place.

3. With a pre-moistened foam swab, clean the exit chute entrance and exit chute ramp.



4. Replace the ribbon and label cartridges.
5. Close all covers and plug in the power cord.

## Cleaning the Display

### Materials Required

- Lint-free cloth, non-abrasive
- Isopropyl alcohol or a pre-moistened cloth (appropriate for cleaning LCD displays)



**CAUTION!** Normal cleaners with ammonia, soaps, or any acids can damage the screen. Use only a lint-free cloth dampened with isopropyl alcohol.

### To clean the touchscreen:

1. Lightly moisten a lint-free cloth with isopropyl alcohol, or use a pre-moistened cloth suitable for cleaning a computer screen.
2. Gently rub the damp cloth across the screen until all of the residue is removed.

## Clearing Jams

### Printer Jam

#### To clear jams from the printer:

1. Remove all damaged ribbon and/or labels from the printer.
2. Check that there is no damage to the printhead, cutter blades, sensors, etc.
3. Check whether any cleaning is needed. If cleaning is required, see *“Cleaning the Printer”* on page 40 for details.

4. Reload ribbon and labels and clear all error messages.

## Cutter Jam

To clear a jam from the cutter:

1. Cut the supply as shown below.



2. Squeeze the tabs to release and tilt the cutter module forward and down.

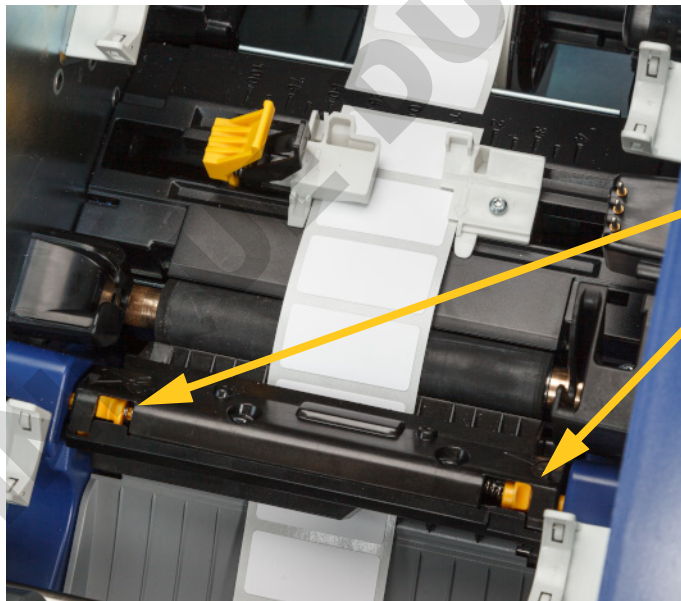

3. Rotate the cutter gear counter-clockwise to lower the blade.



4. Remove the supply.
5. Rotate the gear clock-wise until the blade is no longer visible.
6. Lift the enclosed side of the cutter housing until it snaps into its original position as shown below.

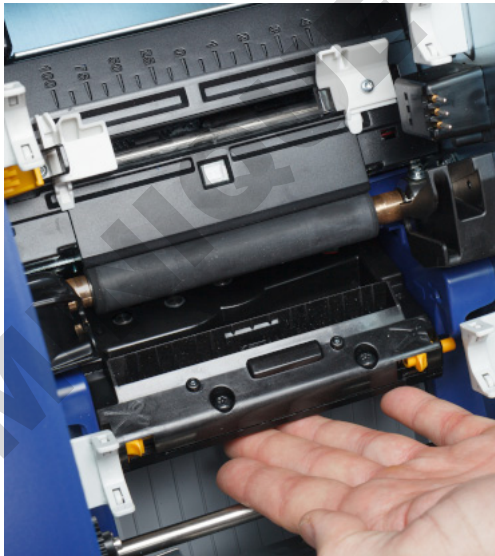

## Replacing the Supply Wiper

Replace the supply wiper pad when it has become soiled or the print quality is poor.

### Materials Required

- Replacement wiper pad (part number B31-WIPER)

### To replace the foam wiper in the wiper arm:

1. Remove power and supplies from the printer (see *“Power”* on page 6 and *“Install or Change Supplies”* on page 11).
2. Lift and hold the wiper arm while grasping the tab of the wiper pad.

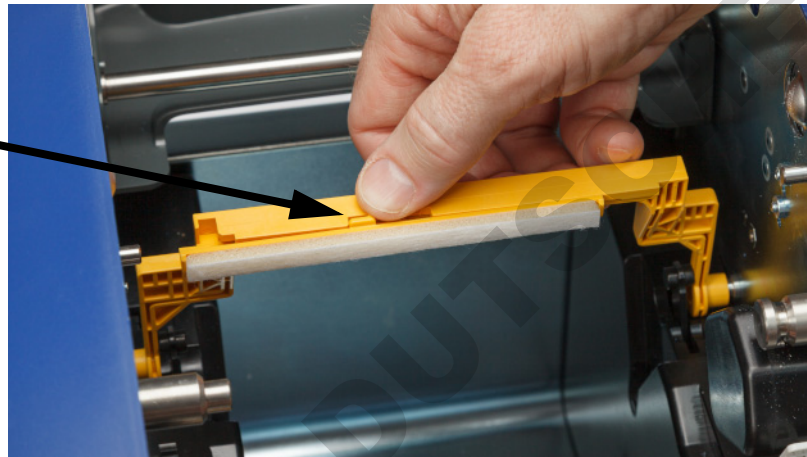

3. Slide the wiper pad to the left until it pops out of the wiper arm.



- To replace the wiper pad, insert the ridge on the new wiper pad into the slot in the wiper arm so that the tab is toward the left side of the cutout in the wiper arm, as shown below. Slide the new pad to the right until it snaps into place.

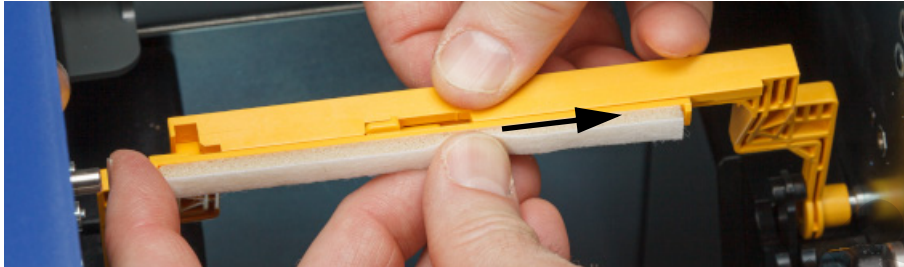

- Replace the ribbon and label supply.
- Close all covers and plug in the power cord.

## Replacing the Printhead

Replace the printhead if you consistently see the same unprinted spots on labels. Both 300 and 600 dpi printheads are available. Make sure to use the appropriate printhead for your model of printer. You can see whether you have a 300 or 600 dpi model on the about screen (see *“Displaying System Information”* on page 39). A mismatched printhead will not work properly.

Contact Brady Technical Support for the replacement printhead part number. See *“Technical Support and Registration”* on page iv.



**CAUTION!** Take the following precautions to avoid damaging the printhead with electrical discharge or mechanical influences.

- Set the printer on a grounded surface. Leave the printer plugged in, but turn off the power. (See *“Power”* on page 6.)
- Ground yourself (with an anti-static wrist strap, for example).
- Do not touch the connectors.
- Do not touch the heating element with hands or hard objects. (The heating element is the dark brown strip called out in the image below.)

### To replace the printhead:

- Remove the label supply from the printer. See *“Label Supplies”* on page 13.
- Open the ribbon door and remove the ribbon. See *“Ribbon”* on page 11.



**CAUTION!** If the printhead is hot, allow it time to cool before proceeding. Handling a hot printhead could result in burns.

3. Pull on the locking pin and lift up the printhead.

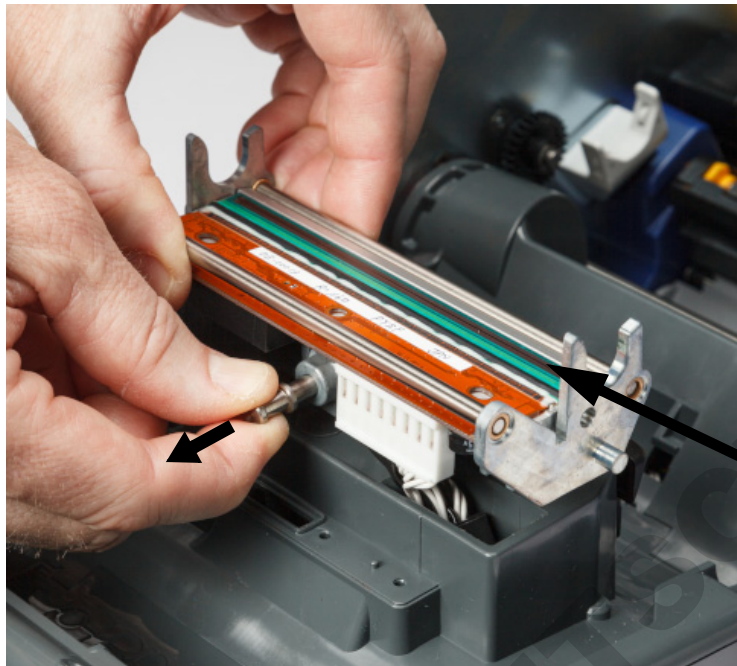

heating element

4. Rotate the printhead to expose the cables. Note the orientation of the cables so that you attach them to the new printhead in the same orientation.

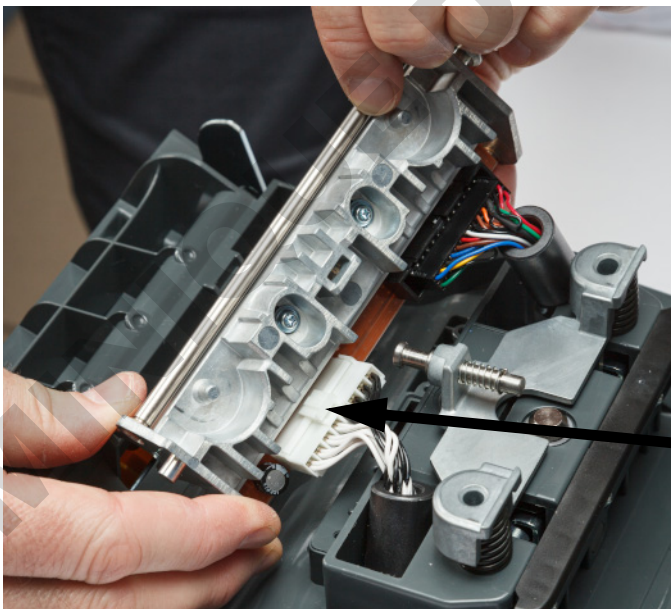

Squeeze tab to release.

5. Remove the two cable connectors, one white and one black. To remove the white cable, squeeze the tab to release it while pulling it out.
6. Insert the cable connectors into the new printhead.

7. While pulling the pin out, set the new printhead on its mounting.

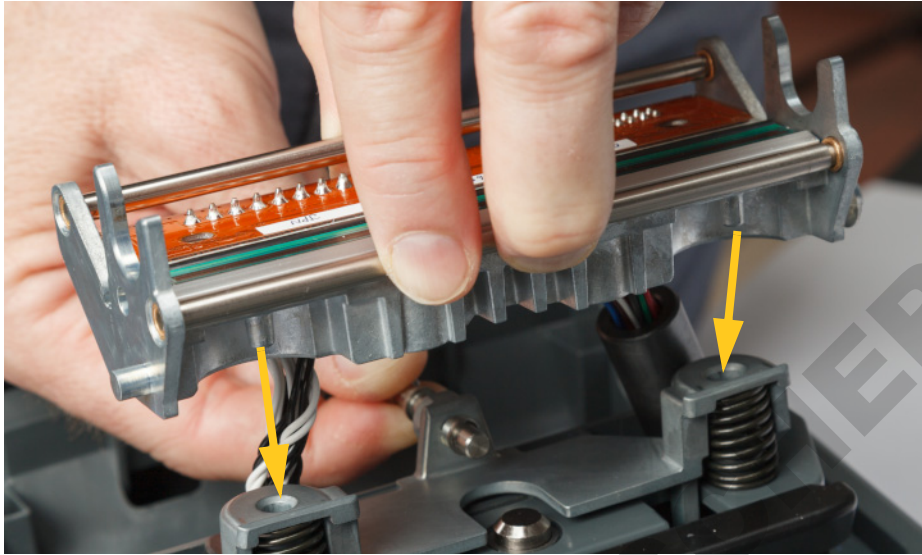

8. Release the pin to lock the printhead in place.
9. Reinstall the label supply and ribbon, then close the ribbon door and rear cover. See *“Install or Change Supplies”* on page 11.

## Replacing the Print Roller

The black rubber print roller is a wearable part and must be cleaned frequently and replaced immediately if worn. When the print roller is worn you may notice poor print quality, the roller may begin to have a flattened appearance in places, or you may notice other visible signs of damage.



**CAUTION!** Using a worn print roller can damage the printhead.

### Materials required:

- Torx screwdriver size T10
- Print roller (Contact Brady Technical Support for the replacement part number. See *“Technical Support and Registration”* on page iv.)

### To replace the print roller:

1. Remove power and supplies from the printer (see *“Power”* on page 6 and *“Install or Change Supplies”* on page 11).

- Using a T10 torx screwdriver, loosen the screw that secures the coupling holding the roller in place. You may need to manually rotate the print roller to align the screw with the opening for access.

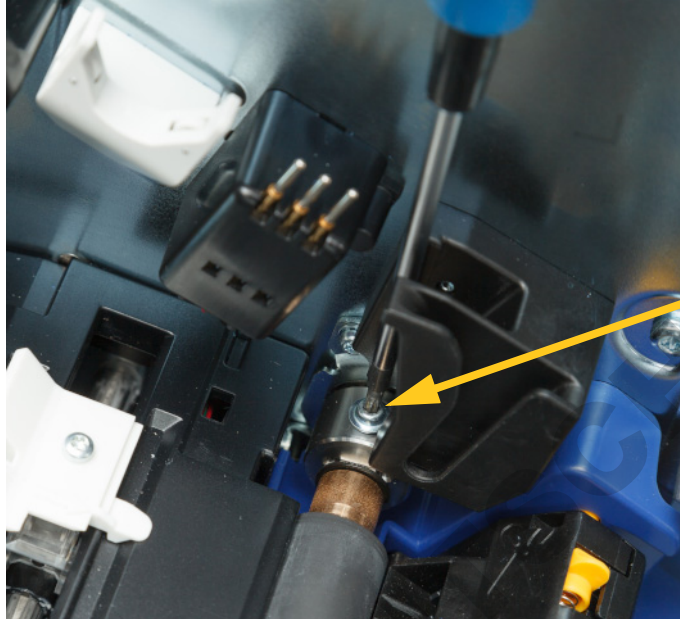

- Locate the roller access hatch on the left-hand side of the printer. Rotate the hatch cover clockwise to release it. Remove the hatch cover.



4. Using a T10 torx screwdriver, remove the two screws.



5. Pull the print roller out.



6. Insert the new print roller into the printer.
7. Insert the shaft into the coupling so that the flat side on the end of the shaft aligns with the flat part of the coupling.

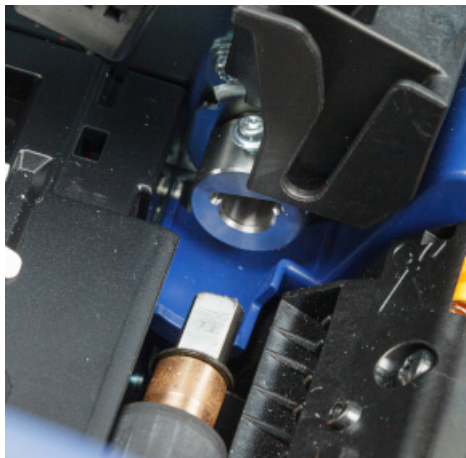

8. Tighten the screw on the coupling to secure the roller in place.

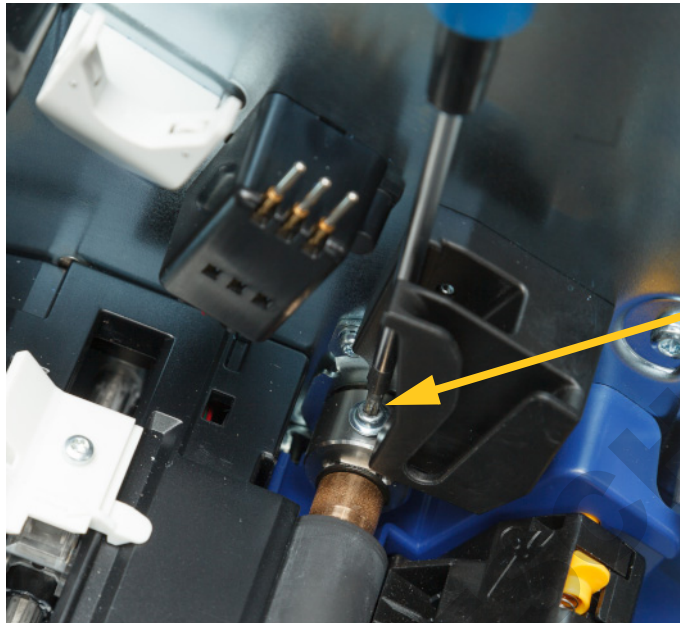

9. Reinstall the two screws on the yellow disk in the access hatch. Take care not to overtighten the screws.



10. Replace the cover on the hatch and turn counter-clockwise to lock it in place.

## 6 Troubleshooting

Use the following table to troubleshoot problems. In situations where the printer displays an error message, follow the instructions on the touchscreen.

| Problem                                   | Cause  | Corrective Action  |
|---|--|--|
| Printer does not power up when turned on. | Power cord has been pulled out of printer or wall socket.  | Check power cord.  |
| Screen freezes                            | User Interface error   | <ol style="list-style-type: none"> <li>1. Press the sleep button.</li> <li>2. After printer goes to sleep, press the sleep button again.</li> </ol>  <p>If that doesn't work:</p> <ol style="list-style-type: none"> <li>1. Turn off the power switch on the back of the printer.</li> <li>2. Wait five seconds and then turn the power switch on.</li> </ol> |
| Printer will not feed labels.             | <ul style="list-style-type: none"> <li>• The leading edge of the label roll is not inserted correctly.</li> <li>• The leading edge of the label roll is uneven or torn (not a straight edge).</li> </ul> | <ul style="list-style-type: none"> <li>• Install the labels correctly. See <i>"Label Supplies"</i> on page 13.</li> <li>• Cut a straight leading edge on the label roll.</li> </ul>  |
| Faint print on labels.                    | Ribbon not advancing correctly.  | <ul style="list-style-type: none"> <li>• Tension the ribbon by rotating the rewind spool (spool closest to printer with the ribbon door open) in a downward direction until all slack is removed.</li> <li>• Try another ribbon cartridge.</li> </ul>  |
|   | Print energy might be too low.   | Adjust the print energy setting (see <i>"Print Energy"</i> on page 34).  |
| No print on the label.                    | The label or ribbon is not loaded correctly or out of ribbon.  | <ul style="list-style-type: none"> <li>• Reinstall the ribbon cartridge.</li> <li>• Load a new ribbon.</li> </ul>  |
| Poor print quality.                       | Ribbon and labels are incompatible, or using an incorrect label supply and ribbon combination.   | <ul style="list-style-type: none"> <li>• Verify the correct ribbon for the label roll is loaded in the printer.</li> <li>• Change the ribbon or label supply.</li> </ul>   |
|   | Dust or adhesives accumulated on the printhead.  | Clean the printhead (see <i>"Cleaning the Printhead"</i> on page 41).  |
|   | Supply wiper dirty.  | Replace supply wiper (see <i>"Replacing the Supply Wiper"</i> on page 51).   |

| Problem   | Cause  | Corrective Action   |
|---|--|---|
| Void areas or lines appear on printed text.   | Ribbon wrinkling.  | <ul style="list-style-type: none"> <li>• Tension the ribbon by rotating the rewind spool (spool closest to the printer with the ribbon door open) in a downward direction until all slack is removed.</li> <li>• Try another ribbon cartridge.</li> </ul> |
| Cut quality is poor.  | Cutter needs cleaning.   | Clean the cutter (see <i>“Cleaning the Cutter Blade”</i> on page 45).   |
| Supply shifts when printing frames around label causing a slight misalignment of the frame.   | Supply guides not adjusted correctly, producing slack that allows the labels to shift during printing. | Adjust supply guides so they are snug against the labels. To make fine adjustments to the frame, see <i>“Print Position”</i> on page 35.  |
| The printer continues to display a message about the label supply even though I have performed all the corrections provided in the message. | A dirty sensor could be preventing the printer from correctly reading the label supply.                | Clean all the sensors, including the cutter sensor. See <i>“Cleaning the Sensors”</i> on page 43.   |

# A Regulatory Compliance

---

## Agency Compliance and Approvals

### United States

#### *FCC Notice*

**Note:** This equipment has been tested and found to comply with the limits for a Class A digital device, pursuant to part 15 of the FCC Rules. These limits are designed to provide reasonable protection against harmful interference when the equipment is operated in a commercial environment. This equipment generates, uses, and can radiate radio frequency energy and, if not installed and used in accordance with the instruction manual, may cause harmful interference to radio communications.

Operation of this equipment in a residential area is likely to cause harmful interference in which case the user will be required to correct the interference at his own expense.

Changes or modifications not expressly approved by the party responsible for compliance could void the user's authority to operate the equipment.

This device complies with Part 15 of the FCC Rules. Operation is subject to the following two conditions: (1) This device may not cause harmful interference and, (2) this device must accept any interference received, including interference that may cause undesired operation.

### Canada

Innovation, Science and Economic Development (ISED)

Canada ICES-003:

CAN ICES-3 (A)/NMB-3(A)

### Mexico

IFETEL notice: La operación de este equipo está sujeta a las siguientes dos condiciones: (1) es posible que este equipo o dispositivo no cause interferencia perjudicial y (2) este equipo o dispositivo debe aceptar cualquier interferencia, incluyendo la que pueda causar su operación no deseada.

## Europe



**WARNING!** This is a Class A product. In a domestic environment, this product may cause radio interference in which case the user may be required to take adequate measures.



### Waste Electrical and Electronic Equipment Directive

In accordance with the European WEEE Directive, this device needs to be recycled in accordance with local regulations.

### RoHS Directive 2011/65/EU, 2015/863/EU

This product is CE marked and complies with the European Union's Directive 2011/65/EU OF THE EUROPEAN PARLIAMENT AND OF THE COUNCIL of 8 June 2011 on the restriction of the use of certain hazardous substances in electrical and electronic equipment.

EU Directive 2015/863 of 31 March 2015 (RoHS 3) amends Annex II to Directive 2011/65/EU of the European Parliament and of the Council as regards the list of restricted substances.

### Batteries Directive 2006/66/EC



This product contains a lithium coin cell battery. The crossed-out wheeled bin shown to the left is used to indicate 'separate collection' for all batteries and accumulators in accordance with European Directive 2006/66/EC. Users of batteries must not dispose of batteries as unsorted municipal waste. This Directive determines the framework for the return and recycling of used batteries and accumulators that are to be collected separately and recycled at end of life. Please dispose of the battery according to your local regulations.

### Notice to Recyclers

#### To remove the lithium coin cell battery:

1. Disassemble printer and locate the lithium coin cell battery located on the main circuit board.
2. Using a small screwdriver, pry the battery from its holder and remove the battery from the board. Dispose of in accordance with local regulations.

## Turkey

Turkish Ministry of Environment and Forestry

(Directive on the Restriction of the use of certain hazardous substances in electrical and electronic equipment).

Türkiye Cumhuriyeti: EEE Yönetmeliğine Uygundur

## China

China RoHS Hazardous Substance Table related to this product is available at [www.BradyID.com/i5300compliance](http://www.BradyID.com/i5300compliance)

### 警告

此为 A 级产品。在生活环境中，该产品可能会造成无线电干扰。在这种情况下，可能需要用户对于干扰采取切实可行的措施。

仅适用于非热带气候条件下安全使用

## Taiwan

### Class A Statement

#### 警告使用者

這是甲類的資訊產品，在居住的環境中使用時，可能會造成射頻干擾，在這種情況下，使用者會被要求採取某些適當的對策。

Taiwan Restricted Substances Containment Status (RoHS Declaration) related to this product is available at [www.BradyID.com/i5300compliance](http://www.BradyID.com/i5300compliance).

## Wireless Regulatory Information

Regulatory markings, subject to country certification, are applied to host printer signifying Wi-Fi and Bluetooth (radio) approvals have been obtained.



**WARNING!** Operation of the device without regulatory approval is illegal.

| Radio protocol              | WLAN IEEE 802.11b/g/n  | Bluetooth Classic         |
|-----------------------------|--|---------------------------|
| RF Operating Frequency      | 2.4 – 2.495 GHz  | 2.402 – 2.480 GHz         |
| RF Output Power             | < +20dBm EIRP (100mW)  | < +20dBm EIRP (100mW)     |
| Antenna Type \ Antenna Gain | PCB trace antenna \ -3.06 dBi  | PCB trace antenna \ 1 dBi |
| Environmental Operation     | -40 to 85° C (-40° to 185° F)<br><b>Note:</b> Be mindful of the maximum operating temperatures for the printer. See “System Specifications” on page 2. |                           |
| Environmental Storage       | -55 to 125° C (-67° to 257° F)<br><b>Note:</b> Be mindful of the maximum storage temperatures for the printer. See “System Specifications” on page 2.  |                           |

## United States

**Note:** This equipment has been tested and found to comply with the limits for a Class A digital device, pursuant to part 15 of the FCC Rules. These limits are designed to provide reasonable protection against harmful interference when the equipment is operated in a commercial environment. This equipment generates, uses, and can radiate radio frequency energy and, if not installed and used in accordance with the instruction manual, may cause harmful interference to radio communications.

Operation of this equipment in a residential area is likely to cause harmful interference in which case the user will be required to correct the interference at own expense.

Changes or modifications not expressly approved by the party responsible for compliance could void the user's authority to operate the equipment.

This device complies with Part 15 of the FCC Rules. Operation is subject to the following two conditions: (1) This device may not cause harmful interference and, (2) this device must accept any interference received, including interference that may cause undesired operation.

**Co-located statements:** To comply with FCC RF exposure compliance requirement, the antenna used for this transmitter must not be co-located or operating in conjunction with any other transmitter/antenna except those already with radio module filing.

**RF exposure guidelines:** The radiated output power of this device is far below the radio frequency exposure limits. Nevertheless, to avoid the possibility of exceeding radio frequency exposure limits for an uncontrolled environment, a minimum 20cm distance should be maintained from WiFi radio module PCB antenna (internal) to the head, neck, or body during normal operation.

## Canada

Innovation, Science and Economic Development (ISED)

CAN ICES-3 (A)/NMB-3(A)

This device complies with Industry Canada's license-exempt RSSs. Operation is subject to the following two conditions:

1. This device may not cause interference; and
2. This device must accept any interference, including interference that may cause undesired operation of the device.

**Co-located statements:** To comply with FCC RF exposure compliance requirement, the antenna used for this transmitter must not be co-located or operating in conjunction with any other transmitter/antenna except those already with radio module filing.

**RF exposure guidelines / Important note:** This equipment complies with IC radiation exposure limits set forth for an uncontrolled environment. This equipment should be installed and operated with minimum distance 20cm between the radiator and your body.

## Mexico

IFETEL notice:

"La operación de este equipo está sujeta a las siguientes dos condiciones: (1) es posible que este equipo o dispositivo no cause interferencia perjudicial y (2) este equipo o dispositivo debe aceptar cualquier interferencia, incluyendo la que pueda causar su operación no deseada."

## Brazil

ANATEL notice:   
4208-15-3693  
04841-18-03402

Este equipamento opera em caráter secundário, isto é, não tem direito a proteção contra interferência prejudicial, mesmo de estações do mesmo tipo, e não pode causar interferência a sistemas operando em caráter primário.

Este produto contém a placa model GS2011MIPS, código de homologação ANATEL 4208- 15-3693.

Este produto contém a placa model BT121, código de homologação ANATEL 04841-18-03402.

## European Union

This is a Class A product. In a domestic environment, this product may cause radio interference in which case the user may be required to take adequate measures.

Radio Equipment Directive (RED) 2014/53/EC

- a. Frequency band(s) in which the radio equipment operates; 2.401GHz to 2.483GHz
- b. Maximum radio-frequency power transmitted in the frequency band(s) in which the radio equipment operates; < +20dBm EIRP (100mW)

## International

The Wi-Fi radio module used in Brady host printers comply with internationally recognized standards covering human exposure to electromagnetic fields, i.e. EN 62311 "Assessment of electronic and electrical equipment related to human exposure restrictions for electromagnetic fields (0 Hz - 300 GHz)".

## Japan

MIC \ TELECOM: 006-000263

MIC \ TELECOM: 209-J00171

当該機器には電波法に基づく、技術基準適合証明等を受けた特定無線設備を装着している。

## B Licensing

### End User License Agreement for Microsoft Windows CE<sup>®</sup>

You have acquired a device that includes software licensed by Brady Worldwide, Inc. from Microsoft Licensing or its affiliates (“MS”). Those installed software products of Microsoft origin, as well as associated media, printed materials, and “online” or electronic documentation (“SOFTWARE”) are protected by international intellectual property laws and treaties. The SOFTWARE is licensed, not sold. All rights reserved.

IF YOU DO NOT AGREE TO THIS END USER LICENSE AGREEMENT, DO NOT USE THE DEVICE OR COPY THE SOFTWARE. INSTEAD, PROMPTLY CONTACT BRADY WORLDWIDE, INC. FOR INSTRUCTIONS ON RETURN OF THE UNUSED DEVICE FOR A REFUND. **ANY USE OF THE SOFTWARE, INCLUDING BUT NOT LIMITED TO USE ON THE DEVICE, WILL CONSTITUTE YOUR AGREEMENT TO THIS END USER LICENSE AGREEMENT (OR RATIFICATION OF ANY PREVIOUS CONSENT).**

**GRANT OF SOFTWARE LICENSE:** This End User License Agreement grants you the following license:

You may use the SOFTWARE only on the DEVICE.

**NOT FAULT TOLERANT.** THE SOFTWARE IS NOT FAULT TOLERANT. BRADY WORLDWIDE, INC. HAS INDEPENDENTLY DETERMINED HOW TO USE THE SOFTWARE IN THE DEVICE, AND MS HAS RELIED UPON BRADY WORLDWIDE, INC. TO CONDUCT SUFFICIENT TESTING TO DETERMINE THAT THE SOFTWARE IS SUITABLE FOR SUCH USE.

NO WARRANTIES FOR THE SOFTWARE. **The SOFTWARE is provided “as is” and with all faults. THE ENTIRE RISK AS TO SATISFACTORY QUALITY, PERFORMANCE, ACCURACY, AND EFFORT (INCLUDING LACK OF NEGLIGENCE) IS WITH YOU. ALSO, THERE IS NO WARRANTY AGAINST INTERFERENCE WITH YOUR ENJOYMENT OF THE SOFTWARE OR AGAINST INFRINGEMENT.** IF YOU HAVE RECEIVED ANY WARRANTIES REGARDING THE DEVICE OR THE SOFTWARE, THOSE WARRANTIES DO NOT ORIGINATE FROM, AND ARE NOT BINDING ON, MS.

**Note on Java support.** The SOFTWARE may contain support for programs written in Java. Java technology is not fault tolerant and is not designed, manufactured, or intended for use or resale as online control equipment in hazardous environments requiring fail-safe performances, such as in the operation of nuclear facilities, aircraft navigation or communication systems, air traffic control, direct life support machines, or weapons systems, in which the failure of Java technology could lead directly to death, personal injury, or severe physical or environmental damage. Sun Microsystems, Inc. has contractually obligated MS to make this disclaimer.

**No Liability for Certain Damages.** EXCEPT AS PROHIBITED BY LAW, MS SHALL HAVE NO LIABILITY FOR ANY INDIRECT, SPECIAL, CONSEQUENTIAL OR INCIDENTAL DAMAGES ARISING FROM OR IN CONNECTION WITH THE USE OR PERFORMANCE OF THE SOFTWARE. THIS LIMITATION SHALL APPLY EVEN IF ANY REMEDY FAILS OF ITS ESSENTIAL PURPOSE. IN

NO EVENT SHALL MS BE LIABLE FOR ANY AMOUNT IN EXCESS OF U.S. TWO HUNDRED FIFTY DOLLARS (U.S.\$250.00).

**Limitations on Reverse Engineering, Decompilation, and Disassembly.** You may not reverse engineer, decompile, or disassemble the SOFTWARE, except and only to the extent that such activity is expressly permitted by applicable law notwithstanding this limitation.

**SOFTWARE TRANSFER ALLOWED BUT WITH RESTRICTIONS.** You may permanently transfer rights under this End User License Agreement only as part of a permanent sale or transfer of the Device, and only if the recipient agrees to this End User License Agreement. If the SOFTWARE is an upgrade, any transfer must also include all prior versions of the SOFTWARE.

**EXPORT RESTRICTIONS.** You acknowledge that SOFTWARE is of US-origin. You agree to comply with all applicable international and national laws that apply to the SOFTWARE, including the U.S. Export Administration Regulations, as well as end-user, end-use, and country destination restrictions issued by U.S. and other governments. For additional information on exporting the SOFTWARE, see <http://www.microsoft.com/exporting>.