

# **EK-i/EW-i Series**

## **Compact Balances**

**EK-207/EK-2007/EK-3007/EK-6007**

**EK-2007/EK-20007/EK-30007/EK-60007/EK-12K7**

**EK-4107/EK-6107/EK-41007/EK-61007**

**EW-1507/EW-15007/EW-12K7**

## **INSTRUCTION MANUAL**

---

**© 2011 A&D Company, Limited. All rights reserved.**

No part of this publication may be reproduced, transmitted, transcribed, or translated into any language in any form by any means without the written permission of A&D Company, Limited.

The contents of this manual and the specifications of the instrument covered by this manual are subject to change for improvement without notice.

### **COMPLIANCE WITH FCC RULES**

Please note that this equipment generates, uses and can radiate radio frequency energy. This equipment has been tested and has been found to comply with the limits of Class A computing device pursuant to Subpart J of Part 15 of FCC rules. These rules are designed to provide reasonable protection against interference when the equipment is operated in a commercial environment. If this unit is operated in a residential area it may cause some interference and under these circumstances the user would be required to take, at his own expense, whatever measures are necessary to eliminate the interference.

(FCC = Federal Communications Commission in the U.S.A.)

#### **Note**

Under some ambient electromagnetic conditions, this equipment may be affected by the electromagnetic interference.



This is a hazard alert mark.

---

# CONTENTS

---

<b>1. INTRODUCTION .....</b>	<b>3</b>
<b>2. UNPACKING .....</b>	<b>3</b>
<b>3. PART NAMES AND FUNCTIONS .....</b>	<b>4</b>
<b>4. SETTING UP .....</b>	<b>5</b>
4-1. Setting up your balance .....	5
4-2. Power source.....	5
<b>5. OPERATION.....</b>	<b>6</b>
5-1. Turning the power ON and OFF.....	6
5-2. LCD backlight .....	6
5-3. Units .....	7
5-4. Selecting a weighing unit.....	8
5-5. Basic operation .....	8
5-6. Weighing range for the EW- <i>i</i> series .....	9
5-7. Counting mode (pcs) .....	10
5-8. Percent mode (%).....	11
<b>6. COMPARATOR .....</b>	<b>12</b>
6-1. Setting example.....	12
<b>7. CALIBRATION .....</b>	<b>14</b>
7-1. Calibration using a weight.....	14
7-2. Gravity acceleration correction .....	16
<b>8. FUNCTIONS.....</b>	<b>17</b>
8-1. Key operation .....	17
8-2. Entering the function setting mode .....	17
8-3. Setting example.....	18
8-4. Storing weighing units.....	19
8-5. Function list .....	20
<b>9. RS-232C SERIAL INTERFACE.....</b>	<b>22</b>
9-1. Interface specifications .....	22
9-2. Data format .....	23
9-3. Data output mode .....	23
9-4. Command mode .....	24
<b>10. ID NUMBER AND GLP.....</b>	<b>25</b>
10-1. Setting the ID number.....	25
10-2. GLP report .....	26

<b>11. OPTIONS</b> .....	<b>30</b>
11-1. OP-04 Comparator relay output and buzzer .....	30
11-2. OP-07 Underhook assembly .....	31
11-3. OP-09 Rechargeable battery pack (Ni-MH) .....	32
11-4. OP-12 Carrying case .....	32
<b>12. MAINTENANCE</b> .....	<b>33</b>
12-1. Notes on maintenance.....	33
12-2. Error codes .....	33
<b>13. SPECIFICATIONS</b> .....	<b>35</b>
13-1. EK- <i>i</i> series .....	35
13-2. EW- <i>i</i> series .....	36
13-3. Other weighing units .....	37
13-4. Dimensions .....	38
<b>GRAVITY ACCELERATION MAP</b> .....	<b>39</b>

DOMINIQUE DUTSCHER SAS

---

# 1. INTRODUCTION

---

This manual describes how this balance works and how to get the most out of it in terms of performance.

The EK-*i* and EW-*i* series balances have the following features:

- ❑ The EK-*i* series are high resolution type electronic balances having a resolution of 1/6,000 ~ 1/60,000.
- ❑ The EW-*i* series are triple range balances and each range has a resolution of 1/3,000.
- ❑ The balance has a counting function, % function and a comparator function.
- ❑ The backlight LCD will help with use in a dimly lighted place.
- ❑ The standard RS-232C serial interface can be connected to a printer or personal computer.
- ❑ Using the serial interface, Good Laboratory Practice (GLP) data can be output.
- ❑ The optional rechargeable battery pack (OP-09) is easy to install for cordless operation.

---

## 2. UNPACKING

---

When unpacking, check whether all of the following items are included:

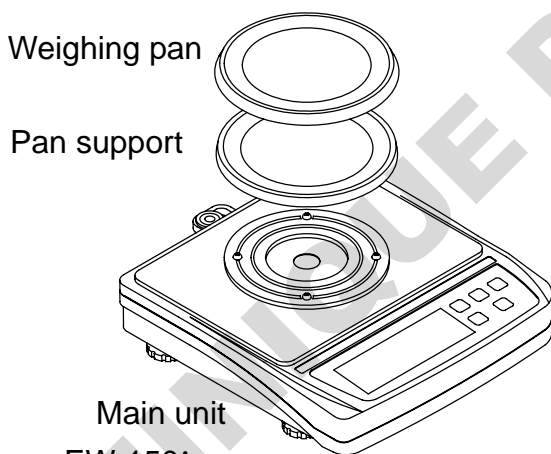

EW-150*i*  
EK-120*i* / EK-200*i* / EK-300*i*  
EK-410*i* / EK-610*i*

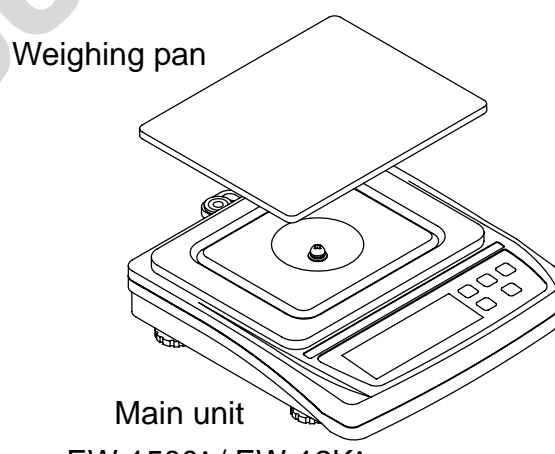

EW-1500*i* / EW-12K*i*  
EK-600*i* / EK-1200*i* / EK-2000*i*  
EK-3000*i* / EK-6000*i* / EK-12K*i*  
EK-4100*i* / EK-6100*i*

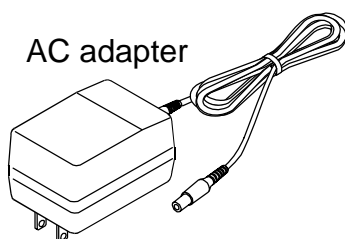

⚠ Please confirm that the AC adapter is correct for your local voltage and receptacle type.

Instruction Manual



# 3. PART NAMES AND FUNCTIONS

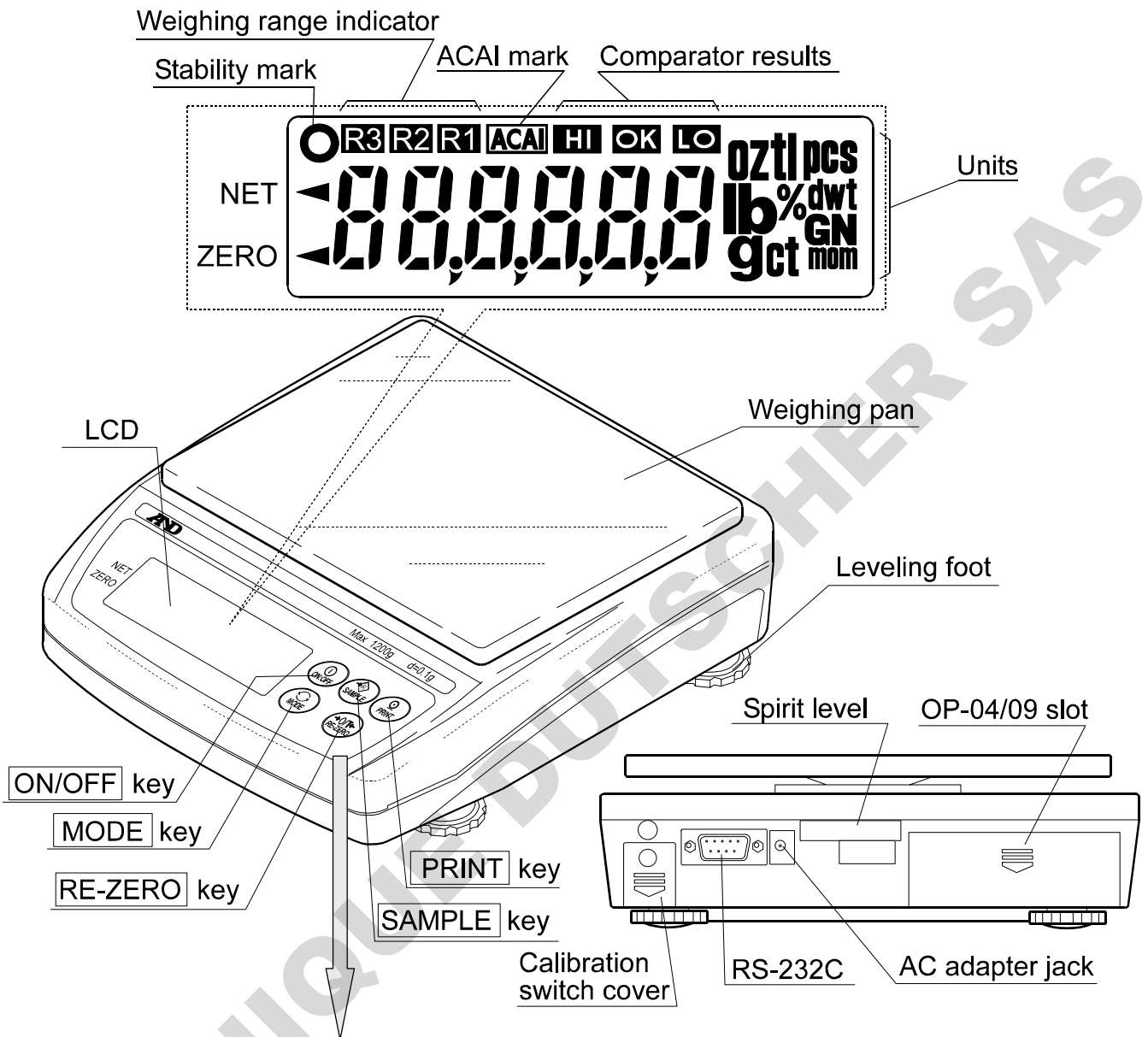

Turns the power on or off.



Held down to enter the function setting mode.

Weighing mode (EW-*i* only):  
Changes the weighing range (when  $r n \bar{0}$  is selected).

pcs mode:  
Enters the sample unit weight storing mode.

% mode:  
Enters the 100% weight storing mode.



Outputs the weight data to a printer or computer, or enters a unit weight, 100% weight or other setting values to the balance.



Switches the weighing unit (the weighing mode).



Clears the display to zero.

---

## 4. SETTING UP

---

### 4-1. Setting up your balance

1. Place the weighing pan on the main unit as shown on the previous page.
2. Adjust the level of the balance using the leveling feet. Use the spirit level to confirm. The bubble should be in the center of the circle.
3. Calibrate your balance before use. (See "7. CALIBRATION")

#### Balance location

To measure correctly, to keep the balance in good condition, and to prevent hazards, observe the following:

- Do not install the balance in locations that are subject to excessive dust, breezes, vibration, large temperature fluctuations, condensation, or that may have magnetic fields.
- Do not install the balance on a surface that is soft or that may cause the balance level to shift.
- Do not install the balance in direct sunshine.
- Do not install the balance near heaters or air conditioners.
- Do not use an unstable AC power source.
- Do not install the balance in a place where combustible or corrosive gases may exist.
- Allow the balance to reach equilibrium with the ambient temperature before use.
- Switch the power ON at least half an hour before use so that the balance can warm up.
- When the balance is installed for the first time, or the balance has been moved, carry out calibration as described in "7. CALIBRATION."

### 4-2. Power source

For the power source, the AC adapter or the rechargeable battery pack (OP-09: Optional item) is available.

#### When using the AC adapter

Use a stable power source. To use the AC adapter, insert the AC adapter plug into the AC adapter jack on the EK/EW-*i*.

#### When using the rechargeable battery pack (OP-09)

Insert the rechargeable battery pack into the main unit.

The balance can be used continuously for about 9 hours using the battery pack.

- If "Lb0" is displayed when using the battery pack, immediately stop using it, and recharge the battery pack or use the AC adapter.***
- See "11-3 OP-09 Rechargeable battery pack", for instructions to install and charge the battery pack.***
- Be sure to charge the battery pack before using it for the first time.***

---

## 5. OPERATION

---

### 5-1. Turning the power ON and OFF

1. Press the  ON/OFF  key to turn the power ON.



All of the symbols are displayed as shown above.  
(About units: Only the units available will be displayed.)

The display turns off except for a weighing unit and the decimal point.  
The balance waits for the weight data to become stable, and zero will be displayed with the ZERO mark (power-on zero).

The range for power-on zero is within  $\pm 10\%$  of the weighing capacity around the calibrated zero point.

If the power is switched ON while there is a load beyond this range, the balance will be tared to zero and the NET mark and the ZERO mark turn on.

2. Pressing the  ON/OFF  key again, and the power will be switched OFF.

#### Auto-power off function

*It is possible to have the power automatically switched OFF, if zero is displayed for approximately 5 minutes. See "8-5. Function list" and set the function "POFF".*

### 5-2. LCD backlight

The LCD backlight will turn on when the weight data changes more than 4 display digits or any key operation is done. When the weight data becomes and stays stable for some moment, the backlight will automatically turn off. There is also a setting that the backlight is always on or off. For details, see the function setting "L LUP" of "Function list".



## 5-3. Units

The most common unit of weight used around the world is the gram, but there is often a need to shift to alternative units specific to the country where the balance is used or to select modes such as counting or percent.

The units and the order they appear in the display are as follows:

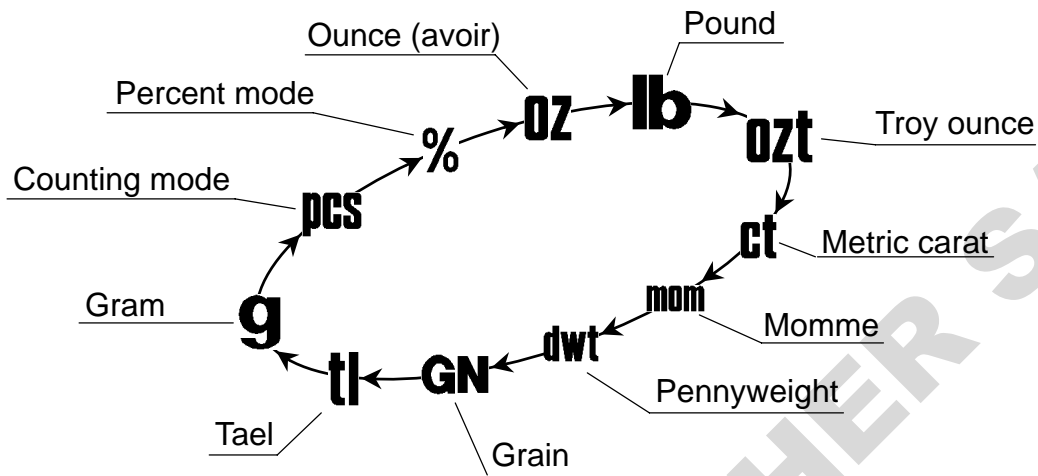

Among the units, those available for the user have been set at the factory before shipping.

The unit can be selected in the function setting mode. The order of the units available is the same as above, while skipping the units that are not available.

Some units are not available for higher or lower capacity models. For details, see “13. SPECIFICATIONS”

### □ Note

*It is possible to store only the units that will be actually used from the units available. It is also possible to specify the display unit that will be shown first when the power is switched ON. For details, see “8-4. Storing weighing units”.*

### Conversion table

Units	Name	Conversion to gram
oz	Ounce (avoir)	28.349523125 g
lb	Pound (UK)	453.59237 g
ozt	Troy ounce	31.1034768 g
ct	Metric carat	0.2 g
mom	momme	3.75 g
dwt	Pennyweight	1.55517384 g
GN	Grain (UK)	0.06479891 g
tl	tael (Hong Kong general, Singapore)	37.7994 g

### □ Note

*The unit “tl (tael)” is for special versions only.*

## 5-4. Selecting a weighing unit

Press the **MODE** key to select a unit.

The following sections are a description of the three common units: g (gram mode), pcs (counting mode), and % (percent mode).

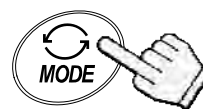

Each pressing switches the units available in the order described on the previous page.

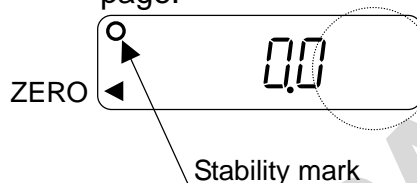

## 5-5. Basic operation

1. Select a weighing unit.
2. When the display doesn't show zero, press the **RE-ZERO** key to set the display to zero.
3. When using a tare (container), place the container on the weighing pan, and press the **RE-ZERO** key to set the display to zero.
4. Place the object to be weighed on the pan or in the container.  
Wait for the stability mark ( ○ ) to be displayed and read the value.
5. Remove the object from the pan.

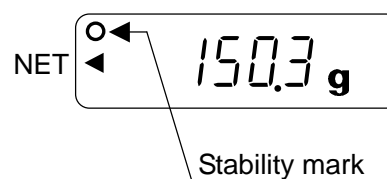
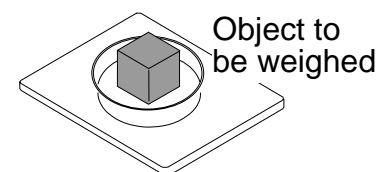
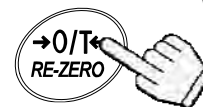
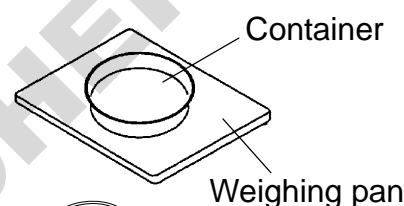

### Note

**The RE-ZERO key will zero the balance if the weight is within  $\pm 2\%$  of the weighing capacity around the power-on zero point. The ZERO mark ◀ turns on. When the weight exceeds  $+2\%$  of the weighing capacity, it will be subtracted to zero as a tare weight. In this case the ZERO and NET marks turn on.**

## Precautions during operation

- Make sure that the stability mark is on whenever reading or storing a value.
- Do not press the keys with a sharp object such as a pencil.
- Do not apply a shock or a load to the pan that is beyond the weighing capacity.
- Keep the balance free from foreign objects such as dust or liquid.
- Calibrate the balance periodically to keep weighing accuracy. (See "7. CALIBRATION".)

## 5-6. Weighing range for the EW-i series

- The EW-i series have three weighing ranges, and the display shows which range the weight value belongs to with the mark R1, R2 or R3.
- There is a function setting to select how the weighing range changes.
- Select from automatic range (range 1), manual range (range 0) or fixed range (range 2 to 4).

### Operation

Function setting	Operation
range 1	<p>Automatic range</p> <ul style="list-style-type: none"> <li><input type="checkbox"/> When the weight value exceeds the maximum value of the range, the weighing range changes automatically from a lower to a higher weighing range.</li> <li><input type="checkbox"/> When there is nothing on the weighing pan and the display shows zero with the ZERO mark, the weighing range changes from a higher to the lowest range.</li> <li><input type="checkbox"/> When the <b>RE-ZERO</b> key is pressed in a higher range, the balance will be tared to zero and the weighing range changes to the lowest range.</li> </ul>
range 0	<p>Manual range</p> <ul style="list-style-type: none"> <li><input type="checkbox"/> Press the <b>SAMPLE</b> key when the display shows a weight value (neither counting nor % display). The weighing range changes to a higher range at any load.</li> <li><input type="checkbox"/> Press the <b>SAMPLE</b> key to change from a higher to the lowest range, when there is nothing on the weighing pan and the display shows zero with the ZERO mark.</li> <li><input type="checkbox"/> When the <b>RE-ZERO</b> key is pressed in a higher range, the balance will be tared to zero and the weighing range changes to the lowest range. If the weight of the object is not more than 2% of the weighing capacity, the <b>RE-ZERO</b> key doesn't tare, but zeroes the balance and the weighing range doesn't change. Press the <b>SAMPLE</b> key to change the weighing range at zero display.</li> </ul>
range 2 to 4	<p>Fixed range (*)</p> <ul style="list-style-type: none"> <li><input type="checkbox"/> The weighing range is fixed. Set the function to the weighing range according to the purpose.</li> </ul>

(\*) This function will not be available for some of legally certified models.

## 5-7. Counting mode (pcs)

Determines the number of objects in a sample. Calculates the reading, using the basic sample unit weight, and determines how many pieces are contained.

### Selecting the counting mode

1. Press the **MODE** key to select **PCS**.  
(**PCS** :pieces)

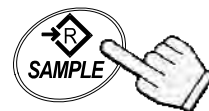
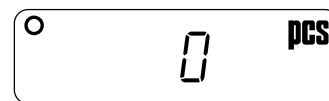

### Storing the sample unit

2. Press the **SAMPLE** key to enter the sample unit weight storing mode.



Switches the number of samples.

3. To select the number of samples, press the **SAMPLE** key. It may be set to 5, 10, 25, 50, or 100.

4. Place a tare container on the weighing pan, and press the **RE-ZERO** key. Confirm that the right side of the number of samples shows zero.

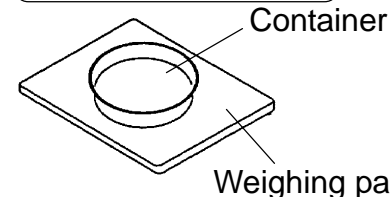
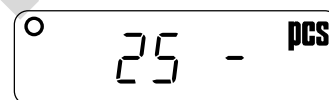

5. Place the number of samples specified on the pan. In this example, 25 pieces.

6. Press the **PRINT** key to calculate and store the unit weight. Remove the sample. The balance is set to count objects with this unit weight.



Confirm the display

- When a unit weight is too light to store, the display shows **Lo** for a moment and returns to the former display. When the sample weight is light and the counting error could become large, the balance will prompt you to use a larger number of samples. Place the displayed number of samples on the pan and press the **PRINT** key to calculate and store the unit weight.

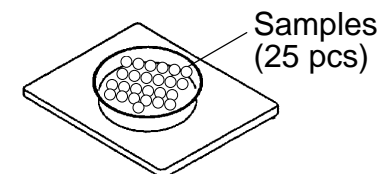
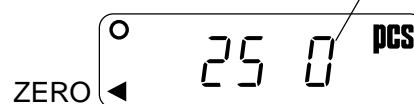

See also "Sample quantity notice" and "Unit weight error" of "12-2. Error codes".

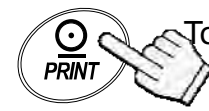

To store

### Counting the objects

7. Place the objects to be counted on the pan.

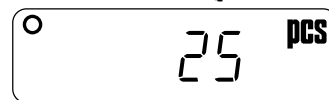

### Counting mode using the ACAI function

ACAI™ (Automatic Counting Accuracy Improvement) is a function that improves the accuracy of the unit weight by increasing the number of samples as the counting process proceeds.

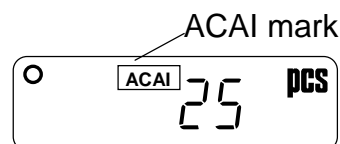

8. After setting the unit weight at step 6, add a few more samples on the pan. Then, the ACAI mark will turn on. (Add more than three pieces. The mark will not turn on for the number of samples beyond the ACAI range.)
9. The ACAI mark will blink and the balance re-calculates the unit weight. Do not touch the balance or samples on the pan until the ACAI mark turns off.
10. Counting accuracy is improved when the ACAI mark turns off. Each time the above operation is performed, a more accurate unit weight will be obtained. There is no definite upper limit of ACAI range for the number of samples exceeding 100. Try to add the similar number of samples as displayed.

## 5-8. Percent mode (%)

Displays the weighing value in percentage compared to the reference (100%) weight.

### Selecting the percent mode

1. Press the **MODE** key to select **%**. (%:percent)



### Storing the reference (100%) weight

2. Press the **SAMPLE** key to enter the reference weight storing mode.

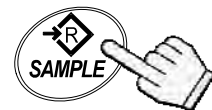

3. Press the **RE-ZERO** key to display **100 0%**.



4. Place the sample to be set as the reference weight on the pan.

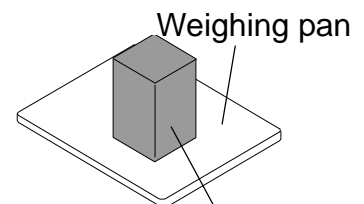

5. Press the **PRINT** key to store the reference weight. Remove the sample.

- When the reference weight is too light, the display shows **Lo** for a moment and returns to the former display.



### Reading the percentage

6. Place the object to be compared to the reference weight on the pan. The displayed percentage is based on 100% of the reference weight.

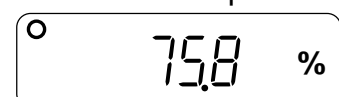
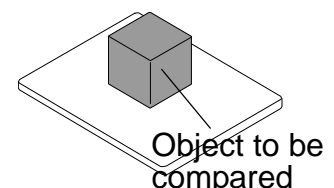

# 6. COMPARATOR

The results of the comparison are indicated by HI, OK or LO on the display.  
The comparison is as follows:

$$LO < \text{Lower limit value} \leq OK \leq \text{Upper limit value} < HI$$

Operating conditions (see the function setting "[P]"):

- No comparison (comparator function disabled).
- Compares all data.
- Compares all stable data.
- Compares plus data except those near zero (plus data greater than +4d).
- Compares stable plus data except those near zero (stable plus data greater than +4d).
- Compares all data except those near zero (all data greater than +4d or less than -4d).
- Compares stable data except those near zero (stable data greater than +4d or less than -4d).

d = the smallest display division  
e.g.: 4d=four display divisions

The upper limit and lower limit numerical values are common to each of the weighing, counting and percent mode. An example for the EK-1200i/2000i/3000i is as follows.

Upper limit value "001010": "101.0g" "1010pcs" "101.0%"  
Lower limit value "000990": "99.0g" "990pcs" "99.0%"

## 6-1. Setting example

This example will be "Compares plus data except those near zero".

### Selecting a comparison mode

1. Press and hold the **SAMPLE** key to display **Func**.  
(If the comparison mode is already set, press the **SAMPLE** key to go to "Entering the upper and lower
2. Press the **PRINT** key, then the balance displays **PoFF X**.
3. Press the **SAMPLE** key several times to display **[P X]**.
4. Press the **RE-ZERO** key several times to display **[P 3]**.
5. Press the **PRINT** key to store the settings.  
**[P Hi]** appears after **End**.

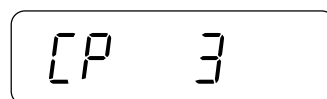
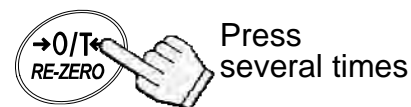
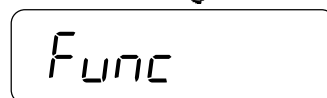

## Entering the upper and lower limit values

6. With **[P H<sub>i</sub>]** displayed, press the **[PRINT]** key. Enter the upper limit value using the following keys.

**[SAMPLE]** key To select the digit blinking to change.

**[RE-ZERO]** key To set the value of the digit selected. Hold down the key to switch the sign “+” and “-”. (“N” designates a negative value.)

**[PRINT]** key To store the value and proceed to the next step.

**[MODE]** key To cancel the value and proceed to the next step.

**[P H<sub>i</sub>]**

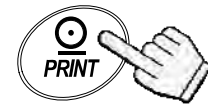

**[RE-ZERO]** key To set the value of the digit selected. Hold down the key to switch the sign “+” and “-”. (“N” designates a negative value.)

Set using the relevant keys

**[PRINT]** key To store the value and proceed to the next step.



To store

7. With **[P L<sub>o</sub>]** displayed, press the **[PRINT]** key. Enter the lower limit value using the following keys.

**[SAMPLE]** key To select the digit blinking to change.

**[RE-ZERO]** key To set the value of the digit selected. Hold down the key to switch the sign “+” and “-” (see step 6).

**[PRINT]** key To store the value and proceed to the next step.

**[MODE]** key To cancel the value and proceed to the next step.

**[P L<sub>o</sub>]**



**[RE-ZERO]** key To set the value of the digit selected. Hold down the key to switch the sign “+” and “-” (see step 6).

Set using the relevant keys

**[PRINT]** key To store the value and proceed to the next step.

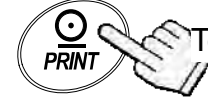

To store

8. Press the **[PRINT]** key. **[Unit]** appears after **[End]**.

**[End]**

**[Unit]**

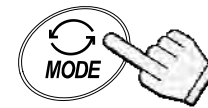

Returns to the weighing mode

9. Press the **[MODE]** key to return to the weighing mode.

# 7. CALIBRATION

This function adjusts the balance for accurate weighing. Perform calibration in the following cases.

- When the balance is first used.
- When the balance has been moved.
- When the ambient environment has changed.
- For regular calibration.

Press and lower the calibration switch cover

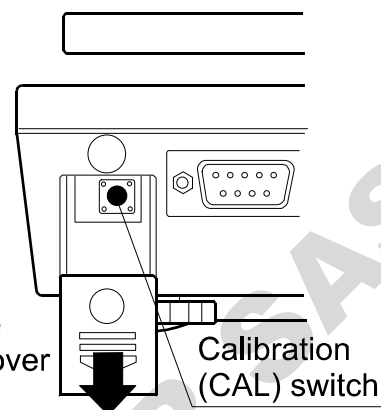

## 7-1. Calibration using a weight

- Prepare a calibration weight (optional) before start.

1. Warm up the balance for at least half an hour with nothing on the pan.



Press and hold the CAL switch.

2. Press and hold the calibration (CAL) switch until **CAL** appears, and release the switch.

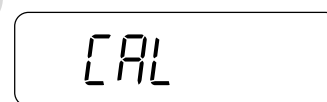

Release the CAL switch.

3. The balance displays **CAL 0**.

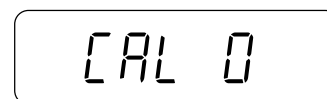

To change the calibration weight value, proceed to step 4.

To use the calibration weight value in the balance memory, proceed to step 5.

4. Press the **SAMPLE** key. The display shows the calibration weight value in "gram" that is stored in the balance. Use the following keys to change the value.

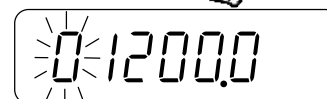

Set the weight using the relevant keys.

**SAMPLE** key To select the digit blinking to change.

**RE-ZERO** key To set the value of the digit selected.

**PRINT** key To store the value and return to step 3.

**MODE** key To cancel the value and return to step 3.

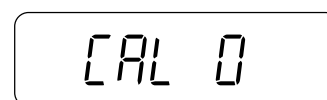
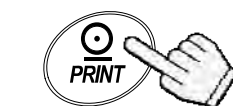

- Use a calibration weight of more than 2/3 of the capacity (of the highest range for EW-*i* series).



5. At step 3, pressing the **PRINT** key weighs the zero-point value. Do not touch the pan during weighing.

When the zero calibration is completed, the display shows the calibration weight value.

- To perform the zero calibration only and finish the procedure, press the **MODE** key.

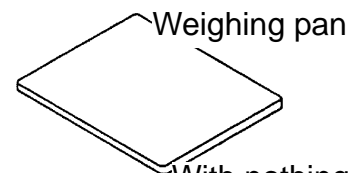

With nothing on the pan



6. Place the calibration weight with the same value as displayed on the pan. Press the **PRINT** key to weigh it. Do not touch the pan during weighing.

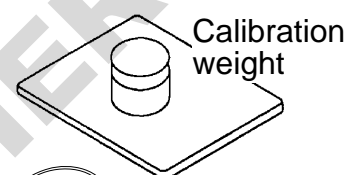

7. **End** appears.

Remove the weight from the pan, and press the CAL switch or **MODE** key to return to the weighing mode.

**Note**

**The value set in step 4 is stored in memory even after the power is switched off.**

**If the balance is to be moved to other places, set the gravity acceleration value of the area where the calibration using a weight is to be done, and calibrate the balance according to the procedure above. See the next section to set the value.**

## 7-2. Gravity acceleration correction

When the balance is first used or has been moved to a different place, it should be calibrated using a calibration weight.

But if the calibration weight cannot be prepared, the gravity acceleration correction will compensate the balance. Change the gravity acceleration value of the balance to the value of the area where the balance will be used. See the gravity acceleration map appended to the end of this manual.

### □ Note

**Gravity acceleration correction is not required when the balance is calibrated using a calibration weight at the place where the balance is to be used.**

1. Press and hold the calibration (CAL) switch until  appears, and release the switch.



Press and hold the CAL switch.

2. The balance displays .



3. Press the  key.

The display shows the gravity acceleration value stored in the balance.

Use the following keys to change the value.

 key To select the digit blinking to change.

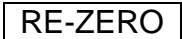
 key To set the value of the digit selected.

 key To store the value and return to step 2.

 key To cancel the value and return to step 2.

Release the CAL switch.

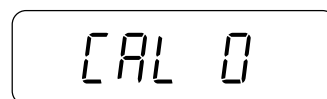

Set the value using the relevant keys.



To store

4. After setting the value, press the  key.

 is displayed again.

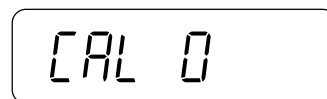

5. If it is necessary to calibrate the balance using a calibration weight, go to step 4 of 7-1.

To finish the setting, press  key.

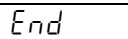

Returns to the weighing mode

6.  appears and the balance returns to the weighing mode.

# 8. FUNCTIONS

## 8-1. Key operation

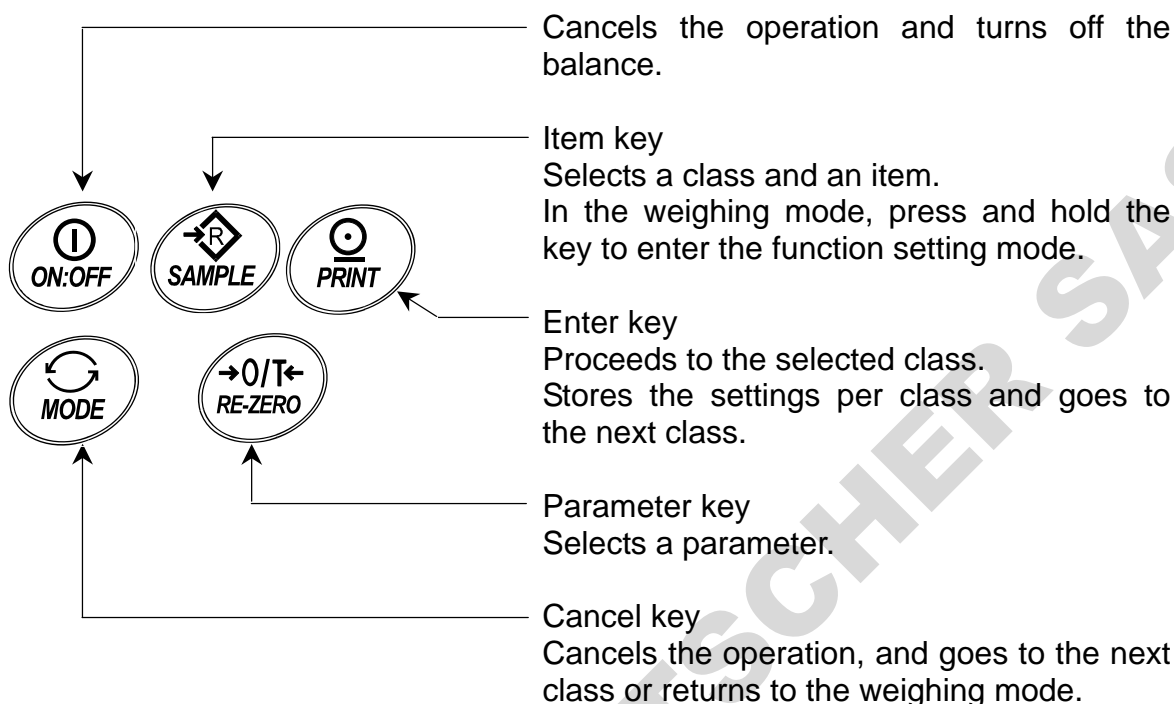

## 8-2. Entering the function setting mode

In the weighing mode, press and hold the **SAMPLE** key to enter the function setting mode and display **Func**. Each time the **SAMPLE** key is pressed, the class appears one after another.

Once the class is selected, the set items are available for selection. (See "Function list".)

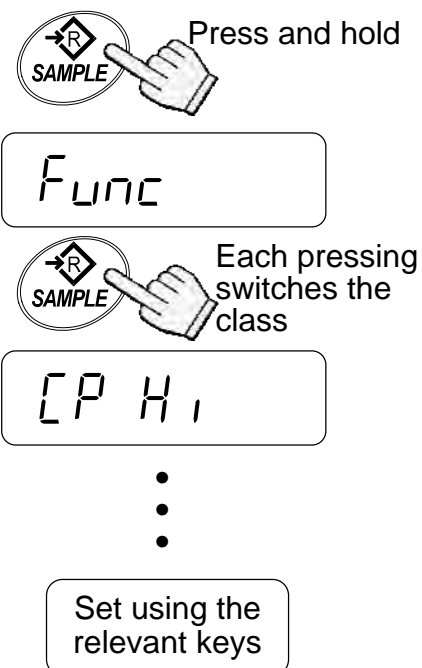

### 8-3. Setting example

To set auto power-off function to “Enabled”, and the ACAI function to “Disabled”.

1. Press and hold the **SAMPLE** key to display **Func**.



2. Press the **PRINT** key. The balance displays **PoFF 0**.

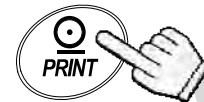

3. Press the **RE-ZERO** key to display **PoFF 1**.

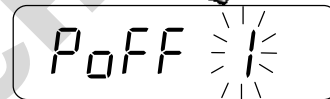
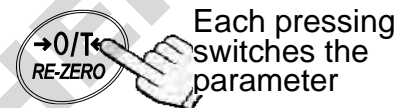

4. Press the **SAMPLE** key several times to display **ACA, 1**.

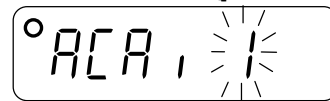

5. Press the **RE-ZERO** key to select **ACA, 0**.

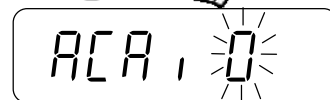
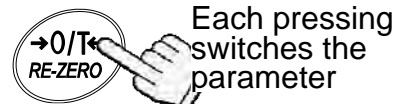

6. Press the **PRINT** key to store the parameters. **CPH,** appears after **End**.

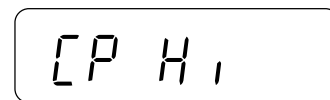
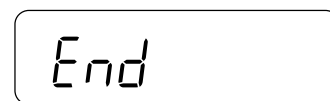

7. Press the **MODE** key to return to the weighing mode.

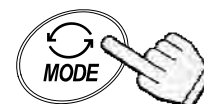

Returns to the weighing mode

## 8-4. Storing weighing units

It is possible to store the weighing units that will be actually used from the units available. For the units available, see "5-3. Units"

Select and store the weighing units as described below:

1. Press and hold the **SAMPLE** key to display **Func**.

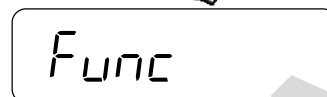

2. Press the **SAMPLE** key several times to display **Unit**.



3. Press the **PRINT** key.

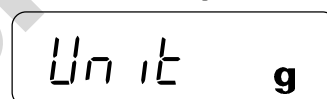
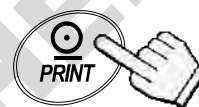

4. Press the **SAMPLE** key to select a weighing unit.

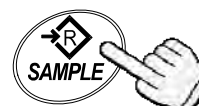

Each pressing switches the units available in the order described on 5-3.

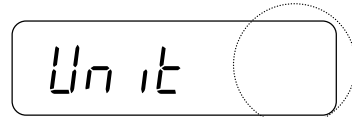

5. Press the **RE-ZERO** key to store the weighing unit.



6. Repeat steps 4. and 5. to store all weighing units to be used.

7. Press the **PRINT** key. **id** appears after **End**.

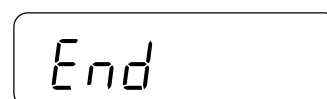

8. Press the **MODE** key to return to the weighing mode.

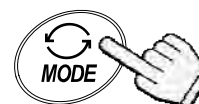

Returns to the weighing mode

### □ Note

**When the balance is switched on, it starts with the unit that was stored first at step 5.**

## 8-5. Function list

Class	Item	Parameter	Description	
Func	P <sub>OFF</sub> Auto power-off	◆ 0	Auto power-off disabled	Automatically power off
		1	Auto power-off enabled	
	r <sub>NG</sub> Range	0	Manual range change	Range change setting for EW-i series
		◆ 1	Automatic range change	
		2	Fixed to the lowest range	
		3	Fixed to the middle range	
		4	Fixed to the highest range	
	f <sub>ond</sub> Response	0	Fast / sensitive  Slow / stable	Software filtering
		1		
		◆ 2		
		3		
		4		
	St-b Stability band width	0	Stable when within ± 0.5d/0.5s	Conditions to turn on the stability mark
		◆ 1	Stable when within ± 1d/0.5s	
		2	Stable when within ± 2d/0.5s	
	t <sub>rc</sub> Zero tracking	0	Disabled	Tracking zero shift
		◆ 1	Enabled	
	P <sub>nt</sub> Decimal point	◆ 0	Point (.)	Decimal separator
		1	Comma (,)	
	[P Comparator mode	◆ 0	Comparator disabled	Conditions to compare. d = the minimum display division
		1	Compares all data	
		2	Compares all stable data	
		3	Compares plus data > +4d	
		4	Compare stable plus data > +4d	
		5	Compares data > +4d or < -4d	
	bEP Buzzer output	◆ 0	Buzzer does not sound.	Buzzer sounds according to the comparator results
		1	Buzzer sounds at LO.	
		2	Buzzer sounds at OK.	
		3	Buzzer sounds at OK and LO.	
		4	Buzzer sounds at HI.	
		5	Buzzer sounds at HI and LO.	
		6	Buzzer sounds at HI and OK.	
7		Buzzer sounds at HI, OK and LO.		
P <sub>rt</sub> Data output mode	0	Command and stream modes	Auto-print A: + data Auto-print B: +/- data	
	◆ 1	Command and PRINT key		
	2	Command, PRINT key and auto-print A		
	3	Command, PRINT key and auto-print B		
	4	Command mode only		
P <sub>USE</sub> Data output pause	◆ 0	No pause (general equipment)	Interval between continuous data	
	1	1.6 seconds (for AD-8121)		
inF <sub>o</sub> GLP output	◆ 0	No output	GLP output format	
	1	AD-8121 format		
	2	General format		
bP <sub>S</sub> Baud rate	◆ 0	2400 bps		
	1	4800 bps		
	2	9600 bps		
	3	1200 bps		

◆ Factory setting

Class	Item	Parameter	Description	
<i>F<sub>unc</sub></i>	<i>btPr</i> Data and parity	◆ 0	7 bits, even parity	
		1	7 bits, odd parity	
		2	8 bits, non parity	
	<i>ACR<sub>i</sub></i> ACAI function	0	ACAI disabled	If "0" is set, no additional samples required.
		◆ 1	ACAI enabled	
	<i>Un<sub>in</sub></i> Minimum unit weight	◆ 0	1 d	d = the minimum display division
		1	1/8 d	
		2	total sample weight ≥ 5d <sup>(*)</sup>	
	<i>SnPL</i> Sample number	◆ 0	10 pcs	The number of samples shown first when entered into the unit weight storing mode
		1	25 pcs	
		2	50 pcs	
		3	100 pcs	
		4	5 pcs	
	<i>LEUP</i> LCD Backlight control	0	Always off	To control how the LCD backlight turns off. Weight change or key operation will turn the backlight on.
		1	Turns off after 5 seconds	
		2	Turns off after 10 seconds	
		◆ 3	Turns off after 30 seconds	
		4	Turns off after 60 seconds	
	5	Always on		
	<i>CPH<sub>i</sub></i>	Comparator upper limit		Setting the upper limit value
<i>CPL<sub>o</sub></i>	Comparator lower limit		Setting the lower limit value	"6. COMPARATOR"
<i>Unit</i>	Weighing units to be displayed		Sets to display units	See "8-4. Storing weighing units"
<i>id</i>	ID number for GLP output		Sets the ID number	See "10. ID NUMBER AND GLP"

◆ Factory setting

(\*) Even if the weight display is "5d", there may be a range that it is not accepted. This is because the weight display data is rounded off internally.

# 9. RS-232C SERIAL INTERFACE

This interface allows the EK/EW-*i* series to be connected with a multifunction printer or a personal computer.

- ❑ The RS-232C interface has the following four modes.
  - Stream mode            Outputs data continuously.
  - Key mode                Outputs data by pressing the PRINT key.
  - Auto-print mode        Outputs data which meets the conditions of auto-print.
  - Command mode         Controls the balance using commands from a computer.
- ❑ Set the parameters of the data format ( $b^P_r$  and  $b_t^P_r$ ) and data output mode ( $P_r t$ ), as necessary.
- ❑ Use a D-sub 9 pin cable (straight type) to connect with a computer.
- ❑ Windows Communication Tools Software (WinCT) to communicate with a computer is provided as freeware. Visit the A&D website to download WinCT.

## 9-1. Interface specifications

Transmission system	EIA RS-232C
Transmission form	Asynchronous, bi-directional, half-duplex
Data format	Baud rate: 1200, 2400, 4800, 9600 bps
	Data: 7 bits + parity 1 bit (even or odd) or 8 bits (non-parity)
	Start bit: 1 bit
	Stop bit: 1 bit
	Code: ASCII
	Terminator: C <sub>R</sub> L <sub>F</sub> (C <sub>R</sub> : 0Dh, L <sub>F</sub> : 0Ah)

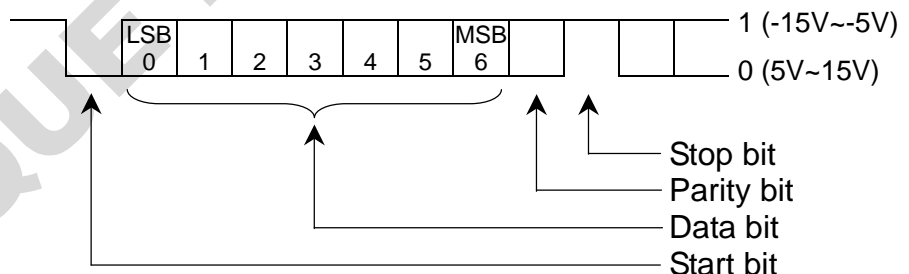

Pin connections

D-sub 9pin male connector

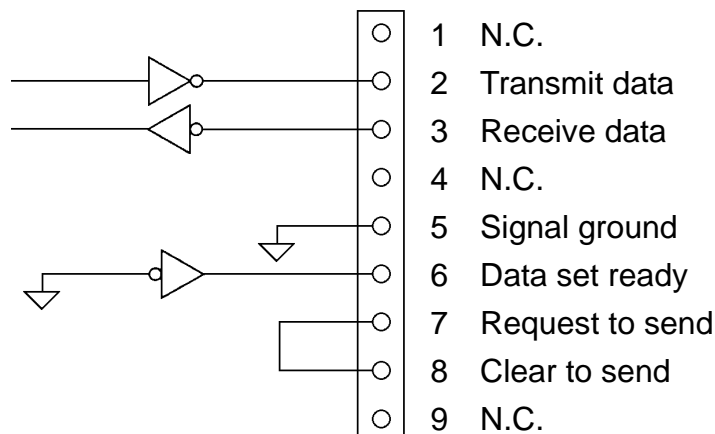

Inside of the EK/EW-*i*



## 9-2. Data format

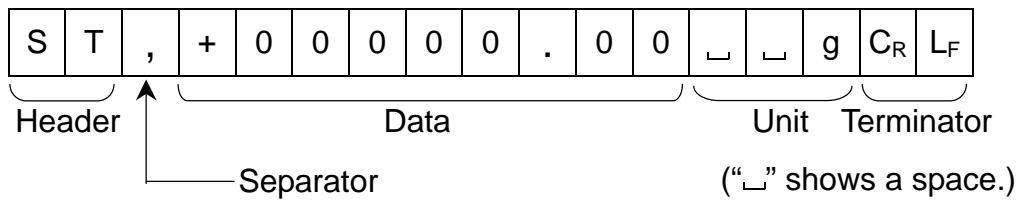

- ❑ There are four types of headers:
  - ST : Stable weight data (including % data)
  - QT : Stable counting data
  - US : Unstable weight data (including count and %)
  - OL : Out of weighing range (Over)

- ❑ The data is normally 9 digits including a decimal point and a sign.

- ❑ There are 11 types of units:
  - \_ \_ g : Weight data “gram”
  - \_ P C : Counting data “pcs”
  - \_ \_ % : Percentage data “%”
  - \_ o z : Weight data “decimal ounce”
  - \_ l b : Weight data “decimal pound”
  - o z t : Weight data “troy ounce”
  - \_ c t : Weight data “carat”
  - mom : Weight data “momme”
  - d w t : Weight data “penny weight”
  - \_ GN : Weight data “grain”
  - \_ t l : Weight data “tael”

- ❑ The terminator is always C<sub>R</sub>L<sub>F</sub>.

- ❑ Example of output data:

Weight data “gram”

S	T	,	+	0	0	1	2	3	4	.	5	_	_	g	C <sub>R</sub>	L <sub>F</sub>
---	---	---	---	---	---	---	---	---	---	---	---	---	---	---	----------------	----------------

Counting data

Q	T	,	+	0	0	0	1	2	3	4	5	_	P	C	C <sub>R</sub>	L <sub>F</sub>
---	---	---	---	---	---	---	---	---	---	---	---	---	---	---	----------------	----------------

Percentage data

S	T	,	+	0	0	0	1	2	3	.	4	_	_	%	C <sub>R</sub>	L <sub>F</sub>
---	---	---	---	---	---	---	---	---	---	---	---	---	---	---	----------------	----------------

Out of range “gram” (+)

O	L	,	+	9	9	9	9	9	9	.	9	_	_	g	C <sub>R</sub>	L <sub>F</sub>
---	---	---	---	---	---	---	---	---	---	---	---	---	---	---	----------------	----------------

Out of range “pcs” (-)

O	L	,	-	9	9	9	9	9	9	9	9	_	P	C	C <sub>R</sub>	L <sub>F</sub>
---	---	---	---	---	---	---	---	---	---	---	---	---	---	---	----------------	----------------

## 9-3. Data output mode

### Stream mode

Set the function “Prt 0”.

The balance outputs the current display data. The data-update rate is approximately 10 times per second. This rate is the same as the display-update.

The balance does not output data while it is in the setting mode.

## Key mode

Set the function "Print 1, 2 or 3".

When the **PRINT** key is pressed while the weight data is stable (the stability mark is on), the balance transmits the data. When the data is transmitted, the display will blink one time.

## Auto-print mode A

Set the function "Print 2".

The balance transmits the weight data when the display is stable (the stability mark is on) and the data is greater than +4d (of the lowest range for EW-i series).

The next output can be obtained after the display returns below +4d.

## Auto-print mode B

Set the function "Print 3".

The balance transmits the weight data when the display is stable (the stability mark is on) and the data is greater than +4d (of the lowest range for EW-i series) or less than -4d.

The next output can be obtained after the display returns between -4d and +4d.

## 9-4. Command mode

In the command mode, the balance is controlled by commands that come from the personal computer and so on.

### Command list

- Command to request the current weight data.

Command 

Q	C <sub>R</sub>	L <sub>F</sub>
---	----------------	----------------

Reply 

S	T	,	+	0	0	1	2	3	4	.	5	□	□	g	C <sub>R</sub>	L <sub>F</sub>
---	---	---	---	---	---	---	---	---	---	---	---	---	---	---	----------------	----------------

- Command to zero or tare the balance (same as the **RE-ZERO** key).

Command 

Z	C <sub>R</sub>	L <sub>F</sub>
---	----------------	----------------

Reply 

Z	C <sub>R</sub>	L <sub>F</sub>
---	----------------	----------------

- Command to change the weighing units (same as the **MODE** key).

Command 

U	C <sub>R</sub>	L <sub>F</sub>
---	----------------	----------------

Reply 

U	C <sub>R</sub>	L <sub>F</sub>
---	----------------	----------------

# 10. ID NUMBER AND GLP

The ID number is used to identify the balance when Good Laboratory Practice (GLP) is used. The following GLP data is transmitted to an AD-8121 printer or a computer using the RS-232C interface.

- The result of calibration (“Calibration report”)
- The result of calibration test (“Calibration test report”)
- The “Start block” and “End block” for GLP data

## 10-1. Setting the ID number

1. Press and hold the **SAMPLE** key to display **Func**.



2. Press the **SAMPLE** key several times to display **id**.



3. Press the **PRINT** key. Enter the ID number using the following keys.

**SAMPLE** key To select the digit blinking to change.

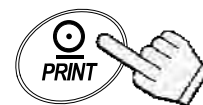

**RE-ZERO** key To set the character of the digit selected. See the table below for the “display character set”.



**PRINT** key To store the value and proceed to the next step.

Set using the relevant keys

**MODE** key To cancel the value and proceed to the next step.



4. When the above operation has completed, **Func** appears after **End**.

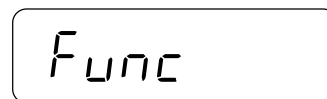

5. Press the **MODE** key to return to the weighing mode.



Returns to the weighing mode

### Display character set

0	1	2	3	4	5	6	7	8	9	-	_	A	B	C	D	E	F	G	H	I	J	K	L	M	N	O	P	Q	R	S	T	U	V	W	X	Y	Z
0	1	2	3	4	5	6	7	8	9	-	_	A	B	C	D	E	F	G	H	I	J	K	L	M	N	O	P	Q	R	S	T	U	V	W	X	Y	Z

“\_” : Space

## 10-2. GLP report

- ❑ To print the GLP report to the AD-8121B, select the function setting “*info 1*” and “*PULSE 1*” for the balance, and use MODE 3 of the printer.
- ❑ To transmit the GLP report to a personal computer, select the function setting “*info 2*” and “*PULSE 0*”.
- ❑ The serial number attached to the lateral side of the balance may have a form “#Q1234567” (# = I, E and so on). In this case, the first letter “#” is ignored as a GLP data and output data has a form “Q1234567”.

### Calibration report

- ❑ This function is not available after sealing the calibration (CAL) switch.

1. Perform calibration according to “7-1. Calibration using a weight”.

2. End appears when the calibration has been completed.

3. GLP is displayed and calibration report is output.

4. End appears again. Remove the weight and press the MODE key to return to the weighing mode.

Operation of Calibration  
(See “7.CALIBRATION”)

End

°  
GLP

→ To output calibration report

End



Returns to the weighing mode

AD-8121 format “*info 1*”

```

      A & D
MODEL  EK-1200i
S/N    Q1234567
ID     ABCDEF
DATE   2011/11/14
TIME   02:53:21
CALIBRATED(EXT.)
CAL.WEIGHT
      +1000.0  9
SIGNATURE
-----
```

← Manufacturer →

← Model →

← Serial number →

← ID number →

← Date →

← Time →

← Calibration executed →

← Calibration weight →

← Column for signature →

General format “*info 2*”

```

.....A&D<CRLF>
MODEL...EK-1200i<CRLF>
S/N.....Q1234567<CRLF>
ID.....ABCDEF<CRLF>
DATE<CRLF>
<CRLF>
TIME<CRLF>
<CRLF>
CALIBRATED(EXT.)<CRLF>
CAL.WEIGHT<CRLF>
.....+1000.0...g<CRLF>
SIGNATURE<CRLF>
<CRLF>
<CRLF>
----- <CRLF>
<CRLF>
<CRLF>
```

␣ : Space, ASCII 20h  
CR: Carriage return, ASCII 0Dh  
LF: Line feed, ASCII 0Ah

## Calibration test report

The calibration test mode is used to compare a calibration test weight with the calibration test data weighed by the balance.

- ❑ This test does not perform calibration and this mode is available even after sealing the calibration (CAL) switch.

1. Press and hold the **SAMPLE** and **PRINT** keys. **[[** will appear. Then, release both keys.

- ❑ Pressing and holding the calibration (CAL) switch will also display **[[** after **CAL**. Then, release the CAL switch while showing **[[**.

2. **[[ 0** is displayed.

3. If necessary, change the value of calibration test weight according to the procedure step 4 of "7-1. Calibration using a weight".

4. With nothing on the pan, press the **PRINT** key. The zero point is measured and the weighed value is displayed for a few seconds. Then, the display shows the value of calibration test weight.

5. Place a weight of the same value as displayed on the pan and press the **PRINT** key to weigh it. The weighed value is displayed for a few seconds.

6. **End** appears.

7. **GLP** is displayed and calibration test report is output.

8. **End** appears again. Remove the weight and press the **MODE** key to return to the weighing mode.



Press and hold both keys.



Release both keys.

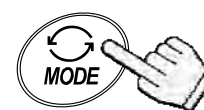
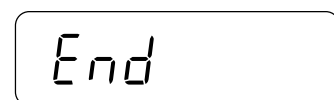
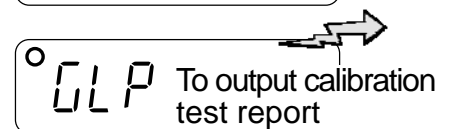
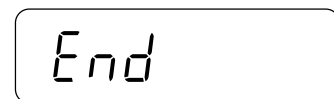
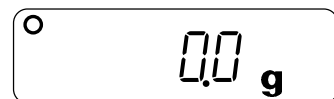
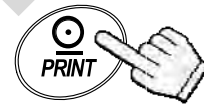
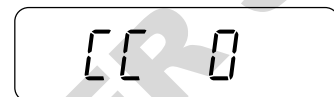

Returns to the weighing mode

### AD-8121 format "inFo 1"

```

      A & D
MODEL  EK-1200i
S/N    01234567
ID     ABCDEF
DATE   2011/11/14
TIME   03:15:40
CAL. TEST(EXT.)
ACTUAL
      0.0  g
      +1000.1  g
TARGET
      +1000.0  g
SIGNATURE
-----
    
```

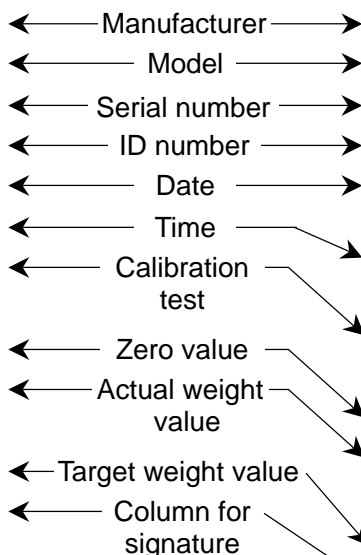

### General format "inFo 2"

```

_____A.&D<CRLF>
MODEL___EK-1200i<CRLF>
S/N_____01234567<CRLF>
ID_____ABCDEF<CRLF>
DATE<CRLF>
<CRLF>
TIME<CRLF>
<CRLF>
CAL. TEST (EXT. )<CRLF>
ACTUAL<CRLF>
_____0. 0__g<CRLF>
_____+1000. 1__g<CRLF>
TARGET<CRLF>
_____+1000. 0__g<CRLF>
SIGNATURE<CRLF>
<CRLF>
<CRLF>
----- <CRLF>
<CRLF>
<CRLF>
    
```

□ : Space, ASCII 20h  
 CR: Carriage return, ASCII 0Dh  
 LF: Line feed, ASCII 0Dh

### Output of "Title block" and "End block"

When a weight value is recorded as the GLP report, "Title block" and "End block" are added at the beginning and at the end of a group of weight values.

#### Title block

1. Press and hold the **PRINT** key. Release the **PRINT** key when **StArT** is displayed. The balance outputs the "Title block".

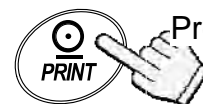
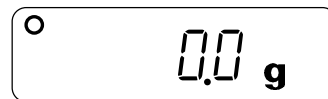

Press and hold

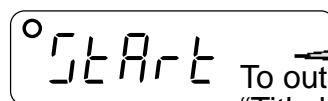

To output "Title block"

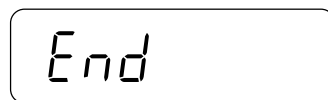

2. The balance can output the weight data by pressing the **PRINT** key or selecting the auto-print mode.

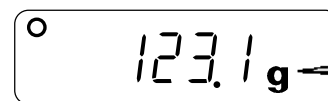

To output weight data

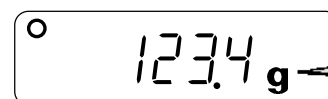

## End block

3. Press and hold the **PRINT** key. Release the **PRINT** key when `rEcEnd` is displayed. The balance outputs the "End block".



4. `End` appears. Press the **MODE** key to return to the weighing mode.



Returns to the weighing mode

AD-8121 format "info 1"

```

      A & D
MODEL  EK-1200i
S/N    01234567
ID     ABCDEF
DATE   2011/11/17
START
TIME   01:23:45

ST,+000123.4  g
ST,+000234.5  g
ST,+000345.6  g
ST,+000456.7  g

END
TIME   01:25:43
SIGNATURE
-----
  
```

Title block

Manufacturer

Model

ID number

Date

Start time

Weight data

Ending time

Column for signature

End block

General format "info 2"

```

.....A_&_D<CRLF>
MODEL_...EK-1200i<CRLF>
S/N.....Q1234567<CRLF>
ID.....ABCDEF<CRLF>
DATE<CRLF>
<CRLF>
START<CRLF>
TIME<CRLF>
<CRLF>
<CRLF>
ST,+000123.4...g<CRLF>
ST,+000234.5...g<CRLF>
ST,+000345.6...g<CRLF>
ST,+000456.7...g<CRLF>

END<CRLF>
TIME<CRLF>
<CRLF>
SIGNATURE<CRLF>
<CRLF>
<CRLF>
----- <CRLF>

<CRLF>
<CRLF>
  
```

□ : Space, ASCII 20h

CR: Carriage return, ASCII 0Dh

LF: Line feed, ASCII 0Ah

# 11. OPTIONS

The following options are available for the EK/EW-*i* series:

- OP-04 Comparator relay output and buzzer
- OP-07 Underhook assembly for the EK-6000*i*, EK-12K*i*, EK-4100*i*, EK-6100*i* and EW-12K*i*
- OP-09 Rechargeable battery pack (Ni-MH)
- OP-12 Carrying case

## 11-1. OP-04 Comparator relay output and buzzer

Allows output of the HI, OK or LO signal results to an external device as a solid state relay output.

It is possible to sound a buzzer according to the comparison result. See the function "bEP" to set which result will make a buzzer sound.

- The comparator function on/off, the comparison mode and comparator buzzer output can be selected using the function settings. See the settings "cP" and "bEP".**
- OP-04 cannot be used together with OP-09.**

### Output circuit

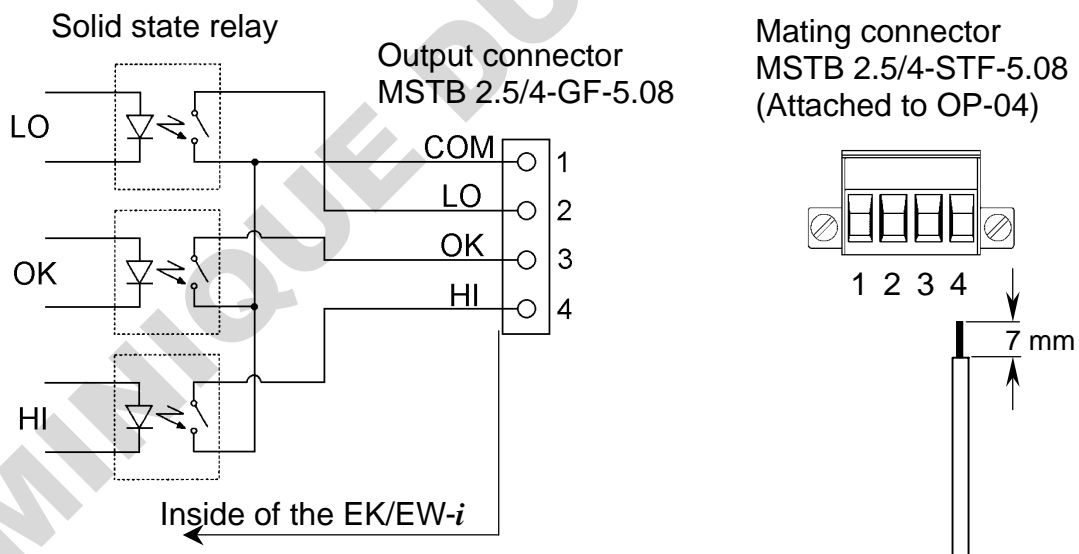

### Maximum rating

The maximum rating of the relay output is as follows.

- Maximum voltage: 50V DC
- Maximum current: 100mA DC
- Maximum ON resistance: 8Ω



## OP-04 Installation

1. Remove the cover of the option slot on the rear of balance by pressing and lowering it down.
2. Insert the option into the slot and secure it with the screws attached.

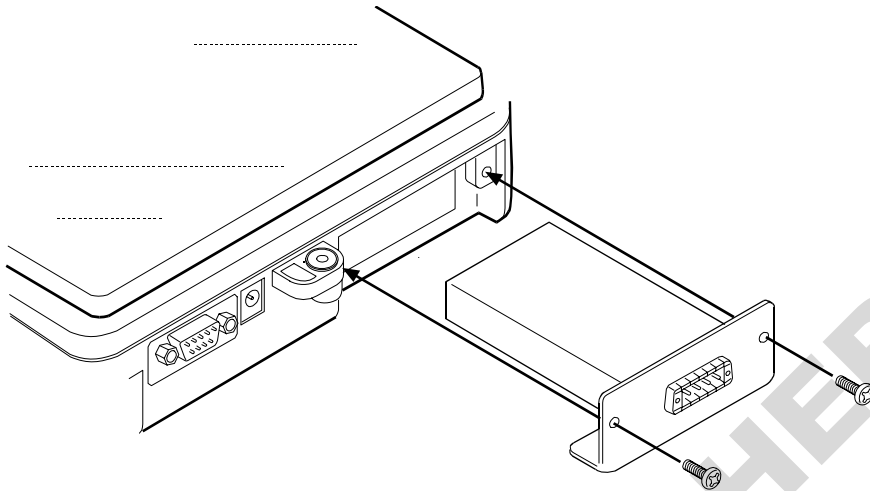

## 11-2. OP-07 Underhook assembly

By attaching the underhook assembly to the bottom of the balance, large objects that are difficult to load on the weighing pan can be weighed in suspension, and the specific gravity of objects may be measured.

- ❑ *OP-07 is available for use with the EK-6000i / 12Ki / 4100i / 6100i and EW-12Ki balances only.*
- ❑ *The calibration with a weight being hung on the hook is required for an accurate weighing.*

## OP-07 Installation

Remove the cover on the bottom of the balance, and screw the underhook assembly into the mounting hole.

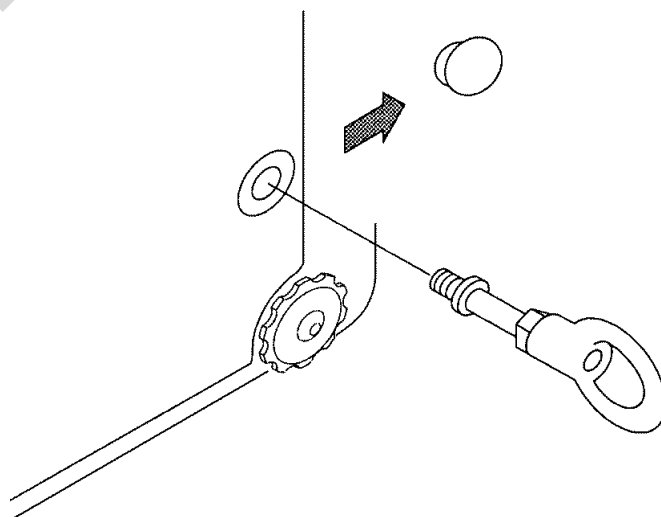

### 11-3. OP-09 Rechargeable battery pack (Ni-MH)

By installing the rechargeable battery pack (Ni-MH) into the balance, cordless operation can be carried out for approximately 9 hours (used with the LCD backlight off).

- ❑ OP-09 cannot be used together with OP-04.***
- ❑ The battery life will vary depending on how the balance is used, ambient temperature and so on.***

#### Charging the battery pack

Connect the AC adapter to the balance and turn the power off, then charging starts. It will take approximately 15 hours to reach full charge.

- ❑ If “Lb0” is displayed when using the battery pack, immediately stop using it, and recharge the battery pack or use the AC adapter.***
- ❑ Charge the battery pack at a temperature between 0°C (32°F) and 40°C (104°F).***
- ❑ Do not charge too long. Overcharging will reduce the life of the batteries.***
- ❑ Be sure to charge the battery pack when using for the first time or if it has not been used for a long time (more than one month). Recharging two or three times may be needed to reach full charge.***
- ❑ Be sure to use only the AC adapter that is provided with the EK/EW-i balance.***

#### OP-09 Installation

See the OP-04 installation.

### 11-4. OP-12 Carrying case

OP-12 is available for the convenience of carrying the balance by hand. However, note that because these balances are precision equipment, they will not be able to withstand excessive shock, such as being dropped.

---

# 12. MAINTENANCE

---

## 12-1. Notes on maintenance

- Do not disassemble the balance. Contact your local A&D dealer if your balance needs service or repair.
- Please use the original package for transportation.
- Do not use organic solvents to clean the balance. Use a lint free cloth dampened with a mild detergent.

## 12-2. Error codes

### Overload error

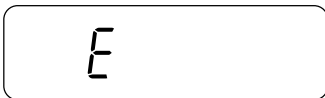

Warning to indicate that an object beyond the balance capacity has been placed on the pan. Remove the object from the pan.

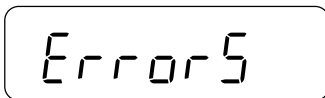

Warning to indicate that the balance detects an unexpected load. Remove all objects from the pan or check that the weighing pan is correctly installed.

### Range over notice

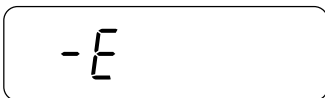

This will be shown if the weight sensor receives strong force upward. Check if there is anything sandwiched around the weighing pan. There is a possibility that the weight sensor itself may have a failure.

### Unit / 100% weight error

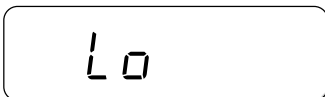

The unit / 100% weight is too light in the counting / % mode.

### Sample quantity notice

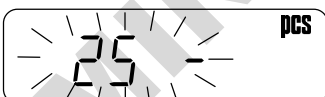
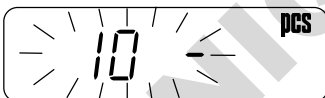

When sample weight is light and the counting error could become large, the balance will prompt you to use a larger number of samples. Place the displayed number of samples on the pan and press the **PRINT** key to store the unit weight.

**Note:** Pressing the **PRINT** key without adding samples may reduce counting accuracy.

Starting from the 100 samples, **100 -** may be displayed when the sample weight is light.

This is for your notice and press the **PRINT** key without adding any samples.

When "ACAI, 0" (ACAI disabled) or "Unit 2" is set, this notice is not shown.

### CAL errors

CAL E

Warning to indicate that calibration has been canceled because the calibration weight is too heavy.

-CAL E

Warning to indicate that calibration has been canceled because the calibration weight is too light.

Check the weighing pan and the calibration weight.  
To return to the weighing mode, press the **MODE** key.

### Low battery

Lb0

Warning to indicate that the battery pack (OP-09) is discharged. Immediately stop using it, and recharge or use the AC adapter.

### AC adapter error

Hb1

Warning to indicate that the output voltage of the AC adapter is too high. Check if the AC adapter is correct.

### Stability error

Error 1

Warning to indicate that the weight value is not stable and the balance cannot display it. Prevent vibration and drafts. Press the **MODE** key to return to the weighing mode.

### Internal errors (# = 2,3,4 or 5)

Error #

The balance detects error state in the internal processing. With nothing on the weighing pan, turn the power off and on again. If the error persists, request service.

**If you cannot cancel an error or other errors have occurred, request service from the store where you purchased the balance or from your local A&D dealer.**

# 13. SPECIFICATIONS

## 13-1. EK-*i* series

MODEL	EK-120 <i>i</i>	EK-200 <i>i</i>	EK-300 <i>i</i>	EK-600 <i>i</i>
Weight capacity	120 g	200 g	300 g	600 g
Min. display "d"	0.01 g	0.01 g	0.01 g	0.1 g
No. of samples	5, 10, 25, 50 or 100 pieces			
Max. count *)	12,000 pcs	20,000 pcs	30,000 pcs	6000 pcs
Min. unit weight *)	0.01 g	0.01 g	0.01 g	0.1 g
Min. % display	0.1 %			
Min. 100 % weight	1 g	1 g	1 g	10 g
Repeatability (Std. deviation)	0.01 g	0.01 g	0.01 g	0.1 g
Linearity	±0.01 g	±0.01 g	±0.02 g	±0.1 g
Sensitivity drift	±20 ppm / °C (10°C~30°C / 50°F~86°F)			
Display	7 segment LCD display with backlight (Character height 16 mm)			
Display update	10 time per second			
Operating temp.	-10°C~40°C / 14°F~104°F, less than 85% R.H. (non-condensing)			
Power supply	AC adapter or optional Ni-MH battery pack			
Battery operation	Approximately 9 hours (backlight off)			
Weighing pan size	110 mm ø			133mm x 170mm
Weight (approximately)	1.1 kg	1.1 kg	1.1 kg	1.3 kg
Calibration weight (factory setting)	120 g	200 g	300 g	600 g

MODEL	EK-1200 <i>i</i>	EK-2000 <i>i</i>	EK-3000 <i>i</i>	EK-6000 <i>i</i>	EK-12K <i>i</i>
Weight capacity	1200 g	2000 g	3000 g	6000 g	12 kg
Min. display "d"	0.1 g	0.1 g	0.1 g	1 g	1 g
No. of samples	5, 10, 25, 50 or 100 pieces				
Max. count *)	12,000 pcs	20,000 pcs	30,000 pcs	6000 pcs	12,000 pcs
Min. unit weight *)	0.1 g	0.1 g	0.1 g	1 g	1 g
Min. % display	0.1 %				
Min. 100 % weight	10 g	10 g	10 g	100 g	100 g
Repeatability (Std. deviation)	0.1 g	0.1 g	0.1 g	1 g	1 g
Linearity	±0.1 g	±0.1 g	±0.2 g	±1 g	±1 g
Sensitivity drift	±20 ppm / °C (10°C~30°C / 50°F~86°F)				
Display	7 segment LCD display with backlight (Character height 16 mm)				
Display update	10 time per second				
Operating temp.	-10°C~40°C / 14°F~104°F, less than 85% R.H. (non-condensing)				
Power supply	AC adapter or optional Ni-MH battery pack				
Battery operation	Approximately 9 hours (backlight off)				
Weighing pan size	133 mm x 170 mm				
Weight (approximately)	1.5 kg	1.5 kg	1.5 kg	1.5 kg	1.5 kg
Calibration weight (factory setting)	1200 g	2000 g	3000 g	6000 g	12 kg

\*) In case of "Min. unit weight" (factory setting)

MODEL	EK-410i	EK-610i	EK-4100i	EK-6100i
Weight capacity	400 g	600 g	4000 g	6000 g
Min. display "d"	0.01 g	0.01 g	0.1 g	0.1 g
No. of samples	5, 10, 25, 50 or 100 pieces			
Max. count *)	40,000 pcs	60,000 pcs	40,000 pcs	60,000 pcs
Min. unit weight *)	0.01 g	0.01 g	0.1 g	0.1 g
Min. % display	0.1 %			
Min. 100 % weight	1 g	1 g	10 g	10 g
Repeatability (Std. deviation)	0.01 g	0.01 g	0.1 g	0.1 g
Linearity	±0.02 g	±0.02 g	±0.2 g	±0.2 g
Sensitivity drift	±20 ppm / °C (10°C~30°C / 50°F~86°F)			
Display	7 segment LCD display with backlight (Character height 16 mm)			
Display update	10 time per second			
Operating temp.	-10°C~40°C / 14°F~104°F, less than 85% R.H. (non-condensing)			
Power supply	AC adapter or optional Ni-MH battery pack			
Battery operation	Approximately 9 hours (backlight off)			
Weighing pan size	110 mm ø		133mm x 170mm	
Weight (approximately)	1.1 kg	1.1 kg	1.5 kg	1.5 kg
Calibration weight (factory setting)	400 g	600 g	4000 g	6000 g

\*) In case of "0.01 g" (factory setting)

## 13-2. EW-i series

MODEL	EW-150i			EW-1500i			EW-12Ki		
Weight capacity	30 g	60 g	150 g	300 g	600 g	1500 g	3 kg	6 kg	12 kg
Min. display "d"	0.01g	0.02g	0.05g	0.1g	0.2g	0.5g	1g	2g	5g
No. of samples	5, 10, 25, 50 or 100 pieces								
Max. count *)	15,000 pcs			15,000 pcs			12,000 pcs		
Min. unit weight *)	0.01 g			0.1 g			1 g		
Min. % display	0.1 %								
Min. 100 % weight	1 g			10 g			100 g		
Repeatability (Std. deviation)	0.01g	0.02g	0.05g	0.1g	0.2g	0.5g	1g	2g	5g
Linearity	±0.01g	±0.02g	±0.05g	±0.1g	±0.2g	±0.5g	±1g	±2g	±5g
Sensitivity drift	±20 ppm / °C (10°C~30°C / 50°F~86°F)								
Display	7 segment LCD display with backlight (Character height 16 mm)								
Display update	10 time per second								
Operating temp.	-10°C~40°C / 14°F~104°F, less than 85% R.H. (non-condensing)								
Power supply	AC adapter or optional Ni-MH battery pack								
Battery operation	Approximately 9 hours (backlight off)								
Weighing pan size	110 mm ø			133 mm x 170 mm					
Weight (approximately)	1.1 kg			1.5 kg			1.5 kg		
Calibration weight (factory setting)	150 g			1500 g			12 kg		

\*) In case of "0.01 g" (factory setting)

### 13-3. Other weighing units

MODEL		EK-120i	EK-200i	EK-300i	EK-600i	EK-1200i	EK-2000i	EK-3000i	EK-6000i	EK-12Ki
oz.	Capacity	4.2330	7.0550	10.5820	21.165	42.330	70.550	105.820	211.65	423.30
	Min. display	0.0005	0.0005	0.0005	0.005	0.005	0.005	0.005	0.05	0.05
lb	Capacity	-----	-----	-----	1.3230	2.6455	4.4090	6.6140	13.230	26.455
	Min. display	-----	-----	-----	0.0005	0.0005	0.0005	0.0005	0.005	0.005
ozt	Capacity	3.8580	6.4300	9.6450	19.290	38.580	64.300	96.450	192.90	385.80
	Min. display	0.0005	0.0005	0.0005	0.005	0.005	0.005	0.005	0.05	0.05
ct	Capacity	600.00	1000.00	1500.00	3000.0	6000.0	10000.0	15000.0	-----	-----
	Min. display	0.05	0.05	0.05	0.5	0.5	0.5	0.5	-----	-----
mom	Capacity	32.000	53.335	80.000	160.00	320.00	533.35	800.00	1600.0	3200.0
	Min. display	0.005	0.005	0.005	0.05	0.05	0.05	0.05	0.5	0.5
dwt	Capacity	77.16	128.60	192.90	385.8	771.6	1286.0	1929.0	3858	7716
	Min. display	0.01	0.01	0.01	0.1	0.1	0.1	0.1	1	1
GN	Capacity	1851.8	3086.4	4629.8	9260	18518	30864	46298	-----	-----
	Min. display	0.2	0.2	0.2	2	2	2	2	-----	-----
tl	Capacity	3.1745	5.2910	7.9365	15.875	31.745	52.910	79.365	158.75	317.45
	Min. display	0.0005	0.0005	0.0005	0.005	0.005	0.005	0.005	0.05	0.05

MODEL		EK-410i	EK-610i	EK-4100i	EK-6000i
oz.	Capacity	14.110	21.164	141.10	211.64
	Min. display	0.001	0.001	0.01	0.01
lb	Capacity	0.8818	1.3228	8.818	13.228
	Min. display	0.0001	0.0001	0.001	0.001
ozt	Capacity	12.860	19.290	128.60	192.90
	Min. display	0.001	0.001	0.01	0.01
ct	Capacity	2000.0	3000.0	20000	30000
	Min. display	0.1	0.1	1	1
mom	Capacity	106.665	160.000	1066.65	1600.00
	Min. display	0.005	0.005	0.05	0.05
dwt	Capacity	257.21	385.81	2572.1	3858.1
	Min. display	0.01	0.01	0.1	0.1
GN	Capacity	6173.0	9259.4	61730	92594
	Min. display	0.2	0.2	2	2
tl	Capacity	10.5820	15.8735	105.820	158.735
	Min. display	0.0005	0.0005	0.005	0.005

MODEL		EW-150i			EW-1500i			EW-12Ki		
oz.	Capacity	1.0580	2.116	5.292	10.580	21.16	52.92	105.80	211.6	423.2
	Min. display	0.0005	0.001	0.002	0.005	0.01	0.02	0.05	0.1	0.2
lb	Capacity	-----	-----	-----	0.6615	1.323	3.306	6.615	13.23	26.46
	Min. display	-----	-----	-----	0.0005	0.001	0.002	0.005	0.01	0.02
ozt	Capacity	0.9645	1.929	4.822	9.645	19.29	48.22	96.45	192.9	385.8
	Min. display	0.0005	0.001	0.002	0.005	0.01	0.02	0.05	0.1	0.2
ct	Capacity	150.00	300.0	750.0	1500.0	3000	7500	-----	-----	-----
	Min. display	0.05	0.1	0.2	0.5	1	2	-----	-----	-----
mom	Capacity	8.000	16.00	40.00	80.00	160.0	400.0	800.0	1600	3200
	Min. display	0.005	0.01	0.02	0.05	0.1	0.2	0.5	1	2
dwt	Capacity	19.29	38.58	96.45	192.9	385.8	964.5	1929	3858	7715
	Min. display	0.01	0.02	0.05	0.1	0.2	0.5	1	2	5
GN	Capacity	463.0	926.0	2315	4630	9260	23150	-----	-----	-----
	Min. display	0.2	0.5	1	2	5	10	-----	-----	-----
tl	Capacity	0.7935	1.587	3.968	7.935	15.87	39.68	79.35	158.7	317.4
	Min. display	0.0005	0.001	0.002	0.005	0.01	0.02	0.05	0.1	0.2

**Note**

*The unit "tl (Hong Kong General / Singapore)" is for special versions only.*

## 13-4. Dimensions

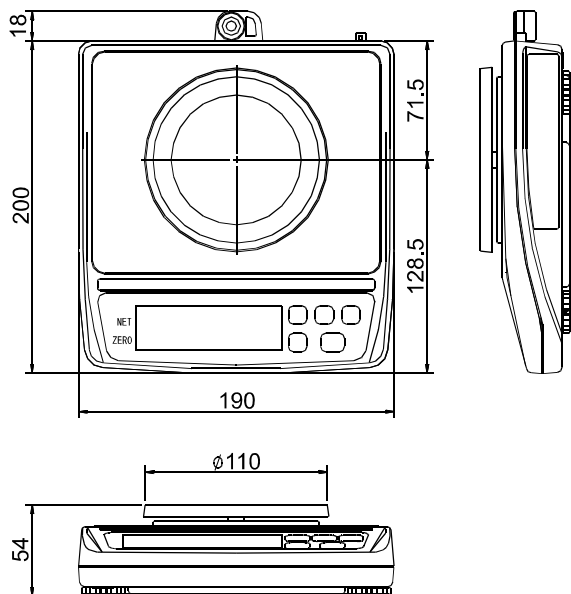

EK-120*i* / EK-200*i* / EK-300*i*

EK-410*i* / EK-610*i*

EW-150*i*

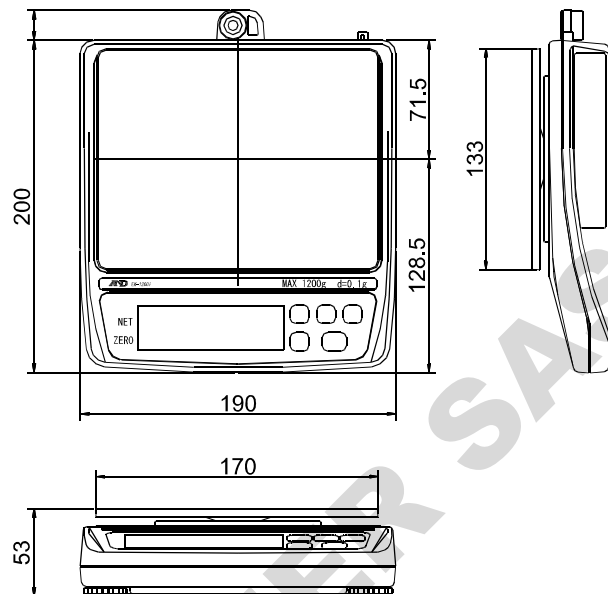

EK-600*i* / EK-1200*i* / EK-2000*i*

EK-3000*i* / EK-6000*i* / EK-12K*i*

EK-4100*i* / EK-6100*i*

EW-1500*i* / EW-12K*i*



# GRAVITY ACCELERATION MAP

## Values of gravity at various locations

Amsterdam	9.813 m/s <sup>2</sup>	Manila	9.784 m/s <sup>2</sup>
Athens	9.800 m/s <sup>2</sup>	Melbourne	9.800 m/s <sup>2</sup>
Auckland NZ	9.799 m/s <sup>2</sup>	Mexico City	9.786 m/s <sup>2</sup>
Bangkok	9.783 m/s <sup>2</sup>	Milan	9.807 m/s <sup>2</sup>
Birmingham	9.813 m/s <sup>2</sup>	Moscow	9.816 m/s <sup>2</sup>
Brussels	9.811 m/s <sup>2</sup>	New York	9.802 m/s <sup>2</sup>
Buenos Aires	9.797 m/s <sup>2</sup>	Oslo	9.819 m/s <sup>2</sup>
Cape Town	9.796 m/s <sup>2</sup>	Ottawa	9.807 m/s <sup>2</sup>
Chicago	9.803 m/s <sup>2</sup>	Paris	9.810 m/s <sup>2</sup>
Copenhagen	9.816 m/s <sup>2</sup>	Rio de Janeiro	9.788 m/s <sup>2</sup>
Cyprus	9.797 m/s <sup>2</sup>	Rome	9.803 m/s <sup>2</sup>
Frankfurt	9.811 m/s <sup>2</sup>	San Francisco	9.800 m/s <sup>2</sup>
Glasgow	9.816 m/s <sup>2</sup>	Singapore	9.780 m/s <sup>2</sup>
Havana	9.788 m/s <sup>2</sup>	Stockholm	9.819 m/s <sup>2</sup>
Helsinki	9.819 m/s <sup>2</sup>	Sydney	9.796 m/s <sup>2</sup>
Jakarta	9.781 m/s <sup>2</sup>	Taichung	9.789 m/s <sup>2</sup>
Kolkata (Calcutta)	9.788 m/s <sup>2</sup>	Taipei	9.790 m/s <sup>2</sup>
Kuwait	9.793 m/s <sup>2</sup>	Tokyo	9.798 m/s <sup>2</sup>
Lisbon	9.801 m/s <sup>2</sup>	Vancouver, BC	9.810 m/s <sup>2</sup>
London (Greenwich)	9.812 m/s <sup>2</sup>	Washington DC	9.801 m/s <sup>2</sup>
Los Angeles	9.797 m/s <sup>2</sup>	Wellington NZ	9.803 m/s <sup>2</sup>
Madrid	9.802 m/s <sup>2</sup>	Zurich	9.808 m/s <sup>2</sup>

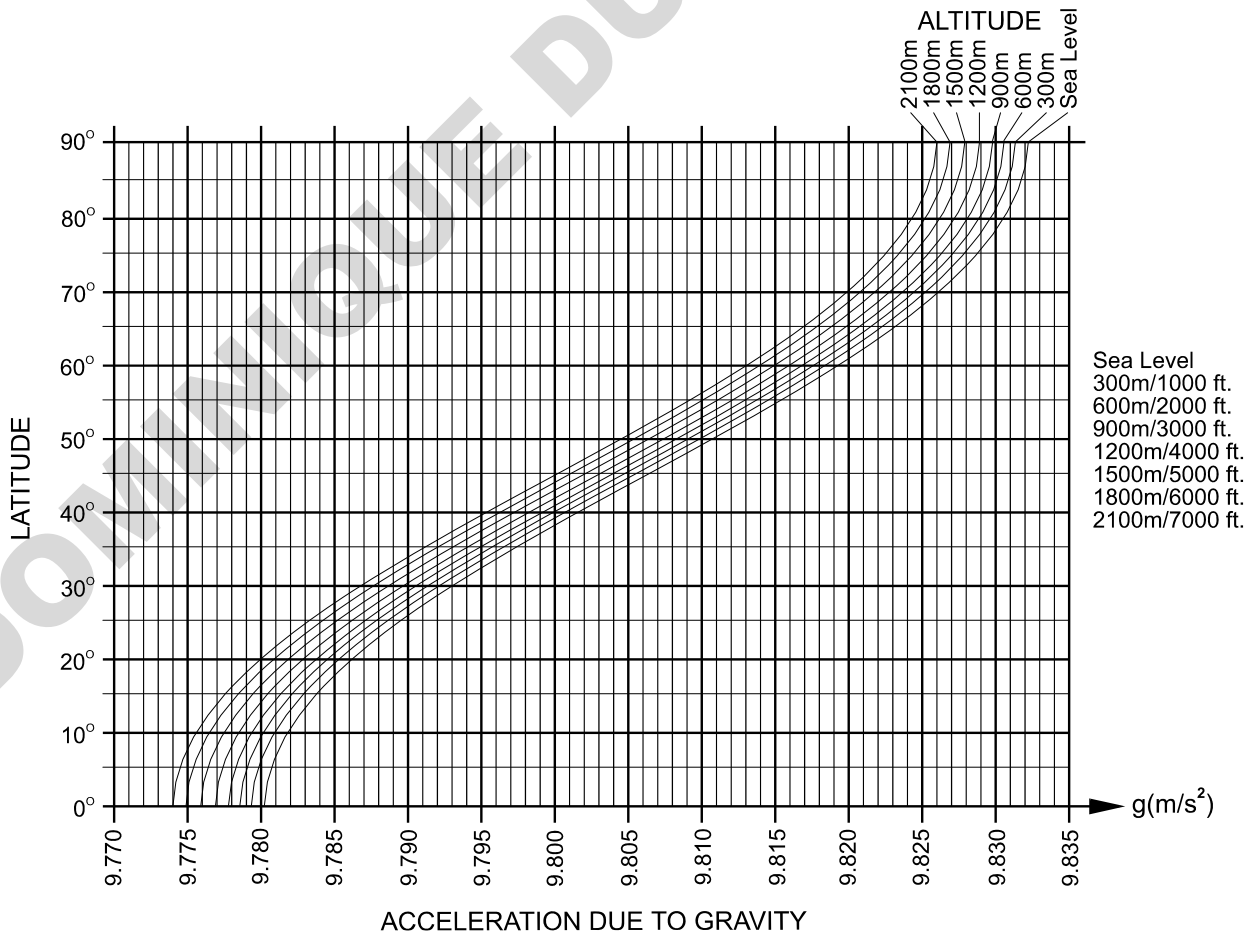

# World map

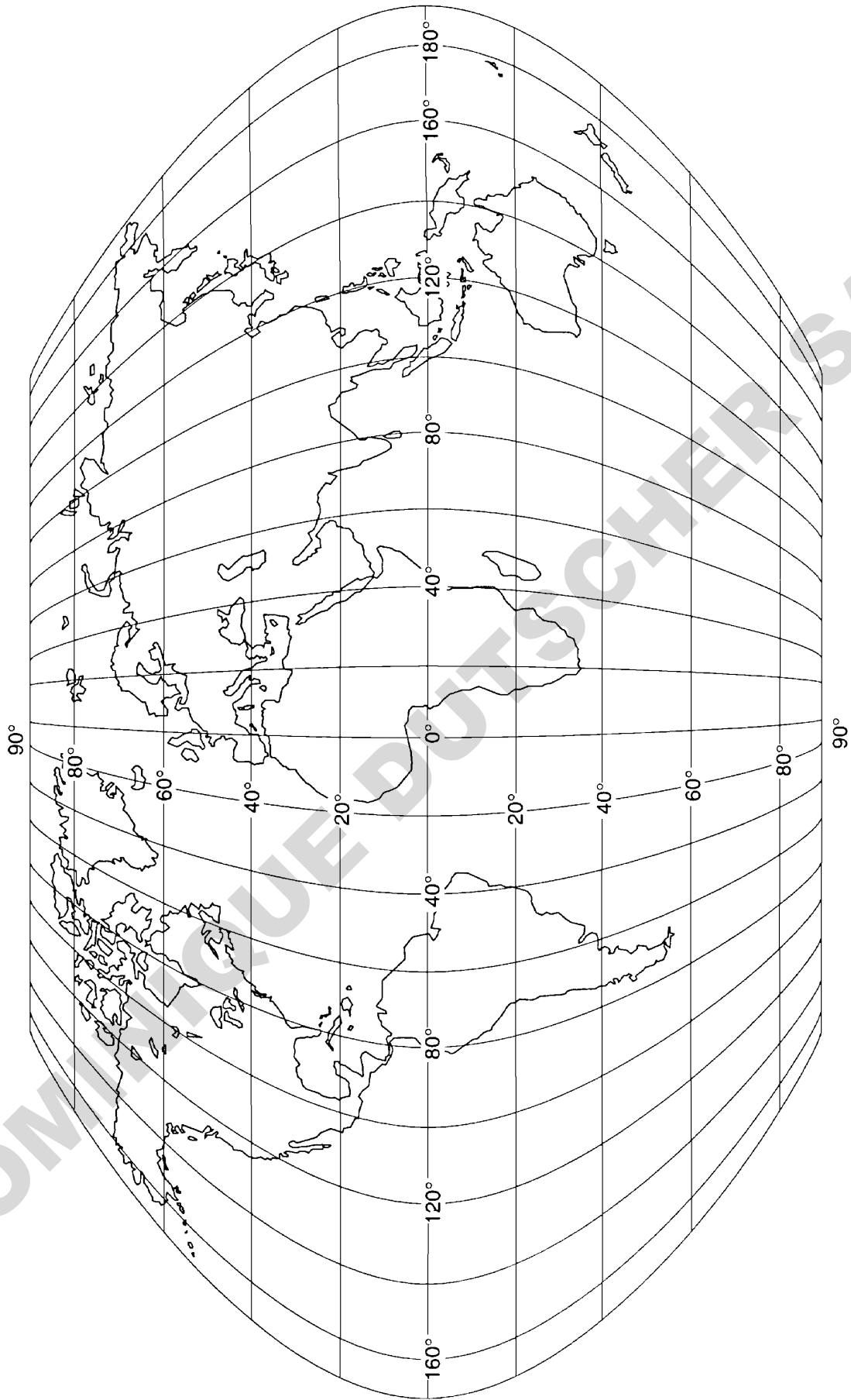



### **A&D Company, Limited**

3-23-14 Higashi-Ikebukuro, Toshima-ku, Tokyo 170-0013 JAPAN  
Telephone: [81] (3) 5391-6132 Fax: [81] (3) 5391-6148

### **A&D ENGINEERING, INC.**

1756 Automation Parkway, San Jose, California 95131 U.S.A.  
Telephone: [1] (408) 263-5333 Fax: [1] (408)263-0119

### **A&D INSTRUMENTS LIMITED <UK Office>**

Unit 24/26 Blacklands Way, Abingdon Business Park, Abingdon, Oxfordshire OX14 1DY United Kingdom  
Telephone: [44] (1235) 550420 Fax: [44] (1235) 550485

### **A&D INSTRUMENTS LIMITED <German Sales Office>**

Große Straße 13 b 22926 Ahrensburg Deutschland  
Telefon: [49] (0) 4102 459230 Telefax: [49] (0) 4102 459231

### **A&D Australasia Pty Ltd.**

32 Dew Street, Thebarton, South Australia 5031 AUSTRALIA  
Telephone: [61] (8) 8301-8100 Fax: [61] (8) 8352-7409

### **A&D KOREA Limited**

한국에이.엔.디(주)  
대한민국 서울시 영등포구 여의도동 36-2 맨하탄 빌딩 8층  
( 8th Floor, Manhattan Bldg. 36-2 Yoido-dong, Youngdeungpo-ku, Seoul, KOREA )  
전화: [82] (2) 780-4101 팩스: [82] (2) 782-4280

### **A&D RUS CO., LTD.**

Компания Эй энд Ди Рус  
121357, Российская Федерация, г.Москва, ул. Вереysкая, дом 17  
( Bldg. 17, Vereyskaya st., Moscow, 121357 RUSSIAN FEDERATION )  
тел.: [7] (495) 937-33-44 факс: [7] (495) 937-55-66

### **A&D Instruments India Private Limited**

ऐ&डी इन्स्ट्रुमेन्ट्स इण्डिया प्रा० लिमिटेड  
509, उद्योग विहार , फेस -5, गुडगांव - 122016, हरियाणा , भारत  
( 509, Udyog Vihar, Phase-V, Gurgaon - 122 016, Haryana, India )  
फोन : 91-124-4715555 फैक्स : 91-124-4715599