

**GX-M SERIES**

**GF-M SERIES**

**Multi-Function Balance**

## INSTRUCTION MANUAL

### **G X - M series**

GX-8202M / GX-8202MD / GX-10202M / GX-12001M  
GX-22001M / GX-32001M / GX-32001MD

### **G F - M series**

GF-8202M / GF-8202MD / GF-10202M / GF-12001M  
GF-22001M / GF-32001M / GF-32001MD

**AND**

A&D Company, Ltd.

1WMPD4003846

© 2020 A&D Company Ltd. All rights reserved.

No part of this publication may be reproduced, transmitted, transcribed, or translated into any language in any form by any means without the written permission of A&D Company Ltd.

The contents of this manual and the specifications of the instrument covered by this manual are subject to change for improvement without notice.

Windows, Word and Excel are registered trademarks of the Microsoft Corporation.

DOMINIQUE DUTSCHER SAS

# Contents

1. Introduction .....	6
1-1 Features .....	6
1-2 About The Models .....	7
1-3 Compliance .....	7
1-4 About Communication Manual .....	8
2. Unpacking The Balance .....	9
2-1 Installing The Balance .....	10
3. Precautions .....	11
3-1 Before Use.....	11
3-2 During Use.....	12
3-3 After Use.....	12
3-4 Power Supply .....	13
4. Display Symbols And Key Operation .....	14
4-1 Smart Range Function .....	16
5. Weighing Units.....	17
5-1 Units .....	17
5-2 Storing Units .....	22
6. Weighing.....	24
6-1 Basic Operation .....	24
6-2 Counting Mode (PCS) .....	26
6-3 Percent Mode (%) .....	28
6-4 Animal Weighing Mode (Hold Function) .....	29
7. Impact Detection Function .....	30
7-1 Recording Impact History.....	31
7-2 Output Impact History.....	31
8. Response Adjustment / Self Check Function.....	33
8-1 Response Adjustment .....	33
8-2 Self-Check-Function / Automatic Setting Of Minimum Weight Value.....	34
9. Calibration.....	36
9-1 Automatic Self Calibration For The GX-M Series.....	37
9-2 One-Touch Calibration For The GX-M Series .....	38
9-3 Calibration Using An External Weight .....	39
9-4 Calibration Test Using An External Weight.....	40
9-5 How to set the External Weight Value.....	41
9-6 Correcting The Internal Mass Value Of The GX-M series.....	42
9-7 Correcting The Internal Mass Value Of The GX-M series (Auto).....	43
10. Function Switch And Initialization.....	44
10-1 Permit Or Inhibit .....	44

10-2 Initializing The Balance.....	46
<b>11. Function Table .....</b>	<b>47</b>
11-1 Setting The Function Table .....	47
11-2 Details Of The Function Table .....	49
11-3 Description Of The Class "Environment, Display" .....	56
11-4 Description Of The Data Output .....	57
11-5 Description Of The Data Format.....	57
11-6 Output Example Of The Data Format.....	57
11-7 Clock And Calendar Function .....	58
11-8 Comparator Function .....	60
11-9 Adding the Comparison Results .....	66
11-10 Main Display Comparison Function.....	67
11-11 Description Of Application.....	68
11-12 Outputting the function setting information .....	69
<b>12. ID Number And GLP Report .....</b>	<b>72</b>
12-1 Main Objective.....	72
12-2 Setting The ID Number.....	72
12-3 GLP Report.....	74
<b>13. Data Memory .....</b>	<b>78</b>
13-1 Data Memory For Weighing Data .....	78
13-2 Data Memory For Calibration And Calibration Test.....	82
13-3 Data Memory for Unit Mass in the Counting Mode .....	85
13-4 Data Memory for Comparator Settings.....	88
13-5 Data Memory for Tare Value.....	91
13-6 Data Memory: Quick Selection Mode.....	94
13-7 Data Memory: Confirmation and Storage Mode.....	95
<b>14. Statistical Calculation Mode.....</b>	<b>97</b>
14-1 How To Use The Statistical Calculation.....	97
14-2 Statistical Calculation Mode (Example Of Use).....	102
<b>15. Flow Measurement .....</b>	<b>104</b>
15-1 How To Use Flow Measurement .....	104
<b>16. Gross Net Tare Function.....</b>	<b>108</b>
16-1 Preparation Of Gross Net Tare Function .....	108
16-2 Example Of Using The Gross Net Tare Function .....	110
<b>17. Minimum Weighing Warning Function .....</b>	<b>111</b>
17-1 Comparing the minimum weighing value .....	111
17-2 Entering and outputting the minimum weighing value.....	112
<b>18. Underhook.....</b>	<b>117</b>
<b>19. Programmable-Unit .....</b>	<b>118</b>
<b>20. Density Measurement.....</b>	<b>119</b>

21. Password Lock Function.....	124
21-1 Enable Password Lock Function.....	125
21-2 How To Input The Password At The Start Of Weighing.....	126
21-3 How To Logout.....	127
21-4 Registering Password (Changing) .....	128
21-5 Changing Password .....	129
21-6 How To Delete The Password (USER 01~10) .....	130
21-7 Missing Password .....	130
22. Repeatability Check Function (GX-M series only) .....	131
23. Interface Specification (Standard) .....	132
24. Maintenance .....	132
24-1 Treatment Of The Balance .....	132
25. Troubleshooting .....	133
25-1 Checking The Balance Performance And Environment.....	133
25-2 Error Codes .....	134
25-3 Other Display.....	137
25-4 Asking For Repair.....	137
26. Connection With Periphecal Device.....	138
26-1 Command.....	138
26-2 Key Lock Function.....	138
27. How To Check The Software Version Of The Balance .....	138
28. Specifications.....	139
29. External Dimention.....	141
29-1 Options And Peripheral Instruments .....	142

# 1. Introduction

This manual describes how the GX-M/GF-M series balance works and how to get the most out of it in terms of performance. Read this manual thoroughly before using the balance and keep it at hand for future reference.

Depending on the software version of your balance, there are cases that behave differently.

For confirmation of the software version of the balance, refer to "27. How To Check The Software Version Of The Balance".

## 1-1 Features

- The balance has a self-check function that inspects the balance itself using electronically controlled load (ECL) and evaluates performance. Read this manual thoroughly before using the balance and keep it at hand for future reference.
  - The balance can detect impact applied to its mass sensor and display the level of that impact. ISD (Impact Shock Detection).
  - Continuous change of the balance can be calculated as flow rate, displayed and output. FRD :( Flow Rate Display).
  - The balance is equipped with a data memory function, which can record weighing value, calibration result, and multiple unit mass (mass per sample in counting mode) (Up to 200 items are stored for weighing value).
  - The GX-M series has automatic self calibration using the internal mass, adapting to temperature changes, setting time and interval time.
  - Good laboratory practice (GLP) / Good manufacturing practice (GMP) data can be output using the RS-232C serial interface.
  - A built-in clock and calendar that can add the time and date to the output data. (Setting changes due to the clock can be limited only for an administrator. (Password Lock Function))
  - Comparator Indicators, displaying the comparison results with    . (Depending on the setting, 5-step comparison is also possible.)
  - Capacity Indicator, displaying the weight value in percentage relative to the weighing capacity.
  - Hold Function, provided for weighing a moving object such as an animal.
  - Underhook, for measuring density and weighing magnetic materials.
  - Password lock function can limit users for the balance to be used or changes due to the function settings by setting a password.
  - Key lock function allows the balance to only operate using commands from an external equipment by disabling key operations on the balance.
  - The balance is equipped with an RS-232C serial interface and a USB interface to communicate with a computer. Windows computer using the Windows communication tools software (WinCT) make building a system very easy. The latest Win-CT software can be downloaded from the A&D website.
- Windows is the registered trademark of the Microsoft Corporation.
- A breeze break is included with the model featuring a minimum display of 0.01g.

## 1-2 About The Models

There are many models in the GX-M series and GF-M series with differences in the models being the minimum display and weighing capacity. In this manual, they are listed collectively by the minimum display as shown in the table below.

Model	Minimum display	Applicable model	
		Internal mass type	General type
0.01g model	0.01g	GX-8202M / GX-8202MD GX-10202M	GF-8202M / GF-8202MD GF-10202M
0.1g model	0.1g	GX-12001M / GX-22001M GX-32001M / GX-32001MD	GF-12001M / GF-22001M GF-32001M / GF-32001MD

- For the GX-M series, a weight for sensitivity adjustment is built in. It is possible to use functions such as calibration and auto calibration using the internal mass.
- For the GF-M series, sensitivity adjustment weights are not built-in. When calibrating, it is necessary to prepare an external weight.

## 1-3 Compliance

### Compliance with FCC Rules

Please note that this equipment generates, uses and can radiate radio frequency energy. This equipment has been tested and has been found to comply with the limits of a Class A computing device pursuant to Subpart J of Part 15 of FCC rules. These rules are designed to provide reasonable protection against interference when equipment is operated in a commercial environment. If this unit is operated in a residential area, it may cause some interference and under these circumstances the user would be required to take, at his own expense, whatever measures are necessary to eliminate the interference.

(FCC = Federal Communications Commission in the U.S.A.)

## 1-4 About Communication Manual

About the contents of the communication, download "Communication manual" from our website (<https://www.aandd.jp/>) and refer to it.

DOMINIQUE DUTSCHER SAS



## 2. Unpacking The Balance

The balance is a precision instrument.

Unpack the balance carefully. Keep the packing material to be used for transporting the balance in the future.

- The packing contents depend on the balance model. See the illustrations to confirm that everything is contained.

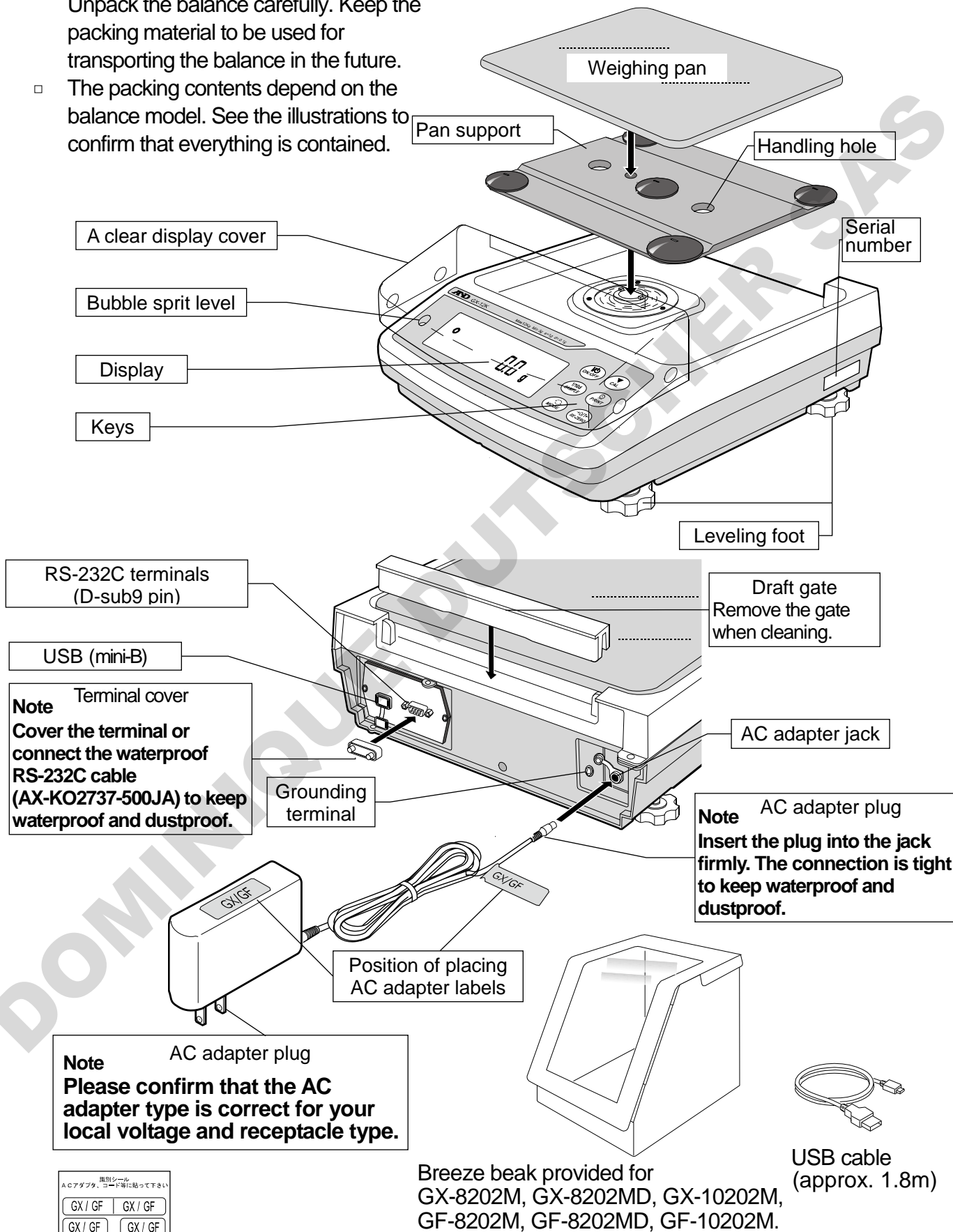

AC adapter labels

## 2-1 Installing The Balance

Install the balance as follows:

- 1 Refer to "**3. Precautions**" for installing the balance.
- 2 Install the pan support, weighing pan and draft gate. Refer to the previous page.
- 3 Adjust the leveling feet to level the balance. Confirm it using the bubble spirit level.
- 4 Confirm that the AC adapter type is correct for the local voltage and power receptacle type.
- 5 Connect the AC adapter to the balance firmly. Earth the balance. Warm up the balance for at least 30 minutes with nothing on the weighing pan.

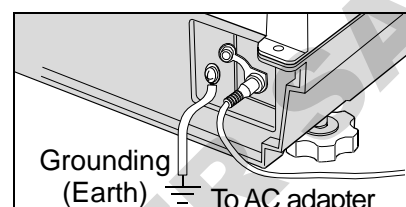
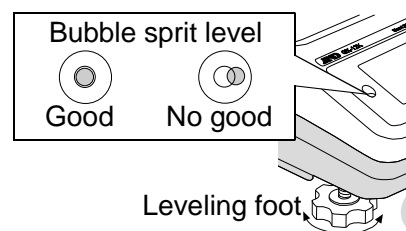

## 3.Precautions

To get the optimum performance from the balance and acquire accurate weighing data, note the following:

### 3-1 Before Use

- The maximum resolution of the precision balance is one million counts. Therefore, there are tendencies to be influenced by temperature change, air pressure change, vibration and drafts where the balance is placed.
- Install the balance in an environment where the temperature and humidity are not excessive. The best operating temperature is about 20°C / 68°F at about 50% relative humidity.
- Install the balance where it is not exposed to direct sunlight and it is not affected by heaters or air conditioners.
- Install the balance where it is free of dust.
- Install the balance away from equipment that produces magnetic fields.
- Install the balance in a stable place avoiding vibration and shock. Corners of rooms on the first floor are best, as they are less prone to vibration.
- The weighing table should be solid and free from vibration, drafts and as level as possible.
- Level the balance by adjusting the leveling feet and confirm it using the bubble spirit level.
- Ensure a stable power source when using the AC adapter.
- Connect the AC adapter and warm up the balance for at least 30 minutes.
- Calibrate the balance periodically for accurate weighing.
- When the balance is installed for the first time or has been moved, warm up the balance for at least 6 hours to allow the balance to reach equilibrium with the ambient temperature, and then perform calibration before use.
- The meaning of IP-65 is "No ingress of dust. Projected against water jets".  
If a powerful water jet is used or the balance is immersed in water, it may cause a damage that is due to ingress of water.
- Confirm that "the plug is inserted firmly into the jack" and "the terminal is covered using the waterproof cover or the waterproof RS-232C cable (AX-KO2737-500JA)", when using the balance.
- Use the waterproof option cable AX-KO2737-500JA, when the RS-232C interface is used with IP-65.  
AX-KO2466-200, a standard RS-232C cable, is not waterproof or dustproof.
- Confirm that the weighing pan does not touch to rim.

 **Do not install the balance where flammable or corrosive gas is present.**

## 3-2 During Use

- Discharge static electricity from the weighing material. When weighing sample (plastics, insulator, etc.) could have a static charge, the weighing value is influenced. Ground the balance, and
  - Eliminate the static electricity by AD-1683 as an accessory.
  - Or try to keep the ambient humidity above 45%RH at the room.
  - Or use the metal shield case.
  - Or wipe a charged material (plastic sample etc.) with the wet cloth.
- This balance uses a strong magnet as part of the balance assembly, so please use caution when weighing magnetic materials such as iron. If there is a problem, use the underhook on the bottom of the balance to suspend the material away from the influence of the magnet.
- Eliminate any temperature difference between the sample and the environment. When a sample is warmer (cooler) than the ambient temperature, the sample will be lighter (heavier) than the true weight. This error is due to a rising (falling) draft around the sample.
- Make each weighing gently and quickly to avoid errors due to changes in the environmental conditions.
- Do not drop things upon the weighing pan, or place a sample on the pan that is beyond the balance weighing capacity. Place the sample in the center of the weighing pan.
- Do not use a sharp instrument such as a pencil to press the keys. Use your finger only.
- Press the **RE-ZERO** key before each weighing to prevent possible errors.
- Calibrate the balance periodically so as to eliminate possible errors.
- Take into consideration the affect of air buoyancy on a sample when more accuracy is required.
- Prevent foreign matter, such as powder, liquid and metal, from invading the area around the weighing pan.
- Use the "breeze break" for a precision weighing.

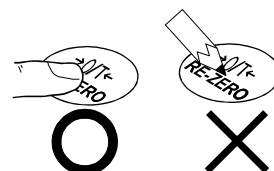
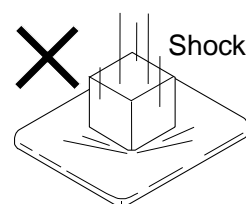
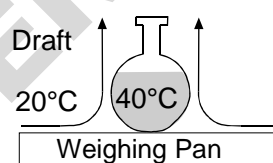
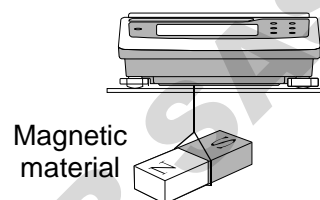
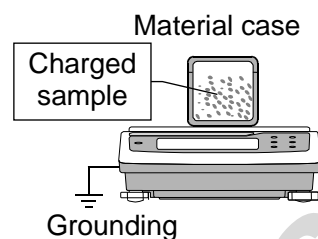

## 3-3 After Use

- Avoid mechanical shock to the balance.
- Do not disassemble the balance. Contact the local A&D dealer if the balance needs service or repair.
- Do not use organic solvents to clean the balance. Clean the balance with a lint free cloth that is moistened with warm water and a mild detergent.

- Do not allow the balance to be immersed in water. Even though the balance complies with IP code, the balance will not withstand being completely immersed in water.
- The weighing pan, pan support and draft gate can be removed to clean the balance. Clean by splashing with water.

### 3-4 Power Supply

- Do not remove the AC adapter while the internal mass is in motion, for example, right after the AC adapter is connected, or during calibration using the internal mass. If the AC adapter is removed under the conditions described above, the internal mass will be left unsecured, that may cause mechanical damage when the balance is moved.  
Before removing the AC adapter, press the  ON:OFF key and confirm that zero is displayed.
- When the AC adapter is connected, the balance is in the standby mode if the standby indicator is on. This is a normal state and does not harm the balance. For accurate weighing, keep the AC adapter connected to the balance and AC power unless the balance is not to be used for a long period of time.

# 4. Display Symbols And Key Operation

## Display symbols

- Number of statistical data (Statistical calculation mode)
- Displays the weight data relative to the weighing capacity, in percentage, in the weighing mode (**Capacity indicator**)

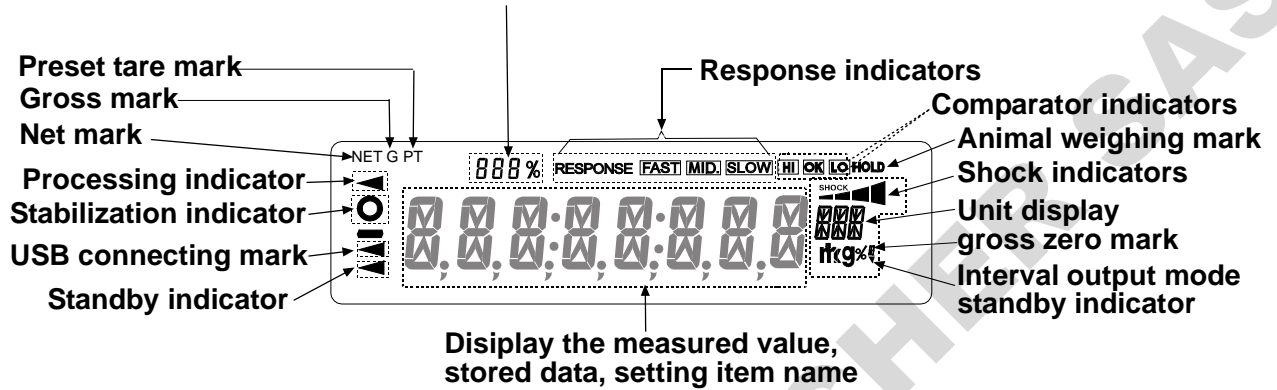

## Blinking display contents

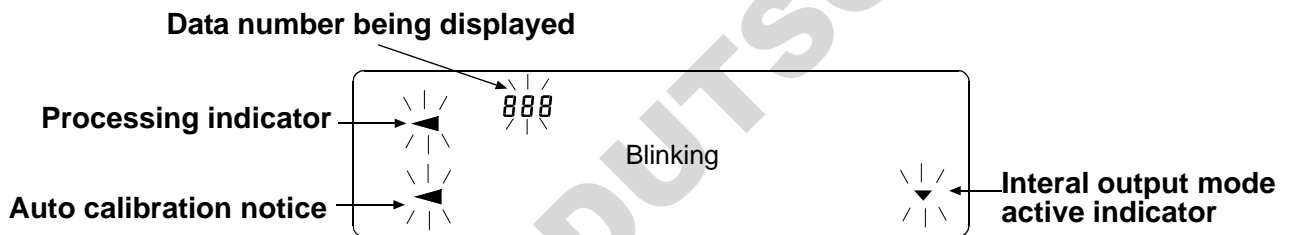

## Key operation

Key operation affects how the balance functions. The basic key operations are:





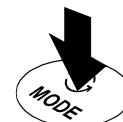

- “Press and release the key immediately” or “Press the key”  
= normal key operation during measurement
- “Press and hold the key”



Press the key.  
(Press and release the key immediately.)



Press and hold the key.  
(for 2 seconds)

Key	When pressed	When pressed and held (for 2 seconds)
	Turns the display <b>ON:OFF</b> . The standby indicator is displayed when the display is turned off. The weighing mode is enabled when the display is turned on.  When password function is enable, password input display will be displayed. Refer to "21-2 How to Input The Password At The Start Of Weighing"  This <b>ON:OFF</b> key is available anytime. Pressing the <b>ON:OFF</b> key during operation will interrupt operation and turn the display OFF. *	
	In the weighing mode, turns the minimum weighing value on and off. In the counting or percent mode, enters the sample storing mode.	<ul style="list-style-type: none"> <li>• Enters the function table mode. Please refer to "11.Function Table".</li> <li>• Run the repeatability check function. Please refer to "22.Repeatability Check Function". (GX-M series only)</li> </ul>
	Switches the weighing units stored in the function table. Refer to "5. Weighing".	Enters mode of the Self-Check Function.
	Performs calibration of the balance using the internal mass. (GX-M series only)	Displays other items of the calibration menu.
	Stores the weighing data in memory or outputs to a printer or personal computer depending on the function table settings. (Factory setting = output)	Enters mode to change the unit mass registration number in counting mode. By changing the function table: <ul style="list-style-type: none"> <li>• Outputs "Title block" and "End block" for GLP,GMP report.</li> <li>• Displays the data memory menu.</li> <li>• Enters mode for reading density number in flow measurement.</li> </ul>
	Sets the display to zero.	

\*When the "Gross net tare function" is selected, the display is turned off by pressing and holding (for 2 seconds).

Please refer to "16.Gross Net Tare Function".

## 4-1 Smart Range Function

- The GX-8202MD, GF-8202MD, GX-32001MD and GF-32001MD are equipped with two ranges of "precision range" of a higher resolution and "standard range" of normal resolution.
- The range is switched automatically depending on the value displayed.  
Placing a heavy container on the weighing pan and pressing the **RE-ZERO** key allows the balance to weigh in the precision range. (Smart range function)
- The range can be fixed to the standard range, by pressing the **SAMPLE** key.

### Note

- Once the range is switched to the standard range, it will not switch to the precision range automatically even when the displayed value becomes within the precision range value. Press the **RE-ZERO** or **SAMPLE** key to use the precision range again.

### Example

GX-32001MD and GF-32001MD, precision range = 6.2 kg x 0.1g,  
standard range = 32.2 kg x 1 g.

- Step 1 Press the **RE-ZERO** key.  
The balance will start weighing, using the precision range.
- Step 2 Place a container on the weighing pan.  
When the weighing value exceeds the precision range, the range will be switched to the standard range.
- Step 3 Press the **RE-ZERO** key.  
The balance will be switched to the precision range.
- Step 4 Place a sample on the pan.  
When the weighing value is within the precision range, the balance will perform a weighing using the precision range.

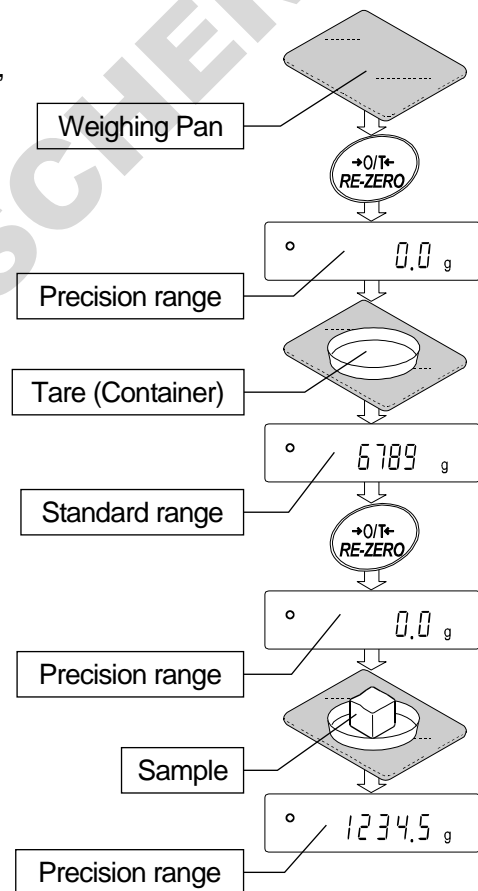

### Precision range/standard range value

		Precision range (after <b>RE-ZERO</b> key is pressed)	Standard range
GX-32001MD	g	Up to 6200.9 g	6201 g to 32208 g
GF-32001MD	g	Up to 6200.9 g	6201 g to 32208 g
GX-8202MD	g	Up to 2200.09 g	2200.1 g to 8200.8 g
GF-8202MD	g	Up to 2200.09 g	2200.1 g to 8200.8 g



# 5. Weighing Units

## 5-1 Units

With the GX-M /GF-M series balance, the following weighing units and weighing modes are available :

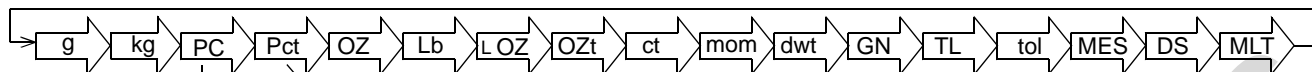

Counting mode

Percent mode

Density mode (To use this mode, it must be stored in the function table as described on page 47. For details about this mode, refer to "20. Density Measurement". To select this mode, press the **MODE** key until the processing indicator blinks with the unit "g" displayed. "DS" appears only when the density value is displayed.)

Programmable-unit (No unit displayed. For details, refer to "19. Programmable-Unit".)

A unit or mode can be selected and stored in the function table as described on page 47.

If a weighing mode (or unit of weight) has been turned off, that mode or unit will be missing in the sequence. Tael has four varieties, one of which can be selected and installed at the factory.

To select a unit or mode for weighing, press the **MODE** key.

For details about the units and modes, see the table below:

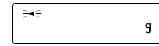
Name (unit, mode)	Abbrev.	Display	Function table (Storing mode)	Conversion factor 1 g =
Gram	g	g	g	1 g
kilogram	kg	<b>kg</b>	<b>kg</b>	1000 g
Counting mode	PCS	<i>PCS</i>	<i>PCS</i>	—
Percent mode	%	%	%	—
Ounce (Avoir)	OZ	<i>OZ</i>	<i>OZ</i>	28.349523125 g
Pound	Lb	<i>Lb</i>	<i>Lb</i>	453.59237 g
Pound/Ounce	L OZ	<i>L OZ</i>	<i>LO</i>	1Lb=16 oz, 1 oz=28.349523125 g
Troy Ounce	OZt	<i>OZt</i>	<i>OZt</i>	31.1034768 g
Metric Carat	ct	<i>ct</i>	<i>ct</i>	0.2 g
Momme	mom	<b>mom</b>	<b>mom</b>	3.75 g
Pennyweight	dwt	<i>dwt</i>	<i>dwt</i>	1.55517384 g
Grain (UK)	GN	<i>GN</i>	<i>GN</i>	0.06479891 g
Tael (HK general, Singapore)	TL	<i>TL</i>	<i>TL</i>	37.7994 g
Tael (HK jewelry)				37.429 g
Tael (Taiwan)				37.5 g
Tael (China)				31.25 g
Tola (India)	tol	<i>tol</i>	<i>tol</i>	11.6638038 g
Messghal	MES	<i>MES</i>	<i>MES</i>	4.6875 g
Density mode (See note below)	DS	 DS is used to show the density.	<i>DS</i>	—
Programmable-unit (Multi-unit)	MLT	<i>MLt</i>	<i>MLt</i>	—

**Note: The blinking processing indicator with “g” indicates that the density mode is selected.**

The tables below indicate the weighing capacity and the minimum display for each unit, depending on the balance model.

GX/GF-M		GX-8202M GF-8202M	GX-10202M GF-10202M	
Unit		Capacity	Capacity	minimum display
Gram	g	8200	10200	0.01
Kiloram	kg	8.20	10.2	0.00001
Once(Avoir)	oz	289	360	0.0005
Pound	Lb	18.1	22.5	0.00005
Pound/Once	L oz	18L 1.2oz	22L 7.7oz	0.01
Troy Once	Ozt	264	328	0.0005
Metric Carat	ct	41000	51000	0.05
Momme	mom	2187	2720	0.005
Pennyweight	dwt	5273	6559	0.01
Grain(UK)	GN	126545	157410	0.2
teal(HK general, Singapore)	TL	217	270	0.0005
Teal(HK jewelry)	TL	219	273	0.0005
Teal(Taiwan)	TL	219	272	0.0005
Teal(China)	TL	262	326	0.0005
Tola(India)	Tol	703	875	0.001
Messghal	Mes	1749	2176	0.005

GX/GF-M		GX-12001M GF-12001M	GX-22001M GF-22001M	GX-32001M GF-32001M	
Unit		Capacity	Capacity	Capacity	Minimum display
Gram	g	12200	22200	32200	0.1
Kiloram	kg	12.2	22.20	32.20	0.0001
Once(Avoir)	oz	430	783	1136	0.005
Pound	Lb	26.9	48.9	71.0	0.0005
Pound/Once	L oz	26L 14.3oz	48L 15oz	70L 15.8oz	0.01
Troy Once	Ozt	392	714	1035	0.005
Metric Carat	ct	61000	111000	161000	0.5
Momme	mom	3253	5920	8587	0.05
Pennyweight	dwt	7845	14275	20705	0.1
Grain(UK)	GN	188275	342598	496922	2
Teal(HK general, Singapore)	TL	323	587	852	0.005
Teal(HK jewelry)	TL	326	593	860	0.005
Teal(Taiwan)	TL	325	592	859	0.005
Teal(China)	TL	390	710	1030	0.005
Tola(India)	Tol	1046	1903	2761	0.01
Messghal	Mes	2603	4736	6869	0.05

GX/GF-M		GX-8202MD GF-8202MD			
		Standard range		Precision range	
Unit		Capacity	Minimum display	Capacity	Minimum display
Gram	g	8200	0.1	2200	0.01
Kiloram	kg	8.20	0.0001	2.20	0.0001
Once(Avoir)	oz	289	0.005	77.6	0.0005
Pound	Lb	18.1	0.0005	4.85	0.00005
Pound/Once	L oz	18L 1.2oz	0.01	4L 13.6oz	0.001
Troy Once	Ozt	264	0.005	70.7	0.0005
Metric Carat	ct	41000	0.5	11000	0.05
Momme	mom	2187	0.05	587	0.005
Pennyweight	dwt	5273	0.1	1415	0.01
Grain(UK)	GN	126545	2	33951	0.2
teal(HK general, Singapore)	TL	217	0.005	58.2	0.0005
Teal(HK jewelry)	TL	219	0.005	58.8	0.0005
Teal(Taiwan)	TL	219	0.005	58.7	0.0005
Teal(China)	TL	262	0.005	70.4	0.0005
Tola(India)	Tol	703	0.01	189	0.001
Messghal	Mes	1749	0.05	469	0.005

GX/GF-M		GX-32001MD GF-32001MD			
Unit		Standard range		Precision range	
		Capacity	Minimum display	Capacity	Minimum display
Gram	g	32200	1	6200	0.1
Kiloram	kg	32.2	0.001	6.20	0.0001
Once(Avoir)	oz	1136	0.05	219	0.005
Pound	Lb	71.0	0.005	13.7	0.0005
Pound/Once	L oz	70L 15oz	0.1	13L 10.6oz	0.01
Troy Once	Ozt	1035	0.05	199	0.005
Metric Carat	ct	161000	5	31000	0.5
Momme	mo m	8587	0.5	1653	0.05
Pennyweight	dwt	20705	1	3987	0.1
Grain(UK)	GN	496922	-	95681	-
teal(HK general, Singapore)	TL	852	0.05	164	0.005
Teal(HK jewelry)	TL	860	0.05	165.6	0.005
Teal(Taiwan)	TL	859	0.05	165.3	0.005
Teal(China)	TL	1030	0.05	198.4	0.005
Tola(India)	Tol	2761	0.1	532	0.01
Messghal	Mes	6869	0.5	1323	0.05

## 5-2 Storing Units

The units or modes can be selected and stored in the function table. The sequence of displaying the units or modes can be arranged to fit the frequency of use.

The units stored are maintained in non-volatile memory, even if the AC adapter is removed.

Select a unit or mode and arrange the sequence of display as follows:

- Press and hold the **SAMPLE** key (for 2 seconds) until **bRSFnC** of the function table is displayed, then release the key.
- Press the **SAMPLE** key several times to display **Unit**.
- Press the **PRINT** key to enter the unit selection mode.
- Specify a unit or mode in the order to be displayed using the following keys.
 

<b>SAMPLE</b>	key	To sequentially display the units.
<b>RE-ZERO</b>	key	To specify a unit or mode. The stabilization indicator  appears when the displayed unit or mode is specified. If the key is pressed in units already selected, the stability mark disappears.
- Press the **PRINT** key to store the units or modes. The balance displays **End** and then displays the next menu of the function table.
- Press the **CAL** key to exit the function table. Then the balance returns to the weighing mode with the selected unit.
- To select other unit or mode for weighing, press the **MODE** key.

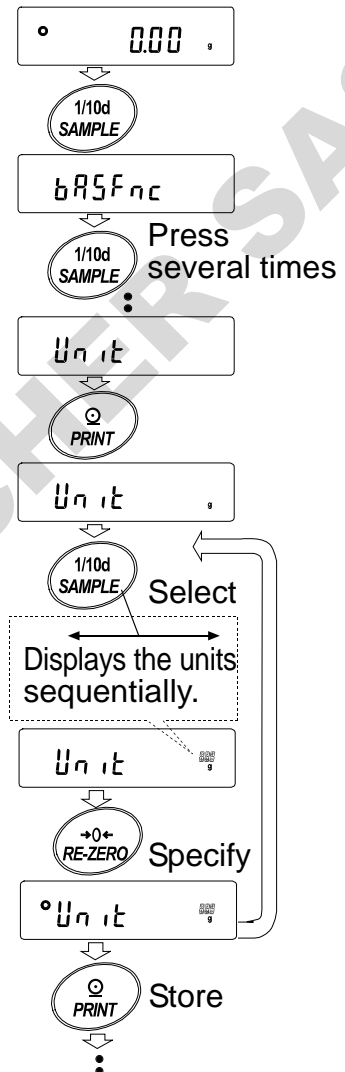

## Unit setting example

The example below sets the units in the order with g (gram) as the first unit followed by pcs (counting mode).

1. Press and hold the **SAMPLE** key (for 2 seconds) until **bRSFnC** of the function table is displayed, then release the key.
2. Press the **SAMPLE** key several times to display **Unit**.
3. Press the **PRINT** key to enter the unit selection mode.
4. Press the **RE-ZERO** key to specify the unit of g. The stabilization indicator **°** appears when the unit is specified.
5. Press the **SAMPLE** key to display **Unit PCS**.
6. Press the **RE-ZERO** key to specify the unit of pcs. The stabilization indicator **°** appears when the unit is specified.
7. Press the **PRINT** key to store the units. The balance displays **End** and then displays the next menu item of the function table.
8. Press the **CAL** key to exit the function table. Then the balance returns to the weighing mode with g, the unit selected first.
9. Press the **MODE** key to switch between g and pcs (g→pcs).

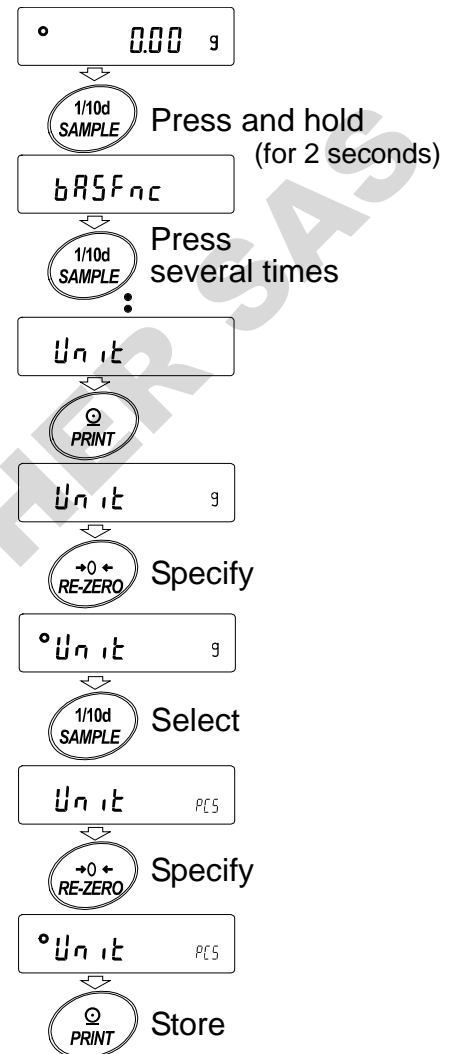

# 6. Weighing

## 6-1 Basic Operation

1. Press **MODE** key, and then select the appropriate units

In this case, select "g".

2. Place a container on the weighing pan, if necessary.  
Press the **RE-ZERO** key to cancel the weight (tare).

The balance displays **0.00 g**. (The decimal point position depends on the balance model.)

3. Place a sample on the pan or in the container. Wait for the stabilization

indicator **○** to be displayed. Read the value.

Remove the sample and container from the pan.

### Note

- Press the **SAMPLE** key to turn on or off the minimum weighing value.
- The weighing data can be stored in memory. For details, refer to "13. Data Memory".
- When the **ON:OFF** key is pressed with a container placed on the weighing pan and weighing is started, the balance automatically cancels the weight (tare) and displays **0.00 g**.

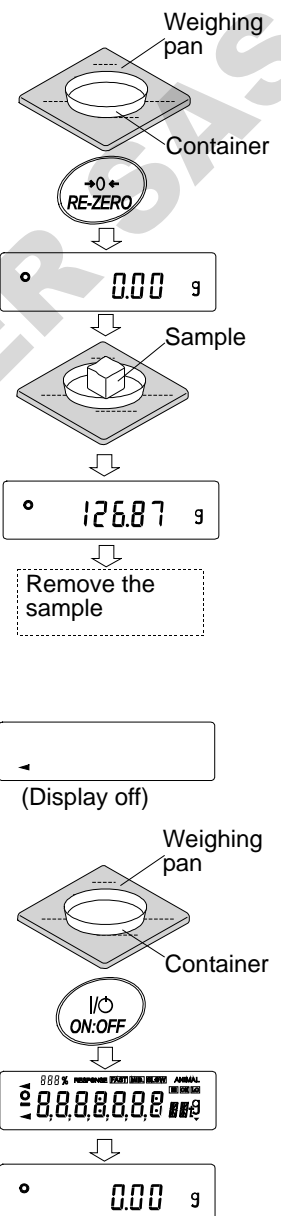



#### About the operation at when power is turned on

The balance will decide the reference zero point when the power is turned on (AC adapter is connected).

Depending on the load condition at that time, it will automatically judge whether to perform zero or tare operation. The condition for determining which is used is "power on zero range", and when power on zero range is exceeded, the tare subtraction operation is performed.

#### About re-zero operation

By pressing the **RE-ZERO** key, the display can be changed to zero.

Re-zero with the **RE-ZERO** key will automatically determine whether zero or tare operation is performed.

The condition for determining which is used is "zero range", and when zero range is exceeded, the tare subtraction operation is performed.

#### About measurement range

For the balance, the range that can be weighed is determined by model.

The total amount (net amount + tare quantity) up to the maximum display of each model is displayed, and when the maximum display is exceeded, **E** is displayed to indicate that the weighing range is exceeded.

When in excess in negative, **-E** is displayed.

Model	Power on zero range	Zero range	-E display range
GX-8202M, GF-8202M	Approx. $\pm 1$ kg	Approx. $\pm 160$ g	Approx. -1kg or less
GX-8202MD, GF-8202MD		Approx. $\pm 160$ g	
GX-10202M, GF-10202M		Approx. $\pm 200$ g	
GX-12001M, GF-12001M	Approx. $\pm 3$ kg	Approx. $\pm 200$ g	Approx. -3kg or less
GX-22001M, GF-22001M		Approx. $\pm 400$ g	
GX-32001M, GF-32001M		Approx. $\pm 600$ g	
GX-32001MD, GF-32001MD		Approx. $\pm 600$ g	

## 6-2 Counting Mode (PCS)

This is the mode to determine the number of objects in a sample based on the standard sample unit mass. Unit mass means the mass of one sample. The smaller the variables in each sample unit mass is, the more accurate the counting will be. This series balance is equipped with the Automatic Counting Accuracy Improvement (ACAI) function to improve the counting accuracy.

### Note

- \* For counting, use samples that have a unit mass at least ten times greater than that of the minimum display in grams.
- \* If the sample unit mass variable is too large, it may cause a counting error.
- \* To improve the counting performance, use the ACAI function frequently or divide the samples into several groups and count each group.

### Selecting the counting mode

1. Press the **MODE** key to select **PCS** ( $PCS = \text{unit}$ )

### Storing a sample unit mass

2. Press the **SAMPLE** key to enter the sample unit mass storing mode.
3. To select the number of samples, press the **SAMPLE** key several times. It may be set to 5, 10, 25, 50 or 100.

### Note

A greater number of samples will yield more accurate counting result.

Place a container on the weighing pan, if necessary.

Press the **RE-ZERO** key to cancel the weight (tare). The number specified in step 3 appears.

**25 0** is displayed if 25 is selected in "3".

4. Place the number of samples specified on the pan. In this example, 25 pieces.
5. When **PRINT** key pressed, unit mass is stored and changes the count display. (Ex: when the number is 25, **25 PCS** is displayed.

### Note

- \* If the balance judges that the mass of the samples is too light to acquire accurate weighing, it displays an error requiring the addition of more samples to the specified number and press the **PRINT** key. When the unit mass is stored correctly, the balance proceeds to the counting mode.
- \* If the balance judges that the mass of the samples is too light and is not adequate to be used as the unit mass, it displays **Lo**.
- \* Registered unit mass is remembered even when the power is turned off.

### Number mode (counting)

6. Counting is possible.

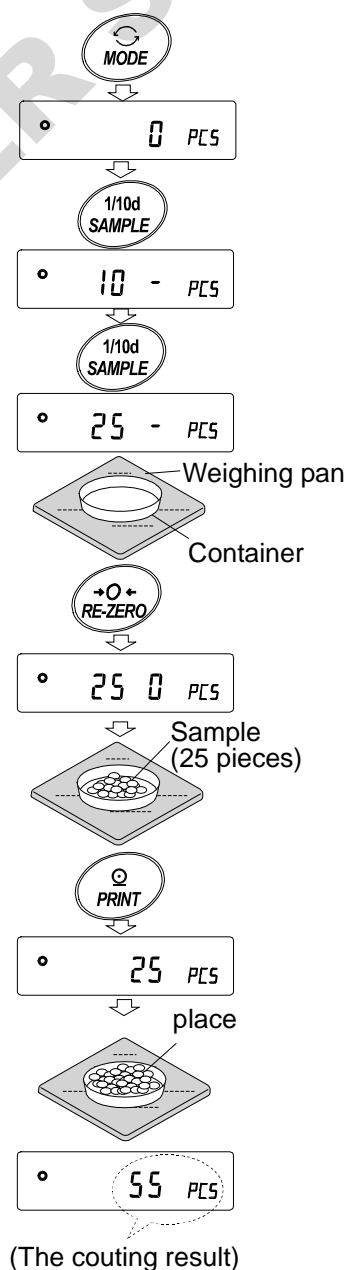

## Counting Mode Using The ACAI Function

The ACAI is a function that improves the accuracy of the unit mass automatically by increasing the number of samples as the counting process.

ACAI: Automatic Counting Accuracy Improvement

After registering unit mass of "5", proceed to the following "7".

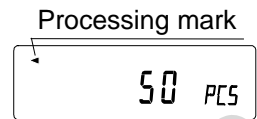

7. If a few more samples are added, the processing indicator turns on. To prevent an error, add three or more. The processing indicator does not turn on if overloaded. Try to add the same number of samples as displayed.
8. The balance re-calculates the unit mass while the processing indicator is blinking. Do not touch the balance or samples on the pan until the processing indicator turns off.
9. Counting accuracy is improved when the processing indicator turns off.
10. Each time the above operation is performed, a more accurate unit mass will be obtained. There is no definite upper limit of ACAI range for the number of samples exceeding 100. Try to add the same number of samples as displayed.
11. Remove all the samples used in ACAI and proceed with the counting operation using the improved unit mass.

**Note** ACAI will not function on the unit mass entered using the keys, or digital input mode.

## Storing the unit mass

By using the data memory function, 50 instances of storing a sample unit mass can be stored.

1. Set the function setting item "Data memory function (DATA)" to "Stores unit mass in counting (DATA1)". Refer to "11.Function Table".
2. The displayed "P \*\*" is the selected unit mass registration number.
3. Press and hold the **PRINT** key (for 2 seconds) to switch to the mode to change the unit mass registration number.

**RE-ZERO** key ..... Changes the registration number(+)

**MODE** key ..... Changes the registration number (-)

**PRINT** key ..... Decides on the displayed registration number.

**CAL** key ..... Cancel the displayed registration number.

4. Multiple unit masses can be stored by registering them with different unit mass registration numbers.

### Note

- \* P \*\*: The unit weight registration number is entered.
- \* Unit weight can be read by "UN:mm" command.  
(mm corresponds to P01 to P50 with 01 to 50.)
- \* The read unit mass can output by "?UW" command and can be changed by "UW" command.

### Note

- \* ACAI cannot be used for the read unit mass.

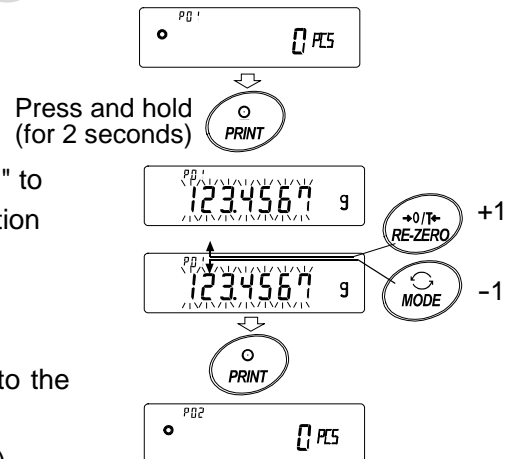

## 6-3 Percent Mode (%)

The percent mode displays the weighting value in percentage compared to a 100% reference mass and is used for target weighing or checking the sample variance.

### Selecting The Percent Mode

1. Press the **MODE** key to select the unit **%** (Percent mode).

### Storing The 100% Reference Mass

2. Press the **SAMPLE** key to enter the 100% reference mass storing mode.

Even in the storing mode, pressing the **MODE** key will switch to the next mode.

3. Place a container on the weighing pan, if necessary. Press the **RE-ZERO** key to cancel the weight (tare). The balance displays **100.0 %**.
4. Place the sample to be set as the 100% reference mass on the pan or in the container.
5. Press the **PRINT** key to store the reference mass.

The balance displays **10000 %**. (The decimal point position depends on the reference value. The reference mass stored, even if the AC adapter is removed, is maintained in non-volatile memory.)

### Note

- If the balance judges that the mass of the sample is too light to be used as a reference, it displays **Lo**.
- The displayed percentage is based on the 100% reference mass.

Model	100% mass	Decimal point position
Minimum display 0.01g	1.00g ~ 9.99g	1%
	10.00g ~ 99.99g	0.1%
	100.00g ~	0.01%
Minimum display 0.1g	10.0g ~ 99.9g	1%
	100.0g ~ 999.9g	0.1%
	1000.0g ~	0.01%

- Registered values are stored even when the power is turned off.

6. Remove the sample

### Reading the percentage

7. Please a sample to be compared to the reference mass on the pan.  
The displayed percentage is based on the 100% reference mass.

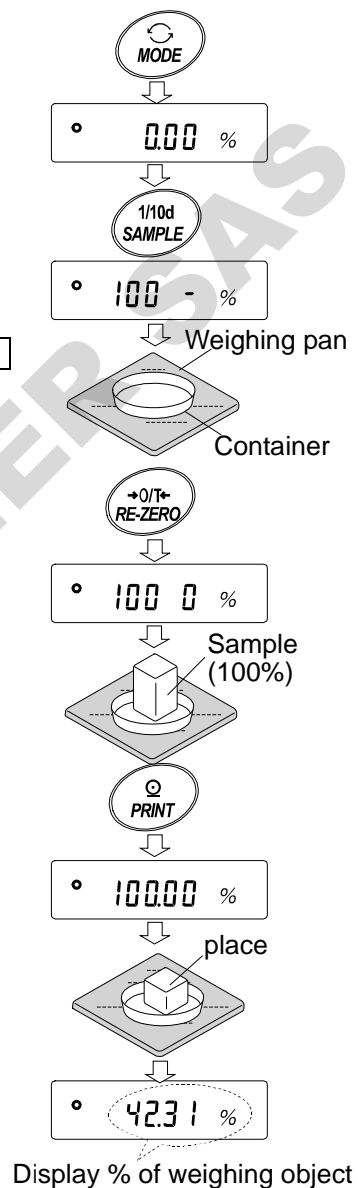

## 6-4 Animal Weighing Mode (Hold Function)

This is the mode to weigh a moving object such as an animal, even when the display of the weighing data fluctuates. The hold function allows the average weight of the animal to be displayed. To use the hold function, set the function in the function table. Refer to "11. Function Table" and "11-3. Description Of The Class "Environment, Display" for details.

DOMINIQUE DUTSCHER SAS

## 7. Impact Detection Function





The GX-M / GF-M series has a function to detect impact to the mass sensor section and to display the impact level.

By lowering the impact level at the time of loading, it is possible not only to alleviate variation in the weighing value but also to reduce the risk of failure of the mass sensor section.

Especially when incorporating the balance in a production line, etc. and weighing by means such as an automated system, impact to the sensor may be applied greater than expected.

When designing automatic systems and the like, it is recommended that you minimize the impact level as much as possible while checking the shock indicator.

Impact level display is from level 0 to level 4, 5level.

Impact level	Shock indicator	Buzzer	Contents
0	No	No	Safe
1	SHOCK 	No	Caution
2	SHOCK 	No	Caution : Consider impact mitigation
3	SHOCK 	One beep	Warning : Do not apply greater impact
4	SHOCK 	Two beep	Danger : Sensor may be damaged

### Note

- Impact on the weighing sensor may be applied to the weighing pan at time of loading, or it may be applied from the table on which the balance is installed.

The impact detection function also works for impact applied from the table.

## 7-1 Recording Impact History

Impacts of impact level 3 or higher are stored on the balance with data and time included (maximum 50 data instances).

When the password lock function is on (Lock 1 or Lock 2), the login user information is added when outputting the impact history.

### Note

- If 50 data instances is exceeded, the data with the lowest impact level is overwritten.
- The stored impact history cannot be deleted.
- Impact data where the balance is not energized (during transport, etc.) is not stored.

## 7-2 Output Impact History

The stored impact history can be output by sending a specified command to the balance or performing a key operation.

### Output by command

The stored impact data will be output all at once by sending a ?SA command to the balance.

### Output by key operation

1. Press the **ON:OFF** key to turn off the display.
2. With the display off, press the **ON:OFF** key while holding down the **MODE** key.
3. **-L 15t-** is displayed, and the stored impact data is output all at once.

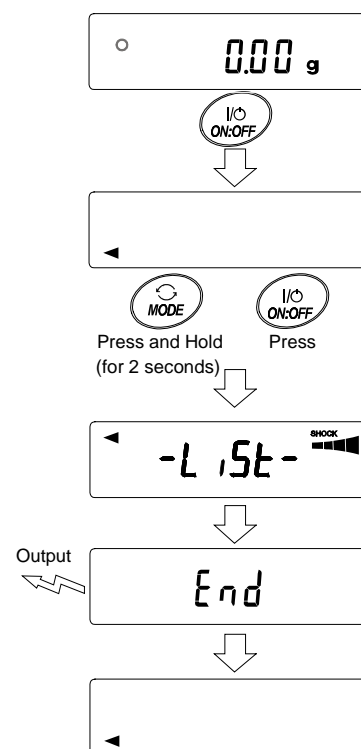

### Impact history output example

Date, time, impact level, login and login user information are output together on one line.

The login user information varies by the setting of the login user and the setting of Function table *Lock* when receiving impact.

Output	Login user	Function table <i>Lock</i>
, --,	No login user	0, 1, 2
,00, ADMIN	Administrator	1
,01~10,USER	User	1
, --,GUEST	Guest	2



Output example

```
2018/05/29,11:08:18,SHOCK LV,3, --,  
2018/05/29,11:12:27,SHOCK LV,4,00,ADMIN  
2018/05/29,11:13:38,SHOCK LV,3,01,USER  
2018/05/29,11:17:04,SHOCK LV,4, -- ,GUEST
```



## 8. Response Adjustment / Self Check Function

This function stabilizes the weight value, reducing the influence on weighing that is caused by drafts and/or vibration at the place where the balance is installed. This function adjusts by automatically analyzing the environment or by hand-operation. The function has three stages as follows : Changing the weighing speed changes the display refresh rate.

Display	Function setting	Response characteristic
FAST	Cond 0	Fast response, Sensitive value   Slow response, Stable value
MID.	Cond 1	
SLOW	Cond 2	

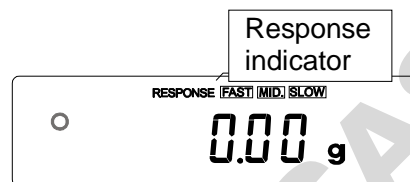

### 8-1 Response Adjustment

Response adjustment can be changed by the following method.

1. Press and hold the **MODE** key (for 2 seconds) until **RESPONSE** is displayed, and then release the key.
  2. Press the **MODE** key to select a weighing speed. Either **FAST**, **MID** or **SLOW** can be selected.
  3. After a few seconds of inactivity the balance displays **End**.
  4. Then, it returns to the weighing mode and displays the updated response indicator.
- The response indicator remains displayed for a while.

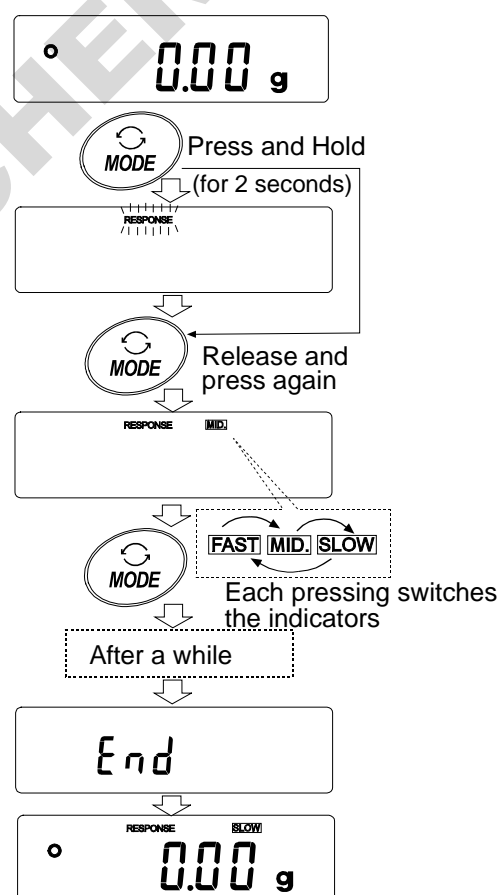

#### Note

When setting the Response adjustment, "Condition Cond" and "Display refresh rate SPd" in the 11.Function Table "Environment display bRSFnc" are changed as below.

Display	Cond (Condition)	SPd (Display refresh rate)	St-b (Stability bad width)
FAST	0	2	2
MID.	1	0	1
SLOW	2	0	1

When using a combination other than the above, please set individually as shown in "11. Function Table".

#### Note

If **RESPONSE** is displayed and you leave without pressing the **MODE** key, the "Self-check function" is activated. Please refer to "8-2. Self-Check-Function / Automatic Setting Of Minimum Weight Value".  
For the setting method, refer to "11.Function Table".

## 8-2 Self-Check-Function / Automatic Setting Of Minimum Weight Value

The self-check function can easily check about whether proper performances are satisfied for the balance by checking and displaying repeatability in addition to malfunction check.

In addition, it can also display and store minimum weighing value (reference value) using data of the repeatability.

Refer to "Balance information" on the A&D web site <<http://www.aandd.co.jp/>> for details of the minimum weighing value.

### Setting procedure (Together refer to setting flow chart on next page.)

1. Press and hold the **MODE** key (for 2 seconds) in weighing mode.

2. Release the key after displaying **RESPONSE**.

3. Display shows **[H:0.0000]** and self-check function is started.

After few seconds, display shows "ECL".

Press the **MODE** key while **[H:0.0000]** is displayed to observe changes in the weighing value of the repeatability using electronic control load (ECL).

4. Display shows a check result after check. When there is no error in the balance, display shows

**[H PASS]** in blinking. When display shows **[H FAIL]** in blinking, there is a possibility that serious malfunctions occurs in the balance. In such case, the balance requires repair.

**[SAMPLE]** key····Switches a display among check result, repeatability and minimum weighing value (reference value).

**[PRINT]** key·····Outputs currently displayed contents

At repeatability display, display shows "OK" if it is satisfied for catalog spec.

However, if it is not satisfied for catalog spec, display requests an improvement in an environment for the balance installed by blinking "Env"

**[MODE]** key·····Switches an allowable measurement error of the minimum weighing value (reference value).

Use the following keys while the minimum weighing value (reference value) is displayed to perform each operation.

5. Outputting data of the minimum weighing value at once

Press and hold the **[PRINT]** key (for 2 seconds) to display **[out]**. After outputting at once, **[End]** is displayed.

6. Storing as minimum weighing value (reference value) of "17. Minimum Weighing Warning Function"

Press and hold the **[SAMPLE]** key (for 2 seconds) to display **[MW SET]**. Minimum weighing value (reference value) is stored. After storing, display shows **[End]** and returns to weighing mode.

7. When not storing

Press the **[CAL]** key to return to weighing mode after displaying **[End]**.

8. To return to check result display

Press the **[SAMPLE]** key to return to check result display in Step 4.

\* Refer to "17. Minimum Weighing Warning Function" for warning function of minimum weighing value.

### Setting flow chart

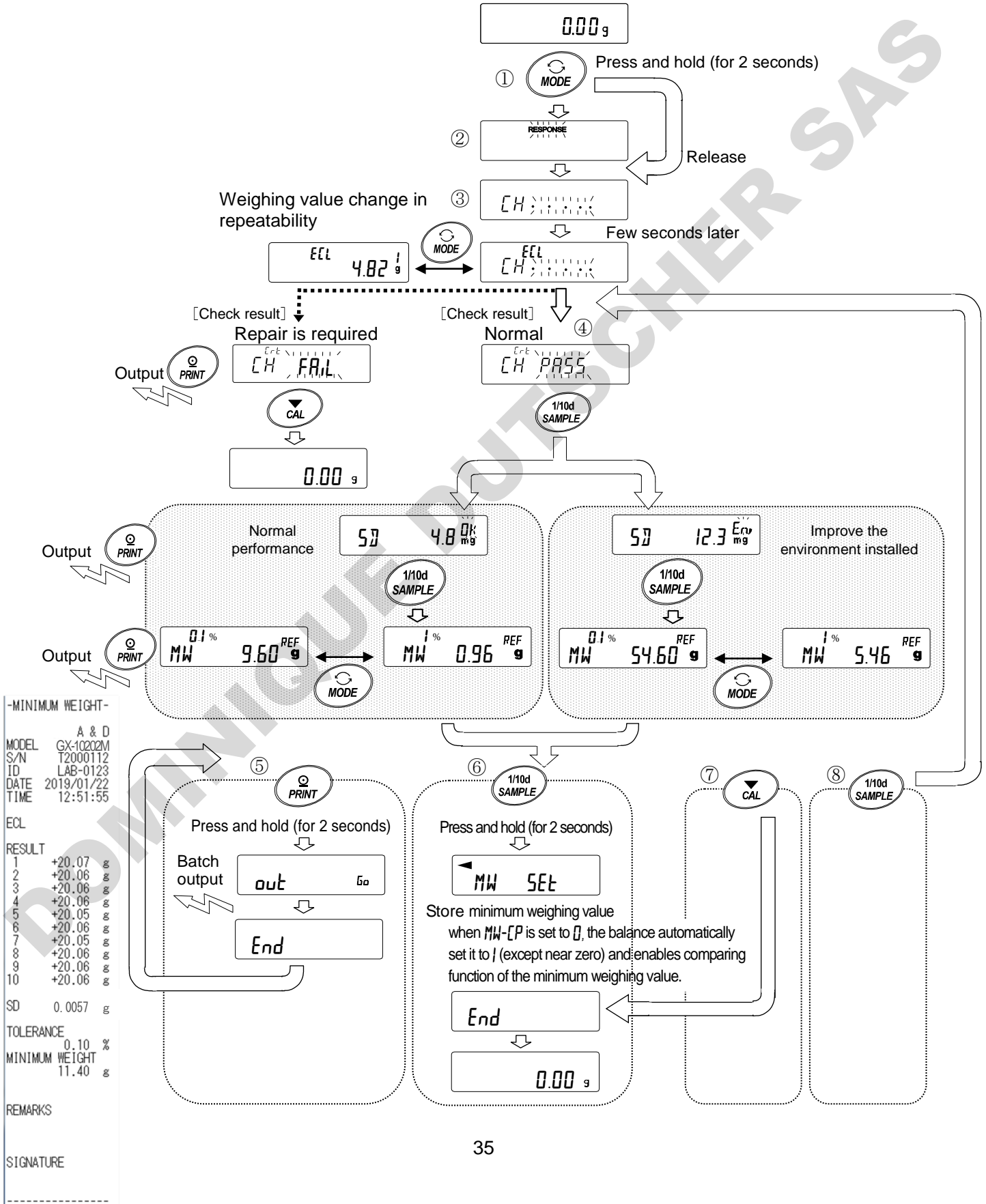

## 9. Calibration

Since the balance's resolution is high, weighing values may change due to gravity and daily environmental changes. It is necessary to perform calibration (sensitivity adjustment) with the weight in order to keep the weighing values from changing even if gravity or the environment changes.

It is recommended that you calibrate if the balance is installed for the first time or relocated, or when the weighing values change significantly in daily inspection, etc.

Adjustment means to adjust the weighing value of the balance using the reference weight or internal mass. Calibration is to weigh with the reference weight and compare how much the result deviates from the reference value. (Adjustment is not performed in calibration.)

### Calibration (Sensitivity adjustment)

- Auto calibration..... Automatically adjust the balance using the internal mass depending on the temperature change of the operating environment or the set time and interval time. (GX-M series)
- Calibration using the internal mass ..... Using the internal mass, adjust the balance with a single touch.
- Calibration using an external weight..... Using an external mass, adjust the balance with an external mass.

### Calibration test (Sensitivity calibration)

- Calibration test with an external weight..... Output the result of checking the accuracy of weighing using your own weight.
- \* No adjustment is made.

### Caution

- Do not allow vibration or drafts to affect the balance during calibration.
- To output the data for GLP/GMP using the RS-232C interface, set "GLP/GMP output (INF0)" of "Data output (dout)". Refer to "11. Function Table". The time and date can be added to the GLP/GMP report. If the time or date is not correct, adjust them. Refer to "11-7 Clock and Calendar Function".
- The calibration and calibration test data can be stored in memory. To store them, set "Data memory (dRtR)".

### Caution when using your external weight

- The accuracy of the weight used in calibration affects the accuracy of the balance after calibration.
- Select the mass to be used for calibration and calibration tests from the table below.

Model	Usable calibration weight	Factory setting	Adjustable range
GX-8202M, GF-8202M	2kg to 8kg (1kg interval)	5kg	-99.99g to +99.99g
GX-8202MD, GF-8202MD	2kg to 8kg (1kg interval)	5kg	
GX-10202M, GF-10202M	2kg to 10kg (1kg interval)	10kg	
GX-12001M, GF-12001M	5kg, 10kg	10kg	-999.9g to +999.9g
GX-22001M, GF-22001M	5kg, 10kg, 20kg	20kg	
GX-32001M, GF-32001M	5kg, 10kg, 20kg, 30kg	20kg	
GX-32001MD, GF-32001MD	5kg, 10kg, 20kg, 30kg	20kg	

### Display



This indicator means "In process of measuring calibration data".

Do not allow vibration or drafts to affect the balance while the indicator is displayed.

## 9-1 Automatic Self Calibration For The GX-M Series

This function automatically calibrates the balance using the internal weight due to a temperature change in the ambient environment, time set or interval time. It can function even when the balance's display is in off. If GLP output in function table is selected, the balance outputs the sensitivity adjustment report or store the data in memory after calibration.

In the auto calibration mode, either the temperature change ([Fnc 0]), the setting time ([Fnc 1]), or the interval time ([Fnc 3]) can be set with the function setting [Fnc].

For the setting time, the three function setting of [TIME 1], [TIME 2] and [TIME 3] can be set.

Interval time can be set from 0.5h to 24h with function setting [int].

### Caution

If something is on the weighing pan, the balance judges that it is in use and does not perform automatic self calibration.

The criteria that the balance judges is in use are as follows.

0.01g models	0.1g models
More than 20g	More than 200g

To maintain the calibrated state, keep the weighing pan clear while not in use.



Indicates that the balance detects a change in ambient temperature and automatic self calibration will start. If the balance is not used for a few minutes with this indicator (▶) blinking, the balance performs automatic self calibration. The blinking duration depends on the environment.



Indicates that the balance is measuring calibration data. Do not allow vibration or drafts to affect the balance while this indicator is displayed. After calibration, the balance returns to indicate the previous display.

**Note** The balance can be used while the indicator blinks. But, it is recommended that to maintain the accuracy, stop using the balance and confirm that there is nothing on the pan and allow the balance to perform self calibration.

Depending on the setting of "10.Function Switch And Initialization", "change prohibited" or "changeable (usable)" can be selected.

## 9-2 One-Touch Calibration For The GX-M Series

This function calibrates the balance using the internal mass.

1. Connect the AC adapter and warm up the balance for at least 30 minutes with nothing on the weighing pan.
2. Press the **CAL** key. The balance displays **CAL in** and performs calibration using the internal mass. Do not allow vibration or drafts to affect the balance.
3. The balance displays **End** after calibration. If the "GLP output (inF0)" parameter of the function table is set to "1" or "2", the balance displays **GLP** and outputs the "sensitivity adjustment report" using the RS-232C interface or store the data in memory. Refer to "12-3. GLP Report" and "Data memory (dRR)" of the function table for details.
4. The balance will automatically return to the weighing mode after calibration.

### About the internal mass

The value of the internal mass may change due to factors such as the operating environment and aging. Correct the internal mass value as necessary. Refer to "9-6. Correcting The Internal Mass Value Of The GX-M series", "9-7. Correcting The Internal Mass Value Of The GX-M series (Auto)".

Since the internal mass is about 850g, the possibility of error may increase as the weighing value increases.

To maintain the weighing accuracy, perform the calibration using an external weight periodically, as described below "9-3. Calibration Using An External Weight".

## 9-3 Calibration Using An External Weight

This function calibrates the balance using an external weight.

1. Connect the AC adapter and warm up the balance for at least 30 minutes with nothing on the weighing pan.
2. Press and hold the **[CAL]** key (for 2 seconds) until **[CAL out]** is displayed, then release the key.
3. Make sure that nothing is on the weighing pan and press the **[PRINT]** key to weigh the zero point. Do not apply vibration, etc.
4. Place the external weight on the weighing pan and press the **[PRINT]** key. Do not apply vibration etc.
5. Remove the external weight from the weighing pan.
6. After calibration, if GLP output is set, "sensitivity adjustment report" is output or stored in data memory.
7. The display automatically returns to weighing display.
8. Place the external weight again and check that the set value is  $\pm 2$  digits. If it is out of "9-5.How to set the external weight value" range, pay attention to the surrounding environment and start from "1".

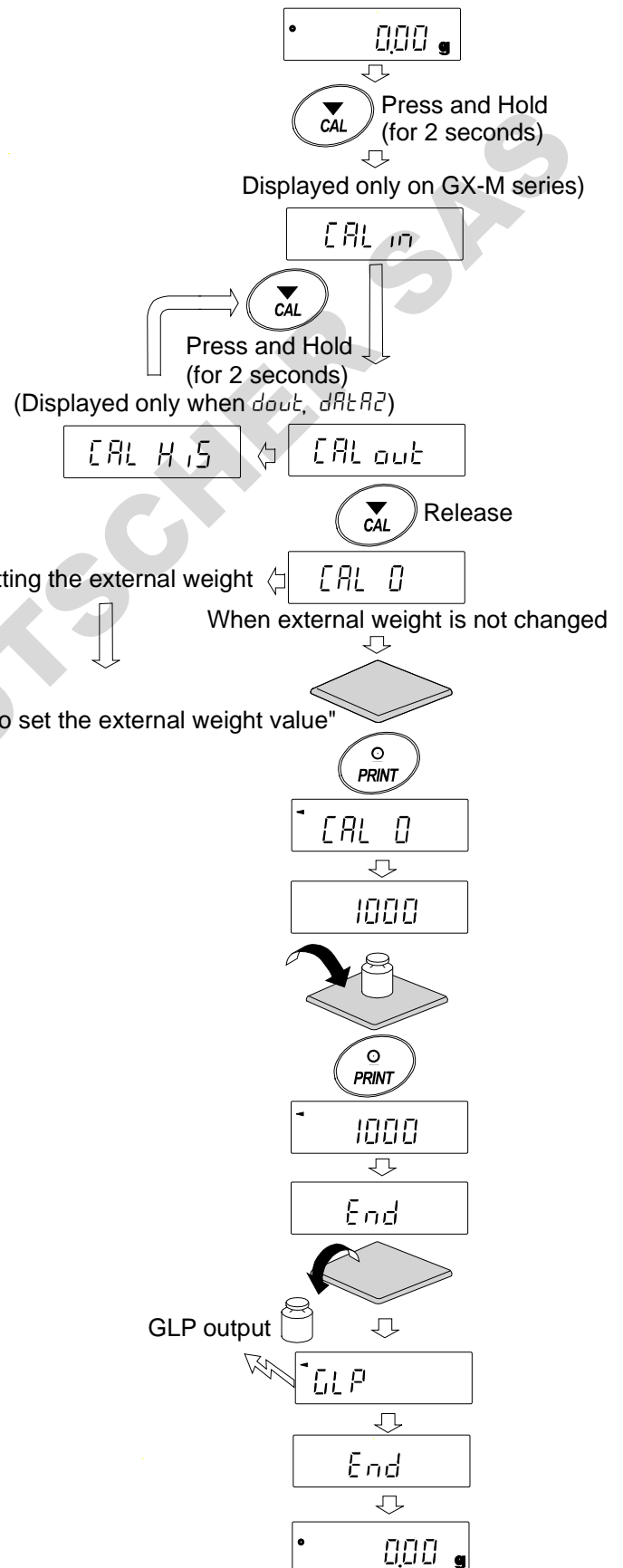

## 9-4 Calibration Test Using An External Weight

This function tests the weighing accuracy using an external weight and outputs the result. This is available only when the GLP output parameter is set to "( *dout info* )". (Calibration test does not perform calibration)

1. Connect the AC adapter and warm up the balance for at least 30 minutes with nothing on the weighing pan.
2. Press and hold the **CAL** key (for 2 seconds) until **[[out** is displayed and release the key.
3. Make sure that nothing is on the weighing pan and press the **PRINT** key and weigh the zero point. Do not apply vibration etc.
4. The weighing value of zero point is displayed for several seconds. Place the external weight on the weighing pan and press the **PRINT** key. Weigh the external weight. Do not apply vibration, etc.
5. Weighing value of the external weight is displayed for several seconds.
6. Remove the external weight from the weighing pan.
7. The **sensitivity** calibration status is output or stored in the data memory.
8. It automatically returns to the weighing display.

(Displayed only when *dout, dAtA2*)(Displayed only on GX-M series)

When setting the external weight

Refer to "9-5. How to set the external weight value."

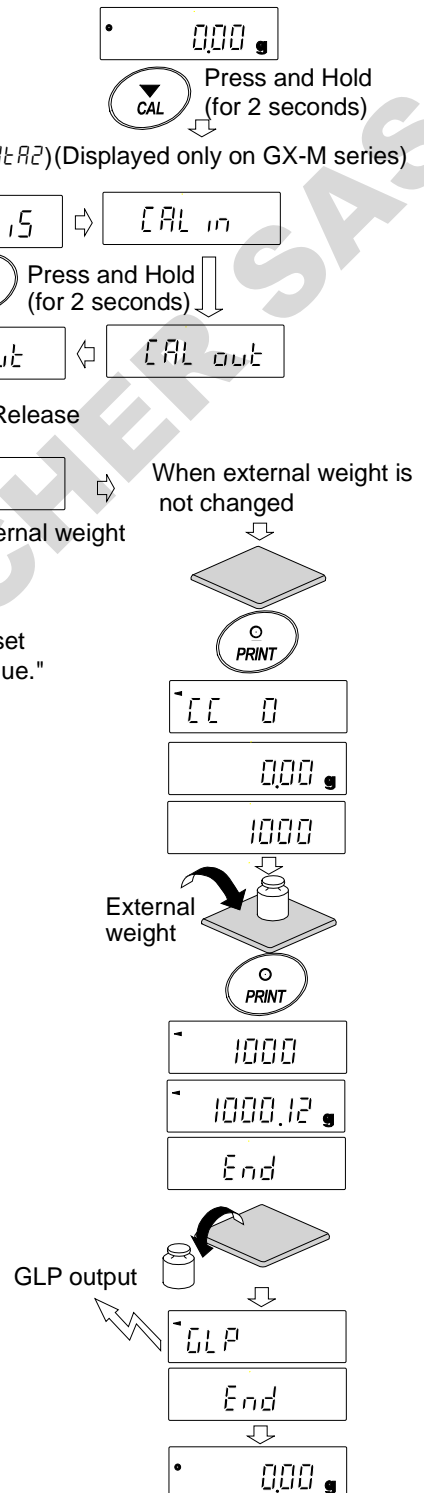



## 9-5 How to set the External Weight Value

When calibrating the balance or performing a calibration test, the external weight you have on hand can be set. (Refer to "Usable calibration weight" on Page 37.)

After [CAL 0] is displayed, the external weight value can be set as shown in "9-3.Calibration Using An External weight". Or, after [CC 0] is displayed, the external weight value can be set as shown in "9-4.Calibration Test Using An External Weight".

1. After displayed [CAL 0] , or after displayed [CC 0] , press the [SAMPLE] key.
2. Press the [RE-ZERO] key at all digits blinking to change the weight to be used.

3. Specify the calibration weight value as follows.

- [SAMPLE] key..... Switches the display condition to: "All of the segments blinking" (calibration weight selection mode) or "The last four digits blinking"(value adjustment mode).
- [RE-ZERO] key ..... Changes the external weight value (all of the segments blinking) or changes the adjustment range (last four digits blinking). In the adjustment range setting, the value becomes -9999 digits after +9999 digits.
- [MODE] key
- [PRINT] key..... Registers the changed external weight value. Registered values are stored even when the power is turned off.
- [CAL] key ..... Suspends setting. (Returns to [CAL 0] or [CC 0] .)

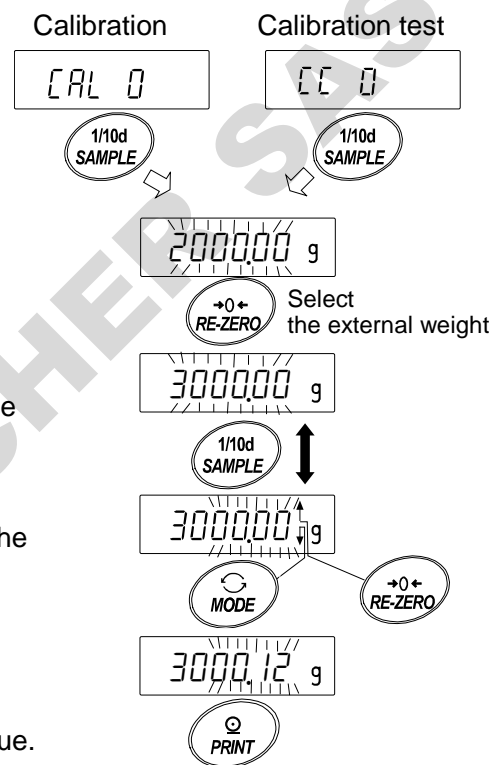

Ex: Updated the external weight 3000.12g

## 9-6 Correcting The Internal Mass Value Of The GX-M series

Internal mass value can be corrected with function setting [5] 17.

There is one correction method, as follows.

Auto ..... This is a method of correcting the internal mass weight value based on an external weight.

### Note

- Correction of internal mass value can not be executed at factory setting.  
Refer to "9. Function Switch And Initialization" or the following setting method, and enable changing of the function setting and correction the internal mass value.

### Setting procedure

1. Press the [ON:OFF] key to turn off the display.
2. Hold down the [PRINT] and [SAMPLE] keys, and press the [ON:OFF] key to display P5.
3. Press the [PRINT] key and set the "internal mass correction switch" and "function setting switch" to "1" with the next key.

[SAMPLE] key Select the switch (blinking digit).

[RE-ZERO] key Change the value of the blinking switch.

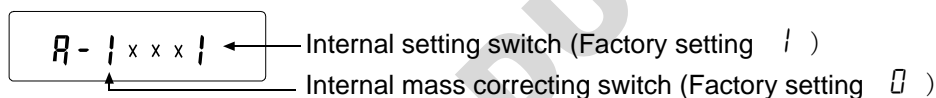

4. Press the [PRINT] key to register and display the weighing display.

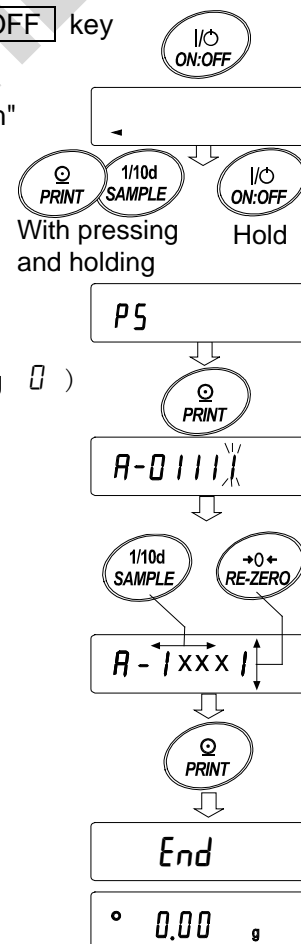

## 9-7 Correcting The Internal Mass Value Of The GX-M series (Auto)

Calibrate referring to "9-3. Calibration Using An External weight".

This is method of correcting the internal mass weight value based on an external weight. After calibration with the external mass, the balance automatically loads and unloads the internal mass and corrects the internal mass value.

The available masses are as shown in the table below. The corrected mass value is maintained in non-volatile memory even if the AC adapter is removed

Model	Available mass	Factory setting	Adjustable range
GX-8202M	2kg to 8kg (1kg interval)	5kg	-99.99g to +99.99g
GX-8202MD	2kg to 8kg (1kg interval)	5kg	
GX-10202M	2kg to 10kg (1kg interval)	10kg	-999.9g to +999.9g
GX-12001M	5kg, 10kg	10kg	
GX-22001M	5kg, 10kg, 20kg	20kg	-999.9g to +999.9g
GX-32001M	5kg, 10kg, 20kg, 30kg	20kg	
GX-32001MD	5kg, 10kg, 20kg, 30kg	20kg	

### Setting procedure

- The internal mass value cannot be corrected at factory settings. Refer to "9-6. Correcting The Internal Mass Value Of The GX-M series" and enable changing of the function setting and correction the internal mass value.
- In weighing mode, press and hold the **[SAMPLE]** key to display **bASFnC**.
- Press the **[SAMPLE]** key several times until **[5 in]** appears.
- If **[5 in]** does not display, perform "1".
- Press the **[PRINT]** key to display **Auto**.
- When preparation is completed, press the **[PRINT]** key.
- [CAL. SET]** is displayed and the internal mass value is automatically corrected.
- When adjustment of the internal mass value is completed, **[CAL. in]** is displayed and calibration is performed automatically with the adjusted internal weight.
- When calibration is completed, **[MANUAL]** is displayed. Press the **[CAL]** key twice to return to weighing mode.
- Place the external weight used for calibration on the balance to check whether the balance was corrected. If it is not corrected properly, return to "2".

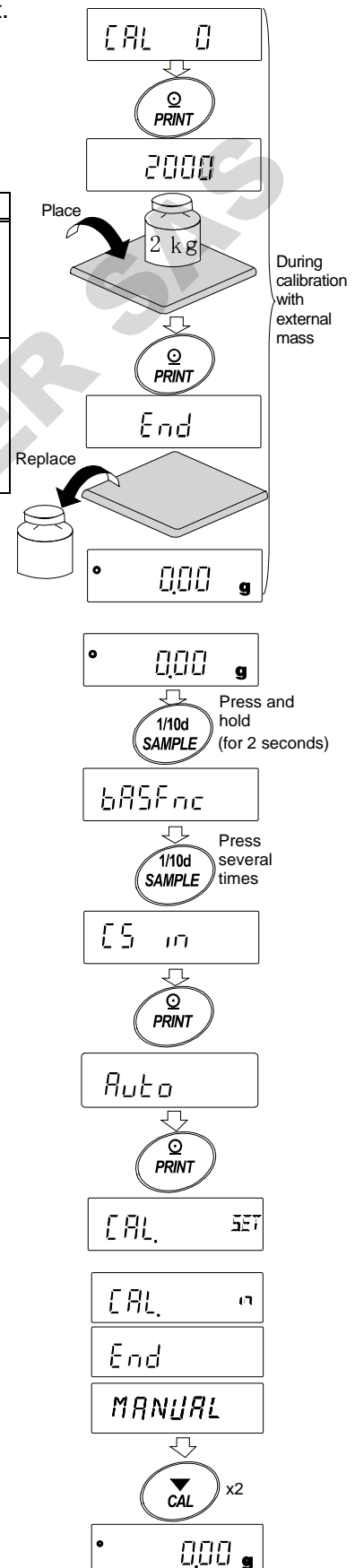

# 10.Function Switch And Initialization

## 10-1Permit Or Inhibit

The balance stores parameters that must not be changed unintentionally adjustment data for accurately weighing, data for adapting to the usage environment, data to control the communications interface, etc. "A function selection switch" is provided to protect those parameters and it can be used to select "change prohibited" or "changeable (usable)". By setting to "change prohibited", that function cannot be entered, so inadvertent change.

"Switch for function selection" has the following five.

"Function table", "Calibration using the internal mass", "Calibration using the external weight", "Automatic self calibration", "Internal mass correction".

1. Press the **ON:OFF** key to turn off the display.
2. While pressing and holding the **PRINT** key and the **SAMPLE** key, press the **ON:OFF** key to display **P5**.
3. Press the **PRINT** key. Then the balance displays the function switches.
  - SAMPLE** key .... To select a switch to change the parameter. The selected switch blinks.
  - RE-ZERO** key..... To change the parameter of the switch selected.
    - To inhibit changes. (Can not be used.)
    - To permit changes. (Can be used.)
  - PRINT** key ..... To store the new parameter and return to the weighing mode.
  - CAL** key..... To cancel the operation (display **Err**) . Press the **CAL** key and return to the weighing mode

### Example of GX-M series

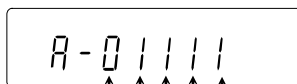

The display shown left indicates the factory settings.

Function table

- To inhibit changes to the function table.
- To permit changes to the function table.

Calibration using the internal mass (One-touch calibration)

- To inhibit calibration using the internal mass.
- To permit calibration using the internal mass.

Calibration using an external weight

- To inhibit calibration using an external weight.
- To permit calibration using an external weight.

Automatic self calibration (Calibration due to changes in temperature)

- To inhibit automatic self calibration.
- To permit automatic self calibration.

Internal mass correction

- To inhibit correction
- To permit correction

**Example of GX-M series**



The display shown left indicates the factory settings.

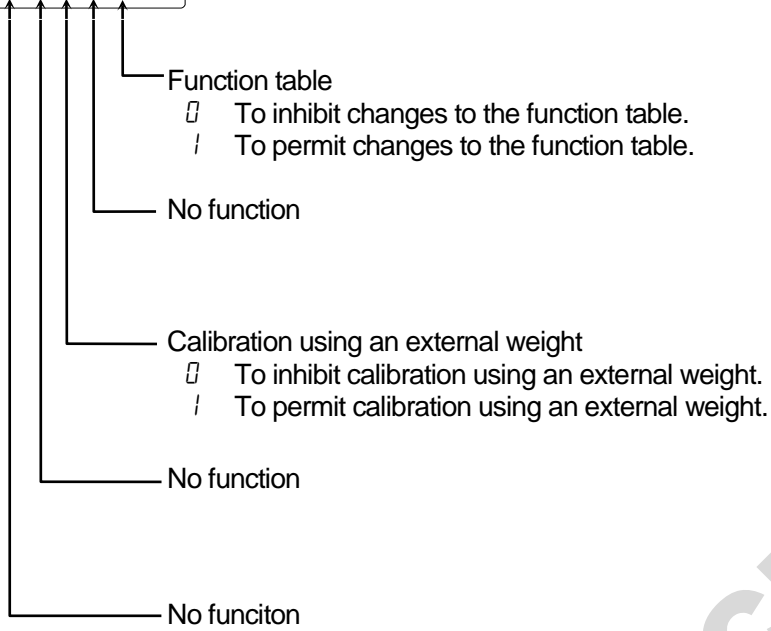

DOMINIQUE DUTSCHER SAS

## 10-2 Initializing The Balance

This function returns the following parameters to factory settings.

- Calibration data
- Function table
  - The sample unit mass value (counting mode),
  - 100% reference mass value (percent mode)
- The data that is stored in the balance using the data memory function
- External calibration weight
- Function switch settings
- Density of a liquid and a water temperature at density mode

**Note** Be sure to calibrate the balance after initialization.

### Setting procedure

1. Press the **ON:OFF** key to turn off the display.
2. While pressing and holding the **PRINT** key and the **SAMPLE** key, press the **ON:OFF** key to display **PS**.
3. Press the **SAMPLE** key to display **[Lr]**.
4. Press the **PRINT** key.  
To cancel this operation, press the **CAL** key.
5. Press the **RE-ZERO** key to change **N<sub>d</sub> / G<sub>d</sub>**.
6. With displaying **[Lr, G<sub>d</sub>]** press the **PRINT** key to initialize the balance. The balance will automatically return to the weighing mode.

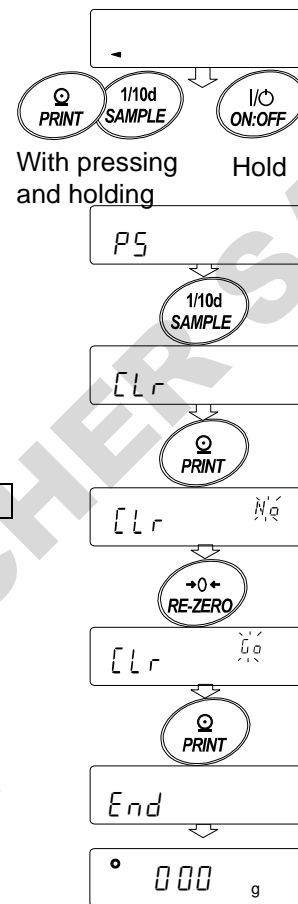







# 11.Function Table

The function table reads or rewrites the parameters that are stored in the balance. These parameters are maintained in non-volatile memory, even if the AC adapter is removed.

The function table menu consists of two layers. The first layer is the "Class" and the second layer is the "Item".

## 11-1 Setting The Function Table

### Display symbol and keys

	The symbol "O" shows effective parameter.
	When pressing and holding the key (for 2 seconds) in the weighing mode, the balance enters the function table mode. The key to select the class or item in the function table mode.
	The key to change the parameter.
	The key to change the parameter.
	When a class is displayed, moves to an item in the class. When an item is displayed, stores the new parameter and displays the next class.
	When an item is displayed, cancels the new parameter and displays the next class. When a class is displayed, exits the function table mode and returns to the weighing mode.

### Setting procedure

1. Press and hold the **SAMPLE** key (for 2 seconds) until **bASFnC** of the function table is displayed in the weighing mode, then release the key
2. Press the **SAMPLE** key to select a class.
3. Press the **PRINT** key to enter the class
4. Press the **SAMPLE** key to select a item.
5. Press the **RE-ZERO** key to select a parameter for the selected item.
6. To change another (multiple) item with the same class, repeat "4" and "5". To end the setting change of the same class, proceed to "7".
7. If storing parameters of the selected class, press the **PRINT** key.  
Then the next class is displayed.  
If canceling the current operation, press the **CAL** key. Then the next class is displayed.
8. When specifying parameters for another class, proceed to "2".  
When finishing the setting, press the **CAL** key twice to return to weighing mode.

## Setting Example

This example sets "Stores weighing data (dAtA 2)" for "Data memory (dAtA)" and "1 minute (int 5)" for "Interval time (int)".

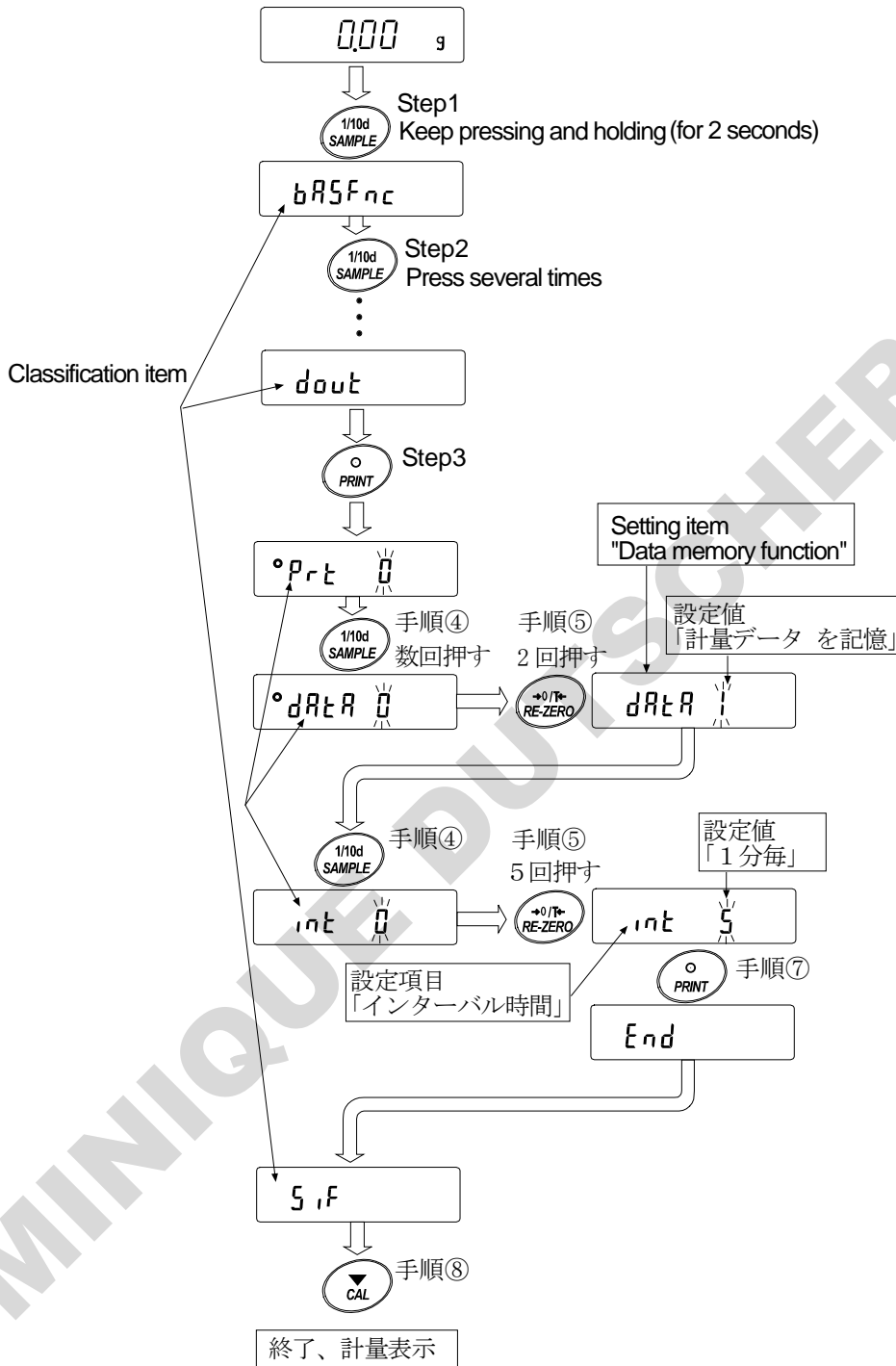



## 11-2 Details Of The Function Table

Class	Item	Parameter	Description		
bRSFnC【00】 Environment Display	Cond Condition	0	Fast response, sensitive value	Can be changed by response adjustment. With "Hold 1", sets the averaging time.	
		▪ 1			
		2	Slow response, stable value		
	St-b Stability band width	0	Stable when within ± 1 digit	The stabilization indicator illuminates with the display fluctuation within the range. With "Hold 1", sets the stabilization range.	
		▪ 1			
		2	Stable when within ± 3 digit		
	HoLd Hold function	▪ 0	OFF	Holds the display when stable in animal mode. With "Hold 1", [ANIMAL] turns on.	
		1	ON		
	trc Zero tracking	0	OFF	Keeps zero display by tracking zero drift.	
		▪ 1	Normal		
		2	Strong		
		3	Very strong		
	SPd Display refresh rate	▪ 0	5 times / second	Output frequency approx.5.2Hz	
		1	10 times / second	Output frequency approx.10.4Hz	
		2	20 times / second	Output frequency approx. 20.8Hz	
	Pnt Decimal point	▪ 0	Point (.)	Decimal point format	
		1	Comma (,)		
	P-on Auto display-ON	▪ 0	OFF	Turns on the weighing mode display when AC adapter is connected	
		1	ON		
P-off Auto display-OFF	▪ 0	OFF	Turns off the display after 10 minutes of inactivity.		
	1	ON			
rnG Minimum display	▪ 0	Display minimum display digit	Display at weighing start		
	1	Not display minimum display digit			
bEEP Buzzer	0	OFF			
	▪ 1	ON			
P-ZERO Stores tare value	▪ 0	OFF Zero indication at power on	ON Previous time weighing indication at power on		
	1				
dISP-LEd Backlight brightness	0~9	10%~100%	Factory setting 60%		
	▪ 5				
ISd Impact shock detection	0	OFF	Impact shock detection function		
	▪ 1	ON			
CL AdJ【01】 Clock		See "11-7 Clock and calendar Function"		Confirms and sets the time and date. The time and date are added to output data.	

▪ Factory setting

Note: "Digit" is a unit of minimum weighing value.

\* A number shown in 【 】 is class number and output as identification sign when outputting the function setting information at once.

Refer to "11-12 Outputting the function setting information".

Class	Item	Parameter	Description		
[P Fnc][02] Comparator	[P Comparator mode	0	No comparison		
		1	Comparison when stable value or overloaded		
		2	Continuous comparison		
	[P-t Number of comarator stages	0	3 stage comparator	HI, OK, LO	
		1	5 stage comparator	HH, HI, OK, LO, LL	
	[P-z Near zero	0	Also comare near zero		
		1	± 5 are not compared		
		2	± 10 are not compared		
		3	± 20 are not compared		
		4	± 50 are not compared		
		5	± 100 are not compared		
	[P-p Polarity	0	Plus only		
		1	Minus only		
		2	Bipolarity		
[P-R Comparator Result Adding	0	OFF	Comparator results can be added to outout data.		
	1	ON	Use this mode with A&D standard format (5 if tYPE 0).		
[P in Input method	0	Digital input, upper / lower limits		[P HH, [P HI, [P Lo and [P LL can be selected.	
	1	Weighing input, upper / lower limits			
	2	Digital input, reference value		[P rEF, [P LME and [P LME2 can be selected.	
	3	Weighing input, reference value			
[P Frd Flow measurement	0	Comparison by flow rate value			
	1	Comparison by weighing value			
[P-b Expanding Display Function	0	OFF	HI, OK and LO can be displayed largely at the weighing display when using comparator mode.		
	1	ON			
[P VALUE][03] Comparator value	[P HH Second upper limit	See 11-8 comparator Function"		Displayed only when [P in is set to 0.1.	
	[P HI Upper limit				
	[P Lo Lower limit				
	[P LL Second lower limit				
	[P rEF Reference value	See "11-8 comparator Function"		Displayed only when [P in is set to 2 or 3.	
	[P LME Tolerance value				
	[P LME2 Second tolerance value				

▪ Factory setting

Note: "Digit" is a unit of minimum weighing value.

Class	Item	Parameter	Description	
[P] bEEP【04】 Comparator buzzer	bEP HH HH buzzer	0	OFF	Displayed only when 5 step comparator is set.
		1	ON	
	bEP HI HI buzzer	0	OFF	
		1	ON	
	bEP OK OK buzzer	0	OFF	
1		ON		
bEP LO LO buzzer	0	OFF		
	1	ON		
bEP LL LL buzzer	0	OFF	Displayed only when 5 step comparator is set.	
	1	ON		
dout【05】 Data output	Prt Data output mode *1	0	Key mode	Accepts the [PRINT] key only when the display is stable.
		1	Auto print mode A (Reference=zero)	Outputs data when the weighing value stabilizes beyond the range from $RP-P$ to $RP-b$ from the zero point.
		2	Auto print mode B (Reference=last stable value)	Outputs data when the weighing value stabilizes beyond the range from $RP-P$ to $RP-b$ from last stable value.
		3	Stream mode	Outputs data at the specified display refresh rate.
		4	Key mode B (Immediately)	Accepts the [PRINT] key regardless of the display condition.
		5	Key mode C (When stable)	Accepts the [PRINT] key immediately when the display is stable, or waits for the display to be stable when not.
		6	Interval output mode	Outputs data for each time set by int .
	RP-P Auto print polarity	0	Plus only	Displayed value > Reference
		1	Minus only	Displayed value < Reference
		2	Bipolarity	Regardless of displayed value
	RP-b Auto print difference	0	10 digit	Difference between reference value and displayed value
		1	100 digit	
		2	1000 digit	

▪ Factory setting

Note: "Digit" is a unit of minimum weighing value.

For \*1, download "Communication manual" from our website (<http://www.aandd.jp/>) and refer to it.

Class	Item	Parameter	Description	
<i>dout</i> [05] Data output mode	<i>dAtA</i> Data memory	▪ 0	OFF	Refer to "13. Data Memory"
		1	Stores unit mass in counting mode	
		2	Stores the weighing data and calibration history	
		3	Stores comparator setting values	
		4	Stores tare values	
	<i>int</i> Interval time	0	Every measurement	Interval time in the interval memory mode when using <i>PrEtG</i> .
		▪ 1	2 seconds	
		2	5 seconds	
		3	10 seconds	
		4	30 seconds	
		5	1 minutes	
		6	2 minutes	
		7	5 minutes	
	<i>d-no</i> Data number	▪ 0	No output	Valid when data memory function is ON.
		1	Output	
<i>S-tD</i> Time/Date output	▪ 0	No output	Refer to "11-7 Clock And Calendar Function"	
	1	Time only		
	2	Date only		
	3	Time and date		
<i>S-id</i> ID number output	▪ 0	No output ID number		
	1	Output ID number		
<i>PUSE</i> Data output pause	▪ 0	OFF	Selects the data output interval.	
	1	ON open 1.6 seconds		
<i>At-F</i> Auto feed	▪ 0	OFF	Selects whether or not automatic feed is performed.	
	1	ON open 1 line		
<i>inFd</i> GLP output	▪ 0	OFF	Refer to "12-3 GLP Report"	
	1	ON		
	2	ON (output clock of external)		
<i>Ar-d</i> Zero after output	▪ 0	OFF	Function to apply re-zero after outputting data.	
	1	ON		
<i>UFC</i> UFC function	▪ 0	OFF	Refer to "Communication manual" on the A&D website.	
	1	ON		

▪ Factory setting

Note: "Digit" is a unit of minimum weighing value.

Class	Item	Parameter	Description	
SIF [06] Serial interface *1	Mode Access point	0	PC	All communication setting are possible. Only TYPE 0,1 can be selected.
		1	Printer	
		2	External indicator	
	bps Baud rate	0	600bps	
		1	1200bps	
		2	2400bps	
		3	4800bps	
		4	9600bps	
		5	19200bps	
	bitPr Data bit, parity bit	0	7 bit EVEN	
		1	7 bit ODD	
		2	8 bit NONE	
	CrLf Terminator	0	CR LF	CR: ASCII 0Dh code LF: ASCII 0Ah code
		1	CR	
	TYPE Data format	0	A&D standard format	Refer to "communication manual " on the A&D website.
1		DP format		
2		KF format		
3		MT format		
4		NU format		
5		CSV format		
6		NU2 format		
t-UP Command time out	0	No limited	Selects wait time during command reception	
	1	Limited for one second		
ErrCd AK, error code	0	OFF	AK: ASCII 06h code	
	1	ON		
USB [07] USB interface *1	UFnc USB Function mode	0	Quick USB	Refer to "communication manual " on the A&D website.
		1	Bidirectional USB virtual COM	
	U-UP USB data format	0	A&D standard format	
		1	NU format	
		2	CSV format	
	3	TAB format		
	4	NU2 format		

▪ Factory setting

Note: "Digit" is a unit of minimum weighing value.

Class	Item	Parameter	Description		
AP Fnc [10] Application function	APP Application mode	0	Normal weighing mode	Refer to "11-11.Description Of Application"	
		1	Capacity indicator		
		2	Statistical calculation mode		
		3	Flow measurement mode		
		4	Gross, Net, Tare mode		
	STAT Statistical function mode output items.	0	Number of data, sum		
		1	Number of data, sum, max, min, range(max-min), average		
		2	Number of data, sum, max, min, range(max-min), average, standard deviation, coefficient of variation		
		3	Number of data, sum, max, min, range(max-min), average, standard deviation, coefficient of variation, relative error		
	FRD Unit Flow rate unit	0	g / s (gram/second)	Refer to "15. Flow Measurement"	
		1	g / m (gram/minute)		
		2	g / h (gram/hour)		
		3	mL / s (milliliter/second)		
		4	mL / m (milliliter/minute)		
5		mL / h (milliliter/hour)			
CT AUTO Calculation time automatic setting	0	OFF			
	1	ON			
MW Fnc [11] Minimum Weighing Warning Function	MW-CP Minimum weighing comparison	0	No comparison Do not use MW Fnc		
		1	Comparison without near zero		
		2	Comparison including near zero		
	MW Minimum weighing value input	Refer to "17. Minimum Weighing Warning Function"			
Minout Minimum weight out	0	OFF		Refer to "17. Minimum Weighing Warning Function"	
	1	ON			
Unit [12] Unit	Refer to "5. Weighing Units"				
dS Fnc [13] Specific gravity measuring function	Ld in Liquid density input	0	Water temperature	Refer to "20. Density Measurement"	
		1	Liquid density		
	dS Specific gravity measuring mode	0	Density measurement of a soil		
		1	Density measurement of a liquid		
ID [15] ID number setting	Refer to "12-2. Setting The ID Number"				

▪ Factory setting

Note: "Digit" is a unit of minimum weighing value.

Class	Item	Parameter	Description	
PASSwd【16】 Password lock	LOCK Lock function	▪ 0	OFF	Refer to "21. Password Lock Function"
		1	ON (Limit weighing operation)	
		2	ON (Basic weighing is possible)	
	PASSNo. Password registration	ADMIN	Administrator password input	
		USER 01	USER 1 password input	
		USER 10	USER 10 password input	
*2 Auto CAL【17】 Auto calibration	[FnC Calibration mode	▪ 0	Setting temperature	
		1	Setting time	
		2	Interval time	
	[tIME 1 Setting time1	Refer to " 9-1 Automatic Self calibration For The GX-M Series "		
	[tIME 2 Setting time2			
[tIME 3 Setting time3				
[int Interval time				
[S in *2【18】 Correction of internal mass value.	Auto	Automatic input	Refer to "9-7 Correcting The Internal Mass Value Of The GX-M series (Auto)"	

\*2 is GX-M series only.

▪ Factory setting

Note: "Digit" is a unit of minimum weighing value.

## 11-3 Description Of The Class "Environment, Display"

### Condition ( $\text{Cond}$ )

- $\text{Cond } 0$  This parameter is for sensitive response to the fluctuation of a mass value. Used for powder target mass, weighing a very light sample or when quick response weighing is required. After setting, the balance displays **FAST**.
- $\text{Cond } 2$  This parameter is for stable weighing with slow response. Used to prevent a mass value from drifting due to vibration or drafts. After setting, the balance displays **SLOW**.

### Stability band width ( $\text{St-b}$ )

This item controls the width to regard a mass value as a stable value. When the fluctuation per second is less than the parameter, the balance displays the stabilization indicator and outputs or stores the data by function setting (*count, dRtR* etc.) The parameter influences the "Auto print mode". Also, the minimum display being displayed is 1 digit.

Ex. If 0.1 g display is selected by pressing the **SAMPLE** key on the GX-10002M, 0.1 g is 1 digit.

- $\text{St-b } 0$  This parameter is used for sensitive response of the stabilization indicator. Used for exact weighing.
- $\text{St-b } 2$  This parameter ignores slight fluctuations of a mass value. Used to prevent a mass value from drifting due to vibration or drafts

### Hold function ( $\text{Hold}$ ) (Animal weighing mode)

This function is used to weigh a moving object such as an animal. When the weighing data is over the weighing range from zero and the display fluctuation is within the stabilization range for a fixed period of averaging time, the processing indicator illuminates and the balance displays the average weight of the animal. When the animal or sample is removed from the weighing pan, the display returns to zero automatically. This function is available only when the hold function parameter is set to "I" (the animal mode indicator

**HOLD** illuminates) and any weighing unit other than the counting mode is selected. The stabilization range and averaging time are set in "Condition ( $\text{Cond}$ )" and "Stability band width ( $\text{St-b}$ )".

Weighing range		Averaging time		Stabilization range		
0.01g model	2.00g or more	$\text{Cond } 0$	2sec.(Efficiency priority)	$\text{St-b } 0$	Lesser	6.25%
0.1g model	20.0g or more	$\text{Cond } 1$	4sec.	$\text{St-b } 1$	↑	12.5%
		$\text{Cond } 2$	8sec.(Exact priority)	$\text{St-b } 2$	Greater	16.7%

\* Animal container kit (GXK-12) can be installed.

### Zero tracking ( $\text{trc}$ )

This function tracks zero point drift caused by changes in the environment and stabilizes the zero point. When the weighing data is only a few digits, turn the function off for accurate weighing.

- $\text{trc } 0$  The tracking function is not used. Used for weighing a very light sample.
- $\text{trc } 1$  The normal tracking function is used. ( $\pm 1$  digit / 1 second)
- $\text{trc } 2$  The strong tracking function is used. ( $\pm 1$  digit / 0.5 second)
- $\text{trc } 3$  The very strong tracking function is used. ( $\pm 2$  digit / 0.2 second)



### Display refresh rate ( $SP_d$ )

The periodic time to refresh the display. This parameter influences "Baud rate", "Data output pause" and the data output rate of "Stream mode".

### Decimal point ( $P_{nt}$ )

The decimal point format can be selected.

### Auto display-ON ( $P_{-on}$ )

When the AC adapter is plugged in, the display is automatically turned on without the  ON:OFF key operation, to display the weighing mode. Used when the balance is built into an automated system. Half an hour warm up is necessary for accurate weighing.

### Auto power-OFF ( $P_{-off}$ )

This is a function to turn off only the display automatically when there is no operation made for a certain amount of time (approximately 10 minutes) while the power is on.

### Minimum display ( $r_{nd}$ )

When weighing with rough precision, the minimum display can be turned off without key operation. This is useful when built into an automated system/

### Buzzer ( $bEEP$ )

Select ON/OFF for the built-in buzzer that sounds when a key is operated or the status changes.

### Tare value record ( $P_{-ZERO}$ )

After turning on the power supply, the display will not be automatically set to zero, and it will start from the previous weighing value. This is useful when a hopper, etc. is attached to the weighing pan and the power needs to be turned off while weighing discharge.

### Backlight brightness ( $d_{SP-LED}$ )

Select the brightness of the backlight of the LCD display.

### Impact shock detection ( $i_{sd}$ )

Select ON/OFF for the Impact shock detection.

## 11-4 Description Of The Data Output

Download "Communication manual" from our website (<http://www.aandd.jp/>) and refer to it.

## 11-5 Description Of The Data Format

Download "Communication manual" from our website (<http://www.aandd.jp/>) and refer to it.

## 11-6 Output Example Of The Data Format

Download "Communication manual" from our website (<http://www.aandd.jp/>) and refer to it.

## 11-7 Clock And Calendar Function

The balance is equipped with a clock and calendar function.

When the Clock and Calendar function (*clock, 5-td*) is set, the time and date are added to the output data.

Set or confirm the time and date as follows:

### Operation

1. Press and hold the **SAMPLE** key (for 2 seconds) until **bRSFnC** of the function table is displayed in the weighing mode, then release the key.
2. Press the **SAMPLE** key several times to display **CL Adj**.
3. Press the **PRINT** key.  
The balance enters the mode to confirm or set the time and date.

### Confirming the time

4. The current time is displayed with all the digits blinking.
  - When the time is not correct and is to be changed, press the **RE-ZERO** key and go to "5".
  - When the time is correct and the date is to be confirmed, press the **SAMPLE** key and go to "6".
  - When the time is correct and the date does not need to be confirmed, press the **CAL** key and go to "8".

### Setting the time

5. Set the time in 24-hour format using the following keys.
  - RE-ZERO** (+) key ..... To increase the value by one.
  - MODE** (-) key ..... To decrease the value by one.
  - SAMPLE** key ..... To select the digits to change the value.  
The selected digits blink.
  - PRINT** key ..... To store the new setting, display **End** and go to "6".
  - CAL** key ..... To cancel the new setting and go to "6".

### Confirming the date

6. The current date is displayed with all the digits blinking.
  - To change the display order of year (*y*), month (*m*) and day (*d*), press the **MODE** key. The date is output in the order as specified.
  - When the date is not correct and is to be changed, press the **RE-ZERO** key and go to "7".
  - When the date is correct and the operation is to be finished, press the **CAL** key and go to "8".
  - When the time is to be confirmed again, press the **SAMPLE** key and go back to "4".

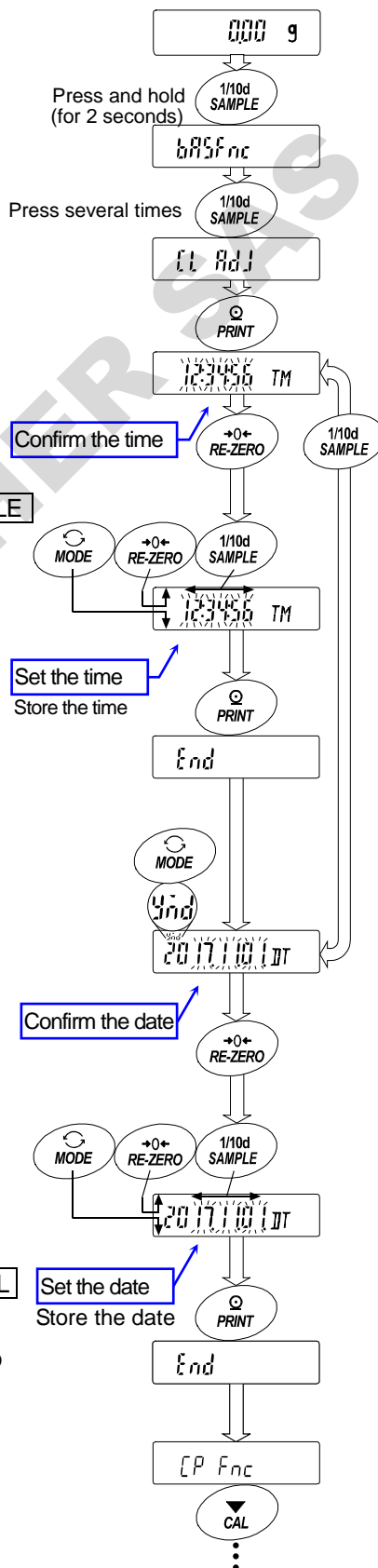

## Setting the date

7. Set the date using the following keys. (The year is set with the last 2 digits of the Christian era)

**RE-ZERO**(+)key ..... To increase the value by one.

**MODE**(-)key ..... To decrease the value by one.

**SAMPLE** key ..... To select the digits to change the value.

The selected digits blink.

**PRINT** key ..... To store the new setting, display **End** and go to "8".

**CAL** key ..... To cancel the new setting and go to "8".

## Quitting the operation

8. The balance displays the next menu (**EPFC**) of the function table. Press the **CAL** key to exit the clock and calendar function and return to the weighing mode.

**Note** Do not enter invalid values such as a non-existing date when setting the time and date.

When the clock backup battery has been depleted, the balance displays **rtc PF**. When a replacement of the battery is necessary, please contact your local A&D dealer. The dead battery only affects the clock and calendar function. Even so, the function works normally as long as the AC adapter is connected to the balance.

## 11-8 Comparator Function

The comparison of comparators can select 3-steps or 5-steps ( $[P Fnc]$ ,  $[P-t]$ ), and it is set to 3-steps at the factory setting.

When 3-step comparator is set, the results of the comparison are indicated by HI OK LO on the display.

When 5-step comparator is set, HH is indicated by HI blinking and LL by LO blinking.

By using GXM-04, it is possible to output the comparison result at the contact point.

There are three types of scope that can be selected as follows.

- No comparison
- Comparison when the weight data is stable or overloaded
- Continuous comparison

The conditions for comparing near zero are in six levels from "including near zero" to " $\pm 100$  digits". "Upper limit value and lower limit value" and "reference value and tolerance range" are the comparison standards.

There are "Digital input" and "Input by sample load" as input method for each value.

Refer to the function setting [P Fnc].

By setting the function setting [P bEEP], it is also possible to sound an internal buzzer depending on the result of the comparison.

### 3-step comparison result

Weighing value		3-step comparison - display			
Threshold value	Judgment formula	Judgment result	Lit display	Blinking display	Buzzer control
Upper limit	Upper limit value < Weighing value	HI	<span style="border: 1px solid black; padding: 2px;">HI</span>	/	bEEP HI
Lower limit	Lower limit value $\leq$ Weighing value $\leq$ Upper limit value	OK	<span style="border: 1px solid black; padding: 2px;">OK</span>	/	bEEP OK
	Weighing value < Lower limit value	LO	<span style="border: 1px solid black; padding: 2px;">LO</span>	/	bEEP LO

### 5-step comparison result

Weighing value		5-step comparison - display			
Threshold value	Judgment formula	Judgment result	Lit display	Blinking display	Buzzer control
Second upper limit	2nd Upper limit value < Weighing value	HH	/	<span style="border: 1px solid black; padding: 2px;">HI</span>	bEEP HH
Upper limit	Upper limit value < Weighing value $\leq$ 2nd Upper limit value	HI	<span style="border: 1px solid black; padding: 2px;">HI</span>	/	bEEP HI
Lower limit	Lower limit value $\leq$ Weighing value $\leq$ Upper limit value	OK	<span style="border: 1px solid black; padding: 2px;">OK</span>	/	bEEP OK
Second lower limit	2nd Lower limit value $\leq$ Weighing value < Lower limit value	LO	<span style="border: 1px solid black; padding: 2px;">LO</span>	/	bEEP LO
	Weighing value < 2nd Lower limit value	LL	/	<span style="border: 1px solid black; padding: 2px;">LO</span>	bEEP LL

#### Note

- The comparator function in the flow measurement mode ( $[PF3]$ ) is compared at the factory setting with the flow rate value. By setting  $[P-Frd]$  of the Function table  $[PFnc]$  to "1", it is also possible to compare with weight value (g unit).

### Selecting the comparator stage (3 stages/5 stages)

1. Press and hold the **SAMPLE** key (for 2 seconds) to display **bASFnC** of function settings.
2. Press the **SAMPLE** key several times to display **CPFnC**.
3. Press the **PRINT** key.
4. Press the **SAMPLE** key several time to display **CP<sup>2</sup>**.
5. Press the **RE-ZERO** key to select "0" of 3 stages or "1" of 5 stages.  
Press the **PRINT** key to confirm.
6. Press the **CAL** key to return to weighing mode.

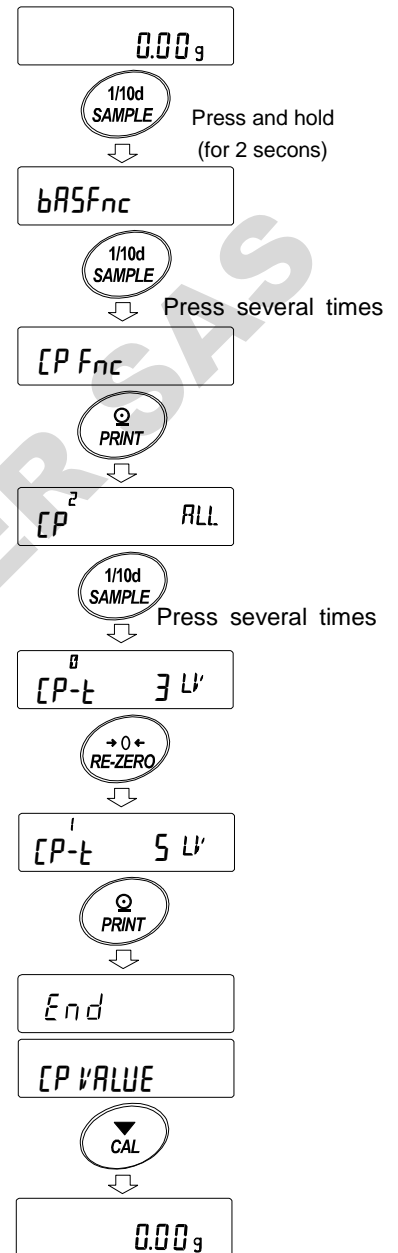

**Example1** (Always compare except "near zero"  $\pm 20$  digits and digitally input reference value and scope.)

**Selecting a comparator mode (Input scope, comparison criteria and value.)**

1. Press and hold the **SAMPLE** key (for 2 seconds) until **bASFnC** of the function table is displayed, then release the key.
2. Press the **SAMPLE** key several times to display **CP FnC**.
3. Press the **PRINT** key.
4. Press the **RE-ZERO** key several times to display **CP ALL** ("Z" always compare).
5. Press the **SAMPLE** key several times to display **CP-Z**.
6. Press the **RE-ZERO** key several times to display **CP-Z EX 20d** ("Z"  $\pm 20$  digit is not compared.)
7. Press the **SAMPLE** key several times to move to **CP in**.
8. Press the **RE-ZERO** key several times to display **CP in rFE DIG** ("Z" reference value is set. digital input)
9. Press the **PRINT** key to store the selected mode.

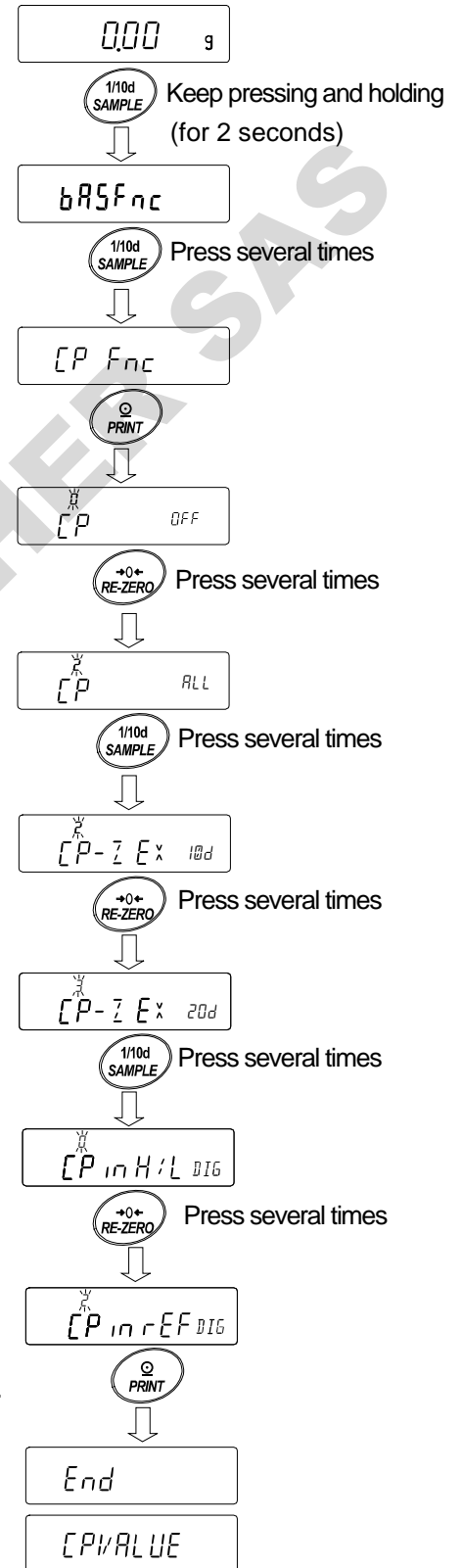

## Entering the values

10. With **[CP VALUE]** displayed, press the **[PRINT]** key.
11. Display **[CP rEF]** .
12. Press the **[PRINT]** key.
13. The current setting value is displayed with all of the digits blinking.
14. When the current setting is not to be changed, press the **[PRINT]** or **[CAL]** key to go to "15".

When the current setting is to be changed, press the **[RE-ZERO]** key and store the following keys.

- [SAMPLE]** key .... Select the digit to change the value.
- [RE-ZERO]** key... Change the value of the digit selected.
- [MODE]** key ..... Switch the polarity.
- [PRINT]** key ..... Store the new setting and go to "15".
- [CAL]** key ..... Cancel the new setting and go to "15".

15. When **[CP LME]** is displayed, pressing the **[PRINT]** key will display the currently set value.

If changing the setting value, it can be registered the tolerance value with the following keys.

For tolerance value, enter the value with the reference value set to 100%.

- [SAMPLE]** key ..... Move the blinking digit.
- [RE-ZERO]** (+)key ...Change the value of the blinking digit.
- [MODE]** (-)key ..... Change the value of the blinking digit.
- [PRINT]** key..... Register and go to "16"
- [CAL]** key..... Cancel and go to "16"

16. Press the **[CAL]** key twice to return to the weighing display.

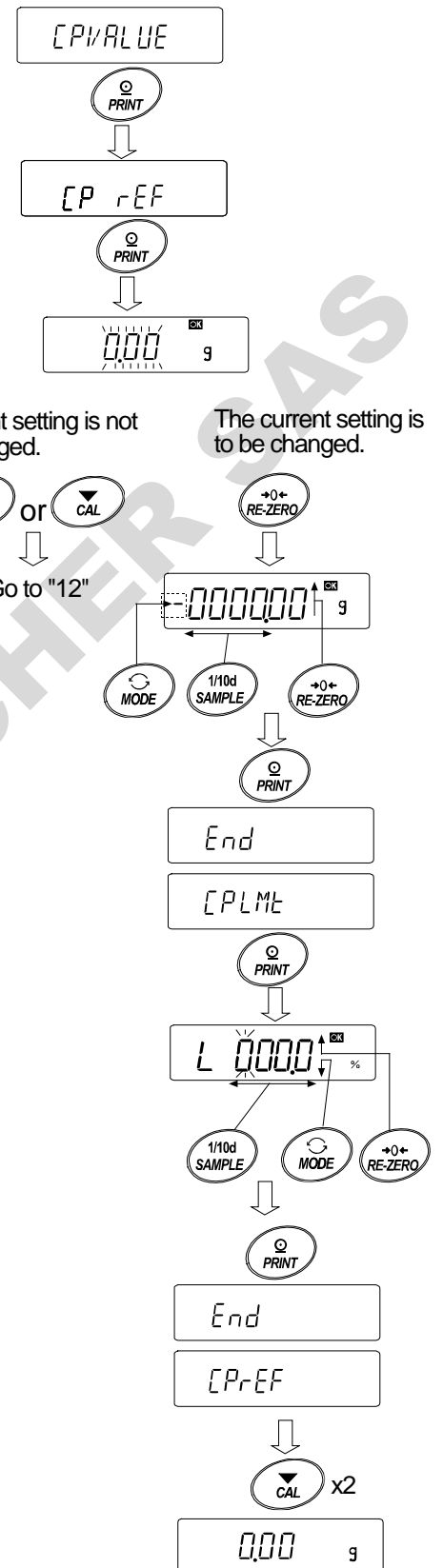

## Example 2

(Continuous comparison, including "near zero", reference value and tolerance value.)

### Selecting a comparator mode

1. Press and hold the **SAMPLE** (for 2 seconds) key until **bASFnC** of the function table is displayed, then release the key.
2. Press the **SAMPLE** key several times to display **[P Fnc]**.
3. Press the **PRINT** key.
4. Press the **RE-ZERO** key several times to **[P ]tRb** display (" | " compared when stable and over)
5. Press the **SAMPLE** key several times to display **[P-]**.
6. Press the **RE-ZERO** key several times to display **[P-] IN**. (" 0 " near zero is also compared.)
7. Press the **SAMPLE** key several times to display **[P in]**.
8. Press the **RE-ZERO** key several times to display **[P in H/L WT]**. (" | " upper-lower limit is set. Input by loaded.)
9. Press the **PRINT** key to store the new setting.

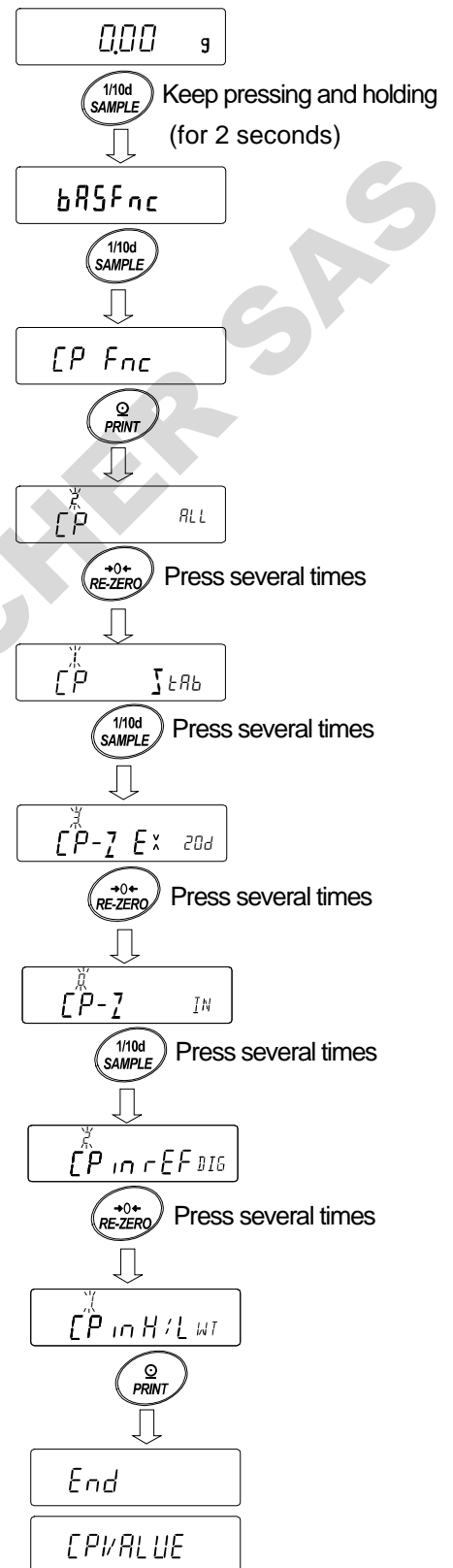



## Entering the reference and tolerance values

10. When **[P VALUE]** is displayed, press the **[PRINT]** key.  
**[P Hi]** will be displayed.
  11. When **[P Hi]** is displayed, press the **[PRINT]** key to check the currently set value (all blinking).  
Press the **[RE-ZERO]** key to enter the load input mode.
  12. Press the **[RE-ZERO]** key, **0.00g** is displayed. Place a sample of the weight of the upper limit on the balance and press the **[PRINT]** key. (Register the upper limit value.)
  13. When finished, **[P Lo]** is displayed. (Replace a sample of the weight of the upper limit from the balance.)
  14. When **[P Lo]** is displayed, press the **[PRINT]** key to check the currently set value (all blinking). Press the **[RE-ZERO]** key to enter the load input mode.
  15. Press the **[RE-ZERO]** key, **0.00g** is displayed.
  16. Place a sample of the weight of the lower limit on the balance and press the **[PRINT]** key. (Register the lower limit value.)
  17. When finished, **[P Hi]** is displayed. (Replace a sample of the weight of the lower limit from the balance.)
- Press the **[CAL]** key twice to return to the weighing display.

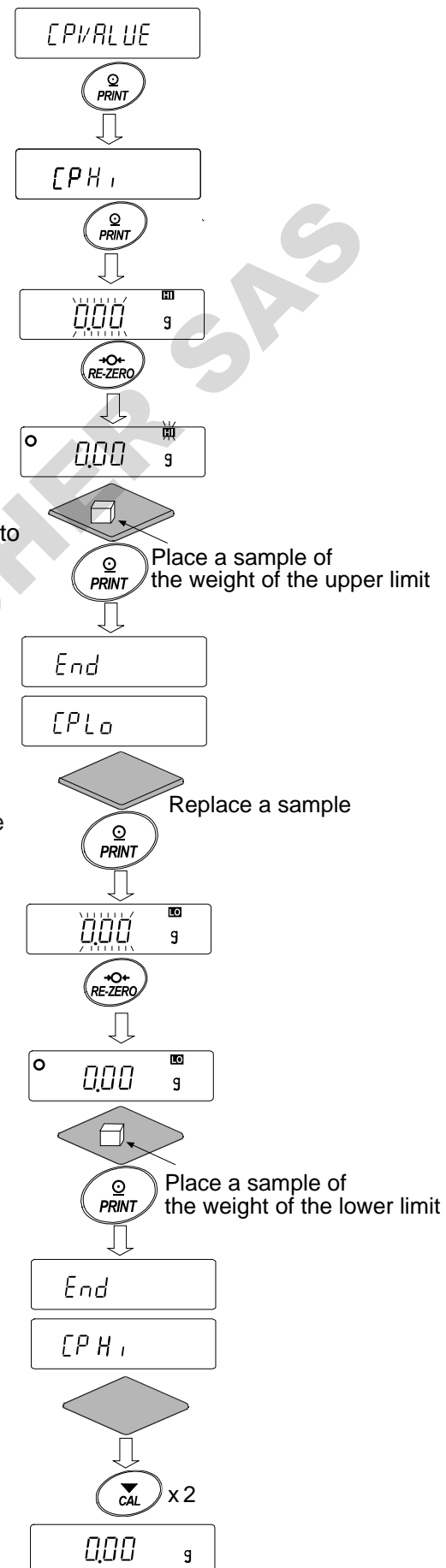

## Sound the built-in buzzer corresponding to the comparison result.

1 Press and hold the **[SAMPLE]** key (for 2 seconds) until **bRSFnc** of the function table is displayed.

2 Press the **[SAMPLE]** key several times to display **CPbEEP**.

3 Press the **[PRINT]** key.

4 Press the **[SAMPLE]** key to set the buzzer sound setting "ON/OFF" of the comparison result.

When 3-step comparator is set, the display can be selected

from the following 3 kinds **bEP H<sub>i</sub>**, **bEP oK**, **bEP L<sub>o</sub>**.

When 5-step comparator is set, the display can be selected from the following 5 kinds

**bEP HH**, **bEP H<sub>i</sub>**, **bEP oK**, **bEP L<sub>o</sub>**, **bEP LL**.

**[SAMPLE]** key..... Select the comparison result.

**[RE-ZERO]** key..... Set the buzzer sound setting of the comparison result "ON/OFF"

**[PRINT]** key.....Store the setting.

**[CAL]** key..... Cancel and return to the weighing display.

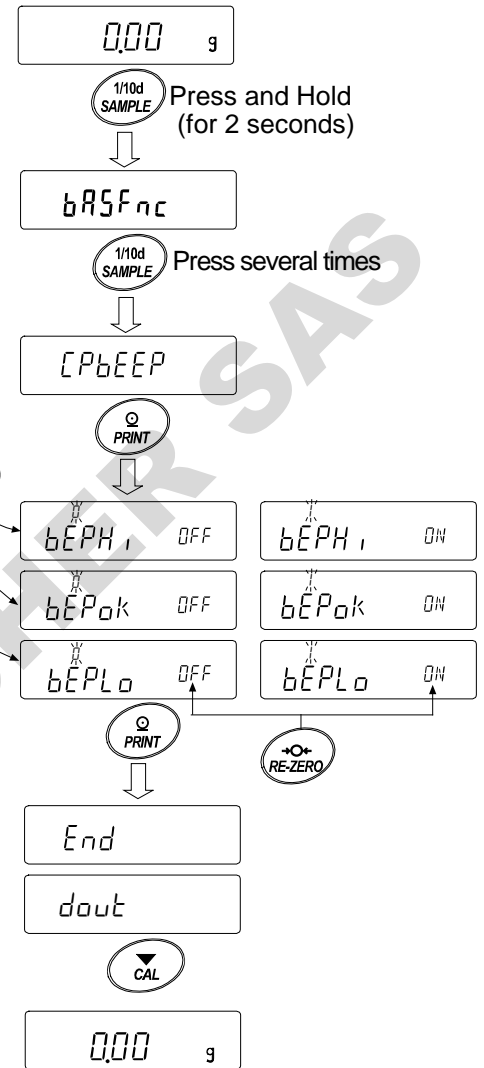

## 11-9 Adding the Comparison Results

By setting the "Comparison results (CP-R)" of the function table to "I", the comparison results can be added to the data output using the RS-232C serial interface or USB interface. Use A&D standard format (TYPE 0).

The comparison results are added after the header in A&D standard format as below.

S	T	,	O	K	,	+	0	1	2	3	4	5	.	6	┌	┌	g	C	R	L	F
Header			Data												Unit		Terminator				
Comparison result																					
H	I	When the comparison result is HI																			
O	K	When the comparison result is OK																			
L	O	When the comparison result is LO																			
-	-	Not applicable																			

## 11-10 Main Display Comparison Function

The main display comparison function displays the comparison results in a magnified way, on the main portion of the display in place of the weight value.

Selecting a unit

Step 1 Press the **MODE** key to select a unit to be used for comparison.

**Note** While the main display comparison function is in use, unit selection using the **MODE** key is not available.

Setting the function table

Step 2 Press and hold the **SAMPLE** key (for 2 seconds) until **bRSFnC** of the function table is displayed, then release the key.

Step 3 Press the **SAMPLE** key several times to display **[P Fnc]**.

Step 4 Press the **PRINT** key.

Step 5 Press the **SAMPLE** key several times to display **[P-b 0]**.

Step 6 Press the **RE-ZERO** key to display **[P-b 1]**.

**Note** To disable the main display comparison function, set the "Main display comparison ([P-b])" parameter to "0".

Step 7 Press the **PRINT** key to store the setting.

Step 8 Press the **CAL** key to return to the weighing mode.

Setting the comparator values

Setting the comparator values as described in the previous section.

This example uses **[P 3]** (Continuous comparison, excluding "near zero").

Using the main display comparison function

Step 1 Press the **RE-ZERO** key to set the display to zero.

Step 2 Place a sample on the pan. The balance performs a comparison using the specified comparison values and displays the comparison results, **HI**, **OK** or **LO**.

Step 3 Each time the **MODE** key is pressed, the balance switches between the standard display and the main display comparison. Note that "0" appears for **OK**.

### Notes

- While the main display comparison function is in use, the processing indicator  illuminates as shown in the illustration.
- If the comparison is not performed, for example, because the weight value is near zero or unstable, the balance displays the weight value even when the main display comparison function is used.
- Even while the main display comparison function is in use, the balance re-zeroing and data output are possible.
- Only the unit selected before this function can be used.
- While the main display comparison function is in use, the data memory function is not available.
- To disable the main display comparison function, set the "Main display comparison ([P-b])" parameter to "0".

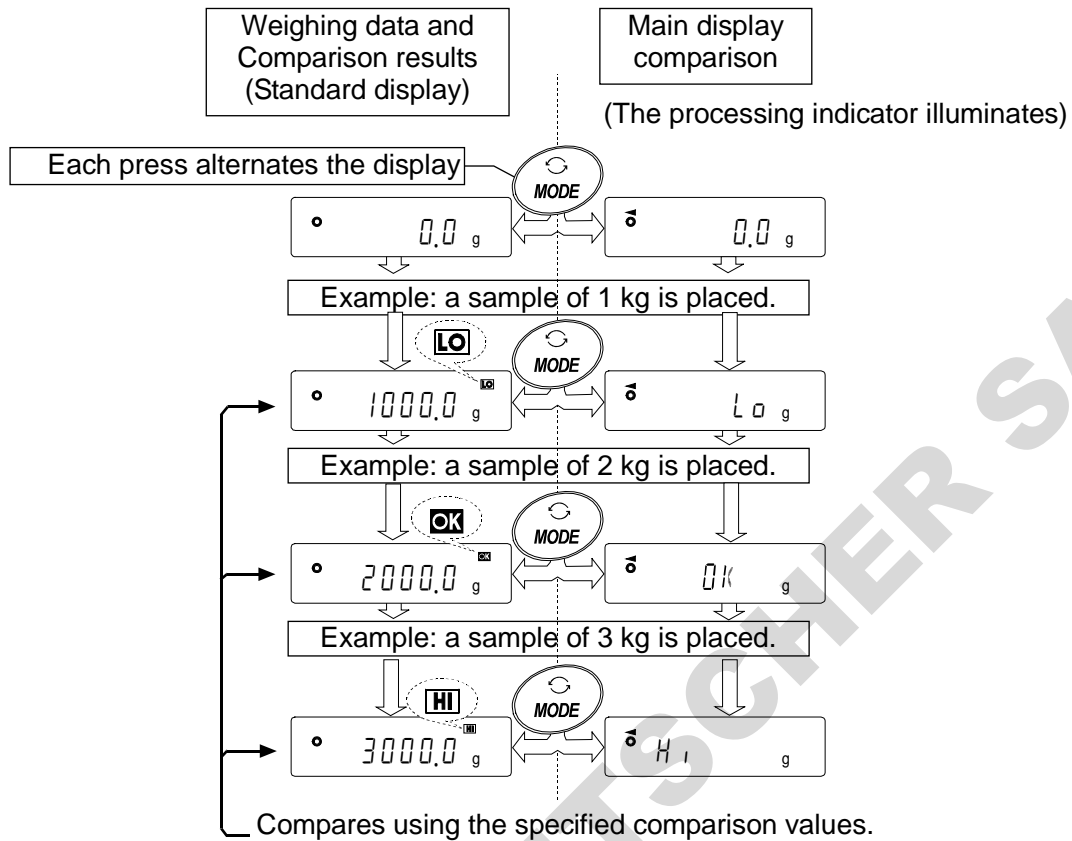

## 11-11 Description Of Application

### Description of the normal weighing mode (APF 0).

The normal weighing mode of the factory setting.

### Description of the weighing indicator mode (APF 1).

The weighing indicator displays the relation between load and weighing capacity in percent in normal weighing.

(Zero 0%, weighing capacity 100%)

**Note:**

- It can not used with the settings "dARA 1 or dARA 2" that use the data memory function (dARA).

### Description of the statistical calculation mode (APF 2).

This is a function to statistically calculate the weighing value and to display and output the result.

Refer to "14.Statistical Calculation Mode " .

### Description of the flow measurement mode ( RPF 3 ).

It is a function to calculate the flow measurement .

Refer to "15.Flow Measurement " .

### Description of the gross net tare mode ( RPF 4 ).

This is a function to operate the zero setting and taring separately and to output the data of Gross (total amount), Net (net amount) and Tare (tare quantity).

Refer to "16.Gross Net Tare Function".

## 11-12 Outputting the function setting information

Function setting can set the balance to appropriate operations for your needs.

The function table menu consists of two layers. The first layer is the "Class" and the second layer is the "Item".

By performing the following procedure, the function setting status can be output at once, so settings of balance being used can be recorded.

### Outputting the function setting information at once

1. Press and hold the **SAMPLE** key (for 2 seconds) in weighing mode
2. **bR5Fnc** is displayed.
3. Press and hold the **PRINT** key (for 2 seconds) to display **-L,5t-**. A current function setting information is output at once.

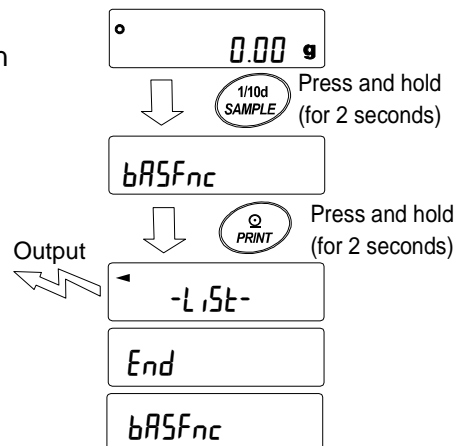

**【Output example】**

```

      A & D
MODEL GX-10202M ← Model name
S/N 123456789 ← Serial number
ID LAB-0123 ← ID
DATE 2019/01/22 ← Date
TIME 16:29:35 ← Time } Output a data and time for the balance
    
```

-----  
Function Table  
-----

```

00,Cond ,1
00,St-b ,1
00,HoLd ,0
00,trc ,1
00,SPd ,0
00,Pnt ,0
00,P-on ,0
00,P-oFF ,0
00,rnG ,0
00,bEEP ,0
00,P-Zero ,0
00,diSP-LEd ,5
00,LV-LEd ,0
.....
02,CP-Z ,2
02,CP-P ,2
02,CPin ,0
10,Frd Unit,0
10,Ct AUto ,0
-----
11,MW-CP ,0
11,MW ,001.0000 g
11,MW-t ,0
11,Min out ,1
-----
13,Ldin ,0
13,dS ,0
-----
16,LocK ,0
-----
17,CFnc ,0
17,Cint ,0
-----
END
    
```

(a) Class (2 characters)  
 (b) Item (8 characters)  
 (c) Parameter (1 character) or (12 characters)  
 \* Each one is divided using comma.  
 \* Refer to “11-2 Details Of The Function Table” in “11. Function Table” for details of class, item and parameter.

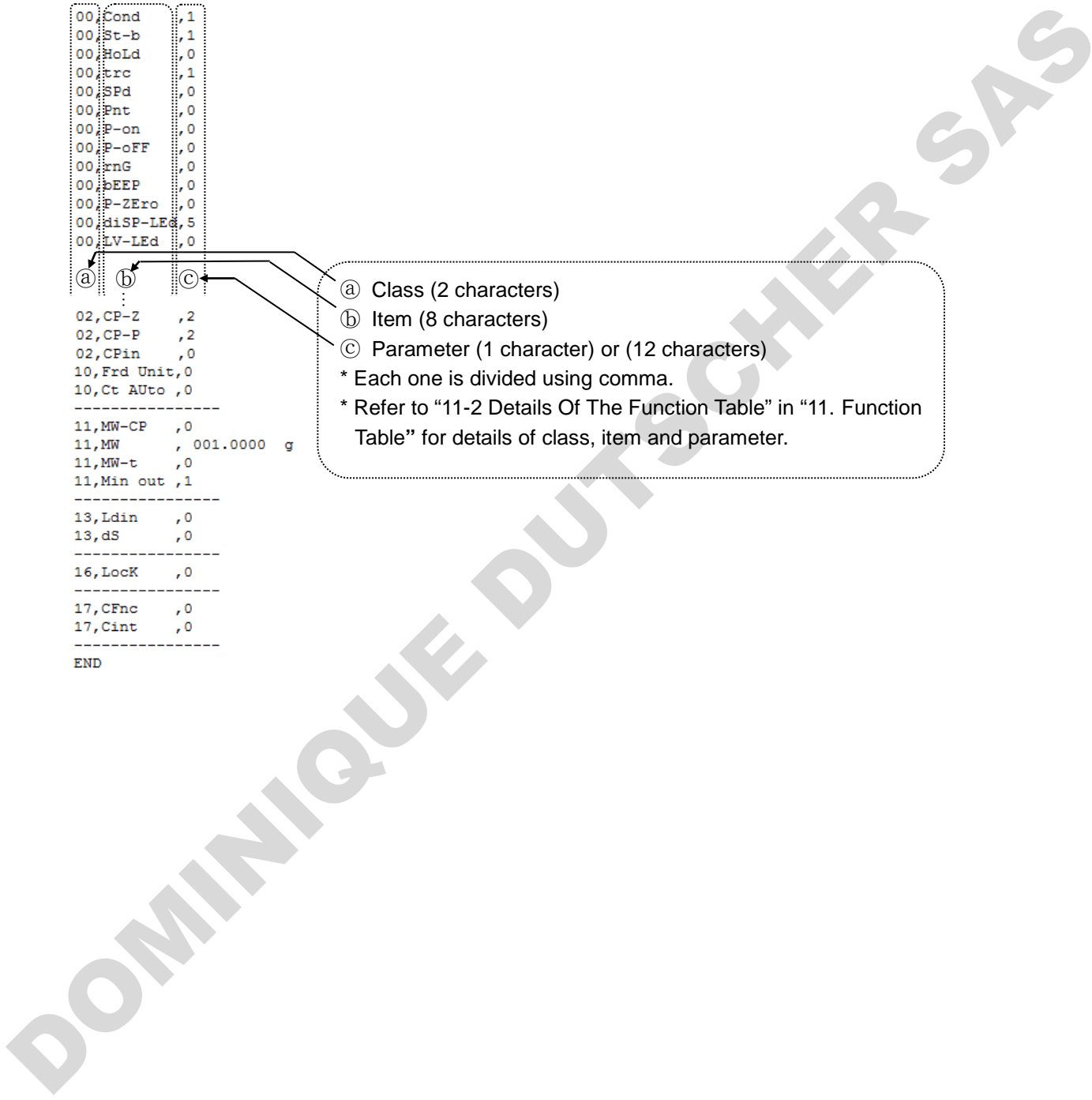

## **Use example 1 Outputting the function setting information to a printer**

Use AD-8126 Mini printer or AD-8127 Multi printer.

1. Connect the printer to the balance.

When using AD-8127, set the print mode to "DUMP".

Refer to instruction manual of the printer for details of the settings or print mode.

Refer to "Communication manual" on A&D web site (<http://www.aandd.jp/>) for details of the connection method between the balance and printer

2. Confirm that the communication can be made between the balance and printer and output an information using "Outputting the function setting information at once" described on previous page.

## **Use example 2 Outputting the function setting information to a PC**

Refer to "Communication manual" and "WinCT manual" on A&D web site (<http://www.aandd.jp/>) for details of the USB setting or WinCT.

1. Connect between the PC and balance using the provided USB cable or sold separately RS-232C cable.

\* Use the USB at virtual COM mode.

It cannot be output using quick USB.

2. Install the WinCT to a PC to be used.

Download WinCT software from A&D web site (<http://www.aandd.jp/>).

3. Start up RSCom and match communication settings such as COM port or baud rate to settings of the balance.

Press the [Start] button to enable the communication.

4. Confirm that the communication can be made between the balance and PC and output an information using "Outputting the function setting information at once" described on previous page.

# 12.ID Number And GLP Report

## 12-1 Main Objective

- The ID number is used to identify the balance when Good Laboratory Practice (GLP) or Good Manufacturing Practice (GMP) is used.
- The data output compatible with "GLP/GMP" can be output to a personal computer or printer using the RS-232C serial interface.
- The GLP / GMP compliant report includes the balance manufacturer, model, serial number, ID number, date, time and space for signature. It includes the results and using mass for calibration or calibration test data.
- The balance can output the following reports for GLP/ GMP.
  - "Calibration report" of the calibration, using the internal mass (Calibration due to changes in temperature and one-touch calibration.)
  - "Calibration report" of the calibration, using an external weight.
  - "Calibration test report" of the calibration test, using an external weight.
  - "Title block" and "End block" for the weighing data.
- Calibration and calibration test data can be stored in memory to output several reports at the same time. Refer to "13. Data Memory" for details.
- The ID number is used to identify the balance when the balance is used for maintenance management.
- The ID number is maintained in non-volatile memory even if the AC adapter is removed.
- For details on confirming and setting the time and date. Refer to "11-7. Clock and Calendar Function".
- It is also possible to output the clock data of an external device (such as a printer) without outputting data of the clock built in to the balance.

## 12-2 Setting The ID Number

1. Press and hold the **SAMPLE** key (for 2 seconds) until **bASFnC** of the function table is displayed, then release the key.
2. Press the **SAMPLE** key several times to display **id**.
3. Press the **PRINT** key. Set the ID number using the following keys.
  - SAMPLE** key ..... To select the digit to change the value.
  - RE-ZERO** key, **MODE** key .....To set the character of the digit selected.

Refer to the display character set shown below.

  - PRINT** key ..... To store the new ID number and display **PASSwd**.
  - CAL** key .....To cancel the new ID number and display **PASSwd**.
4. With **PASSwd** displayed, press the **CAL** key to return to the weighing mode.

**Note** The display segment of the balance is divided into 4types.  
For each segment display, refer to the "Display correspondence table" in the next page.

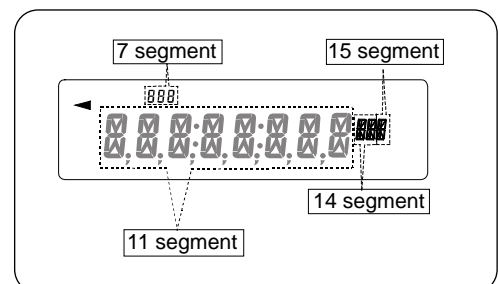



## Display correspondence table

### 11 Segment

0	1	2	3	4	5	6	7	8	9	-	□	A	B	C	D	E	F	G	H	I	J	K	L	M	N	O	P	Q	R	S	T	U	V	W	X	Y	Z
0	1	2	3	4	5	6	7	8	9	-	□	A	B	C	D	E	F	G	H	I	J	K	L	M	N	O	P	Q	R	S	T	U	V	W	X	Y	Z

↳ Space

### 7 Segment

0	1	2	3	4	5	6	7	8	9	-	□	A	B	C	D	E	F	G	H	I	J	K	L	M	N	O	P	Q	R	S	T	U	V	W	X	Y	Z
0	1	2	3	4	5	6	7	8	9	-	□	A	B	C	D	E	F	G	H	I	J	K	L	M	N	O	P	Q	R	S	T	U	V	W	X	Y	Z

↳ Space

### 14 Segment

0	1	2	3	4	5	6	7	8	9	-	□	A	B	C	D	E	F	G	H	I	J	K	L	M	N	O	P	Q	R	S	T	U	V	W	X	Y	Z
0	1	2	3	4	5	6	7	8	9	-	□	A	B	C	D	E	F	G	H	I	J	K	L	M	N	O	P	Q	R	S	T	U	V	W	X	Y	Z

↳ Space

### 15 Segment

0	1	2	3	4	5	6	7	8	9	-	□	A	B	C	D	E	F	G	H	I	J	K	L	M	N	O	P	Q	R	S	T	U	V	W	X	Y	Z
0	1	2	3	4	5	6	7	8	9	-	□	A	B	C	D	E	F	G	H	I	J	K	L	M	N	O	P	Q	R	S	T	U	V	W	X	Y	Z

↳ Space

## 12-3 GLP Report

Set the function setting to "inF0 1" (use data of clock built in to the balance) or "inF0 2" (use clock data of external equipment) to output the GLP / GMP data with a AD-8126 (mini printer), AD-8127 (multi printer) or personal computer.

### Note

- In case of outputting clock data built in the balance (inF0 1), if the time and date are not correct, set the correct time and date in "Clock ( [LRdU] )" of the function table.

### Calibration report using the internal mass

This is the GLP report when the balance is calibrated using the internal mass.

Output the clock data of built in balance ( inF0 1)

Printer format (AD-8127)

```

                A & D
MODEL   GX-10202M
S/N    123456789
ID     LAB-0123
DATE   2017/12/31
TIME   12:34:56
CALIBRATED<INT.>
REMARKS

SIGNATURE

-----

```

PC format (RsCom)

```

                A-&-D<TERM>
MODEL_  GX-10202M<TERM>
S/N_   123456789<TERM>
ID_    LAB-0123<TERM>
DATE_  2017/12/31<TERM>
TIME_  12:34:56<TERM>
CALIBRATED (INT.)<TERM>
REMARKS<TERM>
<TERM>
<TERM>
SIGNATURE<TERM>
<TERM>
<TERM>
-----<TERM>
<TERM>
<TERM>

```

— Space, ASCII 20h.  
 <TERM> Terminator, CR LF or CR  
 CR Carriage return, ASCII 0Dh.  
 LF Line feed, ASCII 0Ah.

## Output the clock data of external device (i7F0 2).

By setting the function table "i7F0 2" for outputting data such as GLP/GMP, the clock data of the external device such as PC or printer can be used without using the clock data of the balance.

### Note

- Clock data output from external device is for devices that have a clock function and can receive date and time data by receiving <ETC>D, <ETC>T.(Ex. AD-8127 multi printer, RsCom winCT etc.)
- When saving the calibration history of the data memory function, the built in clock data is saved even if it is set to "i7F0 2"

Printer format (AD-8127)

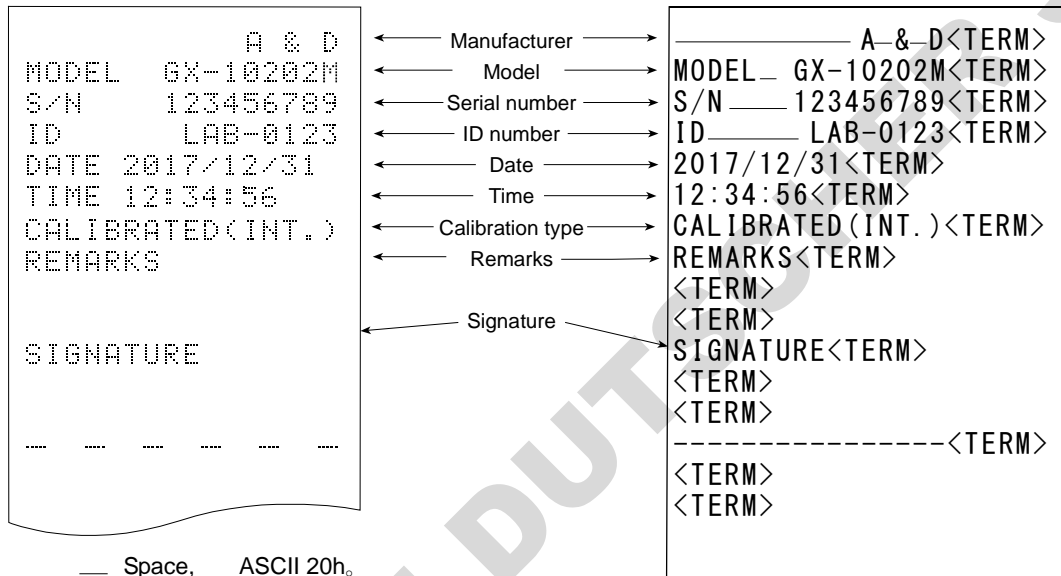

— Space, ASCII 20h.  
 <TERM>Terminator, CR LF or CR  
 CR Carriage return,ASCII 0Dh.  
 LF Line feed, ASCII 0Ah.

## Calibration report using an external weight

This is the GLP report when the balance is calibrated using the external weight.

Setting of *info 1*

Printer format (AD-8127)

```

      A & D
MODEL  GX-10202M
S/N    123456789
ID     LAB-0123
DATE   2017/12/31
TIME   12:34:56
CALIBRATED<EXT.>
CAL.WEIGHT
      +10000.00 g
REMARKS

SIGNATURE
-----
  
```

← Manufacturer →  
 ← Model →  
 ← Serial number →  
 ← ID number →  
 ← Date →  
 ← Time →  
 ← Calibration type →  
 ← Calibration weight →  
 ← Remarks →  
 ← Signature →

Setting of *info 1*

PC format (RsCom)

```

      A & D <TERM>
MODEL__GX-10202M <TERM>
S/N___123456789 <TERM>
ID____LAB-0123 <TERM>
DATE__2017/12/31 <TERM>
TIME___12:34:56 <TERM>
CALIBRATED (EXT.) <TERM>
CAL.WEIGHT <TERM>
_____+10000.00 __g <TERM>
REMARKS <TERM>
<TERM>
<TERM>
SIGNATURE <TERM>
<TERM>
<TERM>
-----<TERM>
<TERM>
<TERM>
  
```

— Space, ASCII 20h  
 <TERM>Terminator, CR LF or CR\*  
 CR Carriage return,ASCII 0Dh\*  
 LF Line feed, ASCII 0Ah\*

## Calibration test report using an external weight

This is the GLP report when checking the weighing accuracy of the balance with the external weight.

(Adjustment is not performed)

Setting of *info 1*

Printer format (AD-8127)

```

      A & D
MODEL  GX-10202M
S/N    123456789
ID     LAB-0123
DATE   2017/12/31
TIME   12:34:56
CAL.TEST<EXT.>
ACTUAL
      0.00 g
      +9999.95 g
TARGET
      +10000.00 g
REMARKS

SIGNATURE
-----
  
```

← Manufacture →  
 ← Model →  
 ← Serial number →  
 ← ID number →  
 ← Date →  
 ← Time →  
 ← Calibration test →  
 ← Zero point value →  
 ← Target weight value →  
 ← Target weight →  
 ← Remarks →  
 ← Signature →

Setting of *info 1*

PC format (RsCom)

```

      A & D <TERM>
MODEL__GX-10202M <TERM>
S/N___123456789 <TERM>
ID____LAB-0123 <TERM>
DATE__2017/12/31 <TERM>
TIME___12:34:56 <TERM>
CAL. TEST (EXT.) <TERM>
ACTUAL <TERM>
_____+0.00 __g <TERM>
_____+9999.95 __g <TERM>
TARGET <TERM>
_____+10000.00 __g <TERM>
REMARKS <TERM>
<TERM>
<TERM>
SIGNATURE <TERM>
<TERM>
<TERM>
  
```

— Space, ASCII 20h  
 <TERM>Terminator, CR\*LF or CR  
 CR Carriage return, ASCII 0Dh  
 LF Line feed, ASCII 0Ah

## Heading and ending output

### Application / Operation

As a method of managing weighing values, add "Heading" and "End" parts before and after the weighing value.

By pressing and holding the **PRINT** key (for 2 seconds), "Heading" and "End" are output in turn.

### Note

If the data memory function is used (except when *DATA 0*), heading and end cannot be output.

## Key output method

1. While displaying the weighing value, hold down the **PRINT** key (for 2 seconds) and display **START** to output "Heading".
2. Output the weighing value. The output method depends on the setting of the data output mode.
3. Press and hold the **PRINT** key (for 2 seconds) to display **END**, "End" is output.

Setting of *info 1*

Printer format (AD-8127)

(Internal setting *TYPE 1*)

```

                A & D
MODEL   GX-10202M
S/N     123456789
ID      LAB-0123
DATE    2017/12/31
START
TIME    12:34:56

WT      +1234.56 g
WT      +1234.61 g
WT      +1234.62 g
WT      +1234.63 g
  
```

```

WT      +1234.61 g
WT      +1234.53 g
WT      +1234.71 g
WT      +1234.64 g
  
```

```

END
TIME    12:45:56
REMARKS
  
```

SIGNATURE

-----

Setting of *info 1*

PC format (RsCom)

(Internal setting *TYPE 1*)

```

                A & D<TERM>
MODEL  GX-10202M<TERM>
S/N    123456789<TERM>
ID     LAB-0123<TERM>
DATE   2017/12/31<TERM>
START<TERM>
TIME   12:34:56<TERM>
<TERM>

WT  +1234.56 g<TERM>
WT  +1234.61 g<TERM>
WT  +1234.62 g<TERM>
  
```

```

WT  +1234.51 g<TERM>
WT  +1234.53 g<TERM>
WT  +1234.71 g<TERM>
WT  +1234.64 g<TERM>
  
```

```

<TERM>
END<TERM>
TIME 12:45:56<TERM>
  
```

```

REMARKS<TERM>
<TERM>
<TERM>
SIGNATURE<TERM>
<TERM>
<TERM>
  
```

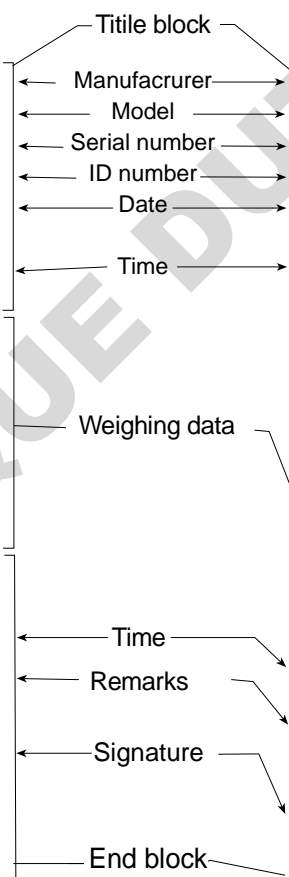

\_\_\_ Space, ASCII 20h

<TERM> terminator, CR LF or CR

CR Carriage return, ASCII 0Dh

LF Line feed, ASCII 0Ah

# 13. Data Memory

Data memory is a function to store weighing data and calibration data in memory. The data stored in memory are available for outputting at one time to a printer or personal computer.

The following five types of data can be stored.

Unit mass (Counting mode)	Up to 50 sets
Weighing value	Up to 200 sets
Calibration report Internal calibration External calibration Calibration test report Internal test calibration External test calibration	Last 50 sets
Comparator setting values Upper limit value/lower limit value only	Up to 20 sets
Tare value	Up to 20 sets

## 13-1 Data Memory For Weighing Data

### Features

- It is not necessary to connect the printer or personal computer to the balance continually, because the balance stores the weighing data in memory.
- By storing the weighing value in the balance, weighing operation can be performed without occupying the printer or PC for a long time.
- The data in memory can be displayed on the balance for confirmation.
- Data (ID number, data number, time and date) to be added to the output data can be selected in the function setting.
- Up to 200 sets of weighing data including time and date can be stored in memory of the balance.  
\* For the unit mass storage method, refer to "6-2 Counting Mode(PCS)".

### Storing the weighing data and calibration history

#### Note

1. Set the "Data memory (dAtA)" parameter to " dAtA 2". Refer to "11. Function Table".
2. Set the "Time/Date output (S-t-d)" parameter about whether or not to add time and date.
3. The storing mode depends on the "Data output mode (Pr-t)" parameter setting.  
When set to Pr-t 3 (stream mode), data may not be stored correctly.

\* It is also possible to change the time / date setting after storing the weighing value.

## Enabling data memory function

1. Press and hold the **SAMPLE** key (for 2 seconds) until **bRSFnc** of the function table is displayed.
2. Press the **SAMPLE** key several times to display **dout**.
3. Press the **PRINT** key.
4. Press the **SAMPLE** key several times to display **dAtA**.
5. Press the **RE-ZERO** key to display **dAtA We'CAL**.
6. Press the **PRINT** key to store the setting.
7. Press the **CAL** key to return to the weighing mode.

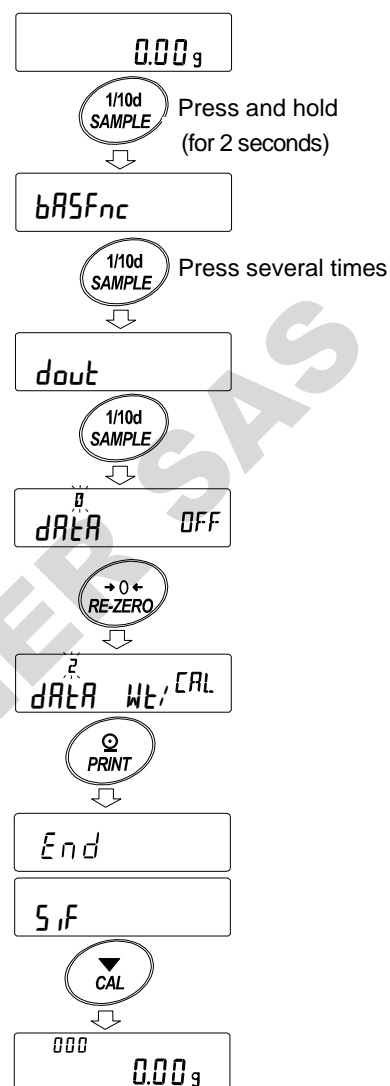

## Display and symbol

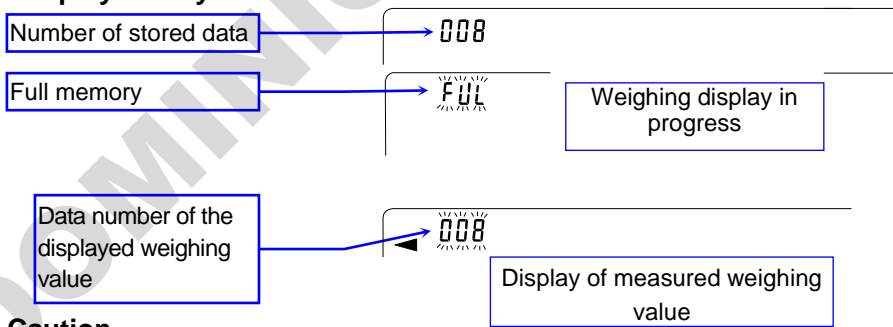

When the volume of measured values stored reaches its maximum, **FUL** ↔ **dAtA** blink in turn.

## Caution

- When weighing data is being stored in memory, the data is output simultaneously using RS-232C interface or USB.
- "FUL" indicates that memory is full or the memory capacity has been reached. More data cannot be stored unless the memory data is deleted.
- Automatic self calibration can not be used while the interval memory mode is active.
- Statistic calculation function can not be used when the data memory function is active.

## Setting the function table

Parameter settings for each output mode are as follows:

Mode \ Item	Data output mode	Auto print polarity, difference	Data memory function	Interval time
Key mode	<i>Pr t 0</i>	Not used	<i>dA t A 2</i>	Not used
Auto print mode A	<i>Pr t 1</i>	<i>AP-A 0 ~ 2</i>	<i>dA t A 2</i>	
Auto print mode B	<i>Pr t 2</i>	<i>AP-b 0 ~ 2</i>	<i>dA t A 2</i>	
Key mode B (immediate)	<i>Pr t 4</i>	Not used	<i>dA t A 2</i>	
Key mode C (stable)	<i>Pr t 5</i>		<i>dA t A 2</i>	
Interval output mode	<i>Pr t 6</i>		<i>dA t A 2</i>	

Parameter settings for Data number, ID number, Time and Date

Data number	No	<i>d-no "0"</i>	Time and date	No	<i>S-t d 0</i>	—
	Yes	<i>d-no "1"</i>		Time only	<i>S-t d 1</i>	Up to 200 pieces
ID number	No	<i>S-id "0"</i>		Date only	<i>S-t d 2</i>	
	Yes	<i>S-id "1"</i>		Both	<i>S-t d 3</i>	

## Recalling the memory data

Confirm that the "Data memory (*dA t A*)" parameter is set to "*dA t A 2*".

- Press and hold the **PRINT** key (for 2 seconds) until

**RECALL** is displayed, then release the key.

The type of data appears in the upper left of the display as shown to the right "-d- or d-t".

- Press the **PRINT** key to enter the memory recall mode.

Recall the data in memory using the following keys.

**RE-ZERO** key.....To proceed to the next data set.

**MODE** key .....To go back to the previous data set.

**PRINT** key .....To transmit the current data using the RS-232C or USB.

**CAL** key .....To exit the memory recall mode.

- Press the **CAL** key to return to the weighing mode.

\* It is also possible to change the time / date output setting after storing the weighing value.

Left of the display

-d-

When setting without clock / date  
or

d-t

When setting with clock / date



## Transmitting all memory data at one time

Confirm that the "Serial interface (S rF)" parameters are set properly.  
Refer to "10. Function Table" and "Communication Manual " on the A&D website.

1. Press and hold the **PRINT** key (for 2 seconds) until **RECALL** is displayed, then release the key.
2. Press the **SAMPLE** key to display **out**.
3. Press the **PRINT** key to display **out** with "No" blinking.
4. Press the **RE-ZERO** key to display **out** with "ERR" blinking.
5. Press the **PRINT** key to transmit all data using the RS-232C , USB.
6. The balance displays **CLEAR** when all data is transmitted.  
Press the **CAL** key to return to the weighing mode.

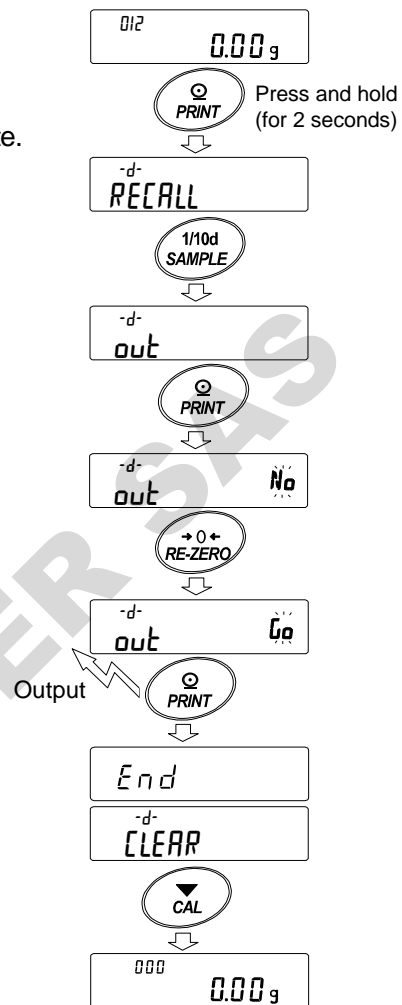

## Deleting all memory data at one time

1. Press and hold the **PRINT** key (for 2 seconds) until **RECALL** is displayed, then release the key.
2. Press the **SAMPLE** key several times to display **CLEAR**.
3. Press the **PRINT** key to display **CLEAR** with "No" blinking.
4. Press the **RE-ZERO** key to display **CLEAR** with "ERR" blinking.
5. Press the **PRINT** key to delete all data
6. The balance displays **End** and returns to the weighing mode.

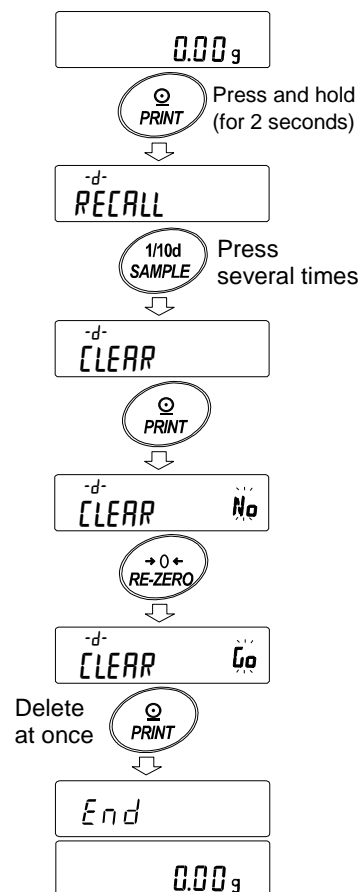

## 13-2 Data Memory For Calibration And Calibration Test

### Characteristic

- Calibration data (when and how it is performed) and calibration test data can be stored in memory.
- All the data in memory is available to be output at one time to a printer or personal computer.
- Up to 50 data sets of the latest sensitivity adjustment or sensitivity calibration can be stored.

Upper left of the display

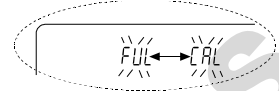

\* When the memory capacity has been reached to 50, "FUL" ↔ "CAL" illuminates in order in the upper left of the display as shown below.

### Storing the calibration and calibration test data

1. Set the "Data memory (DATA)" parameter to "DATA 2". Refer to "11. Function Table".
2. With the settings above, each time calibration or calibration test is performed, the data is stored automatically.

## Transmitting the memory data

1. Press and hold the **[CAL]** key (for 2 seconds) during weighing display. When a **[CAL H.5]** displayed, release your finger from the key to display **[out]**.  
If there is no calibration history, **[No dAtA]** is displayed, and then the display returns to the weighing display.
  2. Press the **[PRINT]** key to display **[out No]**.
  3. Change the **[No] / [50]** with the **[RE-ZERO]** key.  
Display the **[out 50]**.
  4. Press the **[PRINT]** key to start output at one time while **[out 50]** is displayed.  
The output format conforms to "GLP output".
  5. When output at one time is completed, **[CLEAR]** displays after **[End]** is displayed.
  6. If the saved history is deleted all at once, please proceed to "How to delete history". To return to the weighing value, press the **[CAL]** key.
- \* If the **[FULL]** ↔ **[CAL]** indicators blink in turn during weighing display, 50 instance of data are stored.  
If history is saved in this state, old data will be overwritten.  
Optionally delete the saved data.

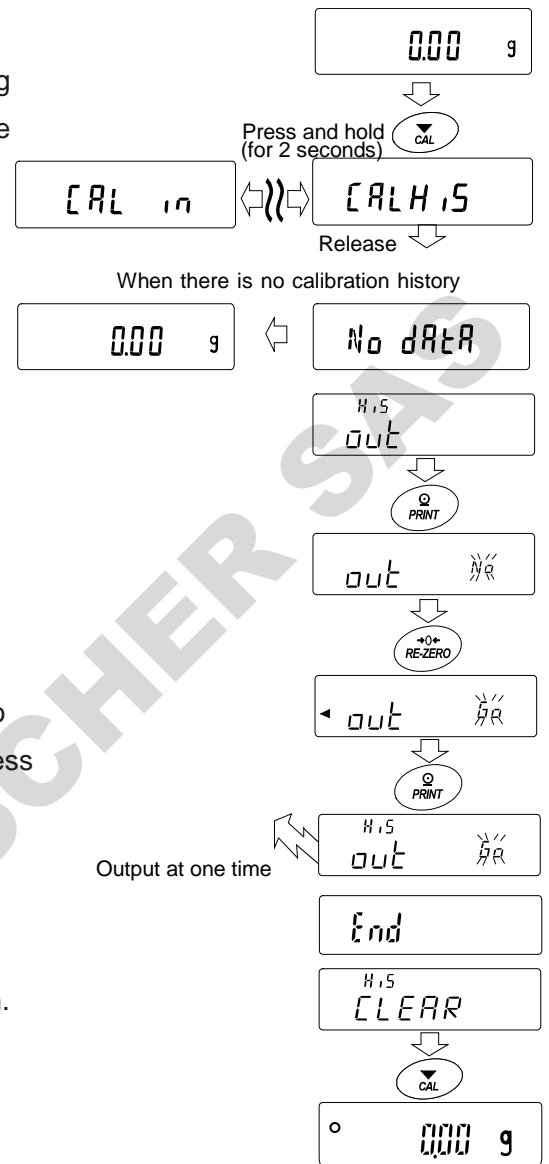

## Deleting data stored in memory

1. Press and hold the **[CAL]** key (for 2 seconds) until **[CAL H.5]** is displayed, then release the key. **[out]** is displayed.
2. Press the **[SAMPLE]** key to display **[CLEAR]**.
3. Press the **[PRINT]** key to display **[CLEAR No.]**.
4. Press the **[RE-ZERO]** key to change **[No.] / [Go.]**.  
Display **[CLEAR Go.]**.
5. Press **[PRINT]** while **[CLEAR Go.]** is displayed, deleting at once is started.
6. When the balance displays **[End]** and returns to the weighing mode.

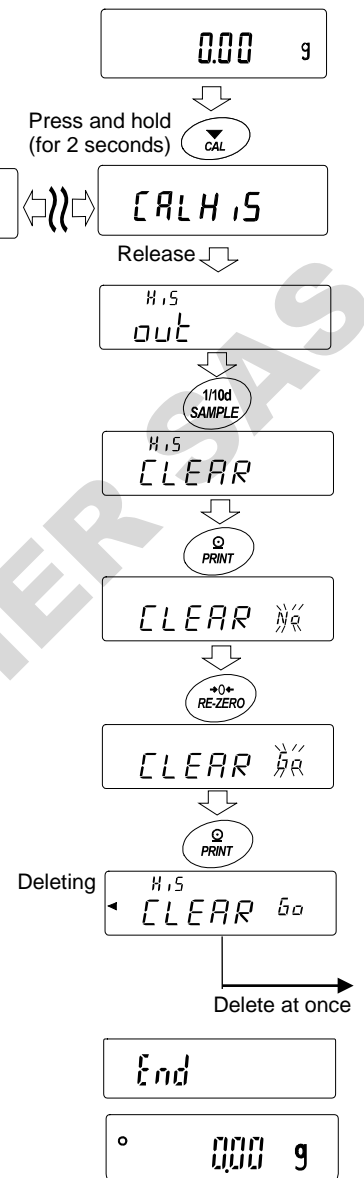

## 13-3 Data Memory for Unit Mass in the Counting Mode

- The balance can store 50 data of unit mass for the counting mode.  
"P0 1" is the standard memory of unit mass. Another 49 data of unit mass can be stored.
- Even if the AC adapter is removed, the data is maintained in non-volatile memory.
- The unit mass in memory can be recalled and used for weighing.
- The unit mass in memory can be recalled and changed.

### Note

- The recalled unit mass can be changed, using the weighing input mode or the digital input mode. The weighing input mode uses the specified number of samples to store the unit mass. The digital input mode enters the unit mass using the keys.

### Storing the unit mass

To store a new unit mass: Recall the stored unit mass to be changed. Then, change the recalled unit mass using the weighing input mode or the digital input mode, and store the new unit mass.

The balance can store a unit mass from " P0 1" to "P50".

1. Set the "Data memory (dAtA)" parameter to " 1".
2. Press the **MODE** key to select **pcs** (counting mode).  
**Note** If the counting mode can not be selected, refer to "5. Weighing Units".
3. Press and hold the **PRINT** key (for 2 seconds) until the balance enters the sample unit mass confirmation mode. The unit mass last selected is displayed
4. Select the unit mass number to be used, using the following keys.  
**RE-ZERO** key To increase the unit mass number by one.  
**MODE** key To decrease the unit mass by one.
5. To change the selected unit mass:
  - To use the weighing input mode, press the **SAMPLE** key to enter the weighing input mode. Go to "Weighing input mode" on the next page.
  - To use the digital input mode, press the **SAMPLE** key, then press and hold the **MODE** key to enter the digital input mode. Go to "Digital input mode" on the next page.

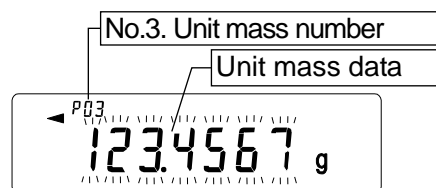

## Notes

- ACAI can not be performed directly on the recalled unit mass.
- Using the "UN: mm" command, the unit mass can be recalled.  
The unit mass recalled can be output using the "?UW" command.  
The unit mass can be changed using the "UW:" command.  
"mm" indicates a two-digit numerical value 01 to 50, which corresponds to P01 - P50.

## Weighing input mode

In the weighing input mode, the specified number of samples is placed on the pan to store the unit mass. Re-storing the unit mass or performing Automatic Counting Accuracy Improvement (ACAI) on the re-stored unit mass is possible. Follow the procedure described in "6-2. Counting Mode (PCS)".

Use the following keys to store a unit mass in the weighing input mode.

**RE-ZERO** key... To set the display to zero. 10 - pcs → 10 0 pcs

**SAMPLE** key... To change the number of samples to be stored. 10 0 pcs → 25 0 pcs

**PRINT** key... Press, after a sample is placed, to store the unit mass. Go to step 3 of the previous page.

**CAL** key... To return to the unit mass confirmation mode. Go to step 3 of the previous page.

**MODE** key... Press and hold (for 2 seconds) to go to the digital input mode.

## Digital input mode

To use this mode, the sample unit mass must be known beforehand. In the digital input mode, the unit mass value is entered digitally using the keys. The display in the digital input mode is shown to the right.

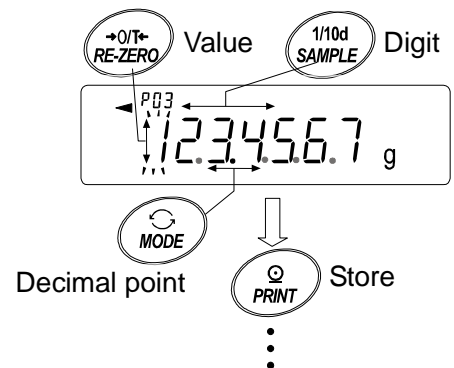

**Note** ACAI can not be used on the unit mass stored using the digital input mode.

Use the following keys to store a unit mass in digital input mode.

**SAMPLE** key... To select the digit to be changed.

**RE-ZERO** key... To change the value of the selected digit.

**MODE** key... To change the decimal point position.

**PRINT** key... To store the unit mass. Go to step 3 of the previous page.

**CAL** key... To return to the unit mass confirmation mode. Go to step 3 of the previous page.

**MODE** key... Press and hold (for 2 seconds) to go to the weighing input mode.

**Note** If the new unit mass is out of the setting range, "Error 2" is displayed. Refer to "28. Specifications" for the minimum unit mass.

## Recalling the unit mass

1. Follow steps 1 through 3 in "Storing the unit mass" on the previous page, to enter the sample unit mass confirmation mode.
2. Select the unit mass number using the following keys.  

<b>RE-ZERO</b> key	To increase the unit mass number by one.
<b>MODE</b> key	To decrease the unit mass by one.
3. Press the **PRINT** key to confirm the selection and to return to the weighing mode.  
To cancel the selection and return to the weighing mode, press the **CAL** key.

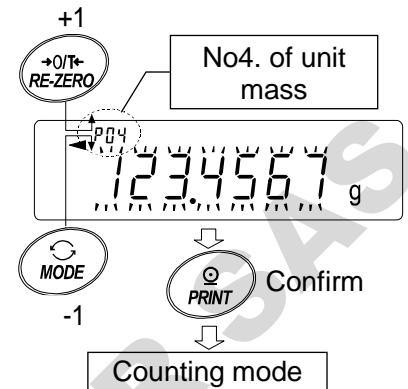

## 13-4 Data Memory for Comparator Settings

- The data memory function can store 20 sets of upper and lower limit values for the comparator mode. The reference value or tolerance value for the comparator mode can not be stored in memory.
- The upper and lower limit values in memory can be recalled easily using the **MODE** key and used for weighing.
- The upper and lower limit values in memory can be recalled and changed.

### Note

The recalled upper and lower limit values can be changed, using the digital input mode or the weighing input mode. The digital input mode enters the upper and lower limit values using the keys. The weighing input mode uses a sample to store the upper and lower limit values.

### Storing the upper and lower limit values

To store new upper and lower limit values: Recall the stored upper and lower limit values to be changed ("C01" to "C20"). Then, change the recalled upper and lower limit values using the digital input mode or the weighing input mode, and store the new value.

### Note

- While the data memory function is in use, unit selection using the **MODE** key is not available.

1. Press the **MODE** key to select a unit to be used for storage.
2. Set the "Data memory (DATA)" parameter to "3".
3. Press and hold the **PRINT** key (for 2 seconds) until the balance enters the upper and lower limit values confirmation mode. The upper limit value last selected is displayed.

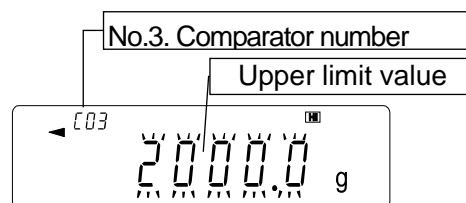

4. Select the comparator number to be used, using the following keys.

**RE-ZERO** key .....To increase the comparator number by one.

**MODE** key .....To decrease the comparator number by one.

Each time the **RE-ZERO** key or **MODE** key is pressed, the displayed value changes as follows:  $\leftrightarrow$  C03 **HI**  $\leftrightarrow$  C03 **LO**  $\leftrightarrow$  C04 **HI**  $\leftrightarrow$  C04 **LO**  $\leftrightarrow$

In case of 5 level comparison, the displayed value changes in order of ... $\leftrightarrow$  C03 **HI** blinking  $\leftrightarrow$  C03 **HI**  $\leftrightarrow$  C03 **LO**  $\leftrightarrow$  C03 **LO** blinking  $\leftrightarrow$  C04 **HI** blinking.

5. To change the selected upper and lower limit values:

- To use the digital input mode, press the **SAMPLE** key to enter the digital input mode. Go to "Digital input mode" on the next page.
- To use the weighing input mode, press the **SAMPLE** key, then press and hold the **MODE** key to enter the weighing input mode. Go to "Weighing input mode" on the next page.



## Notes

- Using the "CN:mm" command, the comparator limit values can be recalled. The upper limit value recalled can be output using the "?HI" command. The lower limit value recalled can be output using the "?LO" command. The upper limit value can be changed using the "HI:" command. The lower limit value can be changed using the "LO:" command. "mm" indicates a two-digit numerical value 01 to 20, which corresponds to C01 - C20.

## Digital input mode

In the digital input mode, the upper and lower limit values are entered digitally using the keys. Use the following keys to store upper and lower limit values in digital input mode.

- SAMPLE** key.....To select the digit to be changed.
- RE-ZERO** key...To change the value of the selected digit.
- MODE** key.....To switch the polarity.
- PRINT** key.....To store the upper and lower limit values. Go to step 3 of the previous page.
- CAL** key.....To return to the upper and lower limit values confirmation mode Go to step 3 of the previous page.
- MODE** key Press and hold (for 2 seconds) to go to the weighing input mode.

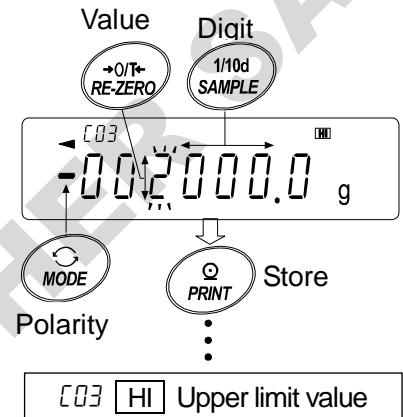

## Weighing input mode

In the weighing input mode, a sample is placed on the pan to store the upper and lower limit values.

## Notes

- Pressing the **CAL** key will interrupt the operation and the balance will return to the upper and lower limit values confirmation mode (step 3 in "Storing the upper and lower limit values").
  - To go to the digital input mode, press and hold the **MODE** key (for 2 seconds).
- The first display in the weighing input mode depends on the comparator number selected in step 4 in "Storing the upper and lower limit values". For example, when "C03 HI" is selected in step 4, the display is the current weight value and the comparator number with **HI** illuminating. In case of second upper limit value, **HI** blinks
  - Place a container on the weighing pan, if necessary. Press the **RE-ZERO** key to set the display to zero.
  - Place a sample corresponding to the upper limit value, on the pan or in the container.
  - Press the **PRINT** key to store the upper limit value.

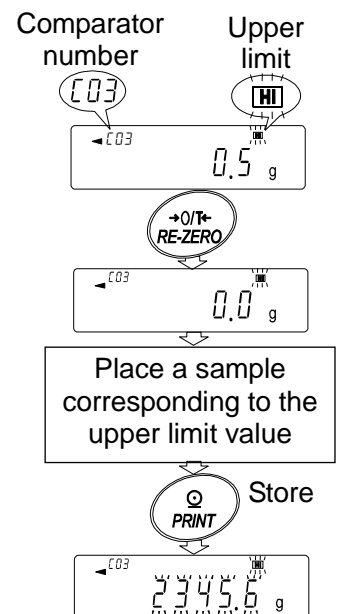

## Recalling the upper and lower limit values (Quick selection mode)

The procedure below describes an easy way to recall the upper and lower limit values to be used for weighing. When the recalled upper and lower limit values are to be changed, refer to "Storing the upper and lower limit values".

### Note

- Refer to "Storing the upper and lower limit values" for the method to store the upper and lower limit values.

1. Set the "Data memory (dAtA)" parameter to "3".
2. Press the **MODE** key to enter the upper/lower limit value recalling mode. The upper limit value last selected with its comparator number appears. The display is as shown to the right, with all the digits blinking.
3. Press the **MODE** key to select the value. Each time the **MODE** key is pressed, the displayed value changes as follows:  
 (.....↔ [03] [HI] ↔ [03] [LO] ↔ [04] [HI] ↔ [04] [LO] ↔ .....)  
 ↔ .....)
4. Press the **PRINT** key to confirm the selection. The balance returns to the weighing mode with the selected upper and lower limit values ready for use.

**Note** To cancel the selection, press the **CAL** key. The balance returns to the weighing mode.

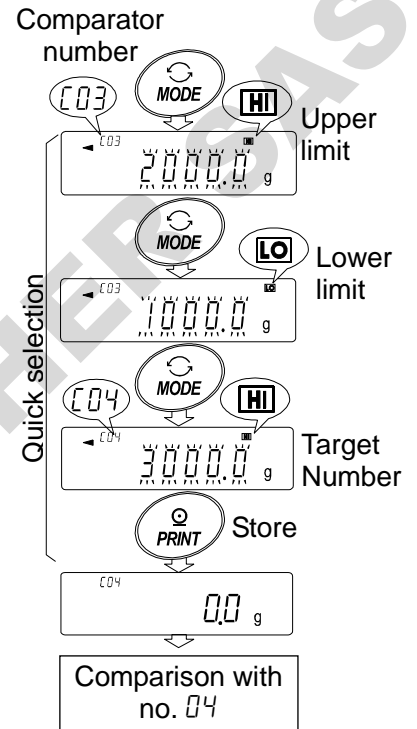

## 13-5 Data Memory for Tare Value

- The data memory function can store 20 sets of tare values for weighing.
- The tare value in memory can be recalled easily using the **MODE** key and used for weighing.
- The tare value in memory can be recalled and changed.

### Notes

- **The recalled tare value can be changed, using the digital input mode or the weighing input mode. The digital input mode enters the tare value using the keys. The weighing input mode uses a sample tare container to store the tare value.**
- **The NET indicator illuminates during tare operation.**

### Storing the tare value

To store a new tare value: Recall the stored tare value to be changed ("t01" to "t20"). Then, change the recalled tare value using the digital input mode or the weighing input mode, and store the new value.

### Notes

- **The recalled tare value can be changed, using the digital input mode or the weighing input mode. The digital input mode enters the tare value using the keys. The weighing input mode uses a sample tare container to store the tare value.**
- **When the **RE-ZERO** key is pressed with nothing placed on the weighing pan, zero is displayed, The NET indicator does not illuminate.**
- **"t--" appears when a tare operation is performed without using the tare value stored in memory.**
- **While the data memory function is in use, unit selection using the **MODE** key is not available.**

1. Press the **MODE** key to select a unit to be used for storage.
2. Set the "Data memory (dMEm)" parameter to "4".
3. Press and hold the **PRINT** key (for 2 seconds) until the balance enters the tare value confirmation mode. The tare value last selected is displayed.
4. Select the tare number to be used, using the following keys.

**RE-ZERO** key.....To increase the tare number by one.

**MODE** key .....To decrease the tare number by one.

**CAL** key.....To cancel it and to return to the weighing mode.

Each time the **RE-ZERO** key or **MODE** key is pressed, the displayed value changes as follows: ↔ t03 ↔ t04 ↔ .....↔ t20 ↔ t01 ↔

5. To change the selected tare value:

- To use the weighing input mode, press the **SAMPLE** key to enter the weighing input mode. Go to "Weighing input mode" on the next page.
- To use the digital input mode, press the **SAMPLE** key, then press and hold the **MODE** key (for 2 seconds) to enter the digital input mode. Go to "Digital input mode" on the next page.

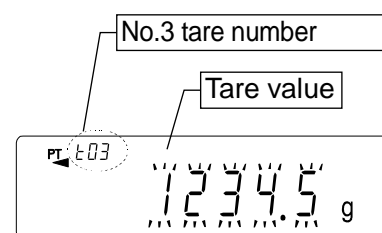

## Notes

- Using the "PN:mm" command, the tare value can be recalled.  
The tare value recalled can be output using the "?PT" command.  
The tare value can be changed using the "PT:" command.  
"mm" indicates a two-digit numeral value 01 to 20, which corresponds to  $\epsilon 0.1 - \epsilon 20$ .

## Weighing input mode

In the weighing input mode, a sample tare container is placed on the pan to store the tare value.

### Note

- Pressing the **CAL** key will interrupt the operation and the balance will return to the tare value confirmation mode (step 3 in "Storing the tare value").
- To go to the digital input mode, press and hold the **MODE** key.
  - The first display in the weighing input mode is the current weight value and the selected tare number with **PT** blinking.
  - Press the **RE-ZERO** key to set the display to zero.
  - Place a tare (a container) on the weighing pan.
  - Press the **PRINT** key to store the tare value.  
Remove the tare from the pan.

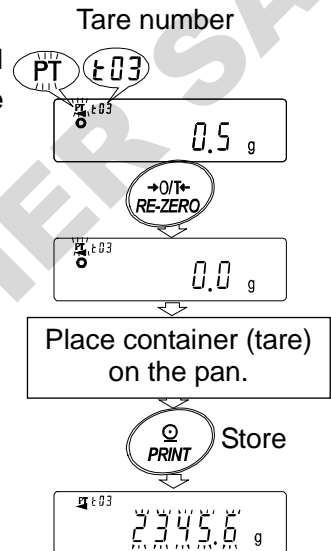

## Digital input mode

In the digital input mode, the tare value is entered digitally using the keys. Use the following keys to store a tare value in digital input mode.

- SAMPLE** key .... To select the digit to be changed.
- RE-ZERO** key... To change the value of the selected digit.
- PRINT** key..... To store the tare value.  
Go to step 3 of "Storing the tare value".
- CAL** key..... To return to the tare value confirmation mode.  
Go to step 3 of "Storing the tare value".
- MODE** key..... Press and hold to go to the weighing input mode.

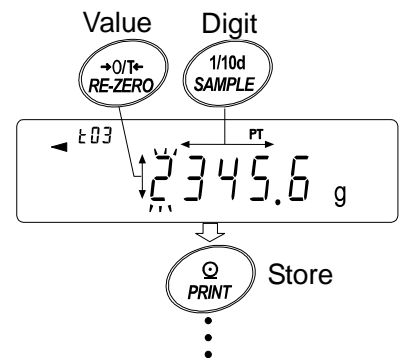

### Recalling the tare value (Quick selection mode)

The procedure below describes an easy way to recall the tare value to be used for weighing. When the recalled tare value is to be changed, refer to "Storing the tare value".

1. Set the "Data memory (DATA)" parameter to "4".
2. Press the **MODE** key to enter the quick selection mode. After entering quick selection mode, display shows tare value (blinking), "PT" mark and tare value number. A prior selected setting value is displayed.
3. Press the **MODE** key to select the value. Each time the **MODE** key is pressed, the displayed value changes as follows:  
(.....↔ t03 ↔ t04 ↔ .....↔ t20 ↔ t01 ↔ ...)
4. Press the **PRINT** key to confirm the selection. The balance returns to the weighing mode with the selected tare value ready for use.

**Note** To cancel the selection, press the **CAL** key. The balance returns to the weighing mode.

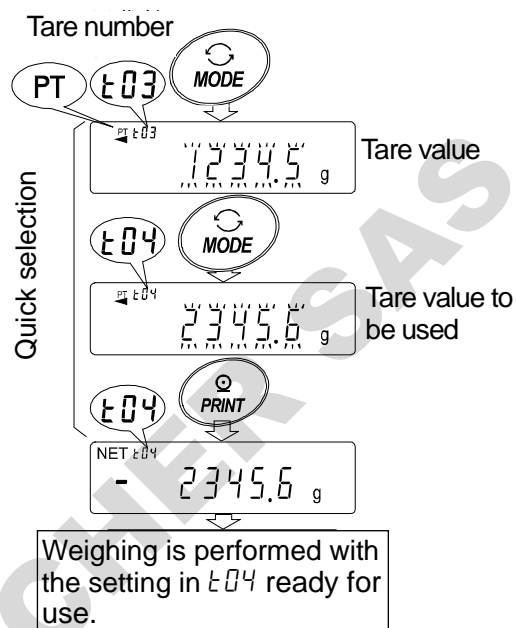

### Canceling the tare value data

Cancel the tare value data as follows:

1. Remove everything from the weighing pan and press the **RE-ZERO** key to cancel the tare value.

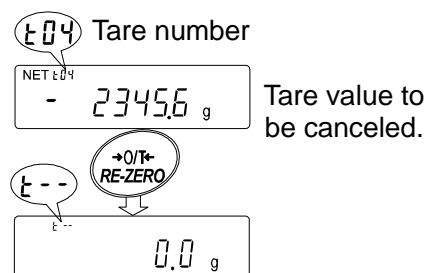

## 13-6 Data Memory: Quick Selection Mode

The data memory has a quick selection mode to recall data in memory quickly.

Using the quick selection mode, the comparator settings or the tare value, whichever is selected in the function table, can be recalled, by a simple operation, using the **MODE** key.

### Note

- While the data memory function is in use, unit selection using the **MODE** key is not available.

Use the quick selection mode as follows:

- Press the **MODE** key to enter the quick selection mode.  
The memory data last selected appears with all the digits blinking.
- Press the **MODE** key to select the value.

### Comparator settings: when the "Data memory (dAtA)" parameter is set to "3"

Each time the **MODE** key is pressed, the displayed value changes as follows:

(.....↔ 003 **HI** ↔ 003 **LO** ↔ 004 **HI** ↔ 004 **LO** ↔ .....

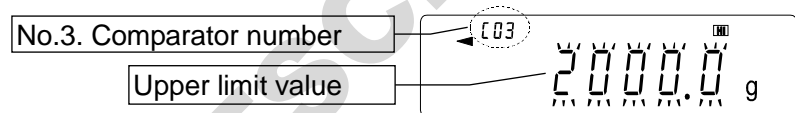

### Tare value: when the "Data memory (dAtA)" parameter is set to "4"

Each time the **MODE** key is pressed, the displayed value changes as follows:

(.....↔ t03 ↔ t04 ↔ .....↔ t20 ↔ t01 ↔ .....

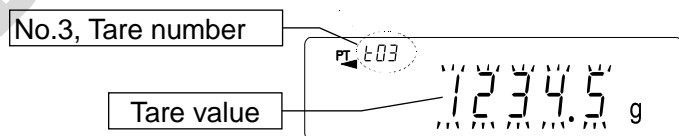

- Press the **PRINT** key or leave the balance as is for a while (after a few seconds of inactivity) to confirm the selection. The balance returns to the weighing mode with the selected data ready for use.

**Note** To cancel the selection, press the **CAL** key. The balance returns to the weighing mode

## 13-7 Data Memory: Confirmation and Storage Mode

The confirmation and storage mode can change and store the recalled data.

Of the three types of memory data listed below, one may be selected in the function table, and is available for changes using this mode.

- Unit mass in the counting mode
- Comparator settings
- Tare value

### Notes

- **To change the memory data other than specified in the function table, re-set the Data memory (dAtA)" parameter of the function table.**
- **For a detailed description of the procedure for each memory data, see the relevant section.**

Use the confirmation and storage mode as follows.

1. Press and hold the **PRINT** key (for 2 seconds) to enter the memory data recalling mode. The memory data last selected appears with all the digits blinking.

2. Use the following keys to select the value.

**RE-ZERO** key .....To increase the memory data number by one.

**MODE** key .....To decrease the memory data number by one.

### Unit mass: when the "Data memory (dAtA)" parameter is set to "1"

Each time the **MODE** key or **RE-ZERO** key is pressed, the displayed value changes as follows: .....↔ P03 ↔ P04 ↔ .....

The balance can select "P01" to "P50".

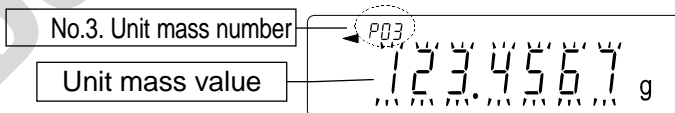

### Comparator settings: when the "Data memory (dAtA)" parameter is set to "3"

Each time the **MODE** key or **RE-ZERO** key is pressed, the displayed value changes as follows: .....↔ C03 HI ↔ C03 LO ↔ C04 HI ↔ C04 LO ↔ .....

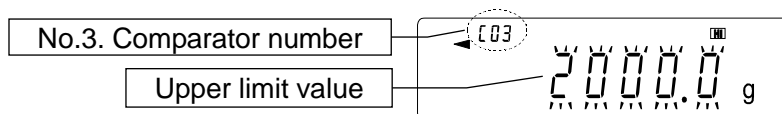

### Tare value: when the "Data memory (dAtA)" parameter is set to "4"

Each time the **MODE** key or **RE-ZERO** key is pressed, the displayed value changes as follows: .....↔ t03 ↔ t04 ↔ .....↔ t20 ↔ t01 ↔ .....

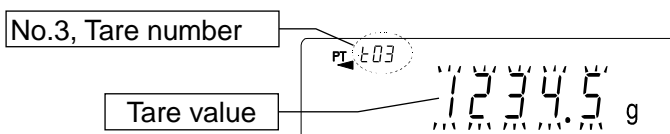

3, Select a method.

- To perform a weighing using the selected memory data  
Press the **PRINT** key to confirm the selection. The balance will return to the weighing mode with the selection ready for use.
  
- To change and store the selected memory data  
Press the **SAMPLE** key to enter the storage mode.  
Two inputting modes are available for entering the value to be stored.  
Digital input mode  
Weighing input mode
  
- To switch the inputting mode, press and hold the **MODE** key (for 2 seconds).
  
- To cancel the operation and return to the weighing mode, press the **CAL** key.

DOMINIQUE DUTSCHER SAS



# 14. Statistical Calculation Mode

The statistical calculation mode statistically calculates the weight data, and displays or outputs the results. To use the statistical calculation mode, set the "Application function (APF)" parameter of "Application (AP Fnc)" in the function table to "2", as described below. To return to the normal weighing mode (factory setting), set "Application mode (APF)" to "0".

Statistical items available are number of data, sum, maximum, minimum, range (maximum-minimum), average, standard deviation and coefficient of variation. What statistical items to output can be selected from the four modes in the function table (Stat APF).

- The wrong data input can be canceled by the key operation, if immediately after the input.
- Turning the balance off will delete the statistical data.
- The standard deviation and coefficient of variation are obtained by the equation below:

$$\text{Standard deviation} = \sqrt{\frac{N \cdot \sum (X_i)^2 - (\sum X_i)^2}{N \cdot (N-1)}} \quad \text{where } X_i \text{ is the } i\text{-th weight data,}$$

N is number of data.

$$\text{Coefficient of variation (CV)} = \frac{\text{Standard deviation}}{\text{Average}} \times 100 (\%)$$

$$\text{Relative error of maximum value} = \frac{\text{Maximum value} - \text{Average}}{\text{Average}} \times 100 (\%)$$

$$\text{Relative error of minimum value} = \frac{\text{Minimum value} - \text{Average}}{\text{Average}} \times 100 (\%)$$

### Note

- When there is data with a minimum display digit off, the calculation result is displayed with the minimum display digit off. (Minimum display digit is rounded off.)
- When the data memory function is in use, the statistical calculation function cannot be used.
- When registering the warning function of the minimum weighing value, the statistical calculation function cannot be used.

## 14-1 How To Use The Statistical Calculation

### Switching to the Statistical Function Mode (Changing The Function Table)

1. Press and hold the **SAMPLE** key (for 2 seconds) until **bASFnC** of the function table is displayed, then release the key.
2. Press the **SAMPLE** key several times to display **AP Fnc**.
3. Press the **PRINT** key to display **APF 0.000**.
4. Press the **RE-ZERO** key several times to display **APF 5.000**.

To select statistical items to output, go to step 5.

To store the statistical function mode setting, go to 7.

To disable the statistical calculation mode, press the

**RE-ZERO** key to select **APF 0.000**.

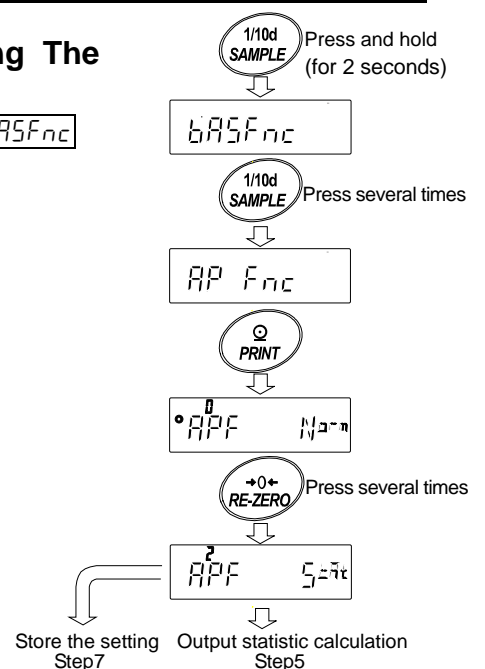

## Selecting the statistical items to output

- Press the **SAMPLE** key to display  $\overset{0}{\circ} \text{STAT} \text{ } \bar{x}$ .
- Press the **RE-ZERO** key to select the output items. In the example, output the number of data, sum, maximum, minimum, range (maximum-minimum) and average are selected.

Parameter	Description
0	Number of data, sum
1	Number of data, sum Maximum, minimum, range (maximum – minimum), average
2	Number of data, sum Maximum, minimum, range (maximum – minimum), average, Standard deviation, coefficient of variation
3	Number of data, sum Maximum, minimum, range (maximum – minimum), average, Standard deviation, coefficient of variation Relative error of maximum value, relative error of minimum value

- Press the **PRINT** key to store the setting.
- Press the **CAL** key to return to the weighing mode.

## Selecting the unit

- Press the **MODE** key to select the unit to be used for the statistical calculation mode. In the example shown at the right, gram (g) is selected.

## Note

Selecting the unit using the **MODE** key is not available after the data is entered. In this case, clear the data as described on page 99 "Cleaning the statistical data" and select the unit using the **MODE** key.

When the unit used for the statistical calculation mode is to be enabled upon power-on, select the unit in "Unit (Unit)" of the function table beforehand.

Continue from Step4

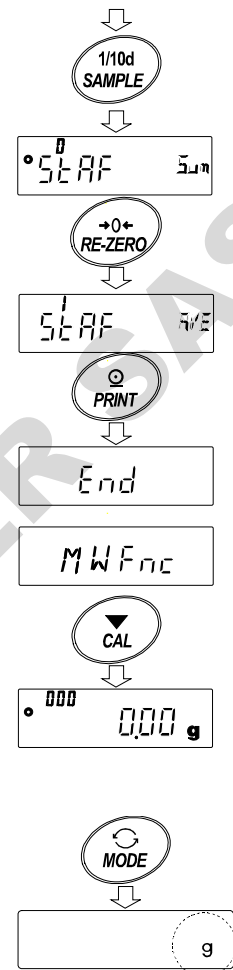

## Entering data for statistical calculation

Use the following keys to operate the statistical calculation mode.

**MODE** key..... When the data is entered, moves between the displaying items (weighing mode, statistical results and data operation) each time the key is pressed.

When no data has been entered, selects the unit.

**SAMPLE** key .....Turns the minimum weighing value ON or OFF, in the weighing mode.

**RE-ZERO** key.....Sets the display to zero in the weighing mode.

**PRINT** key..... Outputs the data number and the weight data and includes the weight data to statistical calculation in the weighing mode. (Output is not in the data format specified in the function table because of the data number added.)

Outputs the statistical results while the statistical results are displayed. (Output is not in the data format specified in the function table.)

**CAL** key..... Returns to the weighing mode.

1. Press the **RE-ZERO** key to set the display to zero.
2. Place the sample on the weighing pan and wait for the stabilization indicator to turn on.
3. Press the **PRINT** key to add the data displayed to statistical calculation. The number of data on the upper left of the display increases by 1.
4. Repeat steps 1 to 3 for each weighing.

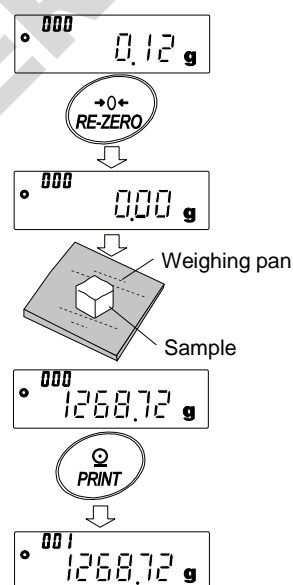

## Outputting the statistical results

- Each time the **MODE** key is pressed, the display changes: the results as selected in "Statistical function mode output items (SEAF)", and **CLEAR**, **CANCEL**.  
When pressing the **SAMPLE** key, the previous item is displayed.

### Note

- When the number of data is 1, the coefficient of variation and relative error is displayed as **-----**.
- When the average is 0, the coefficient of variation and relative error is displayed as **-----**.
- Statistical items are indicated on the upper left of the display using the following symbols.

- When pressing the **PRINT** key while displaying the statistical result, the statistical result is output.

Symbol	Statistical item
$\Sigma \bar{n}$	Sum
$\bar{n} \uparrow$	Maximum
$\bar{n} \downarrow$	Minimum
$r$	Range (Maximum – minimum)
$\bar{Ave}$	Average
$Sd$	Standard deviation
$\bar{Cv}$	Coefficient of variation
$\bar{n} \uparrow \%$	Relative error of maximum value
$\bar{n} \downarrow \%$	Relative error of minimum value

## Deleting the latest data

When the wrong data is entered, it can be deleted and excluded from statistical calculation. Only the latest data can be deleted.

- In the weighing mode, press the **MODE** key several times to display **CANCEL**.
- Press the **PRINT** key to display **CANCEL** with a lightning bolt symbol.
- Press the **RE-ZERO** key to display **CANCEL** with a lightning bolt and a cross symbol.
- Press the **PRINT** key to delete the latest data and exclude it from statistical calculation.  
The number of data decreases by 1 when the balance returns to the weighing mode.

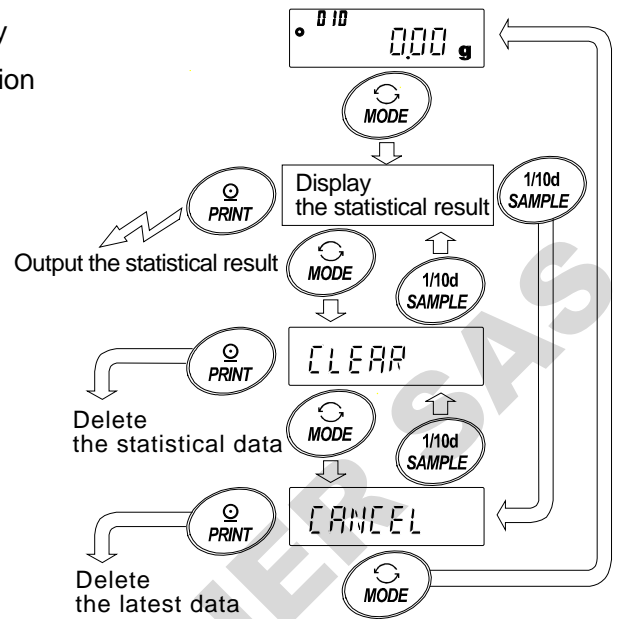

## Output example

Function table parameter	
N	10
SUM	1000.00g
MAX	105.00g
MIN	95.00g
R	10.00g
AVE	100.00g
SD	2.800g
CV	2.8 %
MAX%	5.0 %
MIN%	5.0 %

0.00 g

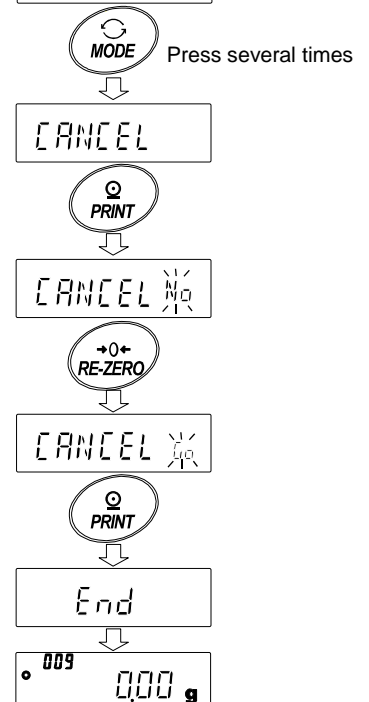

## Clearing the statistical data

All the statistical data will be deleted and the number of data will be 0 (zero).

1. In the weighing mode, press the **MODE** key several times, to display **CLEAR**.
2. Press the **PRINT** key to display **CLEAR No**.
3. Press the **RE-ZERO** key to display **CLEAR**.
4. Press the **PRINT** key to delete the statistical data.  
The number of data becomes 0 (zero) when the balance returns to the weighing mode.

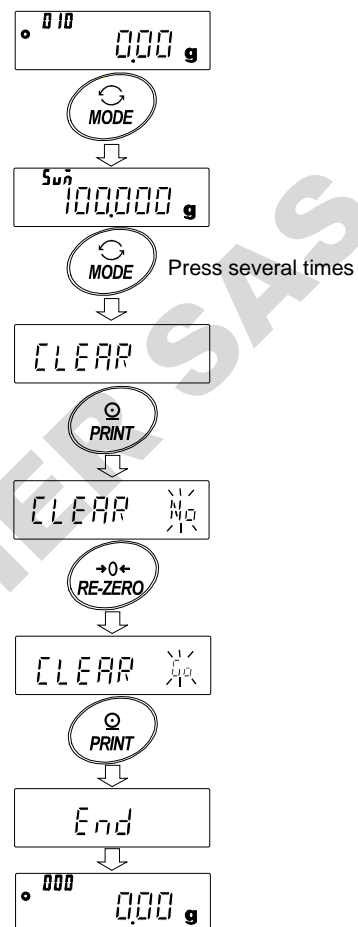

## 14-2 Statistical Calculation Mode (Example Of Use)

Here, as an example of use of the statistical calculation mode, mixing of the multiple formulae such as medicine is described. The mixing process is recorded using the balance and the printer.

In the example, the GX-10202M and the AD-8126 or AD-8127 are connected using the RS-232C serial interface.

### Changing the function table

- Changes
- To enable the statistical calculation mode
  - To enable “Zero after output”

### Enabling the statistical calculation mode

1. Enter the function table menu.

Press and hold the **[SAMPLE]** key (for 2 seconds) until **bASFnC** of the function table is displayed, then release the key.

2. Select the application function.

Press the **[SAMPLE]** key several times to display **RP FnC**.

Then, press the **[PRINT]** key to display **•APF N=1**.

3. Change the application function parameter to “2”.

Press the **[RE-ZERO]** key to display **APF 2=1**.

Press the **[PRINT]** key to confirm the change.

After **[End]**, **MW FnC** is displayed.

### Enabling “Zero after output”

4. Select “Zero after output”.

Press the **[SAMPLE]** key several times to display **dout**. Then,

press the **[PRINT]** key to display **•Pr-t 1=**,

and press the **[SAMPLE]** key several times to display **•Pr-d 1=**.

5. Enable “Zero after output”.

Press the **[RE-ZERO]** key to display **Pr-d 1=**. Then,

press the **[PRINT]** key to confirm the change.

After **[End]**, **SIF** is displayed.

### Returning to the weighing mode

6. Press the **[CAL]** key to return to the weighing mode.

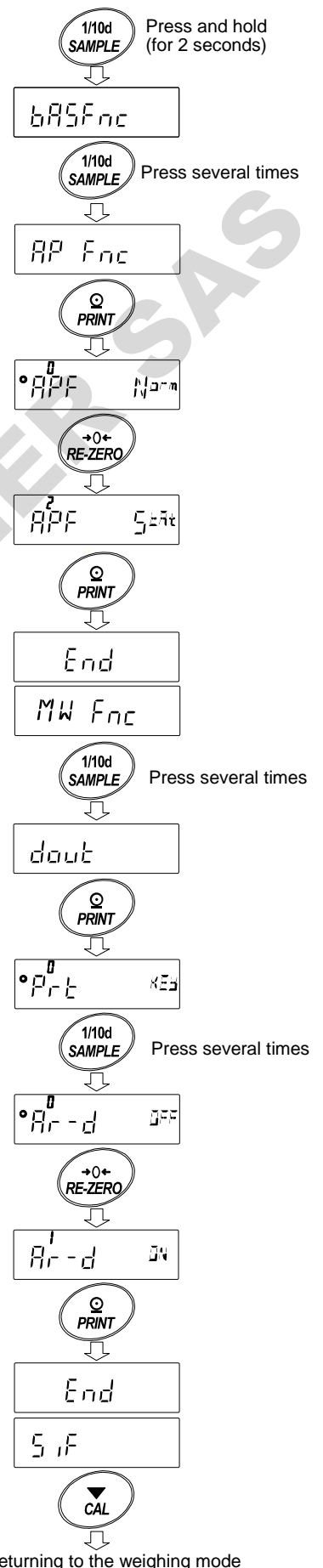

## Using The Statistical Calculation Mode

- Press the **RE-ZERO** key to set the display to zero.
- Place a container on the weighing pan.  
Press the **PRINT** key to cancel the weight (tare). The balance displays **0.00 g**. (Storing the tare value)  
The tare value data is output when the peripheral output equipment is connected.
- Weigh formula 1 and press the **PRINT** key. The balance displays **0.00 g**. (Storing the weight value of formula 1)  
The weight value data is output when the peripheral output equipment is connected.
- Weigh formula 2 and press the **PRINT** key.  
The balance displays **0.00 g**. (Storing the weight value of formula 2)  
The weight value data is output when the peripheral output equipment is connected.
- When there are some more formulae to be added, repeat step 4.
- After mixing is complete, press the **MODE** key to display the statistical results.
- Press the **PRINT** key to output the number of data saved including the tare value and the total weight.

### Output example

No. 1	
ST, +00056.37 g	----- Tare value
No. 2	
ST, +00019.92 g	----- Formula 1
No. 3	
ST, +00077.80 g	----- Formula 2
N	3
SUM	+154.09 g
	----- Total weight

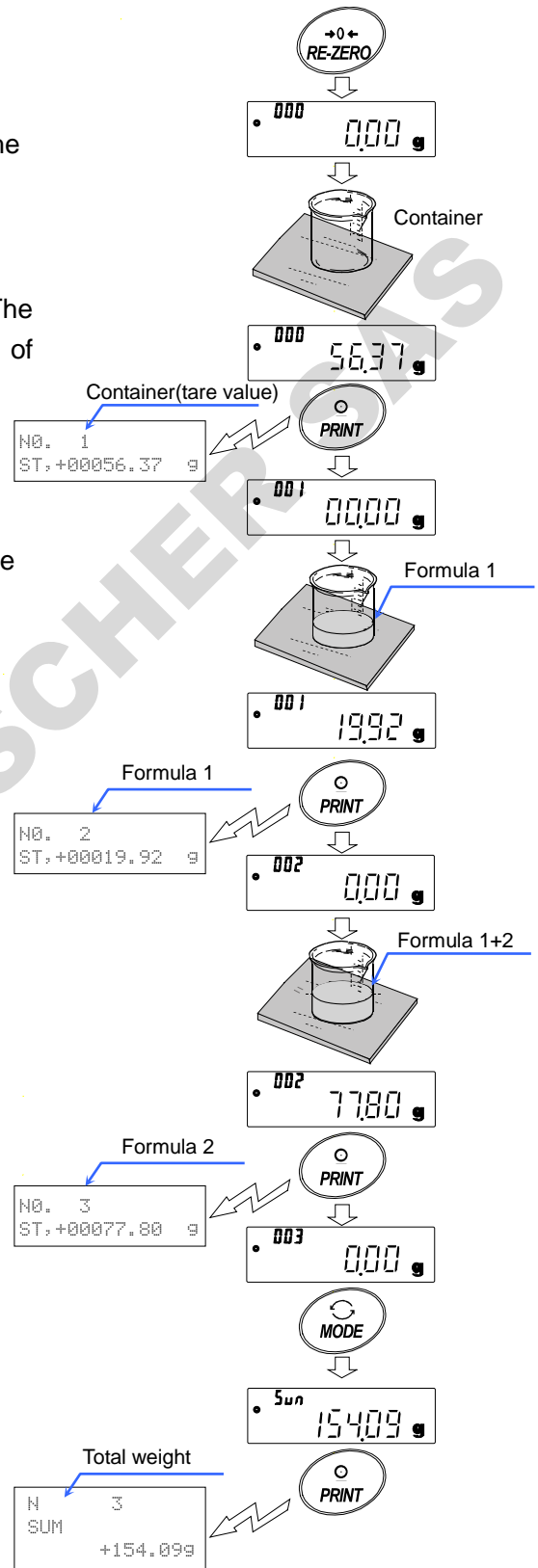

# 15. Flow Measurement

The balance has a "flow mode" that calculates the amount of change in the weighing value per hour. For details, please refer to "Supplementary information" which can be downloaded from the A&D website (<http://www.aandd.jp>).

- If the flow unit is set to mL/\*, density can be registered. The maximum number of registrations is 10, and if density is set in advance, it can be selected according to the measurement sample.
- The flow rate value is calculated by the following formula.

$$Q = \frac{W - W'}{Ct}$$

Q : Flow rate

Ct : Calculation time

W : Current calculated value

W' : Weight value before Ct

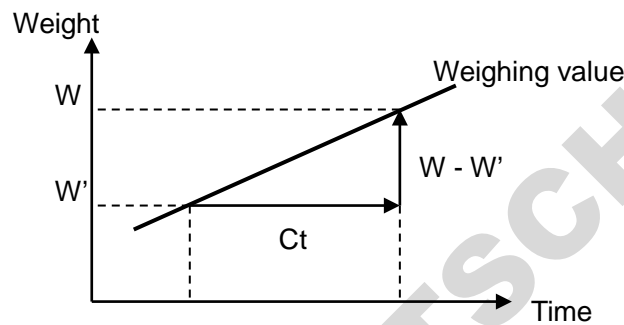

For flow rate calculation time Ct, select manual / automatic and set.

## 15-1 How To Use Flow Measurement

### Enable flow rate measurement

Switch flow rate measurement (Change the Function Table)

1. Press and hold the **SAMPLE** key (for 2 seconds) until **bASFnC** of the function table is displayed, then release the key.
2. Press the **SAMPLE** key several times to display **APFnC**.
3. Press the **PRINT** key to display **APFn**.
4. Press the **RE-ZERO** key several times to display **APFn Frd**.

If you want to change the flow rate unit, go to "5".

If you want store the setting, go to "7".

If you want to cancel the flow function, press the **RE-ZERO** key and return to **APFn**.

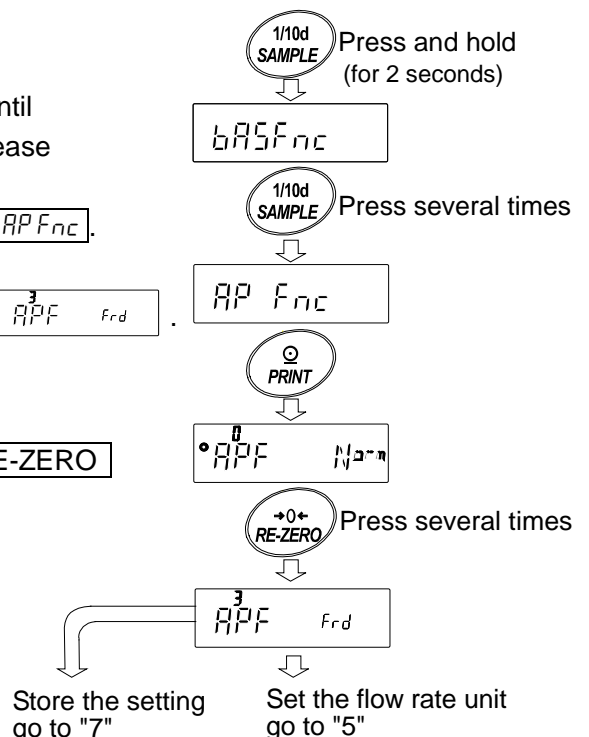



## Setting of flow rate unit

5. Press the **SAMPLE** key to display  $^{\circ} Frd Unit$ .
6. Press the **RE-ZERO** key to set the setting value.

Parameter	Contents
0	g / s (gram/second)
1	g / m (gram/minute)
2	g / h (gram/hour)
3	mL / s (milliliter/second)
4	mL / m (milliliter/minute)
5	mL / h (milliliter/hour)

7. Press the **PRINT** key to store.
8. Press the **CAL** key to return to the calculating display.

- Factory setting

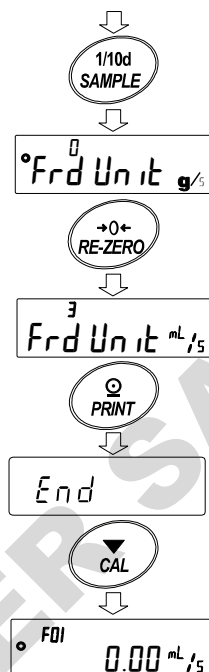

## Manual / automatic selection of flow calculation time Ct.

There are two ways to set flow calculation time Ct, either by automatic setting in the balance according to the flow rate value or by manually determining a fixed value.

To switch between manual and automatic, please perform the following operation.

In factory setting, flow calculation time Ct is set to manual input setting (  $Ct Auto OFF$  ).

1. Please perform the following operation from the  $^{\circ} Frd Unit mL/s$  display for flow unit setting as shown in "15-1. How To Use Flow Measurement".
2. Press the **SAMPLE** key to display  $^{\circ} Ct Auto$ .
3. Press the **RE-ZERO** key to change ON/OFF.
4. Press the **PRINT** key to store.
5. Press the **CAL** key to return to the calculation display.

- \* If set to "OFF", refer to "How to set calculation time by manual setting" to set the flow calculation time.
- If set to "ON", refer to "How to set calculation time by automatic setting" to set the flow calculation precision.

From setting of flow rate unit

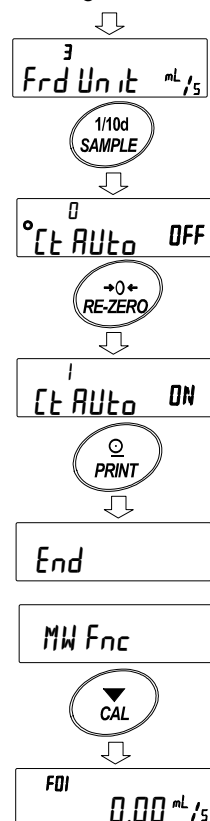

## How to set flow calculation time by manual setting

The flow calculation time Ct can be set by the following procedure.

1. In weighing display, press and hold the **MODE** key (for 2 seconds) to display  $\epsilon t$  2 SEC.

2. Calculation time can be changed by following key operation.

The setting range is 1 second to 1 hour.

**RE-ZERO**(+) key ..... Change calculation time

**MODE**(-) key ..... Change calculation time

**PRINT** key ..... Store setting value

If the flow rate unit is g / \*,  
the display will return to weighing display.

When the flow rate unit is mL / \*,  
the display goes to density setting display.

**CAL** key ..... It returns to weighing display or flow display  
without storing the set value.

\* Unit of time setting (second(s),minute(m) or hour(h)) is entered  
in " \* " of "g/\*" and "mL/\*".

For setting target values, refer to "GX-M/GF-M Series Flow  
Measurement Function Supplementary Manual".

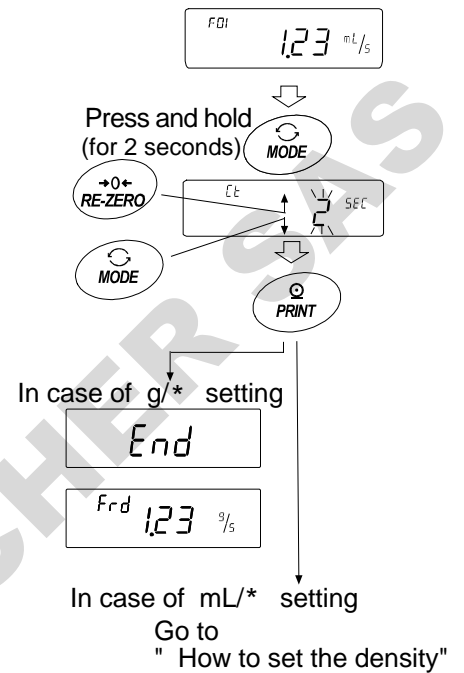

## How to set flow calculation time by automatic setting

It is possible to perform flow measurement without going to the trouble of selecting the flow rate calculation time Ct that matches the flow rate from the setting value.

The flow calculation time Ct is decided according to the flow rate value measured in 1 to 60 seconds. Accuracy can be selected from "Precision Priority (Resolution 500)", "Standard Setting (Resolution 200)" and "Response Priority (Resolution 50)".

The flow rate calculation precision can be changed by the following procedure.

1. Press and hold **MODE** key (for 2 seconds) to display

$F_r RES$  during weighing display.

2. Press the **RE-ZERO** key to change the desired setting value.

Parameter	Description
$\square$	Precision priority (Resolution 500)
■ /	Standard Setting (Resolution 200)
$\square$	Response Priority (Resolution 50)

■ Factory setting

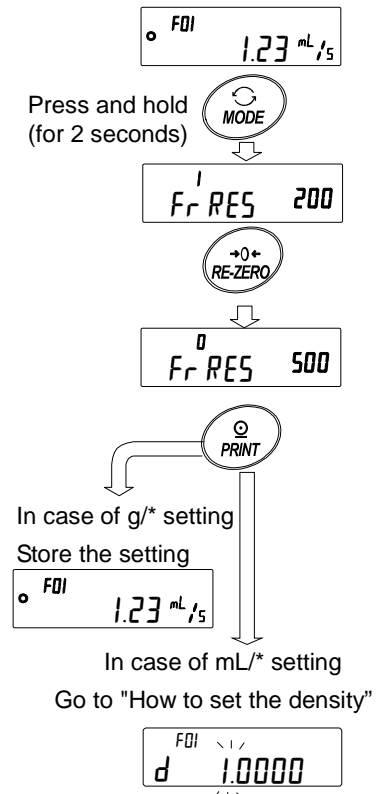

3. Press the **PRINT** key to store.

If the flow rate unit is g / \*, the display returns to weighing display or flow display.

If the flow rate unit is mL / \*, the display transitions to density setting.

Please refer to "How to set the density".

\* Unit of time setting (second(s),minute(m) or hour(h)) is entered in " \* " of "g/\*" and "mL/\*".

### How to set the density

When the setting value of function setting **Frd Unit** is 3, 4, 5, after setting the calculation time or calculation precision, go to density setting display.

Density can be changed by following key operation.

The setting range is 0.0001g/cm<sup>3</sup> to 9.9999g/cm<sup>3</sup>.

- RE-ZERO**(+) key..... Change the number of the blinking digit
- MODE**(-) key ..... Change the number of the blinking digit
- SAMPLE** key ..... Move the blinking digit
- PRINT** key..... Store the set value and return to weighing display.
- CAL** key ..... Return to weighing display without storing the set value.

### Method of reading density number

When flow unit is mL/\*, up to 10 densities can be registered.

To register a new density, read the unconfigured density number and then register according to the procedure of the setting method of calculation time or calculation precision.

Continuing to hold down the **PRINT** key (for 2 seconds) in weighing display displays **d\*.\*\*\*\***.

Blinking **F\*\*** is the current density number and **d\*.\*\*\*\*** is the set density value.

The density number can be changed by following key operation

#### Note

**F\*\*** : The selected density number is entered.

**d\*\*\*\*** : The set density number is entered.

The setting range is F01 ~ F10.

- RE-ZERO**(+) key.... Change density number.
- MODE**(-) key ..... Change density number.
- PRINT** key..... Read the density of the selected density number and return to weighing display.
- CAL** key ..... Return to the weighing display or flow display without reading the density of the selected density number.

### Change display

After returning to the weighing value display after setting to flow mode, the unit is "g" with the **Frd** or **F\*\*** indicator on.

Use the **MODE** key to switch between flow rate display and "g" display. By switching, the total amount and flow rate can be checked.

From the Flow calculation time or Flow calculation precision

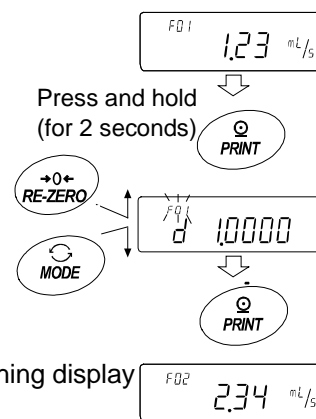
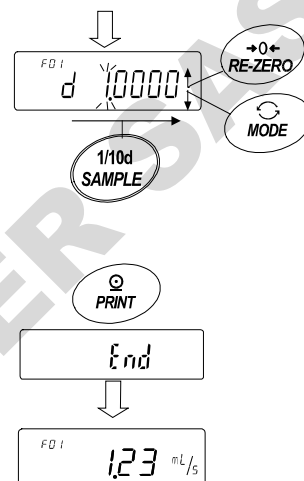

Weighing display **F02** 2.34 mL/s

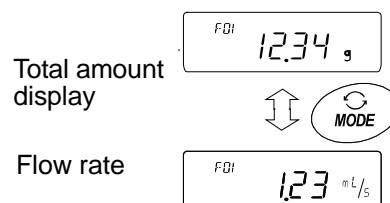

# 16. Gross Net Tare Function

Zero setting and taring can be operated separately, and data output for Gross (total amount), Net (net amount), Tare (tare quantity) becomes possible.

When the gross net tare function is selected, the key operation is changed as follows.

Key	Operation
<b>ON:OFF</b> key	Zero setting (Operate as the <b>ZERO</b> key)
<b>RE-ZERO</b> key	Tare (Operate as the <b>TARE</b> key)

In order to use the Gross Net Tare Function, it is necessary to change the "setting of the Function table".

## 16-1 Preparation Of Gross Net Tare Function

To use this function, enter the Function table as follow, and set "Application Function *AP Fnc*" to "4" in "Application mode *APF*". To return the normal weighing mode (Factory setting), set "Application mode *APF*" to "0".

Please set as follows.

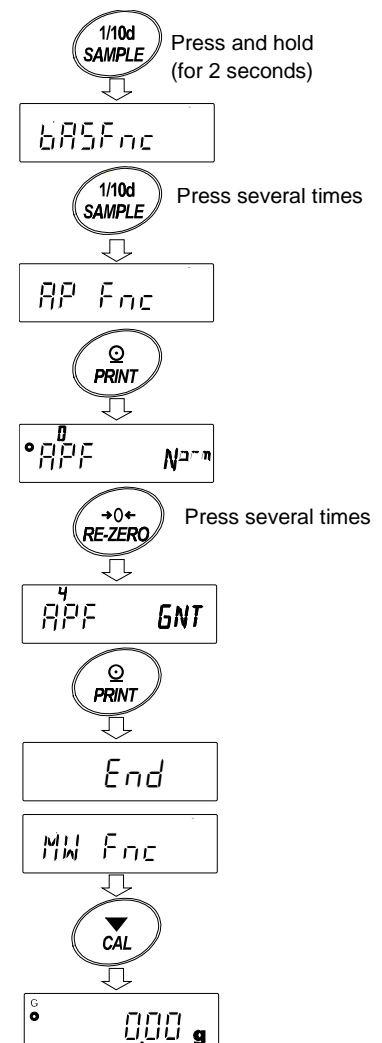

### Setting procedure

1. Press and hold the **SAMPLE** key (for 2 seconds) until **685Fnc** of the function table is displayed, then release the key.
2. Press the **SAMPLE** key several times to display **AP Fnc**.
3. Press the **PRINT** key to display **APF N<sup>0</sup>**.
4. Press the **RE-ZERO** key several times to display **APF GNT**.
5. Press the **PRINT** key to store the setting.
6. Press the **CAL** key to return to the calculating display.



## Key operation

In case of *GNT* setting, operate with the following keys.

Key	Function	Weighing value (gross)	Operation
	Zero setting (ZERO)	Within the zero range *1	Update a zero point and clear a tare value.
		Out of the zero range *1	Do nothing
	TARE	Plus value	Do tare and update a tare value
		Gross zero *2 (Gross zero mark blinking)	Clear a tare value
		Minus value	Do nothing

\*1 "Zero range" means the range where the load is within  $\pm 2\%$  of the weight from the reference zero. For the zero range for each model, refer to "6-1 Basic Operation".

\*2 "Gross zero" means the range where the minimum scale of gross (total amount) is zero in "g". (The state in which the gross zero mark is lit.)

**Note** To turn off the display of balance's display, press the  key (Long press) for about 2 seconds.

## Display

Mark	Description
NET	This lights when the tare is not zero.
G	This lights when the tare is zero.
PT	When the preset tare is set by the PT command, this lights together with the NET mark.
□	This lights when the minimum scale of the gross is in the range of zero in "g".

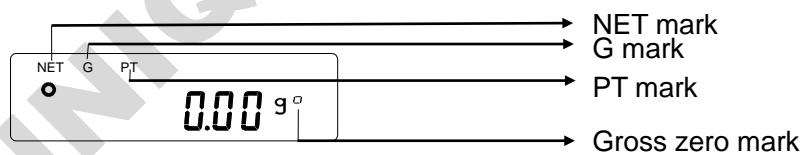

## Output

1. Every time pressing the **PRINT** key, it will output in the order of "NET"(object), "GROSS"(total amount), "TARE"(tare).
2. Only A&D standard format, DP format and CSV format are available as output format.

### Output example (A&D standard format)

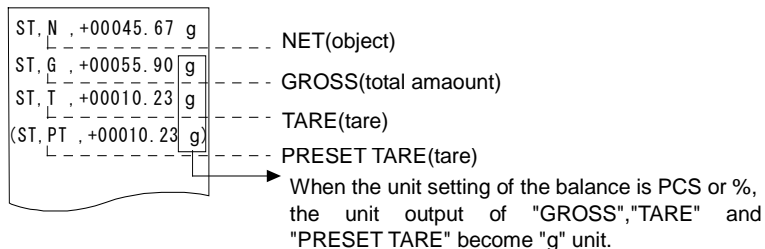

- By using the "UFC function", output connection and order also can be set.  
For the "UFC function", please refer to "Communication manual" which can be downloaded from the A&D website (<https://www.aandd.jp>).

## 16-2 Example Of Using The Gross Net Tare Function

1. After setting the gross net tare function, press the **ON:OFF** key when nothing is on the weighing pan. "G" will be displayed on the display.
2. Place the container to be tared on the weighing pan.
3. Press the **RE-ZERO** key to display **NET 0.00 g**, the tare value is set (updated). "NET" is displayed on the display.
4. Place the object.
5. Press the **PRINT** key, it will output in the order of "NET"(object), "GROSS"(total amount), "TARE"(tare).
- 6 Remove anything on the weighing pan and press the **ON:OFF** key to return to the "1".

To continue weighing without changing the tare value, remove the object only, place the next weighing object and press the **PRINT** key to continue outputting.

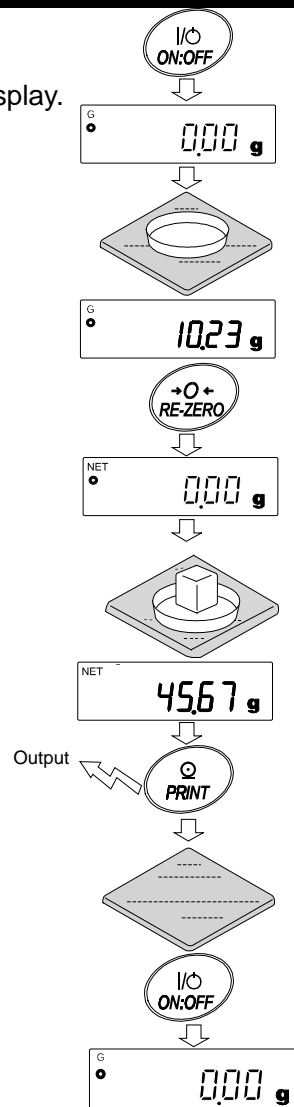

# 17. Minimum Weighing Warning Function

The minimum weighing value is the minimum necessary amount of sample to be used for correctly performing quantitatively performing quantitative analysis, taking into consideration measurement error of the balance.

If the amount of sample is too small, the proportion of the measurement error in the measured value increases accordingly, and the reliability of the analysis result may drop.

By using the minimum weighing warning function, it is possible to judge at a glance whether the amount of sample meets the set minimum weight value. This function can be used only in "g" mode.

"*M,N*" is displayed at the top of the unit part when in use.

When the amount of sample is less than the set minimum weighing value, the "*M,N*" indication flashes.

When the amount of sample reaches the minimum weighing value or more, the "*M,N*" indicator will turn off

The minimum weighing value can be changed from the function setting. The factory setting is 0 g.

If the set value is 0 g, no warning will be displayed even if the minimum weighing warning function is ON (*MW-CP 1* or *2*). Also, a value greater than weighing capacity cannot be set as minimum weighing value.

There are two kinds of warning display as follows

"Excluding near zero" MW-CP E×0

"Including near zero" MW-CP IN0

Near zero is within ± 10 digits of 0 g.

## 17-1 Comparing the minimum weighing value

### Setting procedure

1. Hold down the SAMPLE key to display the function setting bASFnC.
2. Press the SAMPLE key several times to display MWFnC.
3. Press the PRINT key.
4. MWCP will be displayed. Press the RE-ZERO key to change the display from MW-CP OFF to MW-CP E×0 (excluding near zero) or MW-CP IN0 (including near zero).
5. To change the setting of the minimum weighing value, proceed to 6. When not changing the minimum weighing value, press the CAL key to return to weighing mode.
6. Press the SAMPLE key to display MW.  
(As following procedure, set the minimum weighing value after confirming the balance software version.)

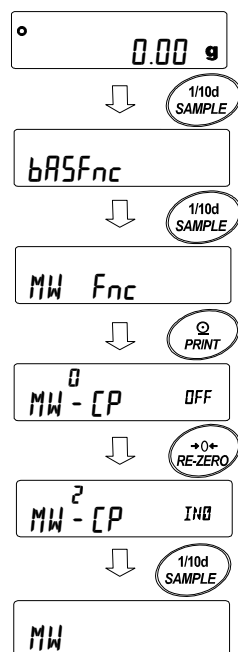

## 17-2 Entering and outputting the minimum weighing value

### 17-2-1 Setting from function setting

**【Inputting the setting value directly】**

Continue from “Step 6” in “17-1 Comparing the minimum weighing value”

7. Press the **PRINT** key while **MW** is displayed.

8. At **KEY in** display

- When setting minimum weighing value  
Press the **PRINT** key again and proceed to Step 9.
- When not setting minimum weighing value  
Press the **CAL** key twice to proceed to weighing mode without entering minimum weighing value.

9. Set the minimum weighing value.

Use the following keys to change the minimum weighing value.

**RE-ZERO**(+) key..... Increase a numerical value of the digit being blinked

**MODE**(-) key..... Decrease a numerical value of the digit being blinked

**SAMPLE** key..... Move the digit being blinked

**PRINT** key.....Store a parameter and proceed to next stage.

\* In this time, when **MW-CP** is set to **0**, the balance automatically set it to **1** (except near zero) and enables comparing function of the minimum weighing value.

**CAL** key.....Proceed to next stage without storing the setting value.

10. Press the **CAL** key to return to weighing mode.

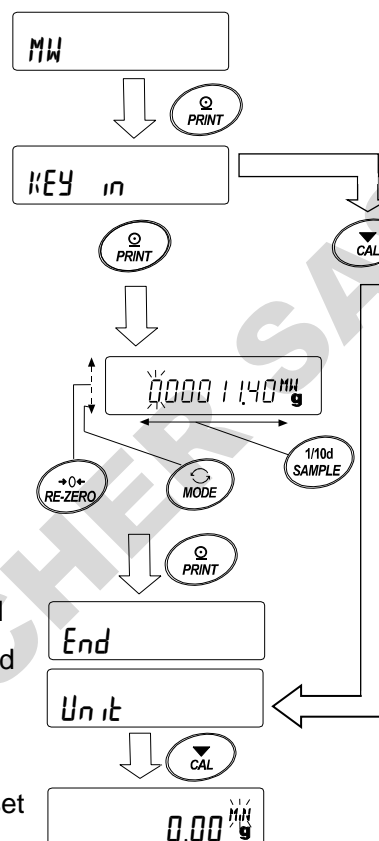



**【Entering from repeatability of external weight】**

Continue from “Step 6” in “17-1 Comparing the minimum weighing value”

7. Press the **PRINT** key while **MW** is displayed to display **KEY in**.

8. Press the **SAMPLE** key to display **Ext MASS**.

9. Press the **PRINT** key to proceed as order

**START** → **READY** → **Weighing mode**.

And display requests a first load for repeatability as

**LOAD**.

10. Place the weight on the weighing pan. Processing indicator (→) illuminates.

11. When display is stabilizing for 2 seconds after blinking processing indicator (→), it shows span value.

12. After that, display shows **REMOVE** in blinking.

13. Processing indicator (→) illuminates after removing the weight from the pan.

14. When display is stabilizing for 2 seconds after blinking processing indicator (→), it shows zero.

15. And **LOAD** is displayed as request for second load of repeatability.

As following procedure, perform repeatability measurement 10 times.

16. After displaying 10th span, display proceeds as order

**REMOVE** → **End** and shows **MW 0.1% 23.20 g** of minimum weighing value.

MW



KEY in



Ext MASS



START

READY

0.00 g

LOAD

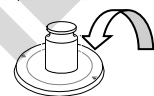

LOAD

Processing indicator illuminates by placing the weight

LOAD

Processing indicator blinks when stabilized

309.56 g

Shows span value at stabilization for 2 seconds.

REMOVE



REMOVE

Processing indicator illuminates by removing the weight

REMOVE

Processing indicator blinks when stabilized

0.00 g

Shows span value at stabilization for 2 seconds.

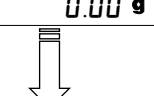

LOAD

309.55 g

Shows 10th span value

REMOVE

End

MW 0.1% 23.20 g

Description of error display

**E** g Over loaded

**-E** g Under loaded

\* When any error described above is resolved, the balance returns to repeatability measurement.

**Error 1** When the balance is in unstable (approx. 20 seconds) during repeatability measurement

Time out (when no operation is made for approx. 2 minutes)

\* After displaying **Error**, the repeatability measurement is forcibly finished and the balance returns to function settings.

17. Repeatability (**SD**) or minimum displaying value (**MW**) can be output by selecting them.

Press the **SAMPLE** key while **MW 23.20 g** is displayed to toggle between minimum weighing value (**MW**) and repeatability (**SD**).

Press the **MODE** key to switch allowable measurement error.

【Minimum weighing value batch output example】

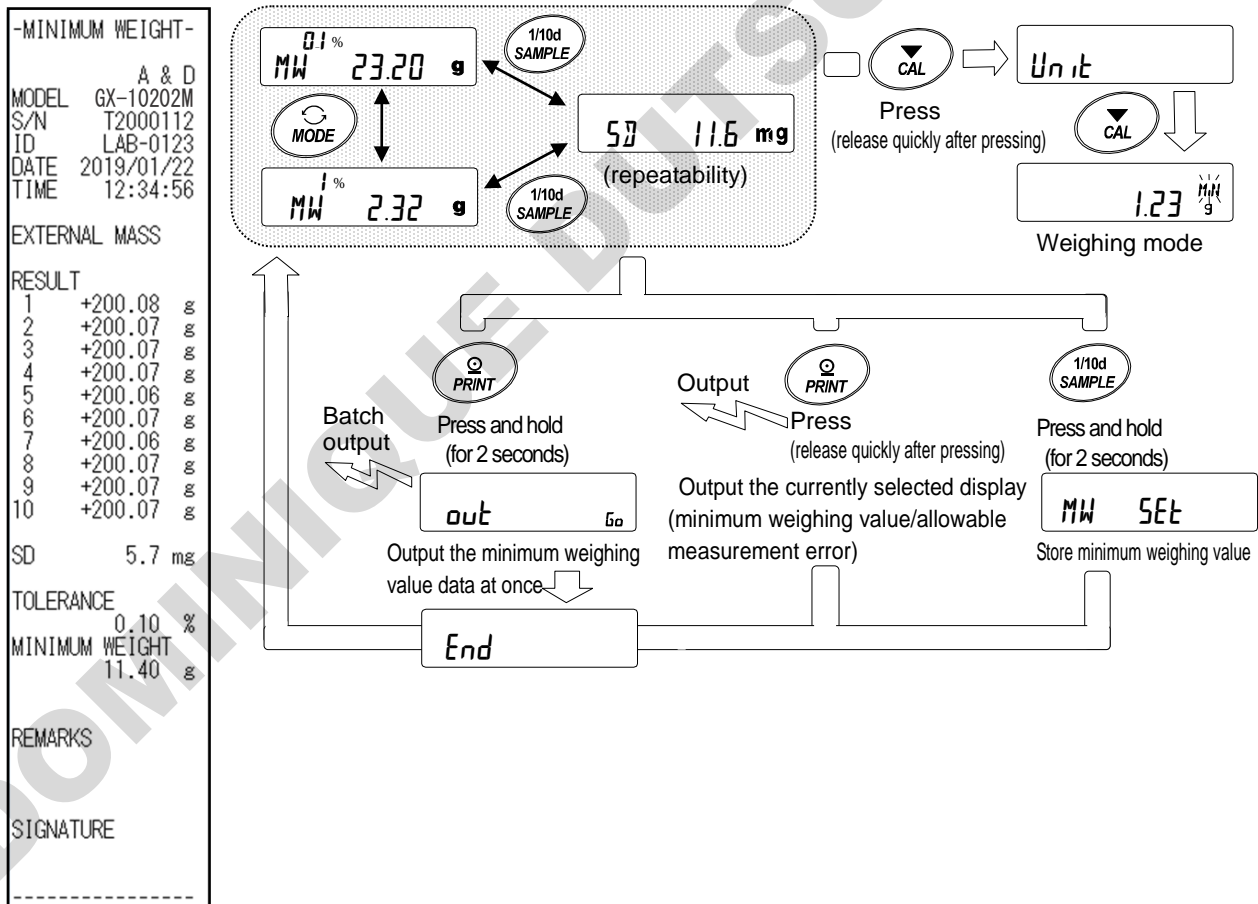

18. Press the **PRINT** key to output a display selected in Step 17 (repeatability (**SD**) or minimum weighing value (**MW**)).

Press and hold the **PRINT** key (for 2 seconds) to output data at once.

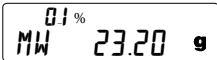
19. After output,  is displayed.

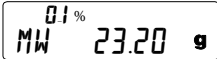
20. Press and hold the **[SAMPLE]** key (for 2 seconds) to store minimum weighing value. Display returns to .

\* In this time, when **MW-CP** is set to **0**, the balance automatically set it to **1** (except near zero) and enables comparing function of the minimum weighing value.

21. Press the **[CAL]** key twice to proceed to weighing mode. Alarm function of minimum weighing value is started.

### 17-2-2 Setting from the weighing mode

1. Press the **[MODE]** key in weighing mode.

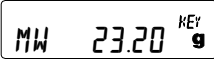
After confirming  display, press the **[PRINT]** key.

2. **KEY in** is displayed.

As following procedure, continue to Step 8 of **【Inputting the setting value directly】** or Step 8 of **【Entering from repeatability of external weight】** in “17-2-1 Setting from function setting” to set minimum weighing value.

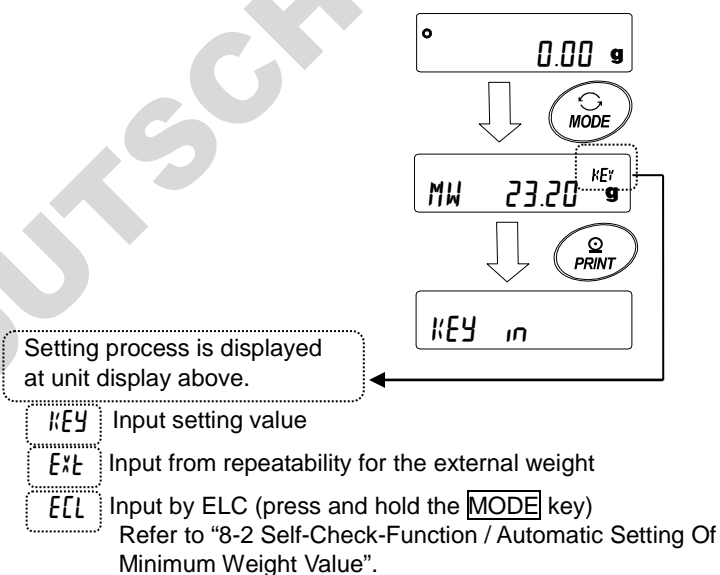

### 17-2-3 Outputting the setting value at once

The minimum weighing value set currently and results for repeatability can be output at once.

1. Press and hold the **[PRINT]** key (for 2 seconds) while **KEY in** or **EXT MASS** is displayed.

2. Press the **[REZERO]** key to toggle between “No” or “Go” on **out** display.

Select “Go” and press the **[PRINT]** key. Setting values are outputted at once.

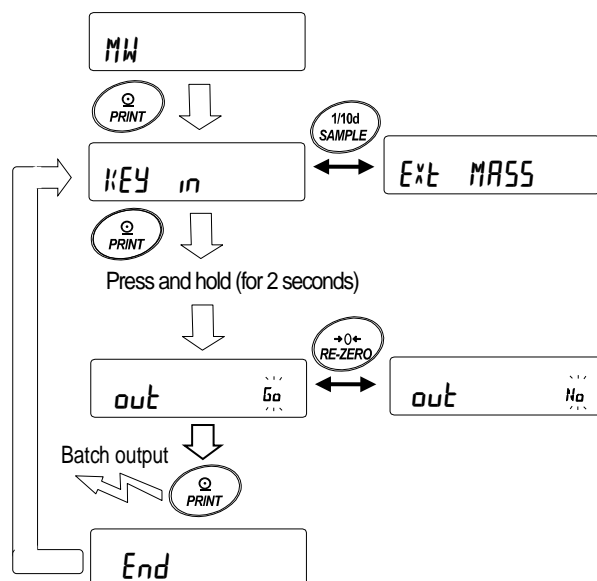

3. After finishing output at once, display shows `End` and returns to `KEY in` or `Ext MASS`.

**[Batch output example of minimum weighing value set currently]**

A type of output vary depending on how to set minimum weighing value.

Setting example with `KEY in`

```

-MINIMUM WEIGHT-
      A & D
MODEL  GX-10202M
S/N    T2000112
ID     LAB-0123
DATE   2019/01/22
TIME   12:12:34

KEY INPUT

MINIMUM WEIGHT
      11.40 g

REMARKS

SIGNATURE
-----
    
```

Setting example with `Ext MASS`

```

-MINIMUM WEIGHT-
      A & D
MODEL  GX-10202M
S/N    T2000112
ID     LAB-0123
DATE   2019/01/22
TIME   12:34:56

EXTERNAL MASS

RESULT
 1  +200.08 g
 2  +200.07 g
 3  +200.07 g
 4  +200.07 g
 5  +200.06 g
 6  +200.07 g
 7  +200.06 g
 8  +200.07 g
 9  +200.07 g
10  +200.07 g

SD  0.0057 g

TOLERANCE
      0.10 %
MINIMUM WEIGHT
      11.40 g

REMARKS

SIGNATURE
-----
    
```

Setting example with ECL

```

-MINIMUM WEIGHT-
      A & D
MODEL  GX-10202M
S/N    T2000112
ID     LAB-0123
DATE   2019/01/22
TIME   12:51:55

ECL

RESULT
 1  +20.07 g
 2  +20.06 g
 3  +20.06 g
 4  +20.06 g
 5  +20.05 g
 6  +20.06 g
 7  +20.05 g
 8  +20.06 g
 9  +20.06 g
10  +20.06 g

SD  0.0057 g

TOLERANCE
      0.10 %
MINIMUM WEIGHT
      11.40 g

REMARKS

SIGNATURE
-----
    
```

# 18.Underhook

The underhook can be used for weighing large samples, magnetic materials or for measuring density. The built-in underhook is revealed by removing the cover plates on the bottom of the balance. Use the underhook as shown below.

## Caution

- Do not apply excessive force to the underhook.
- When not in use, attach the cover plate to prevent dust from getting into the balance.

 The weighing pan, pan support and draft gate fall off, when turning over the balance. Remove them first.

1. Remove the draft gate.
2. Remove the weighing pan and pan support.
3. Turn over the balance.
4. Remove the cover plates.
5. Hang from the underhook.

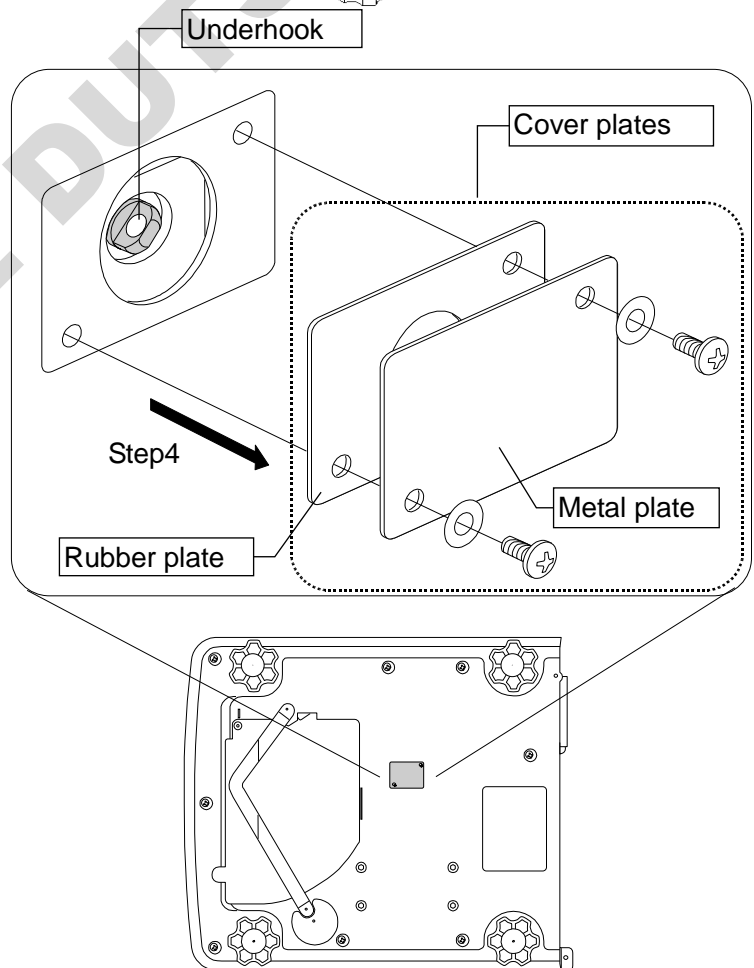
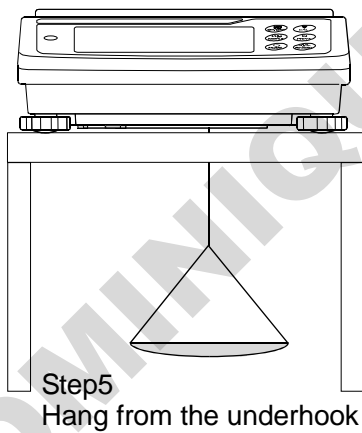
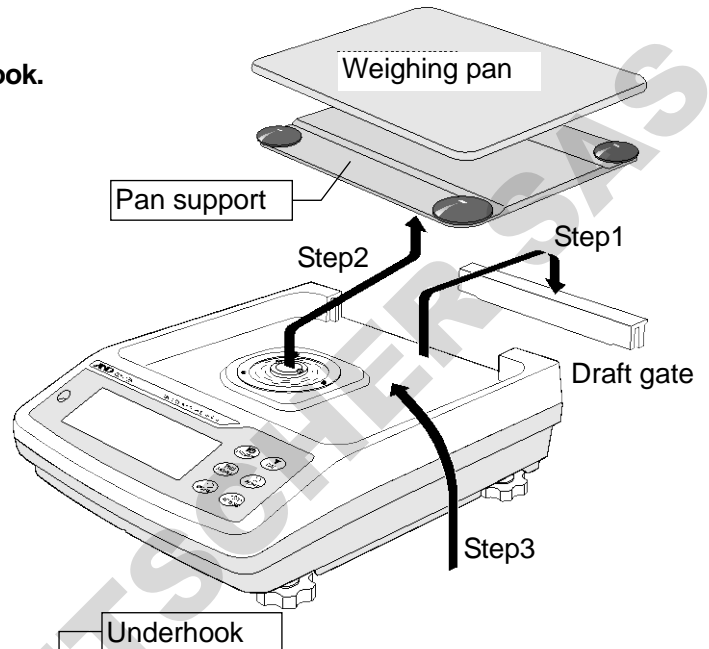

# 19. Programmable-Unit

This is a programmable unit conversion function. It multiplies the weighing data in grams by an arbitrary coefficient set in the function table and displays the result.

The coefficient must be within the range between the minimum and maximum shown below. If the coefficient set is beyond the range, an error is displayed and the balance returns to the coefficient setting mode, prompting to enter an appropriate value. A coefficient of 1 was set at the factory.

Model	Minimum coefficient	Maximum coefficient
GX/GF-8202M/8202MD/10202M	0.000001	100
GX/GF-12001M/22001M/32001M/32001MD		10

## Operation

1. Press and hold the **[SAMPLE]** key until **bASFnC** of the function table is displayed.
2. Press the **[SAMPLE]** key several times to display **MLt**.
3. Press the **[PRINT]** key. The balance enters the mode to confirm or set the coefficient.

## Confirming the coefficient

4. The current coefficient is displayed with the first digit blinking.
  - When it is not to be changed, press the **[CAL]** key and proceed to step 6.
  - When it is to be changed, press the **[RE-ZERO]** key and proceed to step 5.

## Setting the coefficient

5. Set the coefficient using the following keys.

**[SAMPLE]** key ..... To select a digit to change the value. The selected digit blinks.

**[RE-ZERO]** key ..... To change the value.

**[MODE]** key ..... To change the decimal point position.

Each time the switch is pressed, the decimal point position changes as follows:

→ 0.000001 → 00.00001 → ... → 000000.1 → 0000001

**[PRINT]** key ..... To store the new setting, display **End** and go to step 6.

**[CAL]** key ..... To cancel the new setting and go to step 6.

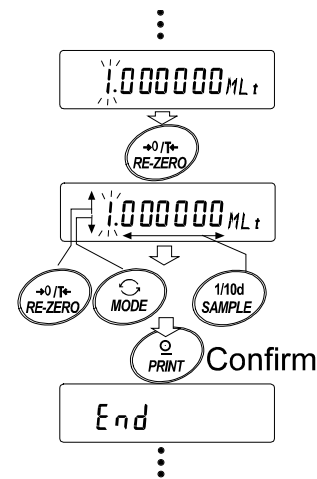

## Quitting the operation

6. The balance displays **Unit**. Press the **[CAL]** key to exit the programmable-unit function and return to the weighing mode.

## Using the function

Press the **[MODE]** key to select the programmable-unit (no display on the unit section). Perform weighing as described in "6-1 Basic Operation (Gram Mode)". After weighing, the balance displays the result (weighing data in grams x coefficient).

# 20. Density Measurement

The balance is equipped with a density mode. It calculates the density of a solid using the mass value of a sample in air and the mass value in liquid.

## Note

- The density mode was not selected for use when the balance was shipped from the factory. To use the mode, change the function table and activate the density mode "15". Refer to "5-2.Storing Units".
- Minimum display is fixed while density mode.

## Formula to obtain the density

### 1. Density of solid

It can be obtained from the weight of the sample in air, the weight in the liquid, and the density of the liquid.

$$\rho = \frac{A}{A-B} \times \rho_0$$

$\rho$  : Density of a sample      A: Mass value of a sample in air  
 $\rho_0$  : Density of a liquid      B: Mass value of a sample in liquid

### 2. Density of liquid

Weight in air, weight in liquid and volume of float can be obtained using a float of a known.

$$\rho = \frac{A-B}{V}$$

$\rho$  : Density of a sample      A: Mass value of a sample in air  
 $V$  : Volume of float      B: Mass value of a sample in liquid

## ( 1 ) Prior to measurement: Changing the function table

Prior to measurement, change the function table as follows:

### 1. Register the density mode.

Density mode cannot be used at the factory setting.

Please refer to "5-2.Storing Units" and register the gravimeter mode ( 15 ).

Density mode is selected as one of the units with the MODE key.

### 2. Select whether the object to be measured is solid or liquid. (Function setting $d5 Fnc$ , $d5$ )

### 3. In the case of solid density measurement, select a method of inputting the density of liquid (function setting $d5 Fnc$ , $Ldin$ )

Density of liquid can be set by water temperature input or direct input of density, or input by the following function setting can be selected.

### 4. To start the measurement, display the weighing display.

Press the MODE key to display the specific gravity measurement display.

## Note

- The following density function (  $d5 Fnc$  ) is not displayed in the function settings unless density mode is enabled. First, perform the "Register the density mode" operation with the unit setting (  $Unit$  ) of the function setting. When density mode is activated, " $d5 Fnc$ " appears next to " $Unit$ ". For how to change the function setting, refer to "11. Function table".

Class	Item and parameter	Description
$d5 Fnc$ Density function	$Ldin$	<ul style="list-style-type: none"> <li>▪ <span style="border: 1px solid black; padding: 0 2px;">0</span> Input water temperature</li> <li>▪ <span style="border: 1px solid black; padding: 0 2px;">1</span> Input density directly</li> </ul>
	$d5$	<ul style="list-style-type: none"> <li>▪ <span style="border: 1px solid black; padding: 0 2px;">0</span> Density measurement of solid</li> <li>▪ <span style="border: 1px solid black; padding: 0 2px;">1</span> Density measurement of liquid</li> </ul>
	Measurement object select	

▪ Factory setting

## ( 2 ) Method of measuring density (specific gravity) of solid (function setting $d5 0$ )

### Note

- Re-set the density of the liquid with "(3) Entering the density of a liquid" as necessary, such as when the temperature of the liquid changes during measurement or when changing the type of liquid.
- In the density display, the 3 digits after the decimal point are fixed. The minimum display cannot be changed by pressing the **[SAMPLE]** key. Density measurement displays the density fixed by measuring the weight in air and measuring the weight in liquid.

The relationship between each state and display is as follows.

### Setting procedure

1. Check the weight measurement mode in air (g lights, blink ◀ ).  
Press the **[RE-ZERO]** key to display zero without placing anything on the weighing pan.
2. Place the sample on the weighing pan in air and wait for the display to stabilize. If outputting the mass of the sample, press the **[PRINT]** key.  
Next, press the **[SAMPLE]** key to fix the weight in air, and move to the weight measurement mode in liquid (g lights, blink ◀ ).
3. Transfer the sample from the weighing pan in air to the weighing pan in liquid and wait for the display to stabilize. If outputting the mass of the sample, press the **[PRINT]** key.  
Next, press the **[SAMPLE]** key to fix the weight in liquid and shift to the density input mode (g turned off, lights ◀ ).
4. Enter the density of the liquid.  
Refer to "(3) Entering the density of a liquid" and set the density.  
Next, press the **[PRINT]** key to enter the density mode. (g turns off, lights ◀ ).
5. If outputting the density, press the **[PRINT]** key.  
If measuring another sample, press the **[SAMPLE]** key and start with the weighing mode in air. The density unit is " $d5$ ".
6. Re-set the density of the liquid with "(3) Entering the density of a liquid" as necessary, such as when the temperature of the liquid changes during measurement or when changing the type of liquid.
7. Press the **[MODE]** key to enter another weighing mode.

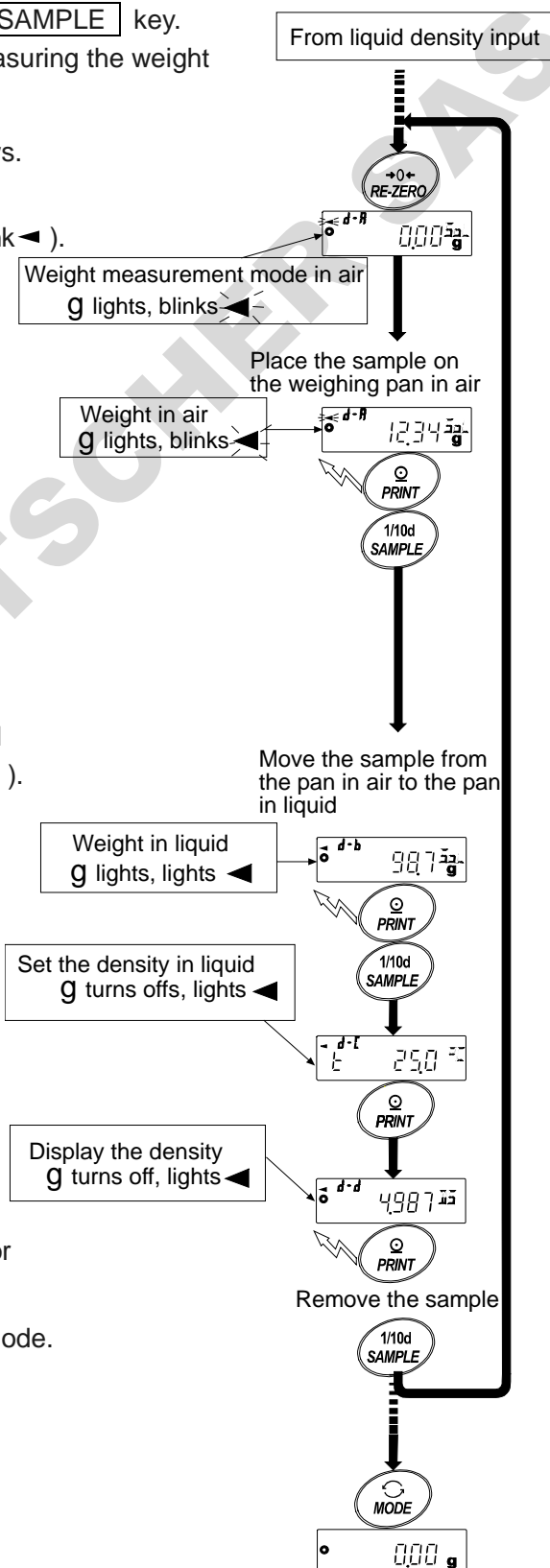



### ( 3 ) Entering the density of a liquid

Two ways to set the density of a liquid are available in the function table, "Liquid density input ( $Ld\ in$ )" by entering the water temperature or by entering the density directly.

Entering the water temperature ( $Ld\ in\ T$ )

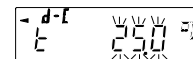

The water temperature currently set (unit:°C, factory setting : 25°C) is displayed.

Use the following keys to change the value. Setting range is 0.0°C to 99.9°C, in increments of 0.1°C. Refer to the following matrix the " The relation between the water temperature and density".

**RE-ZERO** (+) key .....The key to increase the temperature by one degree.  
(0 is displayed after 9)

**MODE** (–) key .....The key to decrease the temperature by one degree.  
(9 is displayed after 0)

**SAMPLE** key .....Move the blinking digit.

**PRINT** key .....The key to store new water temperature and return to the density mode.(Proceed to Step 5)

**CAL** key .....The key to cancel the change and return to the density mode.  
(Proceed to Step 5)

### The relation between the water temperature and density

°C	+0	+1	+2	+3	+4	+5	+6	+7	+8	+9
0	0.99984	0.99990	0.99994	0.99996	0.99997	0.99996	0.99994	0.99990	0.99985	0.99978
10	0.99970	0.99961	0.99949	0.99938	0.99924	0.99910	0.99894	0.99877	0.99860	0.99841
20	0.99820	0.99799	0.99777	0.99754	0.99730	0.99704	0.99678	0.99651	0.99623	0.99594
30	0.99565	0.99534	0.99503	0.99470	0.99437	0.99403	0.99368	0.99333	0.99297	0.99259
40	0.99222	0.99183	0.99144	0.99104	0.99063	0.99021	0.98979	0.98936	0.98893	0.98849

g/cm<sup>3</sup>

### Entering the density directly ( $Ld\ in\ I$ ) .

The density currently set (unit : g / cm<sup>3</sup>, factory setting : 1.0000g / cm<sup>3</sup>) is displayed.

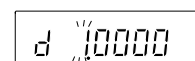

Use the following keys to change the value.

The range to set the density is 0.0000g / cm<sup>3</sup> to 1.9999g / cm<sup>3</sup>.

If it is input beyond the settable range value, **Error E** is displayed and the display return to the input display.

**RE-ZERO** (+) key .....The key to set the value of the blinking digit .(Next to 9 will be 0.)

**MODE** (–) key .....The key to select the blinking digit to change the value.(Next to 0 will be 9.)

**SAMPLE** key .....Move the blinking digit.

**PRINT** key .....The key to store the change and return to the density mode. (Proceed to Step 5.)

**CAL** key .....The key to cancel the change and return to the density mode. (Proceed to Step 5.)

( 4 ) Measuring the density of a liquid (Function table  $d_5$  1 )

Density display is 3 decimal places. Minimum display can not change with the **[SAMPLE]** key.

Density is displayed after "Mass measurement in air" and "Mass measurement in liquid"

The procedure of each measurements is as follows:

**Measuring procedure**

1. Enter the density mode that "g (gram)" is displayed and the processing indicator (◀) blinks. Place nothing on both pan and press the **[RE-ZERO]** key to display zero.
2. Place the float on the pan in air and wait until the display is stabilized.  
If the weight value is stored or output, press the **[PRINT]** key to store it after a stable weight value is displayed.  
Press the **[SAMPLE]** key to decide the weight value in air and proceed to next step. (g lights, ▶ blinks)
3. Place the liquid to measure the density of in the beaker and sink the float.  
At this time, adjust so that the float is about 10mm below the liquid level.
4. Wait until the display is stabilized.  
If the weight value is stored or output, press the **[PRINT]** key to store it after a stable weight value is displayed. Press the **[SAMPLE]** key to decide the weight value in liquid and proceed to next step. (g turned off,  $\overline{cm^3}$  lights, ▶ lights)
5. Enter the volume of the float.  
Refer to "(5) Entering the volume of the float" and enter.  
Then press the **[PRINT]** key to return to the density mode.
6. If the density value is stored or output, press the **[PRINT]** key to store it. If the other sample is measured, press the **[SAMPLE]** key, and start from measurement of weighing mode in the air. The density unit is "  $\overline{15}$  ".
7. Press the **[MODE]** key to proceed to other modes.

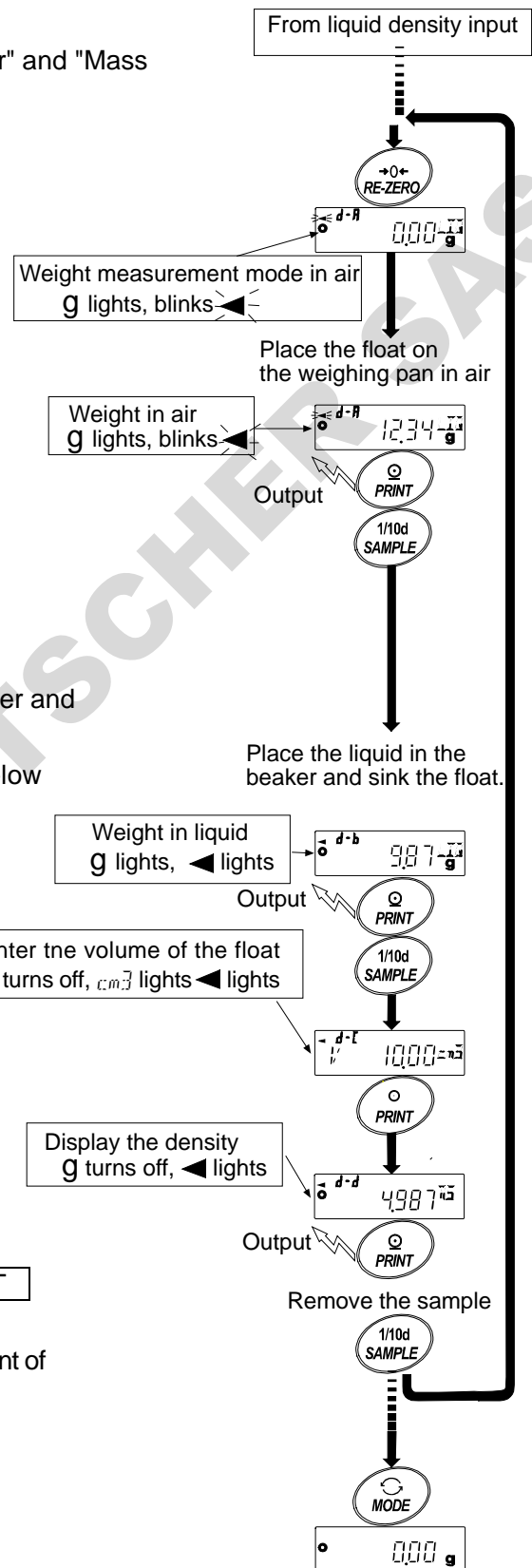

## ( 5 ) Entering the volume of the float

The volume of the float that is currently set is displayed. (Factory setting is 10.00 c m<sup>3</sup>)

Change the setting value as follows.

The setting range is 0.01 c m<sup>3</sup> to 99.99 c m<sup>3</sup>, every 0.01 c m<sup>3</sup>.

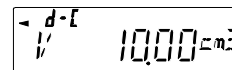

**RE-ZERO** (+) Key .....The key to set the value of the blinking digit .

(Next to 9 will be 0.)

**MODE** (–) key .....The key to select the blinking digit to change the value.

(Next to 0 will be 9.)

**SAMPLE** key .....Move the blinking digit.

**PRINT** key .....The key to store the change and return to the density mode. (Proceed to Step 5.)

**CAL** key .....The key to cancel the change and return to the density mode. (Proceed to Step 5.)

## 21.Password Lock Function

By using the password lock function, it is possible to limit the usage and functions of the balance. The function is effective for preventing alteration of date/time setting and preventing internal setting changes by the user.

The password is set with four keys [MODE], [SAMPLE], [PRINT] and [RE-ZERO] keys in four digits (4 x 4 x 4 x 4 = 256 outcomes) .

At factory setting, the password function is disabled.

Enabling / disabling the password function and registering the password are performed in the Function table.

Three types of settings are possible depending on the "Lock" setting of the Function Table "Password lock (PASS<sub>wd</sub>)".

Lock 0	No password lock function
Lock 1	Request password input at the start of weighing
Lock 2	To change the setting, login is required with the administrator's password.

Lock 0 (No password lock function)

The password lock function is not used.

Anyone can perform weighing work. In addition, all functions can be used and setting changes are also possible.

Lock 1 (Request password input at the start of weighing)

An administrator (ADMIN) can limit the users of the balance by setting individual passwords.

(The password input is required at the start of weighing with the [ON:OFF] key.)

The balance cannot be in weighing state unless you enter the correct password.

There are two login levels: Administrator (ADMIN) and user (USER 01 to 10)

Administrator (ADMIN)	All functions and settings can be used. Passwords for 10 users can be set individually.
User (USER 01 to 10)	Initialization and setting changes are restricted (including clock).

Lock 2 (To change the setting, login is required with the administrator's password.)

Anyone can perform weighing work, and initialization and setting changes can be restricted (including clock).

(Password input is not requested when weighing starts with the [ON:OFF] key.)

There are two levels of login level :Administrator (ADMIN) and user (GUEST)

Administrator (ADMIN)	All functions and settings can be used.
Guest (GUEST)	Initialization and changing setting is restricted.(including clock)

When weighing is started with the [ON:OFF] key while pressing the [CAL] key when the display is off, the password of the administrator (ADMIN) is requested.

## Items that are limited by login level

Login level	Weighing		
	Password input at weighing start	Calibration	Change the function setting*5
Administrator (ADMIN)	Necessary	Possible	Possible
User (USER 01 to 10)		Impossible *6	Impossible
Guest (GUEST)	Unnecessary		

\*5 Response adjustment, settings of the minimum weighing value, confirmation of the repeatability using the internal weight, function switch and initialization and function table (date and time setting)

\*6 The administrator (ADMIN) can set this to prohibited as shown in "10-1 Permit Or Inhibit".

## 21-1 Enable Password Lock Function

By the password function (PASSWD) of the Function table, the password function can be switched between "Invalid(OFF) / Valid(ALL) / Valid(Fnc)".

- In the weighing mode, press and hold the **SAMPLE** key (for 2 seconds) to display **bASFnC**.
- Press the **SAMPLE** key several times to display **PASSwd**.
- Press the **PRINT** key to display **Lock OFF**.  
(To cancel, press the **CAL** key.)
- Press the **RE-ZERO** key to display **Lock ALL**.  
(Press the **RE-ZERO** key again to display **Lock Fnc**.)
- Press the **PRINT** key to display **SURE: YES**.  
("No" blinking while "No" selected.)
- Press the **RE-ZERO** key to switch YES / No.
- Display **SURE: YES No**. (YES blinking when selected YES.)
- Press the **PRINT** key while YES is selected to enable the password lock function.  
(With **Lock I**, password input is requested when the display is ON).
- PASSNo.** is displayed. To register (change) the password, proceed to "4" on the "21-4. Registering Password (Changing)". If you will not register, press the **CAL** key twice to return to the weighing display.

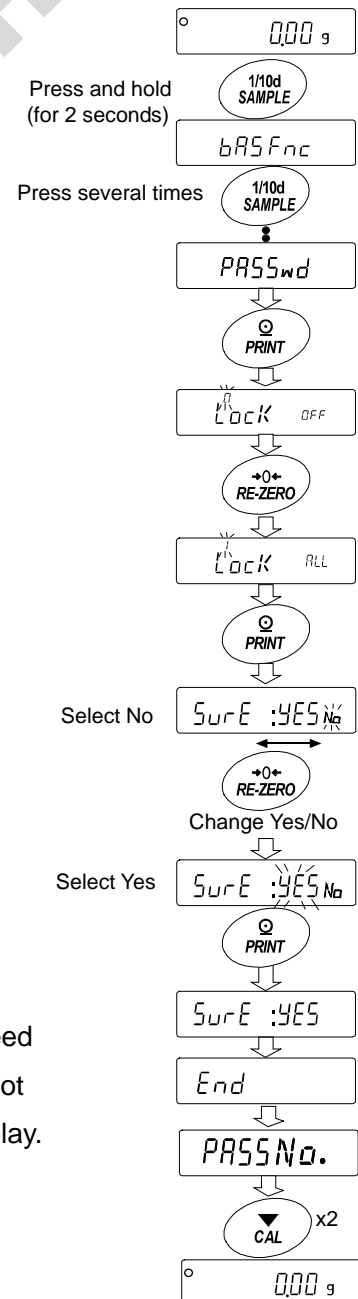

## 21-2 How To Input The Password At The Start Of Weighing

### In case of Lock 1

1. Press the **ON:OFF** key while the display off.
2. After display **PASSword**, it becomes password input display **---- PW**.

3. Input 4 digits password using the following keys.  
The balance will turn automatically after no operation for ten minutes.

**MODE** key.....Character **M**

**SAMPLE** key.....Character **S**

**PRINT** key .....Character **P**

**RE-ZERO** key .....Character **Z**

**CAL** key.....Back key

4. If the password is correct, the login level will be displayed, the weighing will be displayed after all lamps are illuminated. After entering the administrator's password, log in as an administrator.

(At factory settings, the password is set to **7777** by **RE-ZERO** key input 4 times at the administrator level.)

If the password is incorrect, the buzzer sounds 3 times,

**FAIL** will display and the display will turn off.

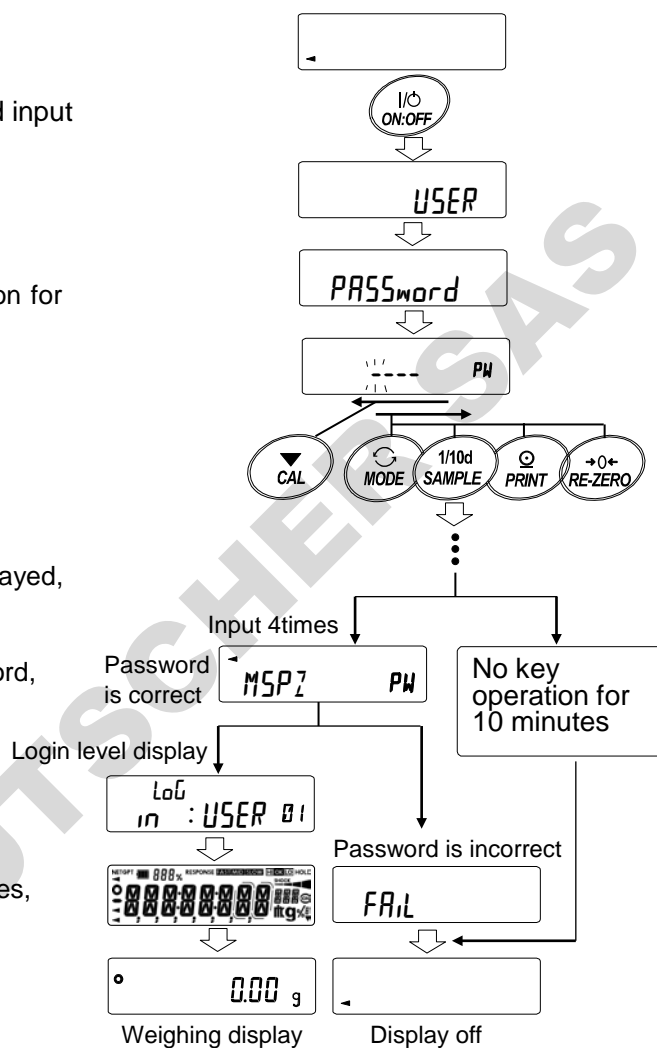

### In case of Lock 2

1. Press the **ON:OFF** key while the display off.
2. After **LoG in GUEST** displayed, return to the weighing display.

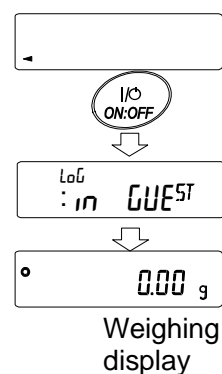

**When logging in as administrator (ADMIN.) (Lock 1 or Lock 2)**

1. Press the **ON:OFF** key with holding **CAL** key while the display off.
2. Input the 4 digits password using the following keys.  
The balance will turn automatically after no operation for ten minutes.

<b>MODE</b> key	.....Character	<b>M</b>
<b>SAMPLE</b> key	.....Character	<b>S</b>
<b>PRINT</b> key	.....Character	<b>P</b>
<b>RE-ZERO</b> key	.....Character	<b>Z</b>
<b>CAL</b> key	.....Back key	

3. If the password is correct, the login level will be displayed, the weighing will be displayed after all lamps are displayed.  
(At factory settings, the password is set with **7777** of **RE-ZERO** key input 4 times at the administrator level.)  
If the password is incorrect, the buzzer sounds 3 times in **FAIL** display and the display turns off.

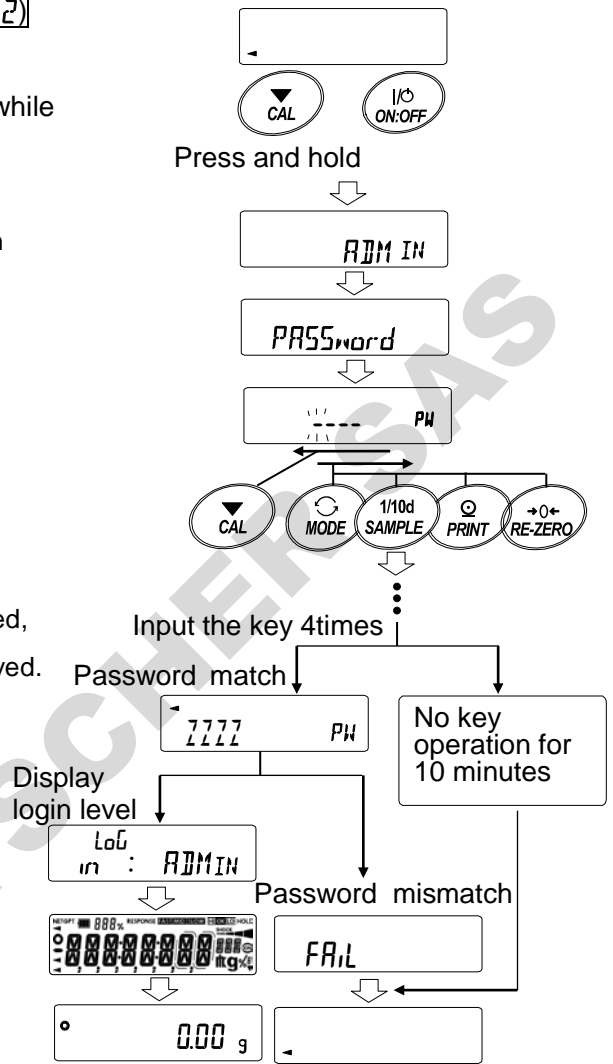

### 21-3 How To Logout

Turn off the display by pressing the **ON:OFF** key to log out.  
If set to **Lock 1**, the password will be requested again when switching the display from off to the weighing mode.

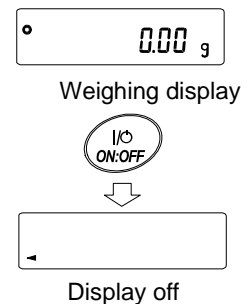

## 21-4 Registering Password (Changing)

The password can be changed at "Password ( *PASSNo.* )" of the Function Table.

1. Press and hold the **SAMPLE** key (for 2 seconds) in the weighing mode. **bASFnC** is displayed.
2. Press the **SAMPLE** key several times until **PASSwd** is displayed.
3. Press the **PRINT** key to display **Lock**.
4. Press the **SAMPLE** key to display **PASSNo.**
5. Press the **PRINT** key to display **ADMIN**.
6. Press the **SAMPLE** key to change the login level **ADMIN / USER 01~10**.

If the password is already registered at the login level, the stability mark  $\circ$  is lit. (changeable)

7. Press the **PRINT** key to change the password.  
Refer to "21-5. Changing Password".

### Note

- Turn off the display by pressing the **ON:OFF** key to log out.
- If set to **Lock 2**, the **ADMIN** password is required when logging in as an administrator.  
Password registration of **USER 01~10** is unnecessary.

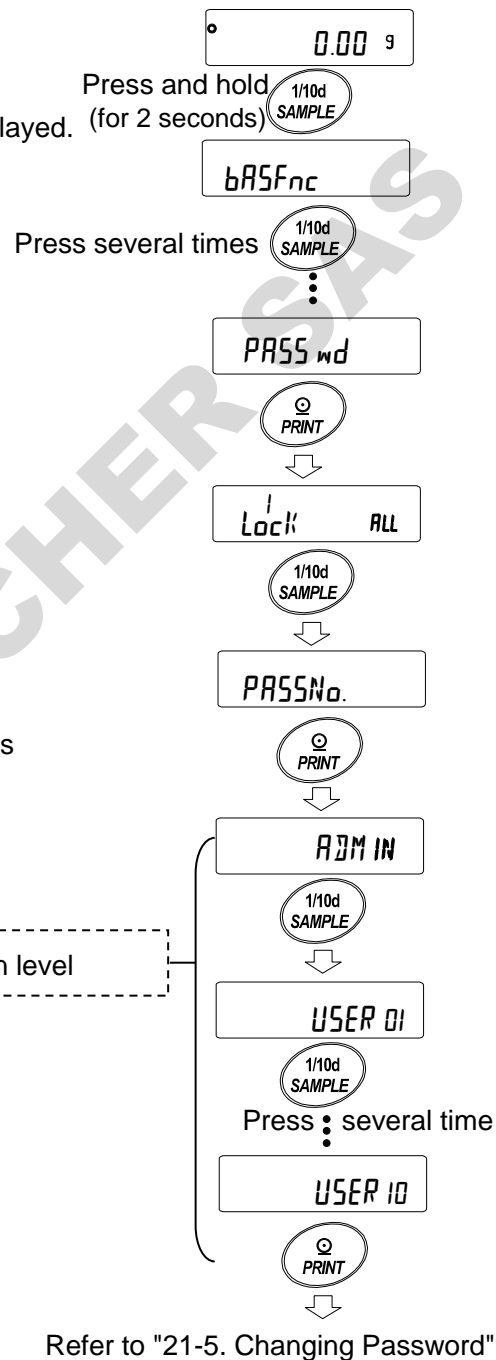



## 21-5 Changing Password

1. Refer to "21-4. Registering Password (Changing)" and display the login level you want to change the password on.
2. Press the **PRINT** key to display the current password.  
At factory settings, the password is **7777**.  
(the **RE-ZERO** key, 4 times)
3. Set the new password using the following keys.  
The balance will turn automatically after no operation for ten minutes.  

<b>MODE</b> key	.....	Character	<b>M</b>
<b>SAMPLE</b> key	.....	Character	<b>S</b>
<b>PRINT</b> key	.....	Character	<b>P</b>
<b>RE-ZERO</b> key	...	Character	<b>Z</b>
<b>CAL</b> key	.....	Back key	
<b>CAL</b> key (long press)	..	Delete password	

  
(Refer to "21-6. How To Delete The Password USER 01~10")
4. Input 4 characters of the new password using these keys.
5. The balance displays **SUR E : YES No** where "No" is blinking when "No" is selected.  
(Press the **CAL** key to return to the 4th character input.)
6. Press the **RE-ZERO** key to display **SUR E : YES No** where "YES" is blinking when "YES" is selected.
7. Press the **PRINT** key to store the new password when "YES" is selected.
8. When the setting is completed, the next level is displayed. To continue the setting, set it from "6".  
To end the setting, press the **CAL** key 3 times to return to the weighing display.

### Note

- If you forget your password, the balance can not be used. Please record and keep the password you registered.
- The password that is already registered by the administrator (**ADMIN**) cannot be registered by the user (**USER 01~10**).

Refer to "21-4. Registering Password (Changing)"

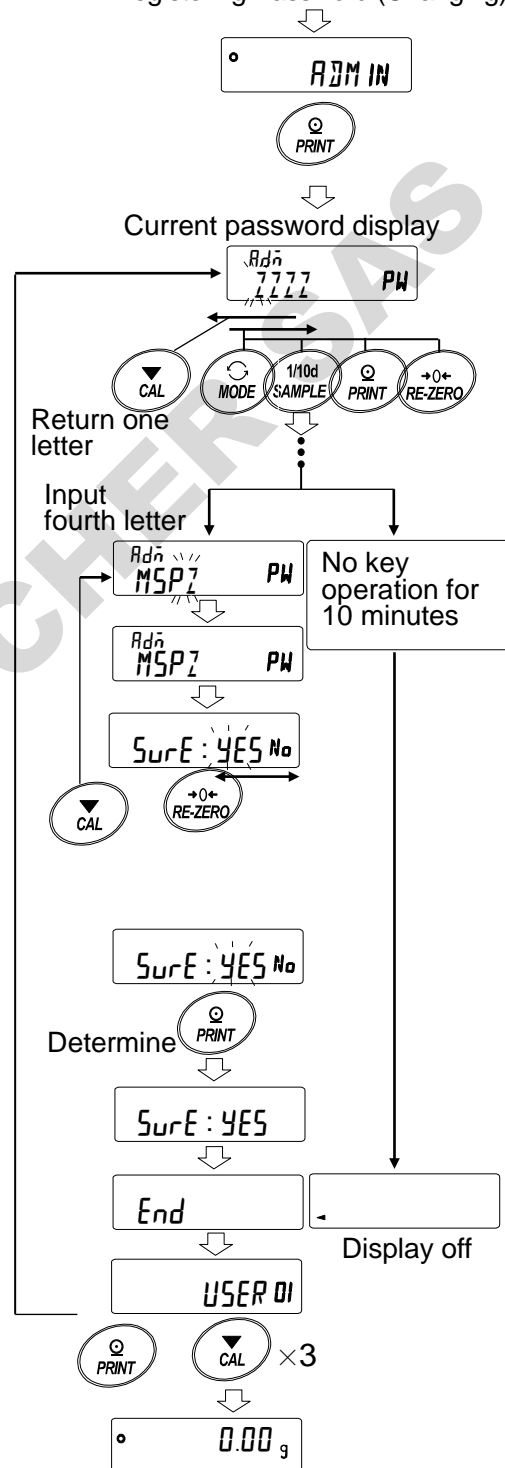

## 21-6 How To Delete The Password (USER 01~10)

1. Refer to "21-5. Changing Password" and select the user (USER 01~10) and display the Password input screen.
2. Hold down the **CAL** key (for 2 seconds) when setting the password and display **CLEAR** (blink).
3. Press the **PRINT** key to display **CLEAR No**.
4. Press the **RE-ZERO** to change **Go/No**.
5. Press the **PRINT** when **CLEAR Go** to display **End** and delete the password.

Refer to "21-5.Changeing Password"

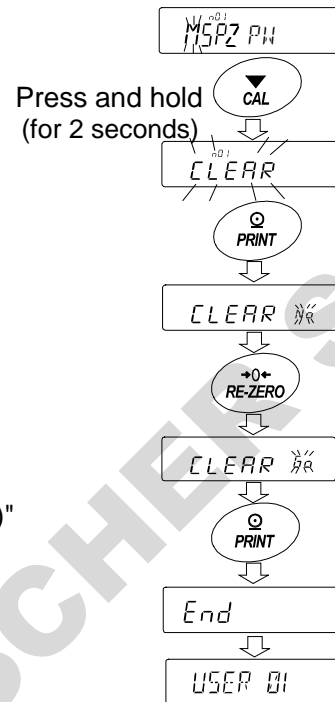

### Note

- The administrator's password can not be deleted.  
Please refer to "21-4.Regisitering Password (Changing)" and "21-5.Changing Password" to change an arbitrary password.

## 21-7 Missing Password

If the correct password is missing, the balance can not be used.  
Contact your local A&D dealer to reset the password to factory settings.

## 22.Repeatability Check Function (GX-M series only)

Repeatability is an indicator of variations in measured values when the same weight is repeatedly loaded and unloaded, and it is usually expressed in terms of standard deviation ( $\sigma_{n-1}$ ).

The GX-M series has a built-in weight.

With the repeatability check function, the balance obtains 10 measurement data using the built-in weight and displays its standard deviation.

By installing the balance and using this function, it is possible to check repeatability in the environment where the balance is installed.

Ex. "Standard deviation = 10.0mg" means that the result of repeated measurements of the same weighing material falls within the range  $\pm 10.0\text{mg}$  at a frequency of about 68%.

1. Press and hold the **[SAMPLE]** key (for 4 seconds) in the weighing display. After **[rEP tEST]** is displayed, release the key.
2. When **[rEP tEST]** is displayed, data collection starts automatically.  
While data is being collected, **[rEP]** blinks.  
To cancel, press the **[CAL]** key.  
**[CANCEL]** displays and you are returned to return to weighing mode.
3. When data collection is completed, repeatability (standard deviation) is displayed.
4. Press the **[PRINT]** key to output repeatability (standard deviation).
5. Press the **[CAL]** key to return to weighing mode.

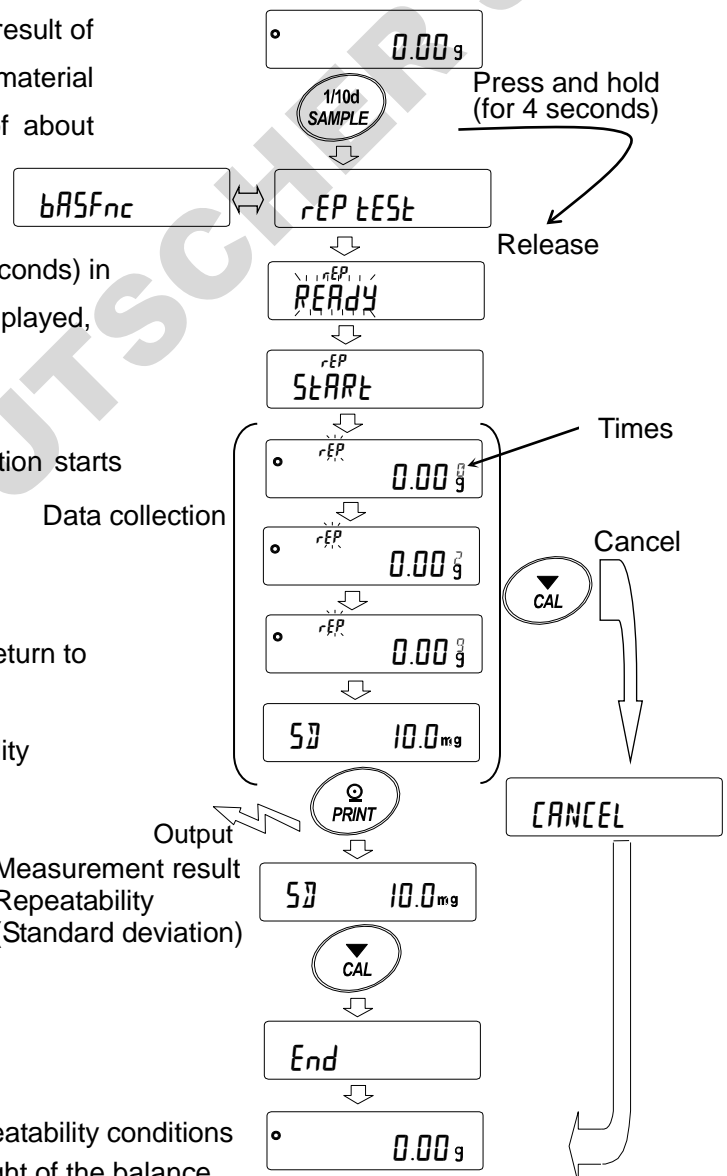

### Note

- The results of this function differs from the repeatability conditions of "28. Specifications" because it uses the weight of the balance (about 850g), so treat it as a reference value.
- In order to measure correct data, do not apply wind or vibration while collecting data.
- While using the password lock function, it can be used only when logged in as **ADMIN** (administrator).

## 23. Interface Specification (Standard)

Download "Communication manual" from our website (<https://www.aandd.jp/>) and refer to it.

## 24. Maintenance

### 24-1 Treatment Of The Balance.

In normal use, the balance can be cleaned with water. But, keep the following precautions so that dust and water do not invade the balance.

Do not direct water pressure at the bottom of the balance.

Do not use powerful water jets.

Do not submerge the balance in water.

- Clean the balance with a lint free cloth that is moistened with warm water and a mild detergent.
- Do not use organic solvents to clean the balance.
- Do not disassemble the balance. Contact the local A&D dealer if the balance needs service or repair.
- Use the original packing material for transportation.
- While cleaning the balance and keeping it waterproof, connect a waterproof RS-232C cable (AX-KO2737-500JA) or cover terminals of the RS-232C interface, USB interface and AC adapter jack. Insure that the underhook cover is in place.

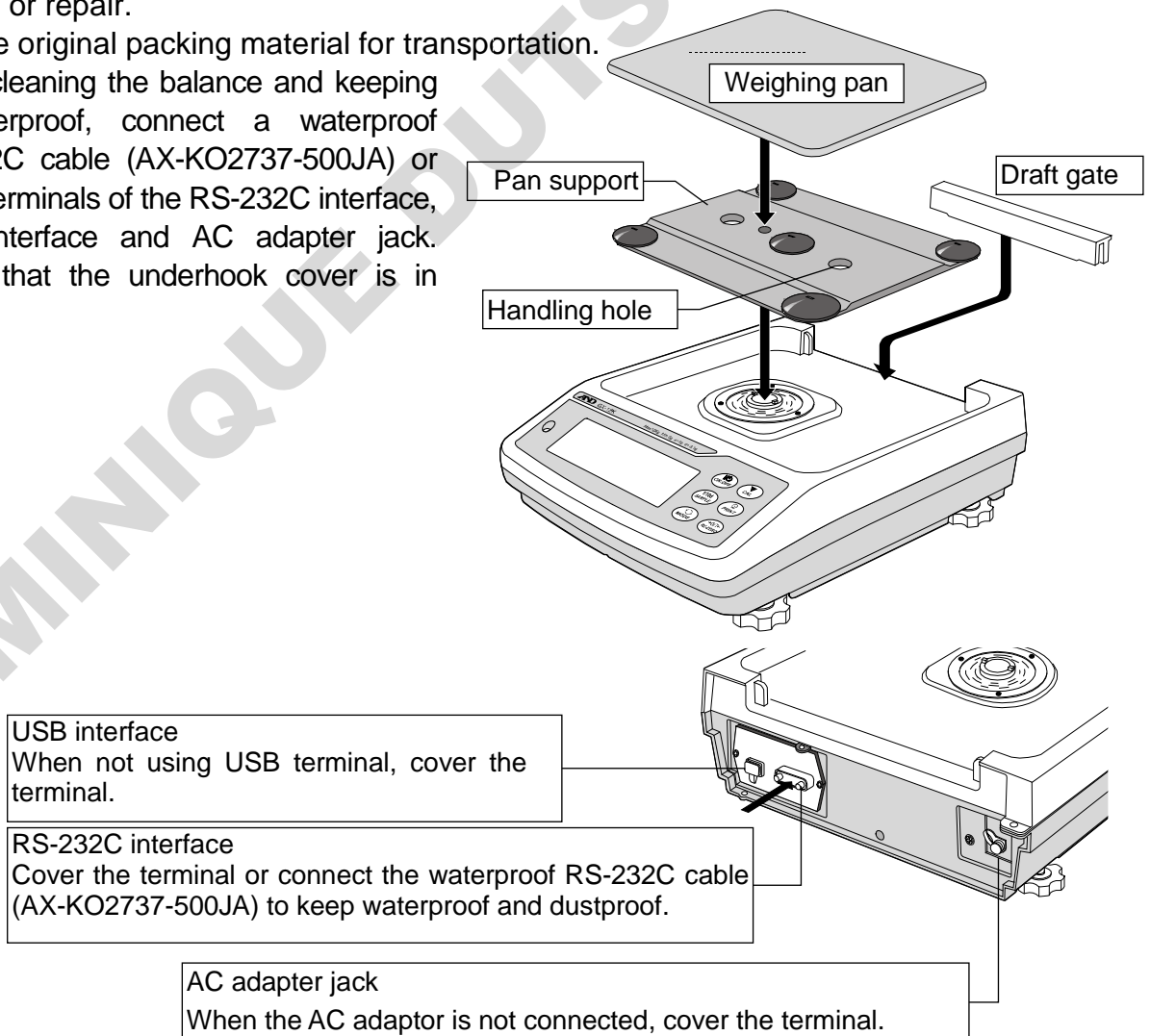

# 25. Troubleshooting

## 25-1 Checking The Balance Performance And Environment

The balance is a precision instrument. When the operating environment or the operating method is inadequate, correct weighing can not be performed. Place a sample on the pan and remove it, and repeat this several times. If the balance seems to have a problem with repeatability or to perform improperly, check as described below. If improper performance persists after checking, contact the local A&D dealer for repair.

"Frequently asked questions" and their answers are also posted on our website

<<http://www.aandd.co.jp>>.

### 1. Checking that the balance performs properly

- Please check the operation of the balance by the self diagnosis function.  
Refer to "8-2 Self-Check- Function". Fatal faults are indicated by messages.
- Check the balance performance using an external weight. Be sure to place the weight in the center of the weighing pan.
- Check the balance repeatability, linearity and calibrated value using external weights with a known value.

### 2. Checking that the operating environment or weighing method is proper

#### Operating environment

- Is the weighing table solid enough? (Especially 0.001g model)
- Is the balance level? Refer to "3. Precaution " How to adjust the bubble spirit level.
- Is the operating environment free from vibration and drafts?
- Is there a strong electrical or magnetic noise source such as a motor near the balance?







#### Weighing method

- Does the weighing pan rim touch anything? Is the weighing pan assembly installed correctly?
- Is the **RE-ZERO** key pressed before placing a sample on the weighing pan?
- Is the sample placed in the center of the weighing pan?
- Has the balance been calibrated using the internal mass (one-touch calibration)? (Only for GX-M series)
- Has the balance been warmed up for one hour before weighing?

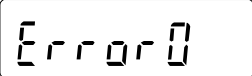
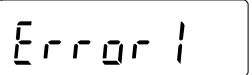
#### Sample and container

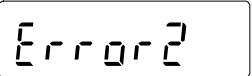
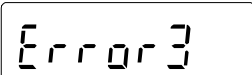
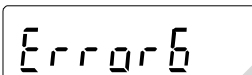
- Has the sample absorbed or lost moisture due to the ambient conditions such as temperature and humidity?
- Has the temperature of the container been allowed to equalize to the ambient temperature? Refer to "3-2 During Use".
- Is the sample charged with static electricity? Refer to "3-2 During Use".
- Is the sample of magnetic material such as iron? There are cautions about weighing magnetic materials. Refer to "3-2 During Use".

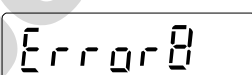
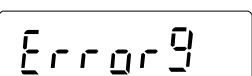
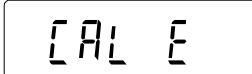
## 25-2 Error Codes

Display	Error code	Description
		<p><b>Data abnormality of the internal sensor of the balance</b></p> <ul style="list-style-type: none"> <li><input type="checkbox"/> If this error occurs during weighing and you return to the normal weighing state after a certain period of time, there is a possibility that the data temporarily became abnormal due to static electric noise if you are measuring an easily chargeable item.</li> <li>※ If the sample to be measured is charged, it is recommended that you use a AD- 1683 static eliminator to discharge the sample before measurement in order to more accurately weigh the sample.</li> <li><input type="checkbox"/> If this error continues to be displayed and can not be resolved, the internal sensor or the circuit may be damaged. Please contact your dealer.</li> </ul>
	EC, E11	<p><b>Stability error</b></p> <p>The balance cannot stabilize due to an environmental problem. Check around the pan. Prevent vibration, drafts, temperature changes, static electricity and magnetic fields, from influencing the balance. Refer to "3-2 During Use".</p> <p>To return to the weighing mode, press the  key.</p>
		<p><b>Out of the setting range</b></p> <p>The data to be stored is out of the setting range.</p>
		<p><b>Malfunction of the internal memory element of the balance</b></p> <p>If this error continues to be displayed, repair is necessary. Please contact your dealer.</p>
	EC, E16	<p><b>Internal mass error</b></p> <p>Applying the internal mass does not yield a change in the mass value as specified.</p> <p>Confirm that there is nothing on the pan and perform the weighing operation from the beginning again.</p>
	EC, E17	<p><b>Internal mass error</b></p> <p>The internal mass application mechanism does not function properly. Perform the weighing operation from the beginning again.</p>
		<p><b>Abnormality in the internal memory data of the balance</b></p> <p>If this error continues to be displayed, repair is necessary. Please contact your dealer.</p>
		<p><b>Abnormality in the internal memory data of the balance</b></p> <p>If this error continues to be displayed, repair is necessary. Please contact your dealer.</p>
	EC, E20	<p><b>Calibration weight error (Positive value)</b></p> <p>The calibration weight is too heavy. Confirm the calibration mass value. Press the  key to return to the weighing mode.</p>

Display	Error code	Description
	E C, E 2 1	<b>Calibration weight error (Negative value)</b> The calibration weight is too light. Confirm the calibration mass value. Press the <b>CAL</b> key to return to the weighing mode.
		<b>Overload error</b> A sample beyond the balance weighing capacity has been placed on the pan. Remove the sample from the pan.
		<b>Weighing pan Error</b> The mass value is too light. Confirm that the weighing pan is properly installed and calibrate the balance.
		<b>Sample mass error</b> The balance can not store the sample for the counting mode or for the percent mode because it is too light. Use a larger sample.
  		<b>Unit mass error</b> The sample unit mass for the counting mode is too light. Storing and using it for counting will cause a counting error. Add samples to reach the specified number and press the <b>PRINT</b> key. Pressing the <b>PRINT</b> key without adding samples will shift the balance to the counting mode. But, for accurate counting, be sure to add samples.
		<b>Clock battery error</b> The clock backup battery has been depleted. Press any key and set the time and date. The clock and calendar function works normally as long as the AC adapter is connected to the balance. If this error appears frequently, contact the local A&D dealer.
		<b>Power supply voltage fault</b> The voltage supplied from the AC adapter is abnormal. Please check if the problem is the AC adapter (TB248) supplied with the balance.
 		<b>ECL repeatability</b> With the self-check function, the standard deviation (SD) of repeatability due to electronically controlled load (ECL) exceeded 50 digits. Please revise the installation environment of the balance. <input type="checkbox"/> <b>SD Error</b> This is displayed when repeatability is displayed by ECL. <input type="checkbox"/> <b>MW Error</b> This is displayed when the minimum weighing value (reference value) by ECL is displayed. Refer to "8-2.Self-Check-Function / Automatic Setting Of Minimum Weight Value."
		<b>Full memory</b> The maximum number or stored weighing values has been reached. In order to store more weighing values, it is necessary to delete the data. Refer to "13.Data Memory"

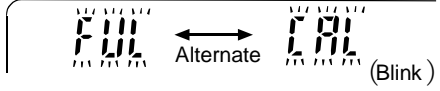
Display	Error code	Description
		<b>Full memory</b> The stored calibration history has reached 50 instances. If more is stored, the old history will be deleted. Refer to "13.Data Memory"
	E C, E 0 0	<b>Communications error</b> A protocol error occurred in communications. Confirm the format, baud rate and parity.
	E C, E 0 1	<b>Undefined command error</b> An undefined command was received. Confirm the command.
	E C, E 0 2	<b>Not ready</b> A received command can not be processed. Example: <ul style="list-style-type: none"> <li>□ The balance received a "Q" command, but not in the weighing mode.</li> <li>□ The balance received a "Q" command while processing a RE-ZERO command. Adjust the delay time to transmit a command.</li> </ul>
	E C, E 0 3	<b>Timeout error</b> If the timeout parameter is set to "t-UP !", the balance did not receive the next character of a command within the time limit of one second. Confirm the communication.
	E C, E 0 4	<b>Excess characters error</b> The balance received excessive characters in a command. Confirm the command.
	E C, E 0 6	<b>Format error</b> A command includes incorrect data. Example: <ul style="list-style-type: none"> <li>□ The data is numerically incorrect.</li> </ul> Confirm the command.
	E C, E 0 7	<b>Parameter setting error</b> The received data exceeds the range that the balance can accept. Confirm the parameter range of the command.



## 25-3 Other Display



When this indicator ( ◀ ) blinks, automatic self calibration is required. The indicator blinks when the balance detects changes in ambient temperature. If the balance is not used for several minutes with this indicator blinking, the balance performs automatic self calibration. The blinking period depends on the operating environment.

**Advise** The balance can be used while this indicator is blinking. We recommend that you perform automatic self calibration for precision weighing.

## 25-4 Asking For Repair

If the balance needs service or repair, contact your local A&D dealer.

The balance is a precision instrument. Use much care when handling the balance and observe the following when transporting the balance.

- Use the original packing material for transportation.
- Remove the weighing pan, pan support, breeze break ring and dust plate from the main unit.

## 26.Connection With Periphecal Device

Download "Communication manual" from our website (<https://www.aandd.jp/>) and refer to it.

### 26-1 Command

Download "Communication manual" from our website (<https://www.aandd.jp/>) and refer to it.

### 26-2 Key Lock Function

This function restricts the key operation of the balance by sending a specified command to the balance.

Download "Communication manual" from our website (<https://www.aandd.jp/>) and refer to it.

## 27.How To Check The Software Version Of The Balance

Specifications may vary depending on the software version of the balance.

1. Insert the AC adapter on the balance again.

2. P-\*.\*\*\* will be displayed.

The number of " \*.\*\*\* " becomes the software version.

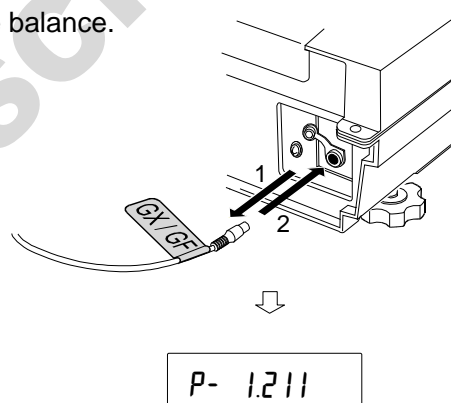

## 28. Specifications

	GX-8202M	GX-8202MD	GX-10202M	GX-12001M	GX-22001M	GX-32001M	GX-32001MD
Weighing capacity	8.2 kg		10.2 kg	12.2kg	22.2 kg	32.2 kg	
Maximum display	8.20084kg	8.2008kg	10.20084kg	12.2084kg	22.2084kg	32.2084kg	32.008kg
		2.20009kg*1					6.2009kg*1
Minimum weighing value (1 digit)	0.01 g	0.1 g / 0.01 g	0.01 g	0.1 g			1g / 0.1 g
Repeatability (Standard deviation)	0.01 g	0.05 g / 0.01g	0.01 g	0.1 g			0.5g / 0.1 g
Linearity	±0.03 g	±0.1 g / ±0.02 g	±0.03 g	±0.2 g			±1g / ±0.2 g
Stabilization time (Typical at <u>FAST</u> )	Approx. 1.5 seconds						
Sensitivity drift, (10°C ~ 30°C / 50°F ~ 86°F)	±2 ppm/°C	±3 ppm/°C	±2 ppm/°C	±3 ppm/°C			±5 ppm/°C
Accuracy right after calibration using the internal mass (Accuracy of full scale) *2	±0.15 g	±0.3 g	±0.15 g	±1.0 g		±1.5 g	±3 g
Operating environment	5°C to 40°C (41°F to 104°F), 85%RH or less (No condensation)						
Internal mass	Built-in function						
Weighing data of data memory	200 data						
Time and clock function	Built-in function						
Display refresh rate	5 times/second, 10 times/second or 20 times/second						
Counting mode	Minimum unit mass	0.01 g	0.1 g	0.01 g	0.1 g		1g
	Number of samples	10, 25, 50 or 100 pieces					
Percent mode	Minimum 100% reference mass	1 g	10 g	1 g	10 g		100g
	Minimum 100% display	0.01 %, 0.1 %, 1 % (Depends on the reference mass stored.)					
Interface (Provided as standard)	USB, RS-232C						
External calibration weight	2 kg, 3 kg, 4 kg, 5 kg, 6 kg, 7 kg, 8 kg		2 kg, 3 kg, 4 kg, 5 kg, 6 kg, 7 kg, 8 kg, 9 kg, 10 kg	5 kg, 10 kg	5 kg, 10 kg, 20 kg	10 kg, 20 kg, 30 kg	
Weighing pan	270 x 210 mm						
External dimensions	300(W) x 355(D) x 111(H) mm						
Power supply & AC adapter type	Power consumption: Approx. 30VA (supplied to the AC adapter ) Confirm that the adapter type is correct for the local voltage and power receptacle type.						
Weight	Approx. 9.3kg						
Dust and water protection	Complying with IP65						

\*1: The balance allows weighing using a precision range, even with a heavy tare placed on the pan. (Smart range function)

\*2: With GX-M series, accuracy right after calibration using the internal mass in good ambient conditions (within the temperature range of 10°C to 30°C (50°F to 86°F) with no abrupt changes in temperature or humidity, no drafts, no effect by magnetic fields or static electricity).

□Check the internal mass periodically as described in "24. Maintenance".

	GF-8202M	GF-8202MD	GF-10202M	GF-12001M	GF-22001M	GF-32001M	GF-32001MD
Weighing capacity	8.2 kg		10.2 kg	12.2 kg	22.2 kg	32.2kg	
Maximum display	8.20084kg	8.2008kg	10.20084kg	12.2084kg	22.2084kg	32.2084kg	32.008kg
		2.20009kg*1					6.2009kg*1
Minimum weighing value (1 digit)	0.01 g	0.1 g / 0.01 g	0.01 g	0.1 g		1 g / 0.1 g	
Repeatability (Standard deviation)	0.01 g	0.05 g / 0.01 g	0.01 g	0.1 g		0.5 g / 0.1 g	
Linearity	±0.03 g	±0.1 g / ±0.02g	±0.03 g	±0.2 g		±1 g / ±0.2 g	
Stabilization time (Typical at <b>FAST</b> )	Approx. 1.5 seconds						
Sensitivity drift, (10°C ~ 30°C / 50°F ~ 86°F)	±2 ppm/°C	±3 ppm/°C	±2 ppm/°C	±3 ppm/°C		±5 ppm/°C	
Operating environment	5°C to 40°C (41°F to 104°F), 85%RH or less (No condensation)						
Internal mass	not available						
Weighing data of data memory	200 data						
Time and clock function	Built-in function						
Display refresh rate	5 times/second, 10 times/second or 20 times/second						
Counting mode	Minimum unit mass	0.01 g	0.1 g	0.01 g	0.1 g		1g
	Number of samples	10, 25, 50 or 100 pieces					
Percent mode	Minimum 100% reference mass	1 g	10 g	1 g	10 g		100g
	Minimum 100% display	0.01 %, 0.1 %, 1 % (Depends on the reference mass stored.)					
Interface (Provided as standard)	USB, RS-232C						
External calibration weight	2 kg, 3 kg, 4 kg, 5 kg, 6 kg, 7 kg, 8 kg		2 kg, 3 kg, 4 kg, 5 kg, 6 kg, 7 kg, 8 kg, 9 kg, 10 kg	5 kg, 10 kg	5 kg, 10 kg, 20 kg	10 kg, 20 kg, 30 kg	
Weighing pan	270 x 210mm						
External dimensions	300(W) x 355(D) x 111(H) mm						
Power supply & AC adapter type	Power consumption: Approx. 30VA (supplied to the AC adapter ) Confirm that the adapter type is correct for the local voltage and power receptacle type.						
Weight	Approx. 8.3kg						
Dust and water protection	Complying with IP65						

\*1: The balance allows weighing using a precision range, even with a heavy tare placed on the pan. (Smart range function)

## 29. External Dimension

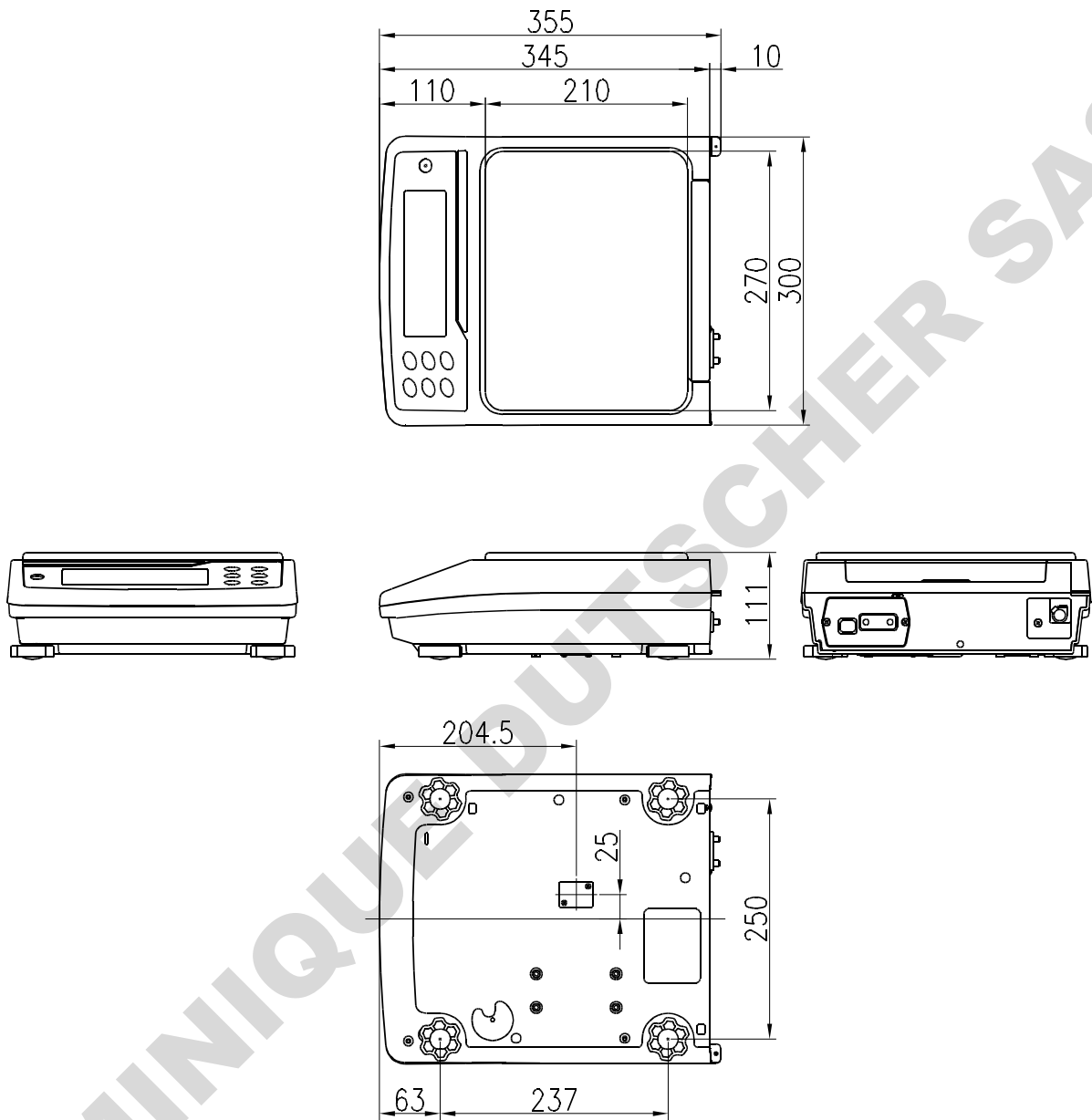

Unit: mm

## 29-1 Options And Peripheral Instruments

### Options

Name	Description
GXM-04 <b>Comparator Output (Relay/ with a Buzzer) / RS-232C / External key input</b>	<ul style="list-style-type: none"> <li>□ This option is equipped with relay and buzzer output, RS-232C interface and external <b>key</b> input terminal that can operate "PRINT" and "RE-ZERO" externally. This option generates a relay output corresponding to <b>HI</b> , <b>OK</b> and <b>LO</b> in the display..</li> <li>□ This option is not available for use of USB interface simultaneously because it will be installed in slot for the standard USB/RS-232C interface.</li> </ul>
GXM-06 <b>Analog Voltage Output / RS-232C</b>	<ul style="list-style-type: none"> <li>□ This option outputs a voltage of 0 to1V (or 0.2 to1V) depending on the displayed value.</li> <li>□ This option is not available for use of USB interface simultaneously because it will be installed in slot for the standard USB/RS-232C interface.</li> </ul>
AX-KO2737-500JA <b>Waterproof and Dustproof RS-232C Cable</b>	<ul style="list-style-type: none"> <li>□ Length 5m, straight type, D-sub 9pin - D-sub 9pin.</li> <li>□ 9pin of balance side is only waterproof type.</li> </ul>
GXK-012 <b>Animal Weighing Bowl</b>	<ul style="list-style-type: none"> <li>□ This bowl can be used to weigh a small animal.</li> <li>□ When using this bowl, the weighing range that can be used is an approximately 1.5 kg less than the weighing capacity.</li> </ul>

**Note** When option GXM-04 or GXM-06 is installed in the balance, the balance does not comply with IP-65 (waterproof and dustproof).

## Printer

Name	Description
AD-8127 <b>Multi Printer</b>	<ul style="list-style-type: none"> <li>□ Multi functions</li> <li>□ Statistical function, clock and calendar function, interval print function, graphic print function, dump print mode</li> <li>□ 5 x 7 dots, 24 characters per line</li> <li>□ Print paper (AX-PP137, 57.5 (W) x 30 (L) mm) Clean paper (AX-PP173, 57.5 (W) x 30 (L) mm)</li> <li>□ AC adapter</li> </ul>

## Extension of communication

Name	Description
AD-1688 <b>Data Logger</b>	<ul style="list-style-type: none"> <li>□ When connected to the RS-232C interface of the balance, the AD-1688 can store the data in an environment where a personal computer can not be used. The stored data can be read to a personal computer using USB. As the AD-1688 is recognized as USB memory, special software is not required to read the data.</li> </ul>
AD-1687 <b>Weighing Environment Logger</b>	<ul style="list-style-type: none"> <li>□ A data logger equipped with 4 sensors for temperature, humidity, barometric pressure and vibration that can measure and store environmental data. When connected to the RS-232C interface of the balance, the AD-1687 can store environmental data along with weighing data. Therefore, it is possible to store data in an environment where a computer can not be used. The stored data can be read to a personal computer using USB. As the AD-1687 is recognized as USB memory, special software is not required to read the data.</li> </ul>
AD-8527 <b>Quick USB Adapter</b>	<ul style="list-style-type: none"> <li>□ Can transmit weighing data to a personal computer in real time when connected to the RS-232C interface of the analyzer and to the computer using USB.</li> <li>□ Data transmission to any application such as Excel and Word. (Simplex)</li> </ul>
AX-USB-9P-EX <b>USB Converter</b>	<ul style="list-style-type: none"> <li>□ Adds a COM port to a PC.</li> <li>□ Enables bi-directional communication between the PC and the balance when a USB driver is installed.</li> <li>□ Can use serial communication software such as WinCT on a PC without COM ports.</li> <li>□ An RS-232C cable is provided to connect the USB converter to the balance.</li> </ul>
AD-8526 <b>Ethernet Converter</b>	<ul style="list-style-type: none"> <li>□ Connects the RS-232C interface of the analyzer to the Ethernet (LAN) port of a computer that is not equipped with an RS-232C interface. (Duplex)</li> <li>□ Can manage weighing data using a network.</li> <li>□ Includes the communication software "WinCT-Plus".</li> </ul>

## Countermeasures against static electricity

Name	Description
AD-1683 <b>DC Static Eliminator</b>	<ul style="list-style-type: none"> <li>□ Used to minimize weighing errors due to static electricity on the material. The AD-1683 is direct-current static eliminator. The ions generated produce no breeze and are effective over a long distance. Therefore, the balance can accurately weight powders, etc. by using the AD-1683.</li> </ul>
AD-1684 <b>Electrostatic Field Meter</b>	<ul style="list-style-type: none"> <li>□ This option measures the amount of the static charge on the sample, tare or peripheral equipment and displays the result. If those are found to be charged, discharge them using the AD-1683 DC static eliminator.</li> </ul>

## External indicators

Name	Description
AD-8920A <b>Remote Display</b>	<ul style="list-style-type: none"> <li>□ This option can be connected to the balance using the RS-232C interface or current loop and displays the weighing data transmitted by the balance.</li> </ul>
AD-8922A <b>Remote Controller</b>	<ul style="list-style-type: none"> <li>□ This option can be connected to the balance using the RS-232C interface and can control the balance remotely.</li> <li>□ Various options such as comparator output or analog output are available.</li> </ul>

## Others

Name	Description
AD-1691 <b>Weighing Environment Analyzer</b>	<ul style="list-style-type: none"> <li>□ The analyzer can be used for diary check and analysis and proof of the cause of a weighing error.</li> <li>□ The analyzer can be used to deal with weighing errors. Quality control can be managed easily by using as a standalone analyzer (without using a computer).</li> </ul>
AD-1682 <b>Rechargeable Battery</b>	<ul style="list-style-type: none"> <li>□ This option allows use of the balance where AC power is unavailable. Duration of continuous operation is approx. 6 hours when connected to the GX-M / GF-M series. Discharged battery can be used repeatedly by recharging.</li> </ul>





MEMO

DOMINIQUE DUTSCHER SAS

**DOMINIQUE DUTSCHER SAS**



#### **A&D Company, Limited**

3-23-14 Higashi-Ikebukuro, Toshima-ku, Tokyo 170-0013, JAPAN  
Telephone: [81] (3) 5391-6132 Fax: [81] (3) 5391-1566

#### **A&D ENGINEERING, INC.**

1756 Automation Parkway, San Jose, California 95131, U.S.A.  
Telephone: [1] (408) 263-5333 Fax: [1] (408) 263-0119

#### **A&D INSTRUMENTS LIMITED**

Unit 24/26 Blacklands Way, Abingdon Business Park, Abingdon, Oxfordshire OX14 1DY United Kingdom  
Telephone: [44] (1235) 550420 Fax: [44] (1235) 550485

#### **A&D AUSTRALASIA PTY LTD**

32 Dew Street, Thebarton, South Australia 5031, AUSTRALIA  
Telephone: [61] (8) 8301-8100 Fax: [61] (8) 8352-7409

#### **A&D KOREA Limited**

한국에이.엔.디(주)  
서울특별시 영등포구 국제금융로6길33 (여의도동) 맨하탄빌딩 817 우편 번호 07331  
( 817, Manhattan Bldg., 33. Gukjegeumyung-ro 6-gil, Yeongdeungpo-gu, Seoul, 07331 Korea )  
전화: [82] (2) 780-4101 팩스: [82] (2) 782-4264

#### **ООО A&D RUS**

ООО "ЭЙ энд ДИ РУС"  
121357, Российская Федерация, г.Москва, ул. Верейская, дом 17  
( Business-Center "Vereyskaya Plaza-2" 121357, Russian Federation, Moscow, Vereyskaya Street 17 )  
тел.: [7] (495) 937-33-44 факс: [7] (495) 937-55-66

#### **A&D INSTRUMENTS INDIA PRIVATE LIMITED**

509, उद्योग विहार, फेस -5, गुडगांव - 122016, हरियाणा, भारत  
( 509, Udyog Vihar, Phase-V, Gurgaon - 122 016, Haryana, India )  
फोन : 91-124-4715555 फैक्स : 91-124-4715599

#### **ऐ&डी इन्स्ट्रुमेन्ट्स इण्डिया प्रा० लिमिटेड**