

making a difference

APPLICATION

NOTE

UV/VIS Spectroscopy in Microplates
UV-Star[®], μ Clear[®], MICROLON
and CELLSTAR[®]

www.gbo.com/bioscience

greiner
BIO-ONE

1/ INTRODUCTION TO UV/ VIS SPECTROSCOPY

Transparent microplates (CELLSTAR®, MICROLON) or microplates with a clear film bottom (µClear®, UV-Star®) are frequently used in ultraviolet-visible spectroscopy (UV/VIS). UV/VIS is a subclass of spectroscopy which uses visible light and adjacent near ultraviolet (UV) ranges for the determination of the concentrations and the characterization of dissolved substances.

Most dissolved molecules absorb light in the visible or UV range at specific wavelengths. The absorption of light (**Fig. 1**) is a physical process where the amount of absorbed light depends on the concentration of the substance c , the thickness of the liquid layer d and a specific absorption coefficient α at a defined wavelength λ . Different terms define the process of light absorbance. For a better overview the most frequently used terms are listed and defined in section 1.1.

1.1/ DEFINITION OF DIFFERENT TERMS IN UV/VIS SPECTROSCOPY

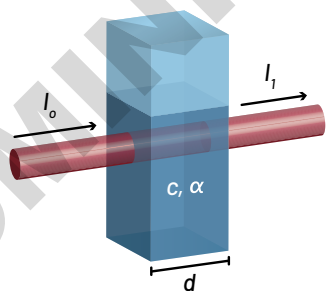

Figure 1: Principle of UV/VIS spectroscopy

- I_0 : Intensity of the light beam before passing the sample
- I_1 : Intensity of the transmitted light (Light beam that has passed through the sample)
- c : Concentration of the dissolved molecule
- α : Molar extinction coefficient
- d : Length of the sample (pathlength)

Transmission and transmittance are often used as synonyms. In spectroscopy the physical phenomenon of light transmission through a sample can be described by the fraction of light at a specific wavelength λ that passes through the sample. If I_0 is the intensity of the incident light and I_1 the intensity of the transmitted light, then the **transmittance T** can be defined as:

$$T = \frac{I_1}{I_0} \quad [1]$$

In parallel, the transmittance can be described by the **light absorbance A_λ** or **optical density OD_λ** :

$$A_\lambda = OD_\lambda = -\log_{10} = \frac{I_1}{I_0} \quad [2]$$

The higher the optical density of the sample, the higher the absorption and the lower is the transmission of light. Often the transmission is given as a percentage (**Fig. 2a**). Although the absorbance or optical density does not have true units, it is customarily reported in **absorbance units (AU)** (**Fig. 2b**).

The absorbance or optical density depends on the wavelength λ and the pathlength d (**Fig. 1**). In order to be able to compare measurements the optical density is often calibrated to a defined pathlength, typically 1 cm.

Optical densities above 1.0 should be avoided in a sensitive measurement as even large differences in the optical density readouts represent only minor modifications in the transmission (**Table 1**).

It is recommended to dilute samples with a high optical density in order to achieve results below 1.0.

Optical density	Transmission
1.5	3 %
1.7	2 %
2.0	1 %

Table 1: Optical density above 1.0 and their relation to the transmission

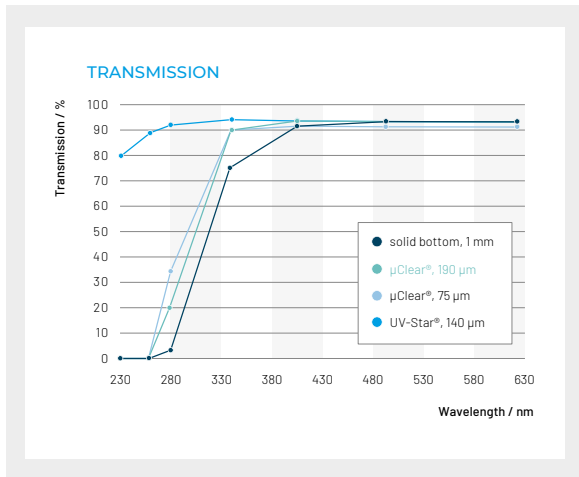

Figure 2a: Transmission in solid bottom polystyrene (1 mm bottom thickness), µClear® (190 µm and 75 µm polystyrene film bottom) and UV-Star® (135 µm film bottom) microplates.

1.2/ OPTICAL BACKGROUND OF GREINER BIO-ONE SOLID BOTTOM POLYSTYRENE, µCLEAR® AND UV-STAR® MICROPLATES IN TRANSMISSION MEASUREMENTS

As evidenced in figures 2a and 2b, the high transmission of standard polystyrene microplates drops off sharply at approximately 400 nm, whereas µClear® plates extend detection capabilities down to 340 nm. UV-Star® Microplates demonstrate the highest transmission within the lower UV range down to 230 nm.

Conversely, optical density increases proportionally in accordance with transmittance wavelength values indicated for the corresponding microplate type.

1.3/ LAMBERT-BEER'S LAW

The absorption of light in a sample solution is dependent on the concentration c of the dissolved molecule, the specific molar extinction coefficient α at a defined wavelength λ and the pathlength d .

With known extinction coefficient and pathlength, the concentration of a sample can be determined by using the **Lambert-Beer's equation (3)**.

As well, Lambert-Beer's law can be used to determine the **molar extinction coefficient (4)**.

An example for the determination of the molar extinction coefficient of adenosine 5'-tri-phosphate (ATP) is given in **example 1**.

LAMBERT-BEER'S LAW:

$$A_{\lambda} = -\log_{10} \frac{I_1}{I_0} = \alpha_{\lambda} \cdot c \cdot d \quad [3]$$

- c : Concentration of the dissolved absorbing molecule. Typically defined as $[\text{mol} \cdot \text{dm}^{-3}]$ or $[\text{mol} \cdot \text{l}^{-1}]$
- α_{λ} : Molar extinction coefficient which is for the absorbing molecule a specific dimension at a defined wavelength λ . It can be dependent on the solvent and e.g. pH of the solution. The dimension of the extinction coefficient is $[\text{dm}^3/\text{mol} \cdot \text{cm}]$ or $[\text{l}/\text{mol} \cdot \text{cm}]$
- d : Distance light has to pass through the material [cm]

Determination of the molar extinction coefficient:

$$\alpha_{\lambda} = \frac{A_{\lambda}}{c \cdot d} \quad [4]$$

EXAMPLE 1: DETERMINATION OF THE MOLAR EXTINCTION COEFFICIENT OF ATP

ATP was solved in water at pH 7 and measured at 260 nm [1]. The OD_{260} of different ATP concentrations was determined and calibration curves for **UV-Star® Microplates and cuvettes** were generated (Fig. 3).

The absorbance (A_{260}) of a 30 $\mu\text{M/l}$ ATP solution (c) was 0.407. The pathlength d of the sample was 1 cm. Based on the data the molar extinction coefficient was calculated using **equation (4)**.

$$\alpha_{\lambda} = \frac{A_{\lambda}}{c \cdot d} \quad [4]$$

Absorption $A_{\lambda} = 0.407 \text{ AU}$
Concentration $c = 30 \mu\text{M/l}$
Pathlength $d = 1 \text{ cm}$

$$\alpha_{\lambda} = \frac{0.4071}{30 \mu\text{M} \cdot \text{cm}}$$

$$\alpha_{\lambda} = 13.57 \cdot 10^{-3} \frac{1}{\mu\text{M} \cdot \text{cm}}$$

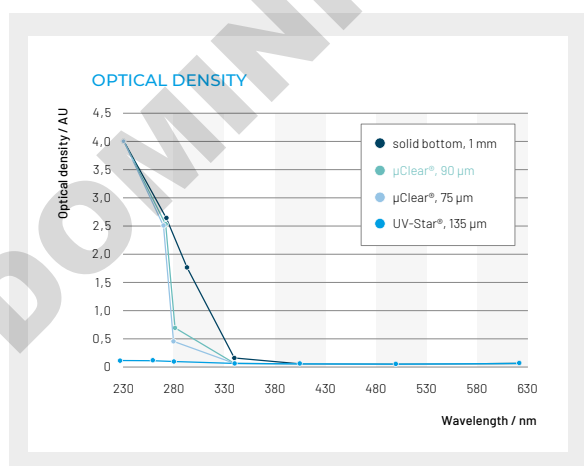

Figure 2b: Optical density in solid bottom polystyrene (1 mm bottom thickness), μClear° (190 μm and 75 μm polystyrene film bottom) and **UV-Star $^{\circ}$** (135 μm film bottom) microplates

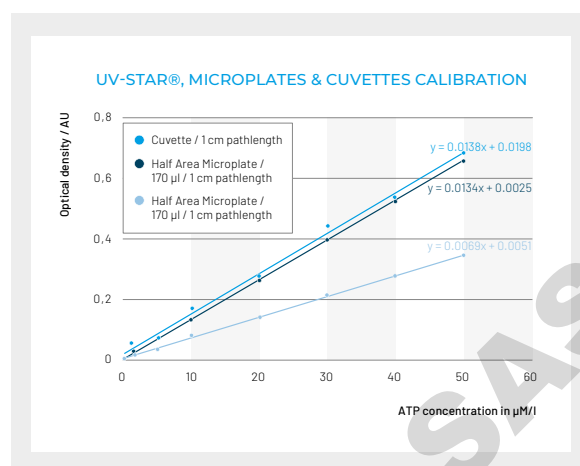

Figure 3: ATP was dissolved in water at pH 7 and measured at room temperature at 260 nm

2/ UV/VIS OF NUCLEIC ACIDS AND PROTEINS

The optical density of biomolecules such as DNA, RNA and proteins is influenced by pH, temperature and salt concentration [2]. The absorbance of a solution decreases with increasing ionic strength, e.g. DNA has approximately 23 % lower absorbance when dissolved in buffered saline rather than water [3]. Similarly, exact molar extinction coefficients are dependent upon the nucleotide sequence for nucleic acids or the amino acid type and amino acid sequence in peptides or proteins. Therefore molar extinction coefficients α_{λ} are not commonly applied in molecular biology to determine biomolecular concentrations.

Instead scientists prefer to use empirically determined standard coefficients s_c (**Table 2; Equation 5**). Because these standard coefficients are derived from optical density measurements at 1 cm, they are only valid if the pathlength used for the sample measurement is also 1 cm. For instance, if the optical density of a double stranded DNA sample with 50 μg DNA/ml water is equal to one absorbance unit at 1 cm pathlength, then the standard coefficient of double stranded DNA is 50 $\mu\text{g/ml}$, also at 1 cm pathlength.

$$\text{Concentration of sample} = \text{OD} \cdot \text{sc} \cdot \text{f} \quad [5]$$

OD: Optical density
 sc: Standard coefficient
 f: Dilution factor of the sample

Example 2 shows the calculation of the concentration of an aqueous double stranded DNA sample applying the standard coefficient and the appropriate **equation (5)**.

EXAMPLE 2:

An aqueous sample of genomic DNA gave an optical density of 0.8 AU. The sample was diluted 1:25 to achieve an OD below 1.0. The measurement was done in a cuvette with a pathlength of 1 cm. With the standard coefficient of double stranded DNA (50 µg/ml) the concentration can be calculated using **equation (5)**.

$$\begin{aligned} \text{Concentration of sample} &= \text{OD} \cdot \text{sc} \cdot \text{f} \quad [5] \\ &= 0.8 \cdot 50 \mu\text{g/ml} \cdot 25 \\ &= 1000 \mu\text{g/ml} \end{aligned}$$

Biomolecule	λ	Pathlength	Standard coefficient
Double stranded DNA	260 nm	1 cm	50 µg/ml
Single stranded DNA	260 nm	1 cm	33 µg/ml
Single stranded RNA	260 nm	1 cm	40 µg/ml
Oligo-nucleotides	260 nm	1 cm	20 µg/ml

Table 2: Commonly used standard coefficients for biomolecules

The use of standard coefficients leads to approximations rather than precise determinations of biomolecule concentration within a sample (**Table 4, Table 6**). However standard coefficients have proven to be easy to use with sufficient accuracy for daily laboratory work. To avoid large divergences assay conditions should be considered when determining concentration of nucleic acids or proteins on the basis of standard coefficients.

2.1/ MICROPLATES FOR THE UV/VIS DETERMINATION OF NUCLEIC ACIDS AT 260 NM AND PROTEINS AT 280 NM

Standard microplates are only partially suitable for transmission measurements in the UV range (**Fig. 2a and 2b**). Polystyrene absorbs UV light especially in the short-wavelength range below 400 nm. µClear® Microplates with a thin polystyrene based film display much lower background values and can be used down to 340 nm. The adaptation of the patented µClear® process technology to an innovative UV-transparent material enabled the production of microplates that extend the transmission range down to 230 nm.

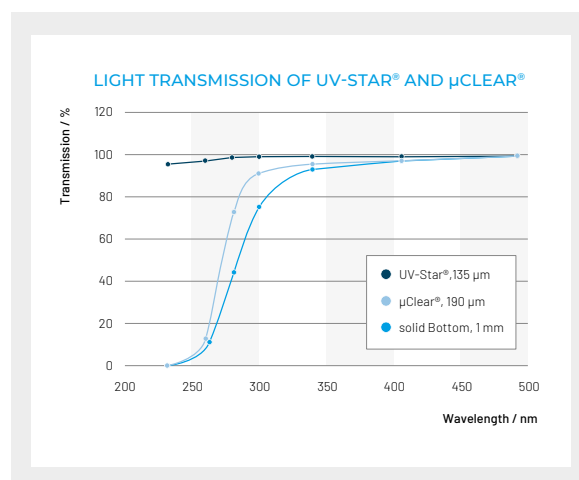

Figure 4: Light transmission of UV-Star® and µClear® Microplates compared with a conventional microplate

For the determination of nucleic acid and protein concentrations at 260 nm without background interference, UV-Star® Microplates are the ideal alternative to expensive and fragile quartz glass plates or cuvettes (Fig. 4). UV-Star® Microplates are DMSO resistant, can be stored at -20 °C without issue, and are available in 96 well, 96 well half area, and 384 well formats (Table 3).

Item No.	Description	Packaging
655801	96 well standard UV-Star® Microplate	10 / bag; 40 / case
675801	96 well Half Area UV-Star® Microplate	10 / bag; 40 / case
781801	384 well standard UV-Star® Microplate	10 / bag; 40 / case

Table 3: UV-Star® Microplates product range

3/ UV/VIS SPECTROSCOPY IN MICROPLATES

The pathlength of a sample in a transmission measurement in a standard cuvette is normally 1 cm, as almost all cuvettes have a standardised pathlength of 1 cm. This is not the case for measuring optical density within microplates. Here the pathlength is determined by the amount and corresponding height of liquid sample filled in each well (Fig. 5 and 6). For a direct comparison of an OD measurement made in a microplate well with an OD measurement made in a cuvette, the results of the microplate well must be recalculated to a pathlength of 1 cm. The recalculation can then be carried out using equation 6:

$$OD_{\lambda 1cm} = \frac{OD_{\lambda \text{ sample}}}{d [\text{cm}]} \quad [6]$$

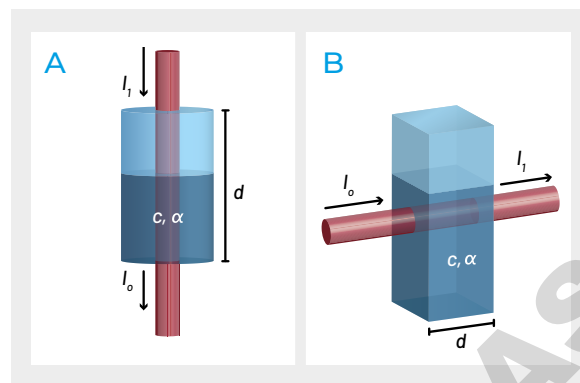

Figure 5: Variable pathlength in a microplate well (A) compared to a fix pathlength in a cuvette (B)

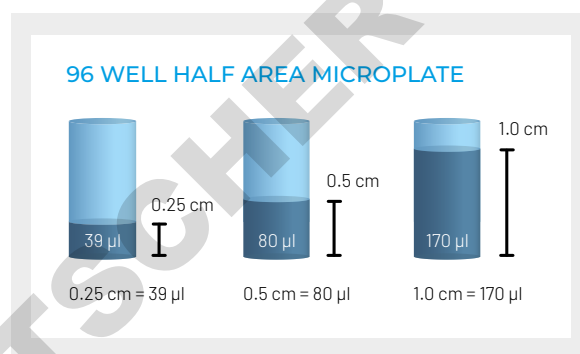

Figure 6: Resultant pathlengths with different sample volumes within the well of a 96 well half area microplate

3.1/ ADAPTATION TO 1 CM PATHLENGTH

Several options are available to achieve the pathlength correction to 1 cm.

3.1.1/ MATHEMATICAL APPROACH

The simplest method to recalculate the absorbance in a microplate well to a pathlength of 1 cm is by using a mathematical approach.

Depending on the geometry of the specific microplate well (i.e. customarily cylindrical shaped in the case of round well tops; rectangular in the case of square well tops), the adequate formula must be used (Fig. 7a). The dimensions of the wells of most Greiner Bio-One microplates are listed in our catalogue or can be downloaded from our website (www.gbo.com/bioscience).

The calculation of the liquid height using the mathematical approach is shown in **example 3** and **example 4**. Due to a slight tapering in the well geometry, the mean diameter of a filled well can only be estimated, and the meniscus of the liquid in the well cannot be taken into account either. However the mathematical approach is simple, without need for any special devices, with final results comparable to measurements performed with a cuvette (**Table 4**).

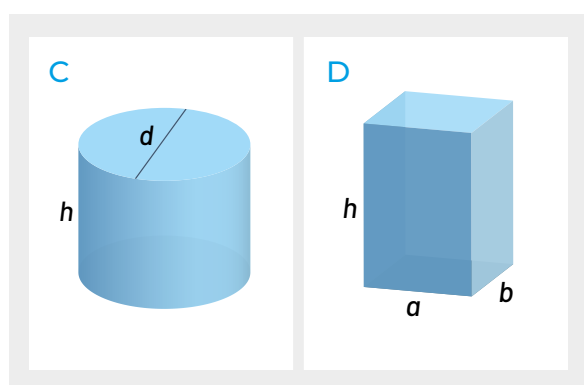

Figure 7a: Volume of diverse bodies

CYLINDRICAL WELLS (C):

$$h = \frac{4 \cdot V}{\pi \cdot d^2} \quad [7]$$

This formula can be used for calculating the filling level in relation to the filling volume in a 96 well microplate with cylindrical wells.

RECTANGULAR WELLS (D):

$$h = \frac{V}{a \cdot b} \quad [8]$$

This formula can be used for calculating the filling level in relation to the filling volume in 384 and 1536 well microplates with rectangular wells.

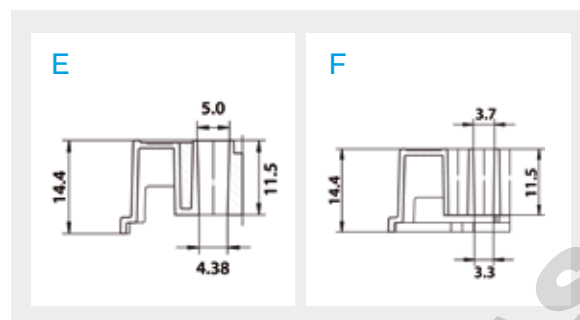

Figure 7b: Well geometry of a 96 well half area microplate (E) and a well geometry of a 384 well standard microplate (F)

EXAMPLE 3:

The volume of 100 μl is equivalent to a liquid height of 5.8 mm in a well of a half area microplate.

$$h = \frac{4 \cdot V}{\pi \cdot d^2} \quad [7]$$

$$h = \frac{4 \cdot 100 \text{ mm}^3}{3.14 \cdot (4.69 \text{ mm})^2} = 5.8 \text{ mm}$$

EXAMPLE 4:

The volume of 100 μl is equivalent to a liquid height of 8.2 mm in a standard 384 well microplate.

$$h = \frac{V}{a \cdot b} \quad [8]$$

$$h = \frac{100 \text{ mm}^3}{(3.5 \text{ mm})^2} = 8.2 \text{ mm}$$

CALCULATION OF THE CONCENTRATION OF AN AQUEOUS DNA SAMPLE

Measurements taken in a half area microplate well (Item No. 675801) with a sample volume of 100 μl were compared with those from a quartz glass cuvette (1 cm pathlength, 1000 μl

sample volume). The pathlength of the half area microplate well was calculated using **equation (7)** with the dimensions given in **figure 7b**. The final DNA concentration was calculated using the standard coefficient of DNA (50 µg/ml). The results are listed in **table 4**.

	Half Area Microplate
OD	0.43
Pathlength 100 µL	0.6 cm
OD corrected to 1 cm (OD _{1cm})	0.72
Calculated DNA concentration	36 µg/ml

	Quartz Glass Cuvette
OD 1 cm	0.68
Calculated DNA concentration	34 µg/ml

Table 4: Final calculated DNA concentration

3.1.2/ ABSORPTION OF WATER IN THE NEAR INFRARED (NIR) AS REFERENCE FOR A PATHLENGTH CORRECTION

Water is essentially transparent from 200 to 900 nm (**Fig. 8**) but in the near infrared (NIR), it has a distinctive absorption peak near 977 nm [4]. This specific absorbance band, in a spectral region where most biological molecules have little or no absorbance, can be used to measure the pathlength of light through an aqueous sample [3, 5, 6].

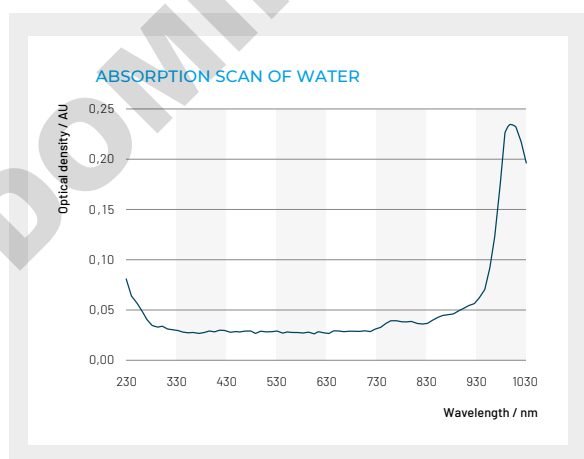

Figure 8: Absorption scan of water

Since the absorbance (i.e. optical density) of water $A_{reference}$ for the pathlength of 1 cm $d_{reference}$ can be determined in a measurement in a standard cuvette or in a measurement in a reference well of the used microplate, filled with water equivalent to 1 cm pathlength, it can be used as a reference.

The absorbance of water $A_{reference}$ can be set in relation to the absorbance of the sample A_{sample} leading to the actual pathlength of the sample d_{sample} .

$$d_{sample} = \frac{A_{sample}}{A_{reference}} \cdot 1 \text{ cm} \quad [9]$$

d_{sample} Unknown pathlength of the sample
 A_{sample} Absorption of aqueous sample with unknown pathlength d_{sample}
 $A_{reference}$ Absorption of water (reference) with 1 cm pathlength

As the absorption of water is temperature dependent, sample measurements may be subject to error if they are not made at exactly the same temperature as the reference. To avoid these errors, reference measurements can be conducted at or near 1000 nm (e.g. 997 nm). At this wavelength, the isosbestic point of water, the temperature has a minor influence on the absorbance of water [3, 5]. Nevertheless, 977 nm is close enough to the isosbestic point to get decent reduction of the temperature dependence.

For a more precise measurement the background of the aqueous sample should be considered by deducting the absorption at 900 nm. So **equation (9)** may be modified to:

$$d_{sample} = \frac{(A_{977} - A_{900})_{sample}}{(A_{977} - A_{900})_{reference}} \cdot 1 \text{ cm} \quad [10]$$

d_{sample}	Unknown pathlength of the sample 1 cm pathlength
$(A_{977} - A_{900})_{\text{sample}}$	Difference of the absorption of aqueous sample with unknown pathlength d_{sample} measured at 977 nm and 900 nm
$(A_{977} - A_{900})_{\text{reference}}$	Difference of the absorption of water (reference) with 1 cm pathlength measured at 977 nm and 900 nm

In parallel to the absorption measurement at 977/997 nm and 900 nm the absorption ($A_{\lambda \text{ sample}}$) of the aqueous sample should be measured at the wavelength λ whereas λ is defined as the specific wavelength necessary for the determination of the concentration of the substance (i.e. for DNA the wavelength of detection is 260 nm).

With the determined pathlength of the sample (d_{sample}), the absorption of the sample ($A_{\lambda \text{ sample}}$) can be corrected to 1 cm ($A_{\lambda \text{ sample } 1\text{cm}}$) as follows:

$$A_{\lambda \text{ sample } 1\text{cm}} = \frac{A_{\text{sample}} \cdot 1\text{cm}}{d_{\text{sample}}} \quad [11]$$

$A_{\lambda \text{ sample } 1\text{cm}}$	Absorbance of substance to be measured at specific wavelength λ corrected to 1 cm
$A_{\lambda \text{ sample}}$	Absorbance of the sample at the specific wavelength λ
d_{sample}	Determined pathlength of the sample

EXAMPLE 5:

In example 5 the calculation for the concentration of double stranded DNA using the pathlength correction is explained. The absorption of an aqueous DNA sample of 100 μl in a well of a half area microplate (Item No. 675801) at 977 nm was 0.15 AU, the background

at 900 nm was 0.04 AU. The absorption of the reference (water) was 0.24 AU at 977 nm and the background at 900 nm was 0.06 AU. The absorption of the sample at 260 nm was 0.47 AU, and the background 0.07 AU.

$$(A_{977} - A_{900})_{\text{sample}} = 0.15 - 0.04 = 0.11$$

$$(A_{977} - A_{900})_{\text{reference}} = 0.24 - 0.06 = 0.18$$

$$A_{\lambda \text{ sample}} = 0.47 - 0.07 = 0.40$$

Using **equation (10)** the pathlength of the sample can be determined:

$$\begin{aligned} d_{\text{sample}} &= \frac{(A_{977} - A_{900})_{\text{sample}}}{(A_{977} - A_{900})_{\text{reference}}} \cdot 1\text{cm} \quad [10] \\ &= \frac{0,11}{0,18} \cdot 1\text{cm} \\ &= \mathbf{0.61\text{cm}} \end{aligned}$$

Using **equation (11)** the optical density of the sample can be corrected to 1 cm:

$$\begin{aligned} A_{\lambda \text{ sample } 1\text{cm}} &= \frac{A_{\lambda \text{ sample}} \cdot 1\text{cm}}{d_{\text{sample}}} \quad [11] \\ &= \frac{0,40 \cdot 1\text{cm}}{0,61} \\ &= \mathbf{0.66} \end{aligned}$$

Using the standard coefficient and **equation (5)** the final DNA concentration of the sample can be calculated:

$$\begin{aligned} \text{Concentration of sample} & \quad [5] \\ &= \text{OD} \cdot \text{sc} \cdot f \\ &= 0.66 \cdot 50 \mu\text{g/ml} \cdot 1 \\ &= \mathbf{33 \mu\text{g/ml}} \end{aligned}$$

3.1.3/ MICROPLATE READERS WITH PATHLENGTH CORRECTION

In 1994 Molecular Devices Inc. (Sunnyvale, CA, USA; www.moleculardevices.com) introduced a new microplate reader equipped with a monochromator, rather than bandpass filters, for flexible wavelength selection [5].

Another monochromator based reader, the PowerWave™, was introduced by BioTek Instruments Inc. (Winooski, VT, USA; www.biotek.com) [6]. The innovative technology of both readers facilitated readouts below 340 nm and supported the high-throughput measurement of nucleic acids and proteins in microplates, in tandem with the increasing importance of genomic and proteomic research projects.

Both manufacturers supply software programs to enable a pathlength correction to 1 cm. The basis of the pathlength correction in both devices is a reference measurement of the absorbance of water in the near infrared (NIR) as described in section 3.1.2.

The usage of a device with an integrated software program is certainly the most popular and most convenient method to determine the absorbance of a sample at 1 cm. More information about the reader technology of Molecular Devices Inc. and BioTek Instruments Inc. can be found on their websites and in application notes [5, 6].

3.1.4/ STANDARD CURVE ON THE BASIS OF CALIBRATED STANDARDS

Finally, the most classical method to determine the concentration of a sample in UV/VIS spectroscopy is the implementation of references to establish a standard curve. Calibrated standards with known concentrations are used to create a straight line (Fig. 9). If the sample volume remains constant for all measurements, the pathlength has not to be considered for this type of calibrated standard determination. In addition, determinations made from both cuvettes and microplates will give the same results when the same standards are used (Fig. 9, Table 5). The advantage of this method is obvious: No special devices, optical filters, monochromators or complicated and time consuming calculations are necessary. The method is simple and precise.

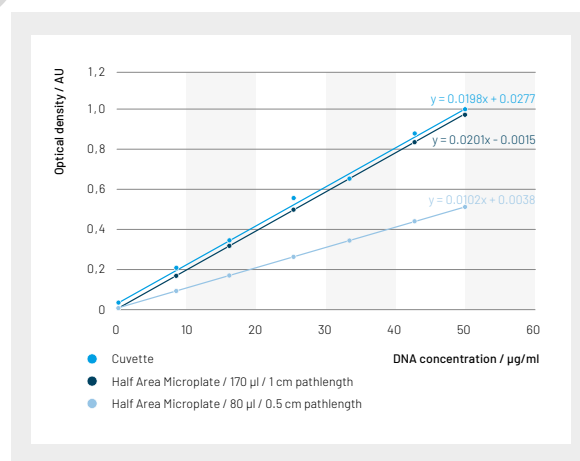

Figure 9: The measurement of DNA based on calibrated standards

	Cuvette	Half Area 170 µl	Half Area 80 µl
Optical density [y]	0.668	0.669	0.342
Linear regression	$X = \frac{Y + 0.0015}{0.0201}$	$X = \frac{Y - 0.0277}{0.0198}$	$X = \frac{Y - 0.0038}{0.0102}$
DNA concentration [x]	33 µg/ml	32 µg/ml	33 µl/ml

Table 5: Determination of DNA concentrations in half area microplates (Item No. 675801) and quartz glass cuvettes based on calibrated standards (Fig. 9)

4/ CONCLUSION

The various strategies described in this application note to measure and calculate unknown DNA concentrations of aqueous samples all yielded results of sufficient accuracy for daily laboratory work, with only negligible differences between results obtained with microplates vs. cuvettes (**Table 6**).

	DNA concentration
Mathematical approach, Half Area Microplate (Item No. 675801)	36 µg/ml
Pathlength correction, Half Area Microplate (Item No. 675801)	33 µg/ml
Calibration standards, 1 cm pathlength, Half Area Microplate (Item No. 675801)	32 µg/ml
Calibration standards, quartz glass cuvette	33 µg/ml

Table 6: Comparison of results based on the mathematical approach (section 3.1.1), pathlength correction (section 3.1.2) and calibration standards (section 3.1.4)

Compared to measurements with cuvettes, microplates allow the measurement of many samples in parallel with sample volumes down to 30 µl. The samples can be easily retrieved and even stored within the microplates. Therefore disposable microplates offer an ideal alternative to expensive and fragile quartz glass cuvettes or quartz glass microplates.

REFERENCES

1. Bock R. M., N.S. Ling, D.A. Morell, S.H. Lipton: Ultraviolet Absorption Spectra of Adenosin-5'-Triphosphate and Related 5'-Ribonucleotides. *Archives of Biochemistry and Biophysics* (1952): 62, 253-264.
2. Willfinger W. W.: Effect of pH and Ionic Strength on the Spectrophotometric Assessment of Nucleic Acid Purity. *BioTechniques* (1997), Vol. 22, No. 3; 474-481.
3. Mc Gown E. L.: UV Absorbance Measurements of DNA in Microplates. *BioTechniques* (2000): Vol. 28, No.1, 60-64.
4. Palmer K. F. and D. Williams: Optical properties of water in the near infrared. *Journal of the Optical Society of America* (1974): 64, 1107-1110.
5. Making optical density measurements automatically corrected to a 1 cm pathlength in the SPECTRAmax® Plus Microplate spectrophotometer. (The three P's of Pathcheck™: Principles, Procedures and Precautions. Molecular Devices Corporation. Application Note 25.
6. Rieger, A. and P. G. Held: Quantifizierung von Nukleinsäuren und Proteinen im Microplate-Format. *GIT Laborfachzeitschrift* (9/2001): 898-902.

making a difference

www.gbo.com

GREINER BIO-ONE GMBH
FRICKENHAUSEN, GERMANY

PHONE +49 7022 948-0
FAX +49 7022 948-514
E-MAIL info@de.gbo.com



GREINER BIO-ONE IS A GLOBAL PLAYER.
FIND THE CONTACT DETAILS OF YOUR
LOCAL PARTNER ON OUR WEBSITE.



Devices of Greiner Bio-One are to be used by properly qualified persons only in accordance with the relevant Instructions for Use (IFU), where applicable. For more information contact your local Greiner Bio-One sales representative or visit our website (www.gbo.com).

All information is provided without guarantee despite careful processing. Any liability, warranty or guarantee of Greiner Bio-One GmbH is excluded. All rights, errors and changes are reserved. If not stated otherwise, Greiner Bio-One GmbH has all copyrights and/or other (user-)rights in this documents, in particular to signs such as the mentioned (word-picture-)brands and logos. Any use, duplication or any other use of the rights of Greiner Bio-One GmbH is expressly prohibited.
Media owner: Greiner Bio-One GmbH / Represented by Managing Directors Jakob Breuer and Heinz Schmid. The company is registered in the Commercial Register at the first instance court in Stuttgart, HRB 224604 / VAT Number: DE812585719.

F073041 AN UV Spectroscopy english [Rev.12.2021]

greiner
BIO-ONE