

Valid for Item-No.: 781061, 781101, 781162, 781165, 781182, 781185, 781186

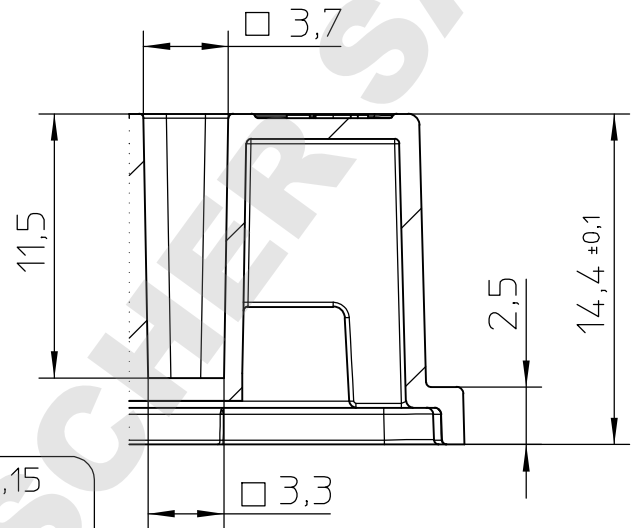

Curvature +0,15
-0,15

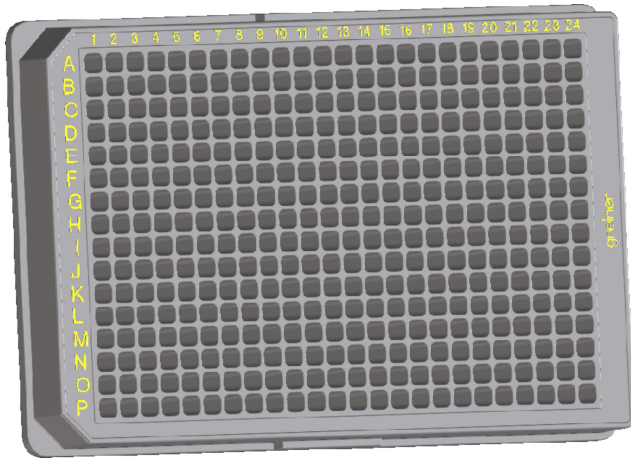
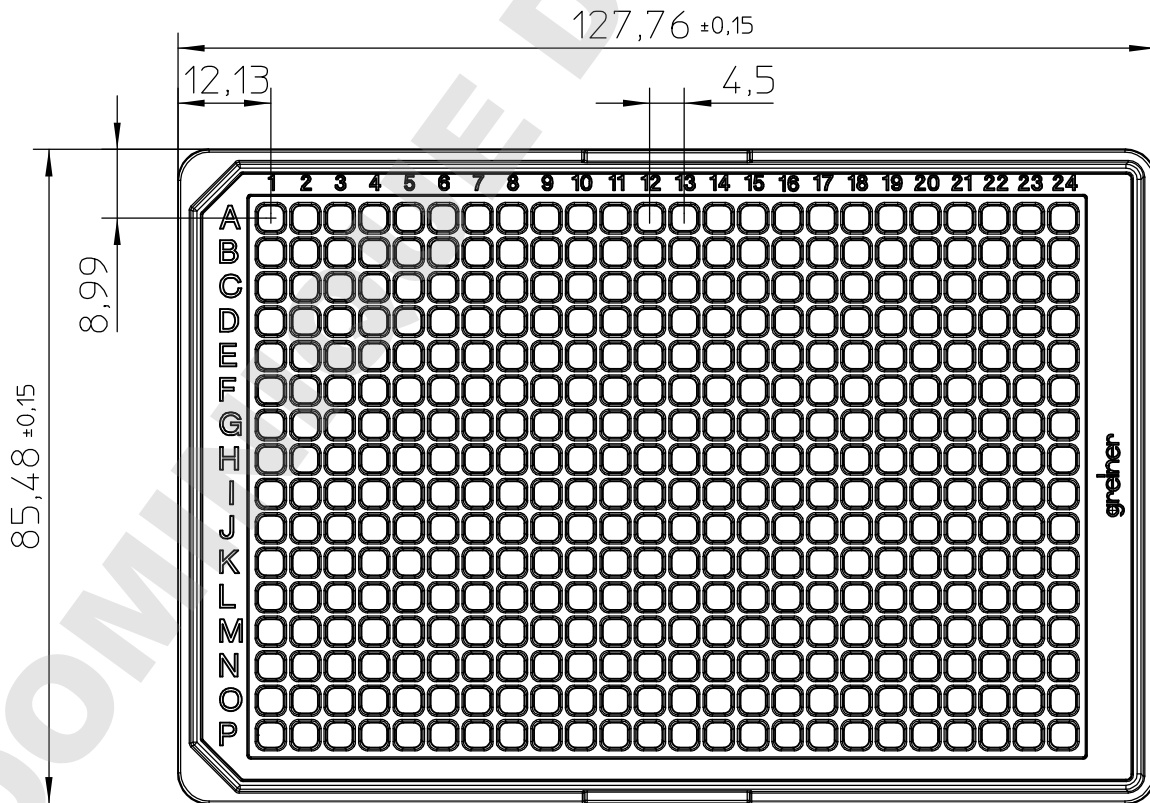
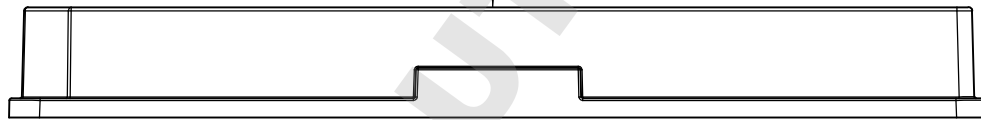

"All dimensions in mm"

Customer drawing subject to change without notice!

Uncontrolled Copy

Prior Issue	Drawn	Approved	Released	CONFIDENTIAL: Information contained in this document or drawing is confidential and proprietary to Greiner Bio-One GmbH. This document may not be reproduced for any reason without written permission from Greiner Bio-One GmbH. All rights of design, invention, and copyright are reserved.
Revision 1	Date 2014/04/29	Date 2015/01/23	Date 2015/01/23	
Date 2014/04/29	Name schwarzj	Name schwarzj	Name sonntag	

Valid for Item-No.: 781061, 781101, 781162, 781165, 781182, 781185, 781186

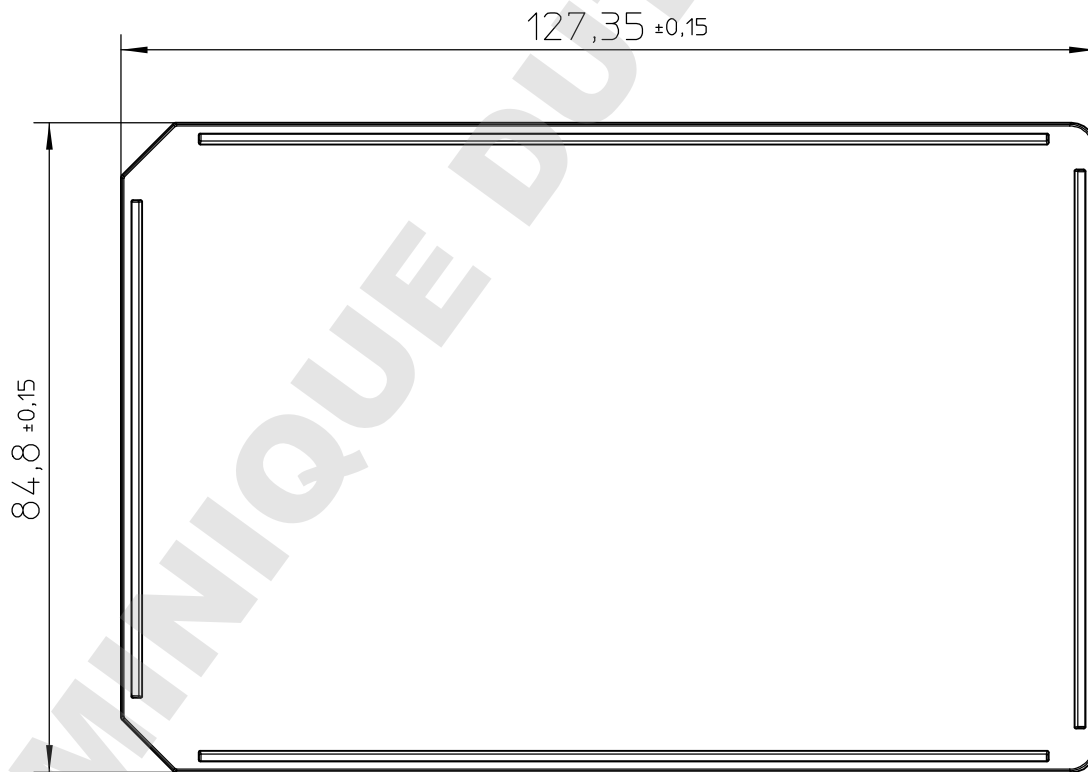
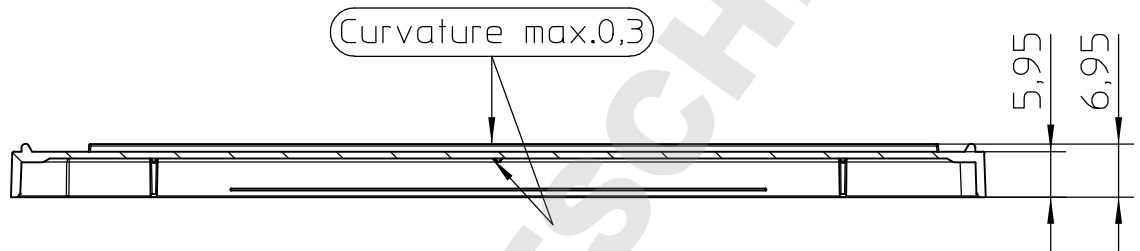
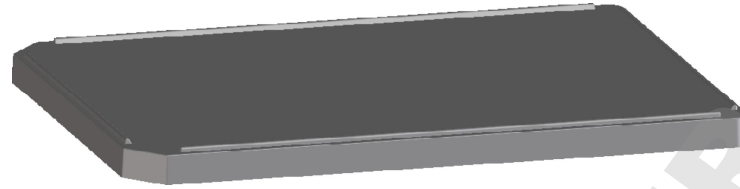

Only Item-No. 781182, 781185, 781186 with lid

"All dimensions in mm"

Customer drawing subject to change without notice!

Uncontrolled Copy

Prior Issue	Drawn	Approved	Released	CONFIDENTIAL: Information contained in this document or drawing is confidential and proprietary to Greiner Bio-One GmbH. This document may not be reproduced for any reason without written permission from Greiner Bio-One GmbH. All rights of design, invention, and copyright are reserved.
Revision	Date	Date	Date	
1	2014/04/29	2015/01/23	2015/01/23	
Date	Name	Name	Name	
2014/04/29	schwarzj	schwarzj	sonntag	