

Curvature +0,2
-0,15

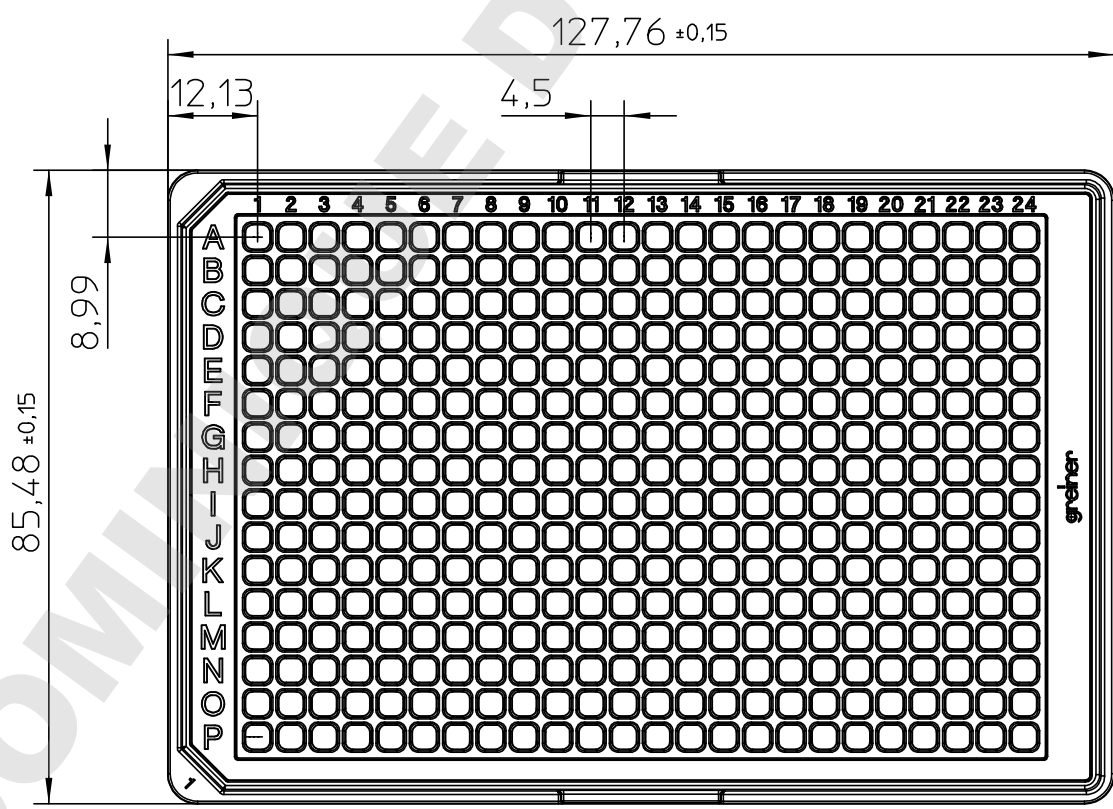
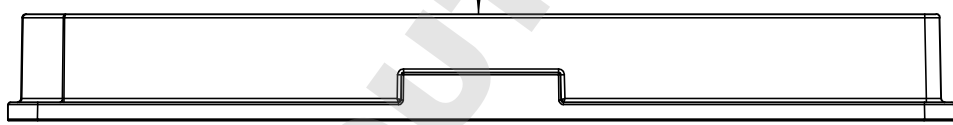

"All dimensions in mm"
Customer drawing subject to change without notice!

Uncontrolled Copy

Prior Issue	Drawn	Approved	Released	CONFIDENTIAL: Information contained in this document or drawing is confidential and proprietary to Greiner Bio-One GmbH. This document may not be reproduced for any reason without written permission from Greiner Bio-One GmbH. All rights of design, invention, and copyright are reserved.
Revision 3	Date 2011/06/30	Date 2015/01/23	Date 2015/01/23	
Date 2014/05/05	Name forb	Name schwarzj	Name sonntag	

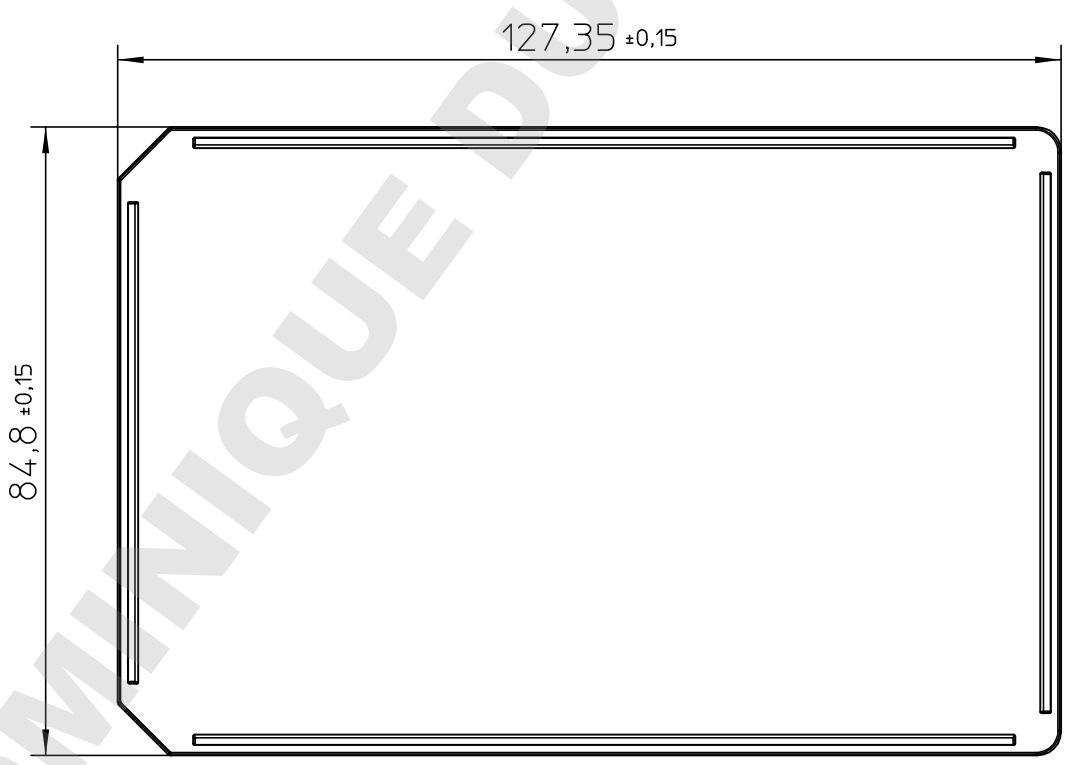
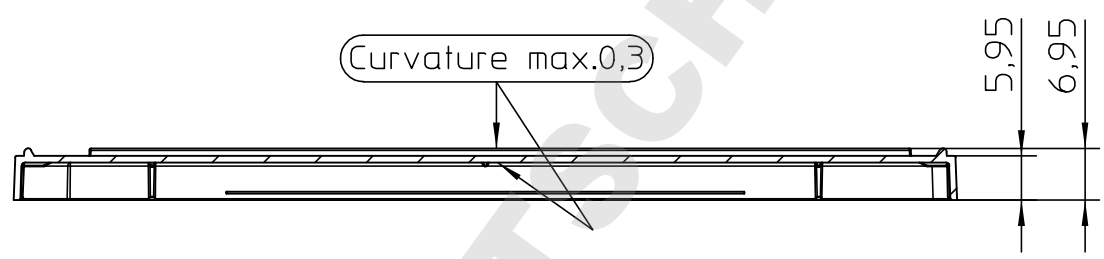
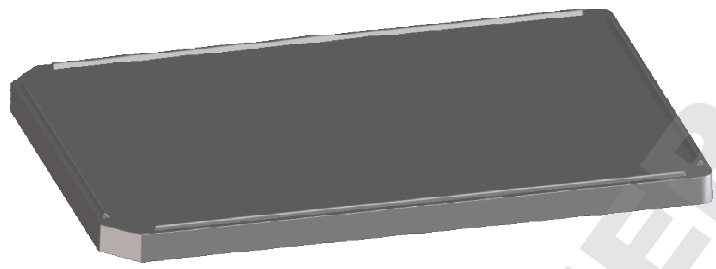

"All dimensions in mm"
Customer drawing subject to change without notice!

Uncontrolled Copy

Prior Issue	Drawn	Approved	Released	CONFIDENTIAL: Information contained in this document or drawing is confidential and proprietary to Greiner Bio-One GmbH. This document may not be reproduced for any reason without written permission from Greiner Bio-One GmbH. All rights of design, invention, and copyright are reserved.
Revision 3	Date 2011/06/30	Date 2015/01/23	Date 2015/01/23	
Date 2014/05/05	Name forb	Name schwarzj	Name sonntag	