

Valid for Item-No.: 781090, 781091, 781092, 781093, 781094, 781095, 781096, 781097, 781098

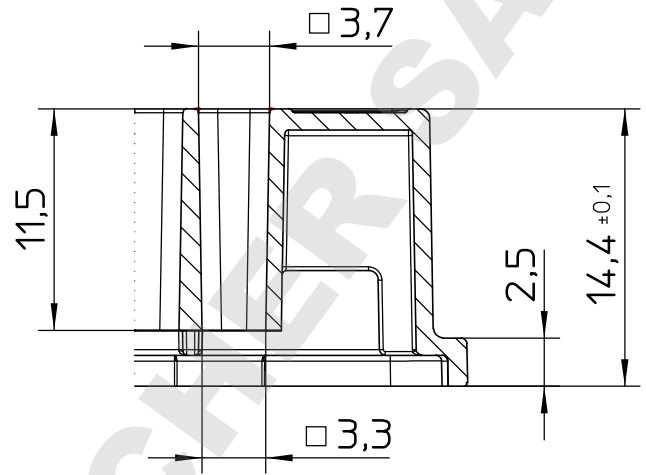

Curvature +0,2
-0,15

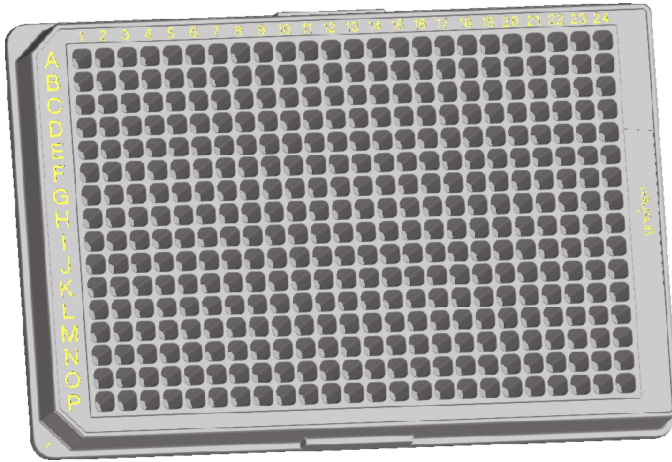
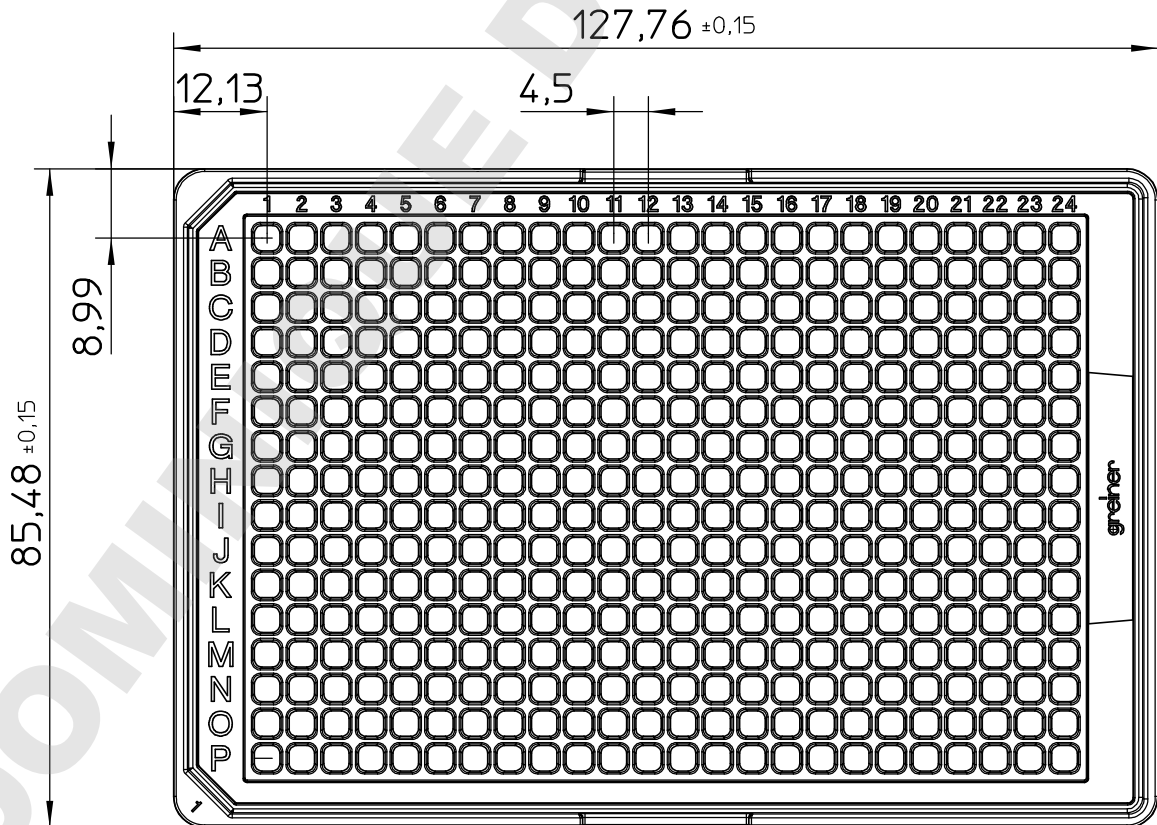
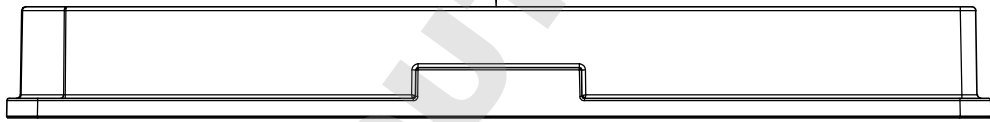

"All dimensions in mm"

Customer drawing subject to change without notice!

Uncontrolled Copy

Prior Issue	Drawn	Approved	Released	CONFIDENTIAL: Information contained in this document or drawing is confidential and proprietary to Greiner Bio-One GmbH. This document may not be reproduced for any reason without written permission from Greiner Bio-One GmbH. All rights of design, invention, and copyright are reserved.
Revision 4	Date 2011/06/30	Date 2017/01/31	Date 2017/01/31	
Date 2015/01/23	Name forb	Name schwarzj	Name sonntag	

Valid for Item-No.: 781090, 781091, 781092, 781093, 781094, 781095, 781096, 781097, 781098

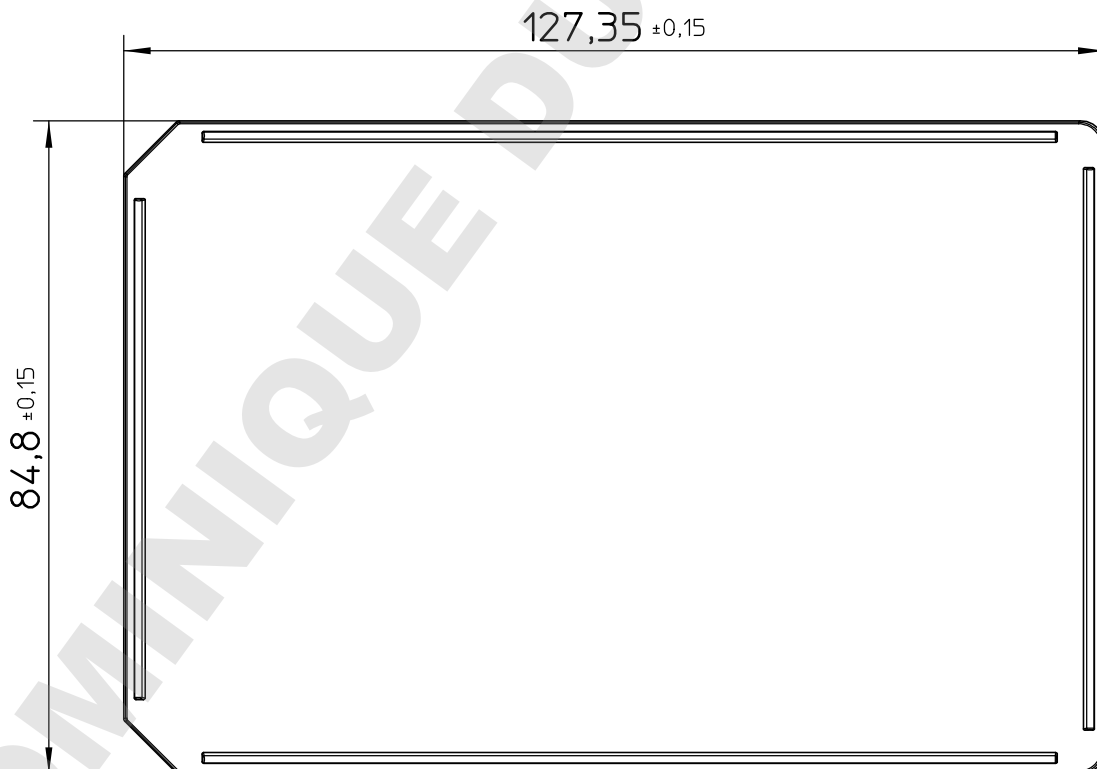
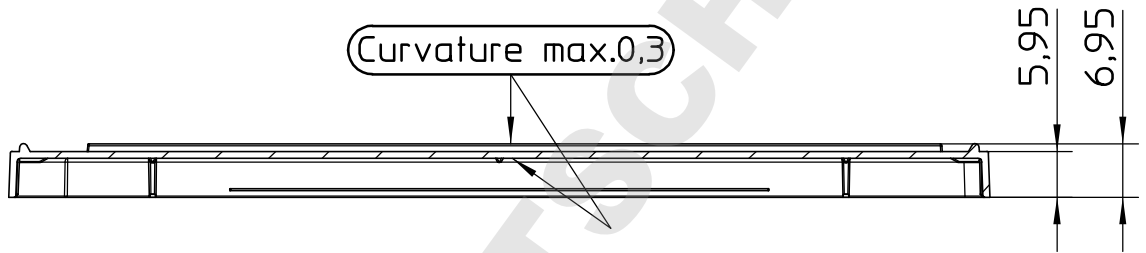
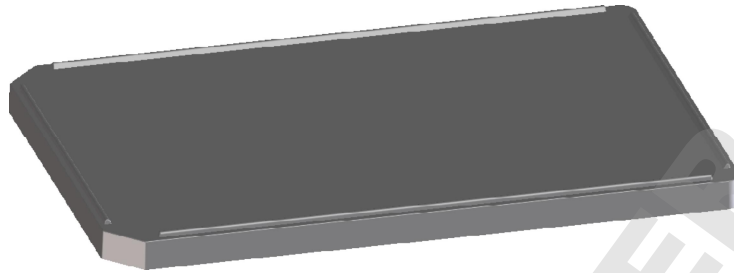

"All dimensions in mm"

Customer drawing subject to change without notice!

Uncontrolled Copy

Prior Issue	Drawn	Approved	Released	CONFIDENTIAL: Information contained in this document or drawing is confidential and proprietary to Greiner Bio-One GmbH. This document may not be reproduced for any reason without written permission from Greiner Bio-One GmbH. All rights of design, invention, and copyright are reserved.
Revision 4	Date 2011/06/30	Date 2017/01/31	Date 2017/01/31	
Date 2015/01/23	Name forb	Name schwarzj	Name sonntag	