

Valid for Item-No.: 781073, 781074, 781075, 781076, 781077, 781079, 781080, 781086

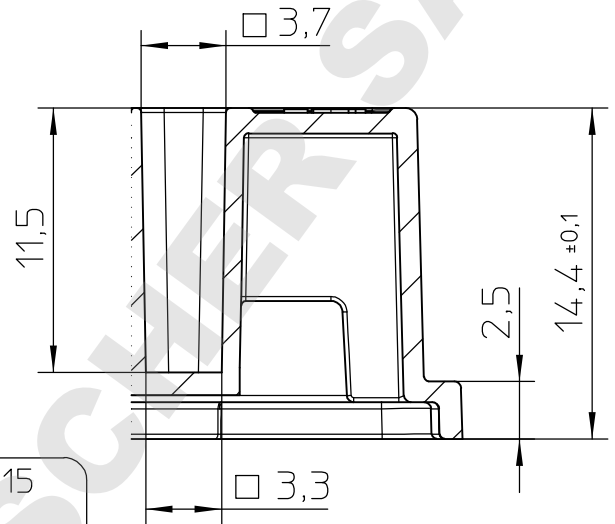

Curvature +0,15  
-0,15

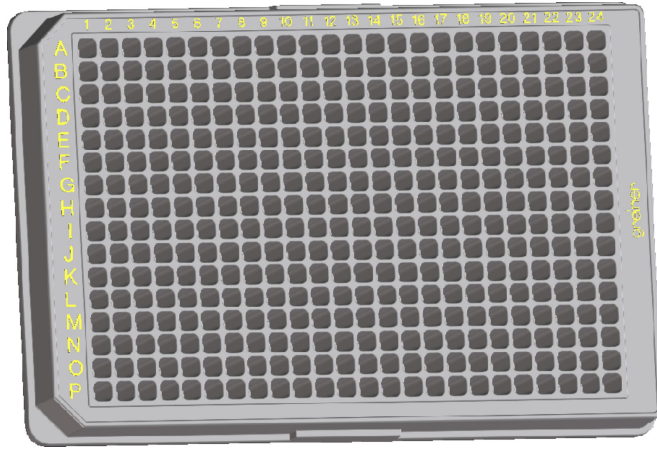
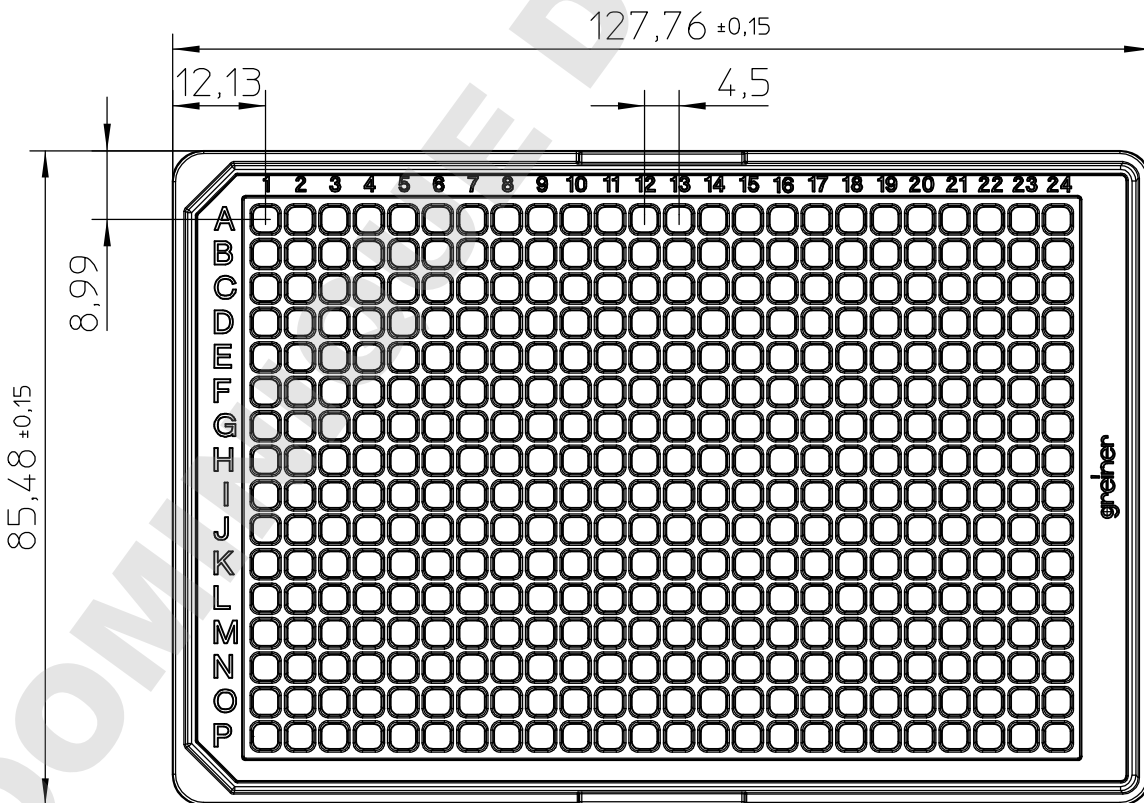
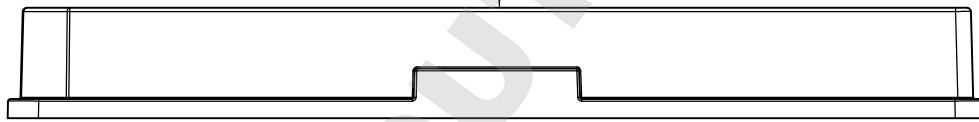

"All dimensions in mm"

Customer drawing subject to change without notice!

Uncontrolled Copy

Prior Issue	Drawn	Approved	Released	CONFIDENTIAL: Information contained in this document or drawing is confidential and proprietary to Greiner Bio-One GmbH. This document may not be reproduced for any reason without written permission from Greiner Bio-One GmbH. All rights of design, invention, and copyright are reserved.
Revision	Date	Date	Date	
3	2011/03/23	2015/01/23	2015/01/23	
Date	Name	Name	Name	
2014/04/29	forb	schwarzj	sonntag	

Valid for Item-No.: 781073, 781074, 781075, 781076, 781077, 781079, 781080, 781086

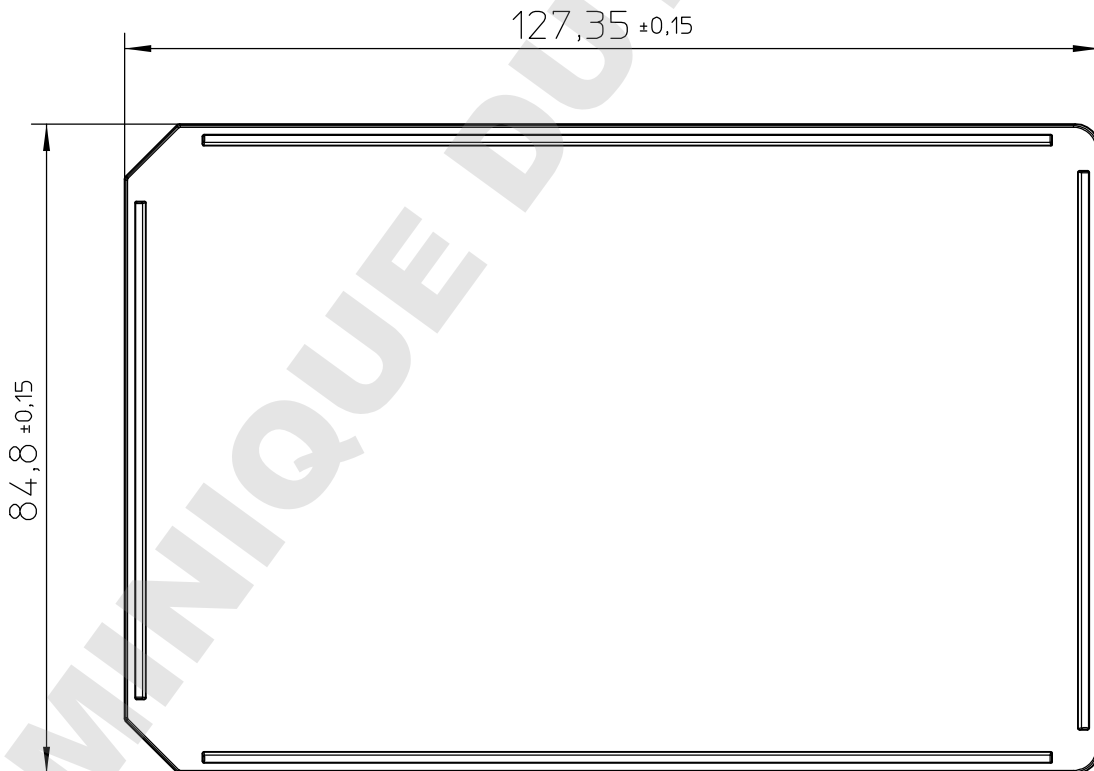
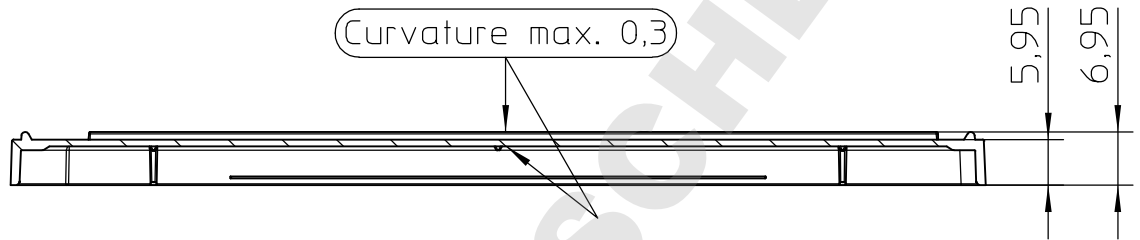
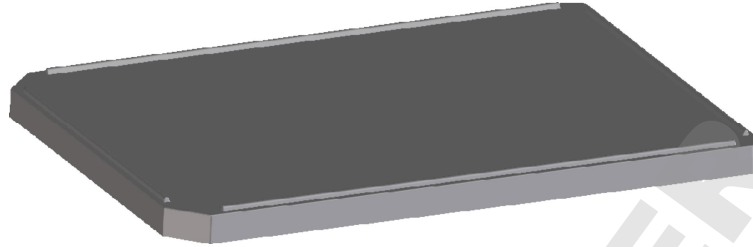

Only Item-No. 781080, 781086 with lid

"All dimensions in mm"

Customer drawing subject to change without notice!

Uncontrolled Copy

Prior Issue	Drawn	Approved	Released	CONFIDENTIAL: Information contained in this document or drawing is confidential and proprietary to Greiner Bio-One GmbH. This document may not be reproduced for any reason without written permission from Greiner Bio-One GmbH. All rights of design, invention, and copyright are reserved.
Revision 3	Date 2011/03/23	Date 2015/01/23	Date 2015/01/23	
Date 2014/04/29	Name forb	Name schwarzj	Name sonntag	