



Titration

TITRATORS, SAMPLE CHANGERS, SOFTWARE AND ELECTRODES

SI Analytics

a xylem brand

Content

1. Overview	Page 4
1.1 Selection table	Page 10
2. Applications overview	Page 12
3. Burettes and Titrators	
3.1 TITRONIC® 300	Page 14
3.2 TitroLine® 5000	Page 16
3.3 Specifications and ordering information TITRONIC® 300 and TitroLine® 5000	Page 18
4. Burettes and Titrators with interchangeable unit	
4.1 TITRONIC® 500	Page 20
4.2 TitroLine® 7000	Page 22
4.3 Karl Fischer Titration	Page 26
4.4 TitroLine® 7500 KF and TitroLine® 7500 KF trace	Page 28
4.5 TitroLine® 7750	Page 30
4.6 TitroLine® 7800	Page 32
4.7 Specifications TITRONIC® 500 and TitroLine® 7000/7500/7750/7800	Page 36
4.8 Ordering information TITRONIC® 500 and TitroLine® 7000/7500/7750/7800	Page 40
5. Sample changers and accessories	
5.1 Sample changer TW alpha plus	Page 42
5.2 Sample changer TW 7400	Page 44
5.3 Ordering information TW alpha plus and TW 7400 and accessories	Page 46
6. Titration software TitrSoft	
6.1 TitrSoft 3.3	Page 48
6.2 TitrSoft 3.3P	Page 52
6.3 Ordering information TitrSoft 3.3 / 3.3P	Page 53
6.4 Parallel Titration with TitroLine® 7800 and TitrSoft	Page 55
7. Electrodes for Titration	Page 56
8. Tips for successful measurement with pH and ORP electrodes	Page 92
9. More SI Analytics products	Page 106
10. About us	Page 110

1. The world of titration

Our titrators

TitroLine® 5000, 7000, 7750, 7500 KF, 7500 KF trace, 7800 and the TITRONIC® 300 and 500 piston burettes with innovative features for simple and easy operation.

- High visibility, full color display that can be easily viewed from a distance and at extreme angles.
- Reagent data is securely stored in the intelligent and interchangeable modules (not: TITRONIC® 300 and TitroLine® 5000).
- Automatic wireless recognition of SI Analytics ID electrodes and IDS interface (TitroLine® 7800) guarantee accurate calibration and measurements
- Includes up to three USB, one LAN and two RS232 ports for expansion and connection of devices such as USB storage of methods and data, stirrer, laboratory balance, PC and more peripheral devices.
- Export the results as PDF or CSV, also to networks.
- Transfer of methods via USB device.

Advantages
TitroLine® / TITRONIC®



TITRONIC® 500
TitroLine® 7000 / 7750 / 7800



TitroLine® 5000
TITRONIC® 300



TitroLine® 7500 KF
TitroLine® 7500 KF trace



Titrators/Burettes

Loaded with features

High visibility graphic display

- ▶ Exceptional high visibility graphic display for viewing even at extreme angles.
- ▶ Clear graphic representation of titration curves and the first derivative curve (TitrLine®).
- ▶ Equivalence point values are displayed in the titration curve (TitrLine®).

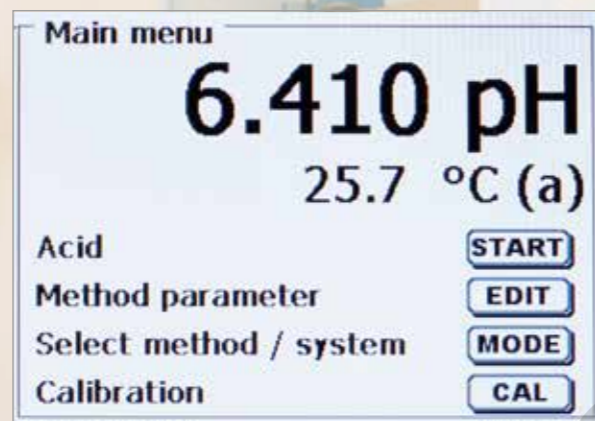
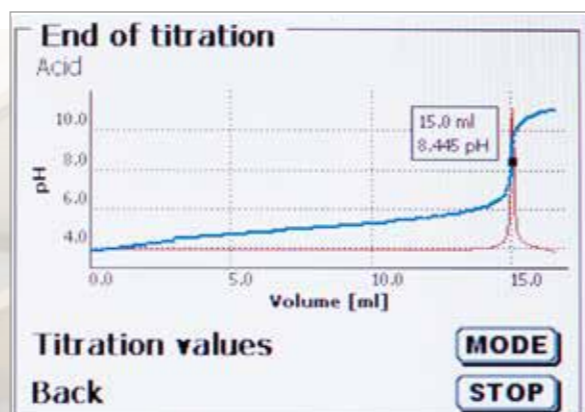

Intelligent, interchangeable modules (except: T300/TL5000/TL7500 KF trace)

- ▶ Size options of 5, 10, 20 and 50 ml.
- ▶ Compact, space saving footprint.
- ▶ All relevant reagent and unit data are stored in the integrated RFID-chip including:
 - Burette size (ml)
 - Titrant name
 - Titrant concentration or titer value of solution
 - Date of manufacture or expiration date of the reagent.



Titration/Burettes

Flexible configuration features

Expand and customize your workstation using up to three USB, one LAN and two RS232 ports for a total of five connection options for:

- Magnetic stirrer TM 235 and USB mouse
- USB printer (Standard A4 HP-PCL) and compact printer TZ3863
- USB keyboard
- Network
- Barcode reader
- USB storage device and hub
- Balance and PC
- other SI Analytics devices

USB printer A4 format



Thermo printer DPU S445



USB manual controller



Keyboard

Loaded with innovative features

Standard methods:

- Each piston burette or titrator has already pre-installed standard methods
- The standard methods are loaded and can be used, but also modified.
- The preinstalled standard method will always stay retained and can be re-installed at any time.

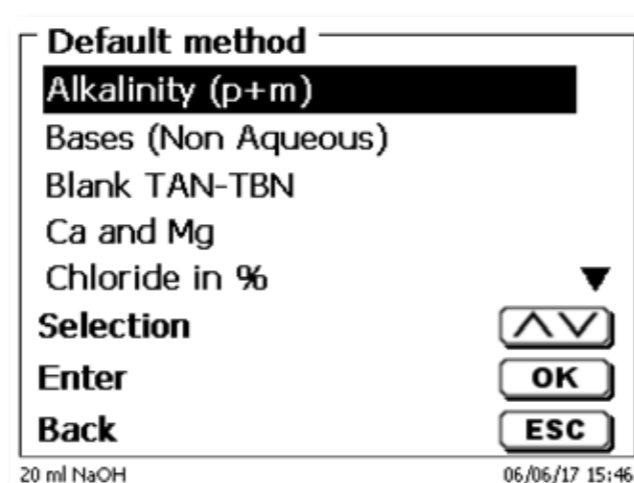
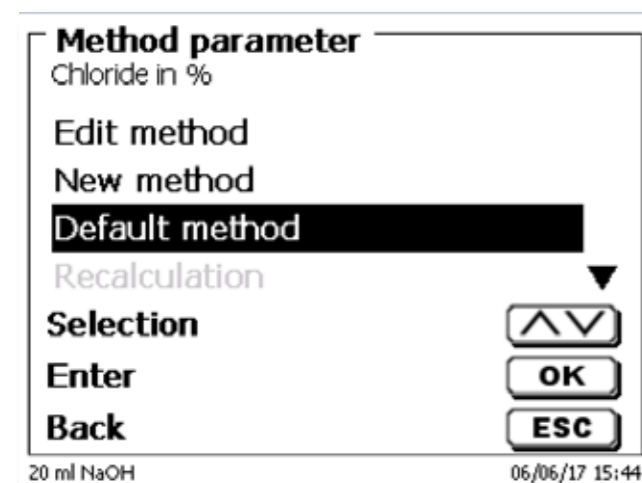

Documentation:

- The results are documented on a USB device in PDF and CSV format.
- The results can also be printed on a DIN A 4 (color or b / w) or on a thermal printer.
- The printer can be connected directly to the titrator / piston burette, or it can be printed via a network printer.
- When connected to a network, the PDF and CSV files can be stored in a shared directory.

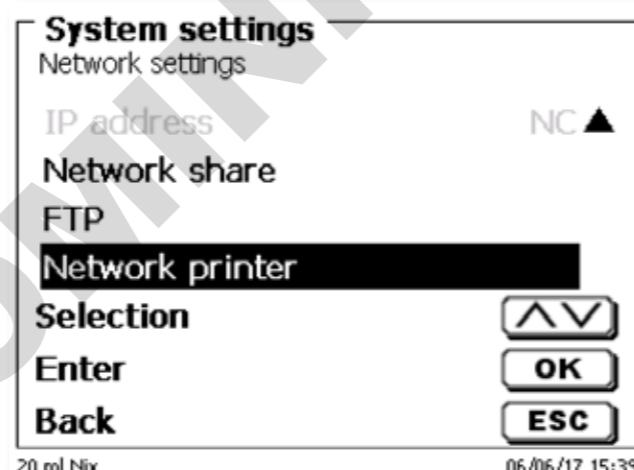
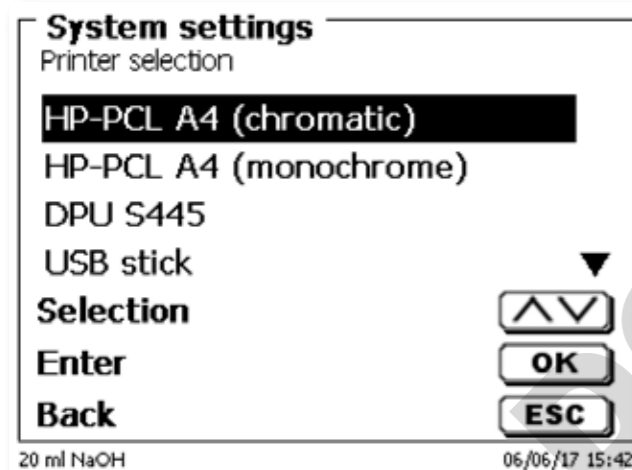

Formula editor

- The Formula editor allows the use of individual calculations.
- Select one of the standard formulas and modify them if necessary.
- In addition to a number of units (%,, g / l ...) you can also assign an individual unit.
- Results (titre, blank value, etc.) can be automatically written to global memory and reused later.

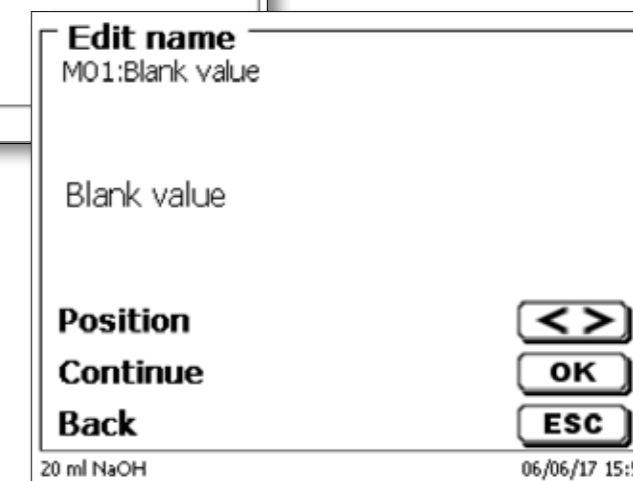
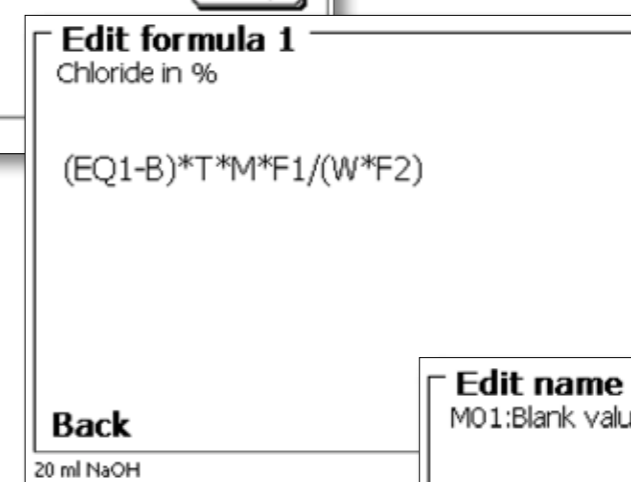
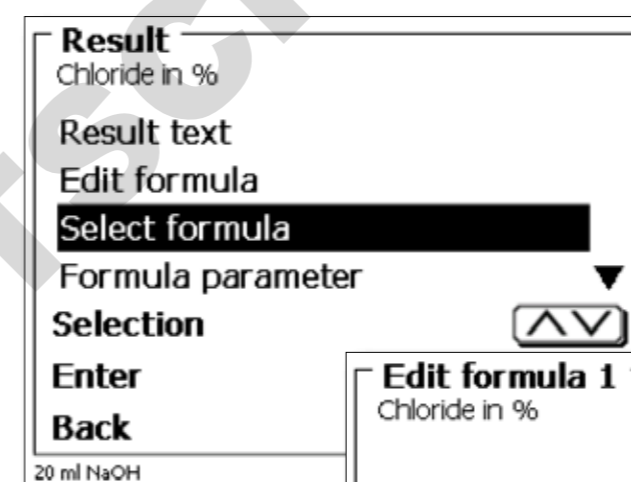

1.1 Selection table titration-

The most important features of titrators TitroLine®

TITRONIC® and TitroLine®
and piston burettes TITRONIC® at a glance

Application	TITRONIC® 300	TITRONIC® 500	TitroLine® 5000	TitroLine® 7000	TitroLine® 7500 KF	TitroLine® 7500 KF trace	TitroLine® 7750	TitroLine® 7800
Intelligent interchangeable units (5, 10, 20 and 50 ml)	1)	■	1)	■	■	—	■	■
Manual titration	■	■	■	■	—	—	■	■
Dosing	■	■	■	■	■	—	■	■
Solutions preparation (manually or automatically with connected balance)	—	■	—	■	■	—	■	■
Automatic titration (independent with external software)	2)	2)	■	■	■	■	■	■
Applications with TitrSoft	■	■	—	■	■	■	■	■
pH-stat-applications (enzyme kinetics, soil samples, biotechnology)	—	—	—	■	—	—	■	■
Applications with sample changer	—	—	—	■	—	—	■	■
pH/mV titrations „aqueous“ (Alkalinity, hydrochloric acid, citric acid, Kjeldahl...)	—	—	■	■	—	—	■	■
pH/mV titrations „non aqueous“ (TAN/TBN, FFA, titrations with perchloric acid...)	—	—	—	■	—	—	■	■
Redox titrations (iodometry, permanganometry...)	—	—	■	■	—	—	■	■
Redox titrations (COD)	—	—	■	■	—	—	■	■
Halide titrations (chloride, "salt"...)	—	—	■	■	—	—	■	■
Hydrogen sulphide and mercaptans	—	—	—	■	—	—	■	■
Sulfurous acid in wine and beverages	—	—	—	■	■	—	■	■
Bromine number	—	—	—	■	■	■	■	■
Water analysis according to KF Volumetric method (10 ppm - 100%)	—	—	—	—	■	—	■	■
Water analysis according to KF Coulometric method (1 ppm - 5%)	—	—	—	—	—	■	—	—
Measuring two parameters at the same time (e.g. pH and Cond)	—	—	—	—	—	—	—	■
Photometric titration (OptiLine 6)	—	—	—	■	—	—	■	■

1) 20 and 50 ml dosing unit usable (no intelligent interchangeable units)
2) Can be used as titration and dosing burette in automatic titration systems

Titrators/Burettes

2. Applications Overview (examples)



Water and Wastewater Analysis

Application	TitroLine® 5000	TitroLine® 7000 / 7750	TitroLine® 7800
Alkalinity (p+m-value)	■	■	■
COD	■	■	■
Permanganate index	■	■	■
FOS/TAC	■	■	■
pH + Cond + acid capacity	■	■	■
Kjeldahl-nitrogen/ammonia (after distillation)	■	■	■
Chloride in drinking and wastewater	■	■	■
Chlorine in drinking water	■	■	■
Calcium and magnesium hardness (2 equivalence points)	■	■	■
Total hardness (Sum Ca/Mg; 1 equivalence point)	■	■	■



Food

Application	TitroLine® 5000	TitroLine® 7000 / 7750	TitroLine® 7800
Total acidity in wine and soft drinks	■	■	■
Total acidity in food (ketchup, salad dressing)	■	■	■
Ash alkalinity	■	■	■
Chloride ("salt") in food and mineral water	■	■	■
Sulfurous acid (SO ₂), free and total	■	■	■
Volatile acids	■	■	■
Titrateable acidity in milk (Soxlet Henkel (SH) index)	■	■	■
Reducing sugars	■	■	■
Ascorbic acid (vitamin C)	■	■	■
Calcium in milk and dairy products	■	■	■
Calcium and magnesium in mineral water	■	■	■
Formol index	■	■	■
Nitrite in pickling salt	■	■	■
Iodine number	■	■	■
Peroxide number	■	■	■
Saponification number	■	■	■
Acidity (FFA) in fats and oils	■	■	■

Industrial Products



Application	TitroLine® 5000	TitroLine® 7000 / 7750	TitroLine® 7800
Titration with perchloric acid (waterfree)	■	■	■
Hydroxyl number	■	■	■
NCO (Isocyanate) number	■	■	■
Epoxy number	■	■	■
Acid number in resins and other industrial products	■	■	■
Total acidity in mineral oils ("TAN")	■	■	■
Total base number ("TBN") in oils	■	■	■
Electroplating (Metals, acids, leach, etc.)	■	■	■

- Excellent application suitability
- Titration is possible for this application with restrictions and must be evaluated
- Not applicable



3.1 TITRONIC® 300 - Titrating manually, perfectly dosing

The TITRONIC® 300 is a perfect motor-driven burette for manual titration and precise dosing instrument for dispensable liquids, solvents and titrating agents.

The TITRONIC® 300 is not only a stand-alone device, but also shows its strengths in the computer-controlled „Daisy Chain“ network. Up to 16 devices can be connected one behind the other.

Manual Titration

It is true that the automatic titration is gaining ground, but manual titration remains one of the standard cost effective applications in the lab, wherever high precision and flexibility are required.

- ▶ Titration with hand controller (mouse).
- ▶ Titration rate can be adjusted in five different steps to optimize the titration speed and accuracy.
- ▶ Automatic calculation of results in different units and exportation to a printer or USB memory device.
- ▶ Automatic weight recording when a balance is connected.



Dosing

Beside the titration there are various routine dosing tasks that must be performed in the lab. A piston burette is the ideal device for precise dosing tasks:

- ▶ Adjustable dosing and filling rate for each method.
- ▶ Adjustable filling between each dose step.
- ▶ The intelligent filling function checks if a dosing step is feasible without filling in advance. This reduces faulty operations during a serial dosing process.



3.2 TitroLine® 5000 - The easiest titration ever...

The predecessor of the TitroLine® 5000, TitroLine® easy, has always been the first choice if you were looking for a very easy-to-use automatic titrator for any application. A special training or a deeper knowledge of automatic titration was not necessary to get precise and quick results. That and much more is exactly what the new TitroLine® 5000 stands for:

- ▶ High resolution pH/mV-measurement input for pH-, ORP-, silver - and further mV-electrodes
- ▶ Pt 1000 and NTC 30 temperature measurement input for automatic temperature compensation
- ▶ Pre-installed standard methods for FOS/TAC, alkalinity, total acidity in drinks, chloride etc.
- ▶ Linear and dynamic titration to equivalence points
- ▶ Titration to pH and mV-end points
- ▶ Same manual titration and dosing function as the piston burette TITRONIC® 300



Typical applications of water/wastewater and environmental analysis

- ▶ pH-value, alkalinity (p+m-value)
- ▶ FOS/TAC (see titration curve and result screen as example)
- ▶ Total Kjeldahl nitrogen
- ▶ Permanganat index and COD
- ▶ Chloride in wastewater

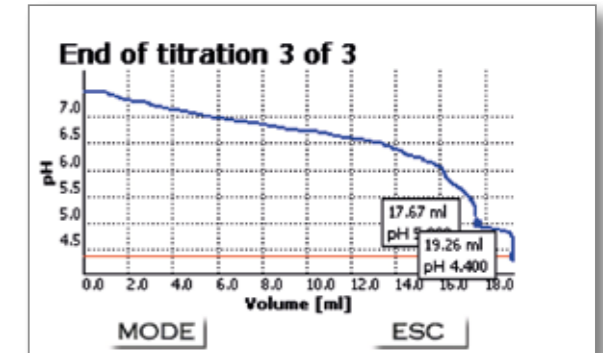

Typical applications of food analysis

- ▶ Salt content (chloride, sodium chloride, see titration curve as example)
- ▶ pH-value, total acidity in wine, drinks and other food products
- ▶ Ascorbic acid
- ▶ Protein determination (Kjeldahl-nitrogen in milk and dairy products)
- ▶ Iodine and peroxide value

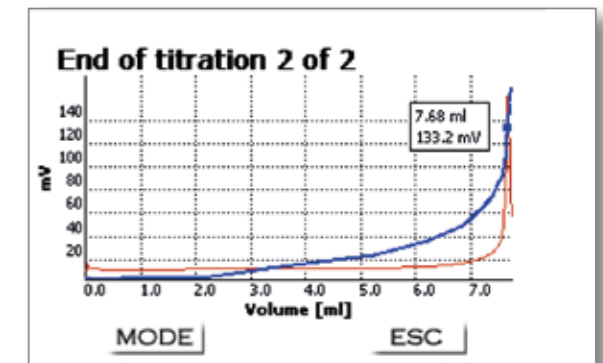

Titrators/Burettes

3.3 Specifications - TITRONIC® 300

Features	
Interfaces:	1 x USB-A and 1 x USB-B, 2 x RS-232-C
Stirrer connection:	TM 50, power supply directly through piston burette
Keyboard:	The unit is operated using the keys on the device itself, the controller TZ 3880 and optional PC-keyboard (USB)
Display:	graphics-capable TFT display.
Volume display:	0000.000...9999.999 ml
Display resolution:	0.005-0.025 ml (depending on dosing unit)
Dosing speed:	max. 100 ml/min (with 50 ml unit)
Filling speed	min 30 s to 999 s adjustable (time according to the cylinder volume)
Dosing units:	20 ml or 50 ml dosing unit, interchangeable
Burette resolution:	8000
Dosing accuracy:	systematic error 0.15 %, random error 0.05 % in compliance with EN ISO 8655-6
Power supply:	100 -240 V~; 50/60 Hz, power input 30 VA
Conformity:	ISO 8655, part 6
CE-mark:	EMC: 2004/108/EG; safety EG- Directive 2006/95
Dimensions	135 x 310 x 205 mm (W x H x D), including dosing unit, without stirrer
Weight:	2 kg (without stirrer)
Ambient conditions	Ambient temperature: + 10 ... + 40 °C for operation and storage. Humidity according to EN 61 010, Part 1:Max. relative humidity 80 % for temperatures up to 31 °C, linear decrease down to 50 % relative humidity at a temperature of 40 °

Ordering information - TITRONIC® 300

Type No.	Order No.	Description
T 300/20 M1	285225800	TITRONIC® 300 without magnetic stirrer TITRONIC 300 basic unit with ready to use assembled 20 ml dosing unit, manual controller, titration clamp, stand rod and power supply 100-240 V
T 300/50 M1	285225810	TITRONIC® 300 without magnetic stirrer TITRONIC 300 basic unit with ready to use assembled 50 ml dosing unit, manual controller TZ 3880, titration clamp, stand rod and power supply 100-240 V
T 300/20 M2	285225820	TITRONIC® 300 with magnetic stirrer TITRONIC 300 basic unit with ready to use assembled 20 ml dosing unit, magnetic stirrer TM 50, manual controller, titration clamp, stand rod and power supply 100-240 V
T 300/50 M2	285225830	TITRONIC® 300 with magnetic stirrer TITRONIC 300 basic unit with ready to use assembled 50 ml dosing unit, magnetic stirrer TM 50, manual controller, titration clamp, stand rod and power supply 100-240 V

Accessories - TITRONIC® 300

Type No.	Order No.	Description
TM 50	285225840	Magnetic stirrer
TZ 3835	285220410	USB-keyboard
TZ 3830	285220420	USB-HUB
TZ 3803	285220590	Reagent bottle, amber, 1l

Specifications - TitroLine® 5000

Features	
Measurement input pH/mV:	pH/mV-input with Electrode socket according to DIN 19 262 or additional with BNC socket insert (Z 860)
Measurement input temperature:Pt 1000/NTC 30:	(socket 2 x 4 mm)
Interfaces:	1 x USB-A and 1 x USB-B, 2 x RS-232-C
Stirrer connection:	TM 50 power supply directly through piston burette
Keyboard:	The unit is operated using the keys on the device itself, the controller TZ 3880 and optional PC-keyboard (USB)
Display:	graphics-capable TFT display
Volume display:	0000,000...9999,999 ml
Display resolution:	0.005-0.025 ml (depending on dosing unit)
Dosing speed:	max. 100 ml/min (with 50 ml unit)
Filling speed:	min 30 s to 999 s adjustable (time according to the cylinder volume)
Dosing units:	20 ml or 50 ml dosing unit, interchangeable
Burette resolution:	8000
Dosing accuracy:	systematic error 0.15 %, random error 0.05 % in compliance with EN ISO 8655-6
Power supply:	100 -240 V~; 50/60 Hz, power input 30 VA
Conformity:	ISO 8655, part 6
CE-mark:	EMC: 2004/108/EG; safety EG- Directive 2006/95
Dimensions:	135 x 310 x 205 mm (W x H x D), including dosing unit, without stirrer
Weight:	2.3 kg (without stirrer)
Ambient conditions:	Ambient temperature: + 10 ... + 40 °C for operation and storage. Humidity according to EN 61 010, Part 1: Max. relative humidity 80 % for temperatures up to 31 °C, linear decrease down to 50 % relative humidity at a temperature of 40 °

Ordering information - TitroLine® 5000

Type No.	Order No.	Description
TL 5000/20 M1	285225760	TitroLine® 5000 with 20 ml dosing unit Basic unit without electrode, with ready to use assembled 20 ml dosing unit, manual controller, titration clamp, stand rod, magnetic stirrer TM 50 and power supply 100-240 V
TL 5000/50 M1	285225770	TitroLine® 5000 with 50 ml dosing unit Basic unit without electrode, with ready to use assembled 50 ml dosing unit, manual controller, titration clamp, stand rod, magnetic stirrer TM 50 and power supply 100-240 V
TL 5000/20 M2	285225780	TitroLine® 5000 with 20 ml dosing unit Basic unit with pH electrode and buffer set, with ready to use assembled 20 ml dosing unit, manual controller, titration clamp, stand rod, magnetic stirrer TM 50 and power supply 100-240 V
TL 5000/50 M2	285225790	TitroLine® 5000 with 50 ml dosing unit Basic unit with pH-electrode and buffer set, with ready to use assembled 50 ml dosing unit, manual controller, titration clamp, stand rod, magnetic stirrer TM 50 and power supply 100-240 V
TL 5000/20 M3	285225850	TitroLine® 5000 with 20 ml dosing unit Basic unit with Ag-electrode, with ready to use assembled 20 ml dosing unit, manual controller, titration clamp, stand rod, magnetic stirrer TM 50 and power supply 100-240 V

Accessories - TitroLine® 5000

Type No.	Order No.	Description
TZ 3835	285220410	USB-keyboard
TZ 3830	285220420	USB-HUB
TZ 3803	285220590	Reagent bottle, amber, 1l

4.1 TITRONIC® 500: The piston burette for all situations

The TITRONIC® 500 is the ideal piston burette for manual titrations, accurate dosing applications as well as the preparation of solutions. When used with TitriSoft 3.3, it acts as a titration burette or with the TitroLine®7000 and TitriSoft 3.3, it is an automatic dosing unit perfect to pre-dose a titrant.

Important features:

- ▶ Intelligent interchangeable modules with 5, 10, 20 and 50 ml volume capacity.
- ▶ Connect to a printer and/or an analytical balance.
- ▶ Remote control access via RS232 or USB interface.
- ▶ Connect up to 16 devices using one USB or RS232 port of a PC with the two integrated RS232 interfaces (Daisy Chain).



Manual Titration

It is true that the automatic titration is gaining ground, but manual titration remains one of the standard cost effective applications in the lab. Everywhere high precision and flexibility are required; a piston burette with an interchangeable dosing module is the best choice.

Important features:

- Titration using the manual controller dosing buttons.
- Titration rate can be adjusted to optimize titration speed and accuracy.
- Programmable automatic calculations, printer ready.
- Automatic weight recording when balance is connected.

Dosing

Besides titration, there are various routine dosing tasks that must be performed in the lab.

Important features:

- Control dosing using the manual controller and the dedicated keypad.
- Adjustable dosing and filling rates optimize speed and accuracy.
- Store dosing methods with different parameters.

Solutions preparation

A special sample preparation mode is available on the TITRONIC® 500 where a reagent is dosed into a sample until the required concentration is reached. The sample is weighed, the dosing volume is determined. The volume can then be automatically added to the sample. This mode is used for e.g. preparing standard and sample solutions for viscometry.

Important features:

- Adjustable dosing and filling speed.
- Dosing volume is automatically calculated without additional PC software.
- Several methods with different parameters can be stored.
- Automatic weight recording when balance is connected.

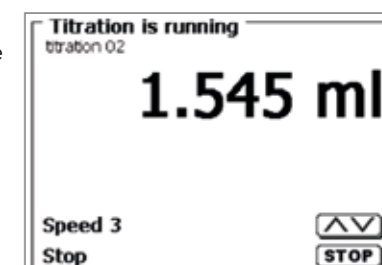

4.2 TitroLine® 7000: The professional step

With its performance spectrum, the TitroLine® 7000 is the ideal starting device for potentiometric titration with potential for expansion and automation. Thanks to the high-resolution and precise pH/ mV and "dead-stop" measuring interface, it is possible to determine a wide range of parameters quickly, reliable and accurate.

Besides the specifications of the instrument series from the general part already mentioned in the introduction and the features of the TITRONIC® 500 and TitroLine® 5000, the TitroLine® 7000 provides more:

More methods

As a rule 10-15 user methods are usually enough for the most requirements. But sometimes you need a little bit more capacity. The TitroLine® 7000 offers storages up to 50 user methods.

Measurement and calibration with the highest accuracy

...The wireless sensor recognition automatically recognizes SI Analytics® ID electrodes and instantly stores dedicated sensor data eliminating measurement and calibration errors.

Features of the TitroLine® 7000 include

- High resolution pH/mV-electrode and temperature inputs for pH, ISE, redox (ORP) or photometric titrations.
- Polarizable electrode input for set endpoint titrations („Dead-stop“)
- Linear (fixed increment) and dynamic equivalence point titration mode
- Titrations to pH/ mV and μ A-Endpoint
- Manual titration mode and routine dosing tasks are also available.



pH/mV interface for ID electrodes

Typical applications of the water/wastewater and environmental analysis:

- pH-value, alkalinity ("p+m-value")
- Permanganate index
- COD
- Volatile fatty acids/Total anorganic carbon (FOS/ TAC)
- Total nitrogen according to Kjeldahl
- Chloride in waste and drinking water
- Free and total chlorine in drinking and bathing water
- Ca/Mg-and total hardness
- Oxygen according to „Winkler“ method



Titration/Burettes

Titration application „chemical oxygen demand“ COD

Application example for food analysis: "Determination of free and total sulphurous acid (SO₂) in wine"

Since ancient times the wine is being preserved through the addition of "sulfur" (sulphurous acid).

The addition of sulphurous acid inhibits the oxidation processes and prevents the growth of unwanted microorganisms. The content of free and total sulphur (exact: sulphur dioxide) is determined through the titration of 10-50 ml sample after the addition of sulphuric acid and potassium iodide with a iodine solution (e.g. 0.025 mol/l) and using a double platinum electrode as indication electrode. The free SO₂ is titrated directly. The total SO₂ is titrated after the hydrolysis with sodium hydroxide which converts the bounded SO₂ into the free form. The method with all parameters and calculation formula is already stored as standard method in the TitroLine® 7000 and can be used directly

Typical applications of food analysis:

- Salt content (chloride, sodium chloride).
- pH-value, total acidity in wine, beverages and food products such as condiments.
- Formol number in fruit and vegetable juices.
- Ascorbic acid (Vitamin C).
- Calcium in milk and dairy products.
- Protein determination (Kjeldahl-nitrogen) in milk and dairy products.
- Reducing sugar in wine and juices.
- Iodine number, peroxide number, free fatty acids and saponification number.
- Determination of free and total sulphurous acid (H₂SO₃) in wine and must. Further detail is available in the application example.

TitroLine® 7000 - Versatile Applications

Perfect for non-aqueous titrations

Eliminate the need for special electrodes (e.g. separate indicator, reference and auxiliary electrodes) with the built-in amplifier-perfect for titrations in non-aqueous solvents such as:

- Acid and base numbers in oils (TAN and TBN)
- Titrations in glacial acetic acid with perchloric acid
- Hydroxyl, NCO (Isocyanate) number and further specific value

pH-Stat Titration

With a pH stat application a given pH is first adjusted and then kept constant at the certain time with an acid or a base. The pH stat titration is applied to e.g.:

- the determination of the enzyme activity (ex. lipase)
- the pH stat elution of soil sample at pH 4
- the monitoring of the pH value during chemical syntheses

Typical Pharma application example: Titration of amino hydrochlorides (method according Ph. EUR).

Up to now the amino hydrochlorides were dissolved in glacial acetic acid, the amines released through the addition of mercuric acetate and titrated with perchloric acid in glacial acetic acid. According to the environment friendly method of the European Pharmacopeia the amino hydrochlorides are dissolved in ethanol and being dosed with exact 5.00 ml of a 0.01 mol/l HCl. This mixture is then titrated with NaOH 0.1 mol/l. Most titration curves show two equivalence points. The result is calculated from the difference between the first and second equivalence point. The method with all parameters and calculation formulae is already stored as standard method in the TitroLine® 7000 and can be used directly after the input of the equivalent substance weight.

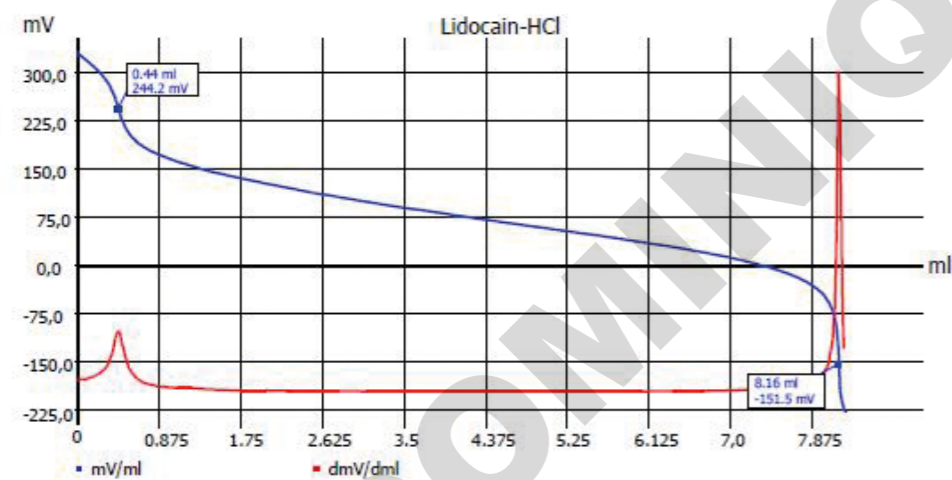

Titration curve: Titration of Hydro chloride (Lidocain-HCl)

Titration with the new photometric sensor OptiLine 6

The TitroLine® 7000 allows the connection of the new OptiLine 6 (please see also page 84) photometric sensor via USB. The TitroLine® 7000 uses the digital USB input to set the wavelength and other parameters of the photometric sensor.



TitroLine® 7800 with OptiLine 6

With the OptiLine 6, for example, the following applications are possible:

- All complexometric titrations of metals such as calcium, magnesium (total hardness), zinc, copper etc.
- All titrations with color indicator, which are prescribed in the Ph.Eur, USP, and further pharmacopeials. These titrations can now be performed automatically.
- Turbidity titration of Chondroitin sulphate according to Ph.Eur and USP
- Titration of Total acid - or Basen number (TAN and TBN) using the color indicator method.
- Determination of carboxyl end groups in polyethylene terephthalate (PET)
- For further applications examples please see page 85.

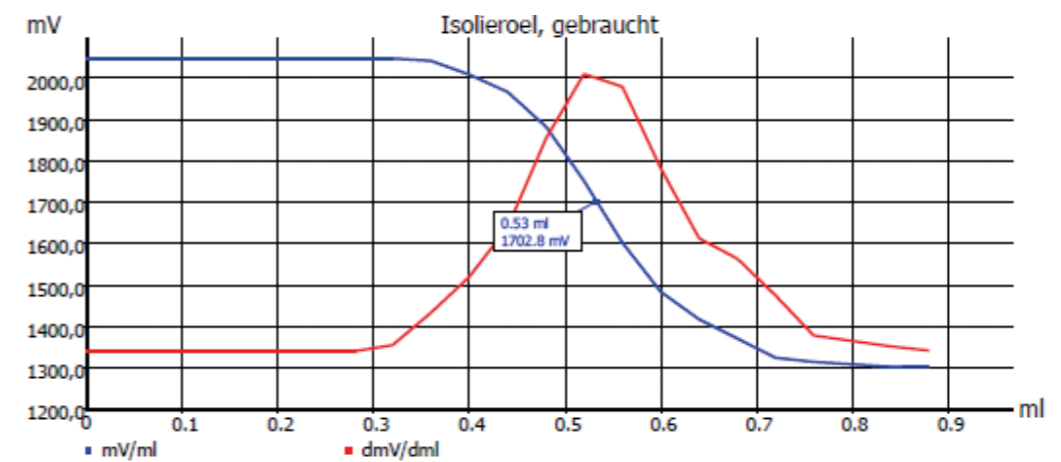

Titration curve: TAN acc. to ASTM D974

4.3 Karl Fischer Titration – the method for determining water

Experienced analyst may be unpleasantly reminded by the pyridine smell, when hearing the name Karl Fischer. However, modern reagents and most user-friendly analyzing instruments have eliminated the problem. Nowadays all applications can be handled and processed very easily by using the coulometric and volumetric Karl Fischer titration instruments. Thanks to its selectivity and precision, the Karl Fischer titration very easily and accurately established as the most important method for determining water and humidity.

The basic principle of the water determination according to Karl Fischer (short: KF) is a reaction of iodine with water in an alcoholic solution with presence of sulfuric acid and a base.

With the volumetric method the iodine can be accurately added through a piston burette or coulometric directly produced in the reaction vessel. The difference

between the volumetry and coulometry mainly exists in the manner of dosing the iodine for the titration.

The illustration shows the different types of dosing:

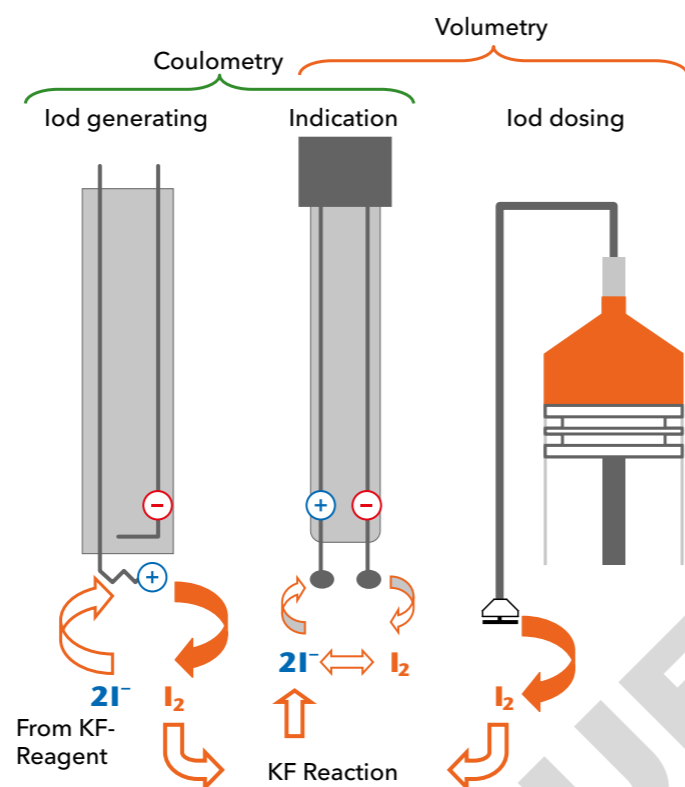

In practice small differences occur between the two methods which are displayed in the table. The advantages of the volumetry lie in the different types of sample addition and solvent variations, offering more flexible operation potentials. Where on the other hand the coulometry can handle lower detection limits and the even simpler handling. The compared work flow with coulometry and volumetry are shown with the following illustration. The clearly shorter and easier sequence is noticeable with the coulometry.

Coulometric KF titration

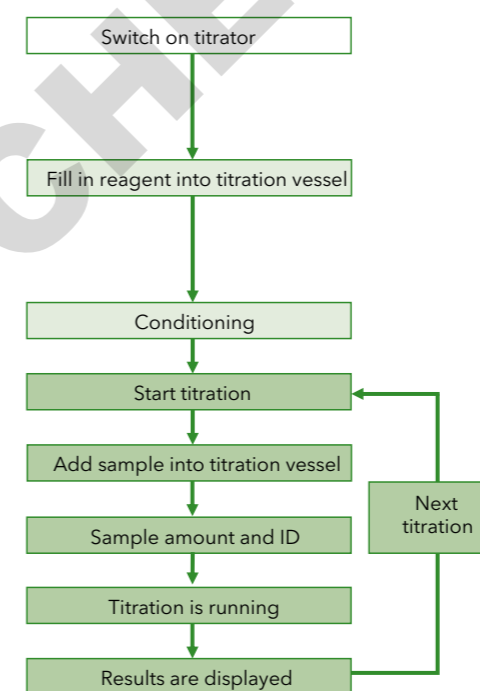

Volumetric KF titration

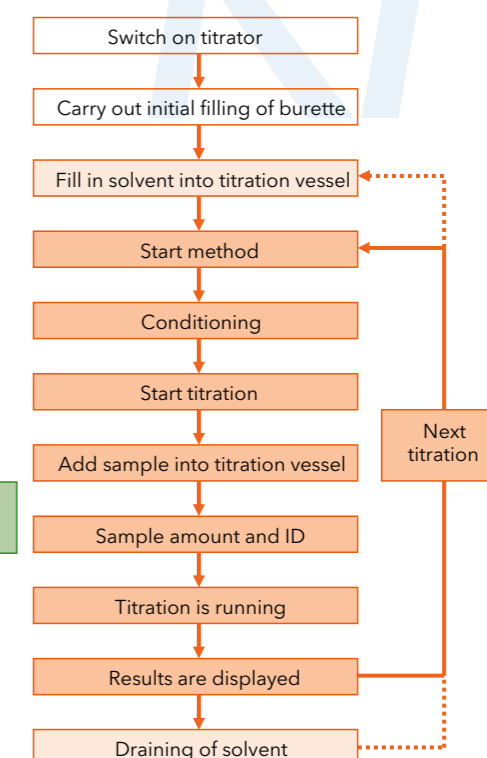

Comparison: Coulometric and volumetric Karl Fischer-titration

Property	Coulometry	Volumetry
Water amount and sample amount	Small water amount Small sample amounts	Medium and large water amounts Adapted sample amount
Sample types	Liquid Gaseous (i.e. KF oven) Solid samples with oven	Solid Liquid
Sample addition and preparation	Direct with syringe Gas inlet with oven External extraction Solid samples are evaporated with an oven	Solid samples are added directly Sample preparation with homogenisator Working at higher temperature Direct with syringe
Working method	Very fast Very simple	Fast Simple
Working range	μg range 10 μg up to 5 mg water	mg range 200 μg up to 50 mg water
Trueness	Pretty good for small water amounts > 400 μg Wasser ($\pm 0,5\%$)	Pretty good for water amounts > 5 mg water ($\pm 0,5\%$, standardization required!)
Reproducibility	Typical RSD of appr. 1% for water > 400 μg	Typical RSD of appr. 1% for water > 5 mg



TitroLine® 7500 KF



TitroLine® 7500 KF trace

4.4 TitroLine® 7500 KF and TitroLine® 7500 KF trace -

You can't go wrong with the latest TitroLine® KF titrators from SI Analytics

The TitroLine® 7500 KF is the volumetric generalist for a wide range of use and the TitroLine® 7500 KF trace is the specialist for low water contents. Both new titrators are to be characterized by following features:

- Fast, easy and precise
- With standard methods for different applications (titer, blank value, 1 or 2 component reagent)
- The addition of solvent and the extraction of the titrated sample are managed by the titration stand TM 235 KF (optional for TitroLine® 7500 KF trace)
- Online display of curve and measurement drift during titration

Benefits
TitroLine® KF (trace)



TitroLine® 7500 KF trace

Karl Fischer - Titration made easy

Live Titration curve

The online display of the measurement curve, measurement drift and titration solvent consumption (TitroLine® 7500 KF only) make accurate monitoring of the titration possible and one can determine any unwanted side reactions immediately.

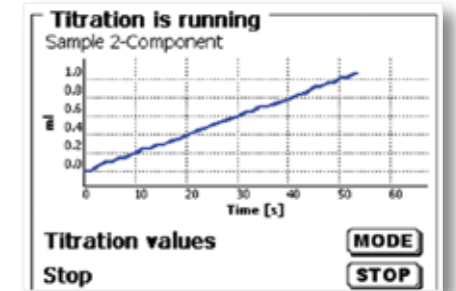

TitroLine® 7500 KF

4.5 TitroLine® 7750 - One for all

The TitroLine® 7750 is the all-rounder for both potentiometric titration and volumetric KF titration. The TitroLine® 7750 combines the features of the potentiometric titrator TitroLine® 7000 and the volumetric Karl Fischer titrator TitroLine® 7500.

The new TitroLine® 7750 is characterized as follows:



TitroLine® 7750 with accessories for potentiometric titration

- ▶ Storage of results using USB port (PDF - and CSV -format) including method transfer
- ▶ With standard methods for potentiometric and KF titration

The Titrator with more options

- ▶ Highly visible full color display, that can be easily viewed from a distance and extreme angles
- ▶ With new interchangeable modules which all relevant reagent and unit data can be stored
- ▶ Expandable thanks to the 2 x USB-host, 1 x USB-PC, 1 x LAN and 2 x RS232 ports. Connectable are e.g. USB keyboard, USB printer, barcode reader, USB flash drives, balances, PC and further SI Analytics devices such as piston burettes and sample changers
- ▶ Storage of results via USB or LAN connection, including method transfer.



TitroLine® 7750 with accessories for KF titration

→ Please refer to pages 22 and 28 (TitroLine® 7000 and TitroLine® 7500 KF) for more basic details of TitroLine® 7750.

4.6 TitroLine® 7800 - The universal titrator with IDS technology

The TitroLine® 7800 enhanced the universal features of the TitroLine® 7750 with an additional IDS measurement input. Hence the TitroLine® 7800 is able to perform potentiometric titrations with analogue or IDS electrodes up to volumetric Karl Fischer titrations. The IDS measuring input is multifunctional. Digital sensors for the determination of pH and ORP value, the conductivity up to the dissolved oxygen can be connected.

IDS stands for „intelligent, digital sensors“ and means that the analog measuring signal is converted into a digital measuring value in the sensor. This protects the signal from external interferences, such as moisture, electro-magnetic fields or pulses. The higher measuring accuracy raises confidence in your readings to a whole new level.

- ▶ Highly visible full color display, that can be easily viewed from a distance and extreme angles
- ▶ With new interchangeable modules which all relevant reagent and unit data can be stored
- ▶ Expandable thanks to the 2 x USB-host, 1 x USB-PC, 1 LAN and 2 x RS232 ports. Connectable are e.g. USB keyboard, USB printer, barcode reader, USB flash drives, balances, PC und further SI Analytics devices such as piston burettes and sample changers
- ▶ Storage of results using via USB port (PDF - and CSV -format) including method transfer
- ▶ With standard methods for potentiometric and KF titration
- ▶ Second digital measuring port for intelligent digital sensors (IDS)

Benefits
TitroLine® 7800

Titration/Burettes



TitroLine® 7800 with accessories



TitroLine® 7800 – Featuring enhanced automation and additional methods

Besides the high specification of the overall series, the TitroLine® 7750 & 7800 models provide even more functions.

Measurement and calibration with the highest accuracy

The wireless sensor recognition automatically recognizes SI Analytics ID and IDS electrodes which instantly send the specific data to the titrator. Therefore TitroLine® 7800 always uses correct calibration data. Erroneous measurements are eliminated.



Rear panel

Ideal for measurements and titration tasks with pH and Conductivity

The TitroLine® 7800 is ideally suited for use in water analysis. A typical example is the measuring of the pH and conductivity. Subsequently, as a rule the Alkalinity or Carbonate/Hydrogen carbonate hardness is determined.

Conductivity and temperature are measured immediately after the two measuring electrodes are immersed in the sample. This will take a few seconds. Then the pH value is determined by drift control. This can take more than a minute for low-ion water samples. There is no mutual influence on the pH and the LF value due to the use of the digital conductivity electrode. The acid capacity $KS_{8.2}$ and $KS_{4.3}$ are then titrated with hydrochloric acid 0.02-0.1 mol / l. The titration is carried out to a pH of 4.3 (4.5) and the consumption is determined at pH 8.2 and 4.3 (or 4.5).

End of titration 1 of 4	
Alkalinity (p+m) - Probe	
EP1	0.000 ml / pH 8.200
p-value	0.00 mmol/l
EP2	2.178 ml / pH 4.300
m-value	2.18 mmol/l
next Page	MODE
Back	ESC

End of titration 2 of 4	
Alkalinity (p+m) - Probe	
Start pH (A)	pH 7.429
Start tempe...	22.7 °C
Start cond. ...	357.2 µS/cm
Start tempe...	22.7 °C
next Page	MODE
Back	ESC

This application is very easy to automate with a sample changer. If many samples have to be measured per day, the TW 7400-42 or the TW 7400-48 are used. It is also possible to calibrate the pH electrode in the sample changer at startup.



4.7 Specifications – Piston burette TITRONIC® 500

and titrators TitroLine® 7000/7500/7750/7800

Features	TITRONIC® 500	TitroLine® 7000	TitroLine® 7500 KF	TitroLine® 7500 KF trace	TitroLine® 7750	TitroLine® 7800
Display	Color online graphic	Color online graphic	Color online graphic	Color online graphic	Color online graphic	Color online graphic
Measuring input 1 pH/mV with reference input	—	■	—	—	■	■
Measuring input 2 digital (IDS)	—	—	—	—	—	■
Wireless electrode recognition	—	■	—	—	■	■
Measuring input Dead stop (2 x 4 mm connector)	—	■	■	■	■	■
Measuring input generator electrode (2 x 4 mm connector)	—	—	—	■	—	—
Measuring input temperature (2 x 4 mm connector)	—	■	—	—	■	■
Interfaces	1 x LAN, 2 x USB-A, 1 x USB-B 2 x RS 232	1 x LAN, 2 x USB-A, 1 x USB-B 2 x RS 232	1 x LAN, 2 x USB-A, 1 x USB-B 2 x RS 232	1 x LAN, 2 x USB-A, 1 x USB-B 2 x RS 232	1 x LAN, 2 x USB-A, 1 x USB-B 2 x RS 232	1 x LAN, 2 x USB-A, 1 x USB-B 2 x RS 232
Balance connection	RS232	RS232	RS232	RS232	RS232	RS232
Printer (USB-A)	HP PCL, Seiko DPU S445, PDF	HP PCL, Seiko DPU S445, PDF	HP PCL, Seiko DPU S445, PDF	HP PCL, Seiko DPU S445, PDF	HP PCL, Seiko DPU S445, PDF	HP PCL, Seiko DPU S445, PDF
Intelligent interchangeable modules (5, 10, 20 and 50 ml)	■	■	■	—	■	■
Burette solution (steps)	20,000	20,000	20,000	—	20,000	20,000
Manual titration	■	■	—	—	■	■
Dosing applications	■	■	■	—	■	■
Solution preparation (manual or automatic when connected to balance)	■	■	■	—	■	■
Automatic Titration (Independent without external software)	1)	■	■	■	■	—
Titration to mV and pH end points	—	2 EP	—	—	2 EP	2 EP
Dynamic and linear titration to inflection points (EQ) mV and pH	—	2 EQ	—	—	2 EQ	2 EQ
Particularly suitable for non aqueous titrations	—	■	—	—	■	■
Dead-stop-titration	—	■	■	—	■	■
pH-stat-titration	—	■	—	—	■	■
Water determination according to KF volumetry (10 ppm - 100 %, recommended)	—	—	■	—	■	■
Accuracy volumetric Measurements	—	—	< 0.3% at ≥ 10mg H ₂ O	—	< 0.3% at ≥ 10mg H ₂ O	< 0.3% at ≥ 10mg H ₂ O
Water determination according to KF coulometry (1 ppm - 5 %, recommended)	—	—	—	■	—	—
Accuracy coulometric Measurements	—	—	—	< 0.3% at ≥ 10mg H ₂ O	—	—
Standard methods	■	■	■	■	■	■
Number of user methods	15	50	50	50	50	50
Connection and control of autosamplers	—	■	—	—	■	■
Controlable via TitrSoft 3.3 and higher	■	■	■	■	■	■

1) Can be used as titration and dosing burette in automatic titration systems

Specifications – Piston burette TITRONIC® 500

and TitroLine® 7000/7500/7500/7750/7800

Features	TITRONIC® 500	TitroLine® 7000	TitroLine® 7500 KF	TitroLine® 7500 KF trace	TitroLine® 7750	TitroLine® 7800
Analogue measuring inputs						
Measuring input 1 (analog) pH/mV with reference electrode input	—	pH/mV-input with 24 bit transducer Electrode socket according to DIN 19 262 or additional with BNC socket insert RFID receiver for SI Analytics ID electrodes	—	—	pH/mV-input with 24 bit transducer Electrode socket according to DIN 19 262 or additional with BNC socket insert RFID receiver for SI Analytics ID electrodes	pH/mV-input with 24 bit transducer Electrode socket according to DIN 19 262 or additional with BNC socket insert RFID receiver for SI Analytics ID electrodes
Measuring range pH	—	-3.0 to 18.00	—	—	-3.0 to 18.00	-3.0 to 18.00
Display resolution pH / Accuracy pH (without sensor probe)	—	0.001 / 0.002 ± 1 Digit	—	—	0.001 / 0.002 ± 1 Digit	0.001 / 0.002 ± 1 Digit
Measuring range mV	—	-2000 to 2000	—	—	-2000 to 2000	-2000 to 2000
Display resolution mV / Accuracy mV (without sensor probe)	—	0.1 / 0.1 ± 1 Digit	—	—	0.1 / 0.1 ± 1 Digit	0.1 / 0.1 ± 1 Digit
Analogue measuring inputs - Dead Stop						
Measuring input Dead stop (2 x 4 mm socket)	—	Connector (µA) for double platinum electrodes Polarisation voltage adjustable from 40 to 220 mV	Connector (µA) for double platinum electrodes Polarisation voltage adjustable from 40 to 220 mV	Connector (µA) for double platinum electrodes	Connector (µA) for double platinum electrodes Polarisation voltage adjustable from 40 to 220 mV	Connector (µA) for double platinum electrodes Polarization voltage adjustable from 40 to 220 mV
Display resolution µA / Accuracy µA (without sensor probe)	—	0.1 / 0.2 ± 1 Digit	0.1 / 0.2 ± 1 Digit	—	0.1 / 0.2 ± 1 Digit	0.1 / 0.2 ± 1 Digit
Measuring input temperature (2 x 4 mm socket)	—	Connector for Pt 1000 / NTC 30kΩ	—	—	Connector for Pt 1000 / NTC 30kΩ	Connector for Pt 1000 / NTC 30kΩ
Measuring range temperature °C	—	Pt 1000: -75 to 195 / NTC 30kΩ -40...125°C	—	—	Pt 1000: -75 to 195 / NTC 30kΩ -40...125°C	Pt 1000: -75 to 195 / NTC 30kΩ -40...125°C
Display resolution °C / Accuracy °C (without sensor probe)	—	0.1 / Pt 1000: 0.2 K ± 1 Digit NTC 30kΩ: 1.0 K (-40...0°C)/0.3 K (0...125 °C) ± 1 Digit	—	—	0.1 / Pt 1000: 0.2 K ± 1 Digit NTC 30kΩ: 1.0 K (-40...0°C)/0.3 K (0...125 °C) ± 1 Digit	0.1 / Pt 1000: 0.2 K ± 1 Digit NTC 30kΩ: 1.0 K (-40...0°C)/0.3 K (0...125 °C) ± 1 Digit
Digital measuring inputs						
Measuring input 2 (IDS)	—	—	—	—	—	Accuracy ± 1 Digit depending on the used IDS electrode
Messbereich pH	—	—	—	—	—	0.000 to 14.000 ± 0.004 pH
Messbereich mV	—	—	—	—	—	± 1200.0 mV ± 0.2 mV
Messbereich Temperatur °C	—	—	—	—	—	-5.0 ... 105.0 °C ± 0.2 mV
Messbereich Leitfähigkeit	—	—	—	—	—	0.00 ... 2000 mS/cm ± 0.5% v. Mw.
Display	3.5 inches -1/4 VGA TFT display with 320 x 240 pixels	3.5 inches -1/4 VGA TFT display with 320 x 240 pixels	3.5 inches -1/4 VGA TFT display with 320 x 240 pixels	3.5 inches -1/4 VGA TFT display with 320 x 240 pixels	3.5 inches -1/4 VGA TFT display with 320 x 240 pixels	3.5 inches -1/4 VGA TFT display with 320x240 pixels
Housing material	Polypropylene	Polypropylene	Polypropylene	Polypropylene	Polypropylene	Polypropylene
Front keyboard	Polyester coated	Polyester coated	Polyester coated	Polyester coated	Polyester coated	Polyester coated
Housing dimensions	15.3 x 45 x 29.6 cm (W x H x D), height with interchangeable unit	15.3 x 45 x 29.6 cm (W x H x D), height with interchangeable unit	15.3 x 45 x 29.6 cm (W x H x D), height with interchangeable unit	15,3 x XX x 29,6 cm (W x H x D)	15.3 x 45 x 29.6 cm (W x H x D), height with interchangeable unit	15.3 x 45 x 29.6 cm (W x H x D), height with interchangeable unit
Weight	2.2 kg for basic unit 3.5 kg for complete device incl. interchangeable unit (with empty reagent bottle, without magnetic stirrer)	2.3 kg for basic unit 3.5 kg for complete device incl. interchangeable unit (with empty reagent bottle, without magnetic stirrer)	2.3 kg for basic unit 3.5 kg for complete device incl. interchangeable unit (with empty reagent bottle, without magnetic stirrer or TM 235 KF)	2.3 kg for basic unit without magnetic stirrer TM 235 or TM 235 KF	2.3 kg for basic unit 3.5 kg for complete device incl. interchangeable unit (with empty reagent bottle, without magnetic stirrer or TM 235 KF)	2.3 kg for basic unit 3.5 kg for complete device incl. interchangeable unit (with empty reagent bottle, without magnetic stirrer)
Ambient conditions	Ambient temperature: +10 to +40 °C for operation and storage	Ambient temperature: +10 to +40 °C for operation and storage	Ambient temperature: +10 to +40 °C for operation and storage	Ambient temperature: +10 to +40 °C for operation and storage	Ambient temperature: +10 to +40 °C for operation and storage	Ambient temperature: +10 to +40 °C for operation and storage
Material: intelligent interchangeable units (5, 10, 20 and 50 ml)	Valve: PTFE/ETFE Cylinder: borosilicate glass 3.3 (DURAN®) Hoses: FEP, blue	Valve: PTFE/ETFE Cylinder: borosilicate glass 3.3 (DURAN®) Hoses: FEP, blue	Valve: PTFE/ETFE Cylinder: borosilicate glass 3.3 (DURAN®) Hoses: FEP, blue	—	Valve: PTFE/ETFE Cylinder: borosilicate glass 3.3 (DURAN®) Hoses: FEP, blue	Valve: PTFE/ETFE Cylinder: borosilicate glass 3.3 (DURAN®) Hoses: FEP, blue
Dosing accuracy according DIN EN ISO 8655, part 3	Accuracy : 0.15 % Precision: 0.05 - 0.07 % (Depending on the used interchangeable unit)	Accuracy : 0.15 % Precision: 0.05 - 0.07 % (Depending on the used interchangeable unit)	Accuracy : 0.15 % Precision: 0.05 - 0.07 % (Depending on the used interchangeable unit)	—	Accuracy : 0.15 % Precision: 0.05 - 0.07 % (Depending on the used interchangeable unit)	Accuracy : 0.15 % Precision: 0.05 - 0.07 % (Depending on the used interchangeable unit)

Titrators/Burettes

4.8 Ordering information: TITRONIC® 500, TitroLine® 7000/7500/7750/7800

Type No.	Order No.	Description
T 500	285220200	TITRONIC® 500 basic unit without magnetic stirrer, with stand rod and titration clamp Z 305, controller TZ 3880, power supply 100-240 V
T 500-M1	285220210	TITRONIC® 500 basic unit with magnetic stirrer TM 235, with stand rod TZ 1510, electrode clamp Z 305, hand controller TZ 3880, power supply 100-240 V
T 500-M2/20	285220220	TITRONIC® 500 basic unit with magnetic stirrer TM 235 and 20 ml exchange unit WA 20, with stand rod TZ 1510, electrode clamp Z 305, hand controller TZ 3880, power supply 100-240 V
TL 7000	285220100	TitroLine® 7000 basic unit without magnetic stirrer, with stand rod and titration clamp Z 305, power supply 100-240 V
TL 7000-M1/10	285220140	TitroLine® 7000 basic unit with magnetic stirrer TM 235 and 10 ml exchangeable unit WA 10, with brown glass bottle for titrant, GL 45 and S 40-bottle adapter, tubes, drip tube and titration tip
TL 7000-M1/20	285220150	TitroLine® 7000 basic unit with magnetic stirrer TM 235 and 20 ml exchangeable unit WA 20, with brown glass bottle for titrant, GL 45 and S 40-bottle adapter, tubes, drip tube and titration tip
TL 7000-M1/50	285220160	TitroLine® 7000 basic unit with magnetic stirrer TM 235 and 50 ml exchangeable unit WA 50, with brown glass bottle for titrant, GL 45 and S 40-bottle adapter, tubes, drip tube and titration tip
TL 7000-M2/20	285220170	TitroLine® 7000 basic unit with magnetic stirrer TM 235 and 20 ml exchangeable unit WA 20, with brown glass bottle for titrant, GL 45 and S 40-bottle adapter, tubes, drip tube and titration tip. With pH-combination electrode and buffer set.
TL 7000-TitriSoft	285220960	basic unit with magnetic stirrer TM 235, with stand rod and titration clamp Z 305, power supply 100-240 V, software TitriSoft 3.3 (TZ 3071)
TL 7500 KF 05	285220810	Volumetric KF-Titrator, scope of supply: basic titrator unit, exchange unit WA 05, TM 235 KF titration stand with integrated stirrer and pump, titration vessel TZ 1770, micro double platinum electrode KF 1100 and starter kit, power supply 100-240 V
TL 7500 KF 10	285220820	Volumetric KF-Titrator, scope of supply: basic titrator unit, exchange unit WA 10, TM 235 KF titration stand with integrated stirrer and pump, titration vessel TZ 1770, micro double platinum electrode KF 1100 and starter kit, power supply 100-240 V
TL 7500 KF 20	285220830	volumetric KF-Titrator, scope of supply: basic titrator unit, exchange unit WA 20, TM 235 KF titration stand with integrated stirrer and pump, titration vessel TZ 1770, micro double platinum electrode KF 1100 and starter kit, power supply 100-240 V
TL 7500 KF trace M1	285220860	Module 1, coulometric KF-Titrator, scope of supply: basic titrator unit, generator electrode TZ 1752 without junction + connection cable, magnetic stirrer TM 235, stand rod, titration vessel TZ 1751, micro double platinum electrode KF 1150
TL 7500 KF trace M2	285220870	Module 2, coulometric KF-Titrator, scope of supply: basic titrator unit, generator electrode TZ 1752 without junction + connection cable, TM 235 KF titration stand with integrated stirrer and pump, stand rod, titration vessel TZ 1754, micro double platinum electrode KF 1150
TL 7500 KF trace M3	285220880	Module 3, coulometric KF-Titrator, scope of supply: basic titrator unit, generator electrode TZ 1753 with junction + connection cable, magnetic stirrer TM 235, stand rod, titration vessel TZ 1751, micro double platinum electrode KF 1150
TL 7500 KF trace M4	285220890	Module 4, coulometric KF-Titrator, scope of supply: basic titrator unit, generator electrode TZ 1753 with junction + connection cable, TM 235 KF titration stand with integrated stirrer and pump, stand rod, titration vessel TZ 1754, micro double platinum electrode KF 1150
TL 7500 KF trace M5	285221000	Module 5, coulometric KF-Titrator, scope of supply: basic titrator unit, generator electrode TZ 1752 without junction + connection cable, magnetic stirrer TM 235, stand rod, titration vessel TZ 1754, micro double platinum electrode KF 1150
TL 7750	285220240	Basic unit without magnetic stirrer, with stand rod; TZ 1510, electrode clamp Z 305, hand controller TZ 3880, power supply 100-240 V
TL 7750-M1	285220250	Basic unit with magnetic stirrer TM 2325, with stand rod; TZ 1510, electrode clamp Z 305, hand controller TZ 3880, power supply 100-240 V
TL 7750 KF 05	285220930	TitroLine® 7750 with KF accessories, scope of supply: basic titrator unit, exchange unit WA 05, TM 235 KF titration stand with integrated stirrer and pump, titration vessel TZ 1770, micro double platinum electrode KF 1100 and starter kit, power supply 100-240 V
TL 7750 KF 10	285220940	TitroLine® 7750 with KF accessories, scope of supply: basic titrator unit, exchange unit WA 10, TM 235 KF titration stand with integrated stirrer and pump, titration vessel TZ 1770, micro double platinum electrode KF 1100 and starter kit, power supply 100-240 V
TL 7750 KF 20	285220950	TitroLine® 7750 with KF accessories, scope of supply: basic titrator unit, exchange unit WA 20, TM 235 KF titration stand with integrated stirrer and pump, titration vessel TZ 1770, micro double platinum electrode KF 1100 and starter kit, power supply 100-240 V
TL 7750-TitriSoft	285220970	basic unit with magnetic stirrer TM 235, with stand rod and titration clamp Z 305, power supply 100-240 V, software TitriSoft 3.3 (TZ 3071)
TL 7800	285220980	TitroLine® 7800 basic unit with two measuring inputs, one analogue and one digital (IDS) measuring input
TL 7800-M1	285220990	TitroLine® 7800 basic unit with two measuring inputs, one analogue and one digital (IDS) measuring input, with magnetic stirrer TM 235
TL 7800-TitriSoft	285221030	basic unit with two measuring inputs, one analogue and one ein digital (IDS) measuring input, with magnetic stirrer TM 235 and TitriSoft 3.2

Accessories for TITRONIC® 500, TitroLine® 7000/7500/7750/7800

Type No.	Order No.	Description
WA 05	285220300	5 ml exchangeable unit with integrated chip for reagent data, with brown glass bottle for titrant, GL 45 and S 40-bottle adapter, tubes, drip tube and titration tip
WA 10	285220310	10 ml exchangeable unit with integrated chip for reagent data, with brown glass bottle for titrant, GL 45 and S 40-bottle adapter, tubes, drip tube and titration tip
WA 20	285220320	20 ml exchangeable unit with integrated chip for reagent data, with brown glass bottle for titrant, GL 45 and S 40-bottle adapter, tubes, drip tube and titration tip
WA 50	285220350	50 ml exchangeable unit with integrated chip for reagent data, with brown glass bottle for titrant, GL 45 and S 40-bottle adapter, tubes, drip tube and titration tip
TM 235, 115-230 V	285220400	Magnetic stirrer for vessels up to 500 ml, agitator speed infinitely adjustable from 500 - 2000 r/min, for the connection to TitroLine® 6000/7000 and TITRONIC® 500
TM 235 KF, 115-230 V	285220900	Titration stand with pump; Scope of delivery: Basic unit with 1 l DURAN®-reagent bottle TZ 1791, 1 l DURAN®-waste bottle TZ 1792, moisture bottle, tubes and screw threads, power supply TZ 1855 (110 to 240 V)
TZ 1052	285214721	KF-drying stove, 230 V
TZ 1055	285215183	KF-drying stove, 115 V
TZ 1060	285218115	Accessories set for KF drying stove TZ 1052/TZ1055
TZ 1065	285201973	Flowmeter with valve and hose connectors for gas volumes (air, nitrogen) from 50 - 500 ml/min.
KF 1100	285102030	Micro double platinum electrode for Karl Fischer titrations, with fixed cable, double platinum pin and taper NS 7.5 for TZ 1770 and TZ 1772
TZ 1748	285216560	Stand rod stainless steel Ø 10 mm
TZ 1770	285216677	Karl Fischer titration vessel. DURAN® glass vessel TZ 1775 (approx. 30...150 ml), removable head made of polypropylene/PTFE, 1 drilling NS 19, NS 14,5, NS 7,5 and 3 drillings with screw threads, titration tip, moisture trap and weighing funnel
TZ 1789	285221120	Starter kit KF consisting of molecular sieve, needles with syringes and glass wool
TZ 3863	285220480	USB-thermo printer, 112 mm for TitroLine® 6000/7000/7500 KF/7500 KF trace/7750 and TITRONIC® 500
TZ 3864	285220710	Thermal paper for TZ 3863 with very high durability (5 rolls)
TZ 3865	285220440	DIN A4 standard printer, HP PCL-compatible, with USB-connection cable, 230 V

5.1 TW alpha plus and TW 7400

sample changer – automatic titration in series

The number of samples to be processed is growing constantly while at the same time the demands on reliability are increasing in accordance with GLP and ISO 900X standards. The TW *alpha plus* and the TW 7400 sample changers by SI Analytics helps you meet these increased requirements and relieve qualified employees from routine work.

Control by titrator or by PC

You can control the sample changer from the TitroLine® 7000/7750/7800 titrator or from a PC with the TitriSoft software.

Higher flexibility due to exchangeable sample racks

With four sample racks for up to 72 samples (TW 7400) and titration head fittings for a variety of beaker and titrator vessels you get the flexibility your lab needs. The sample racks and titrator heads are very quick and simple to change. The size of the rack can be selected in the TitroLine® 7000/7750/7800 or in the ›Titration Center‹ of the TitriSoft software.

Stirring from “above” or “below”

As standard, the TW *alpha plus* comes with an integrated magnetic stirrer to stir the samples from “below”. Alternatively, you can use a rod stirrer which enables stirring from “above”. TW 7400 always stirs from “above”.



TW alpha plus with 16 sample dish and pump MP 25

TW alpha plus with sample dish for COD vessels after DIN

Washing the electrode and the titration tip

To ensure accuracy of the results, the electrodes and the titration tips are rinsed after each titration. This can, for example, be done by immersing the electrodes and titration tips into a washing solution. The number of rinsing positions to be used (up to a maximum of three) and the rinsing time are set in the method. Direct and fast rinsing of the electrodes and titration tips can be ensured by using the MP 25 washing unit that rinses directly after the titration. In addition to this, a waiting position may also be used for example to immerse the pH electrodes into a KCl solution.

Automatic COD Titration

For the direct titration of the COD there is a special sample tray for TW *alpha plus* with 24 positions available.

Sample Changer

5.2 For large sample throughput - TW 7400 sample changer

The new X/Y sample changer TW7400 has been developed for high sample throughput. There are three different sample rack sizes of 42, 48 and 72 positions, and three different titration heads available.

Both the sample racks and the titration heads are easily exchanged. The sample rack with the 42 positions can be operated with beakers of either 150 or 250ml volume. These are used in particular in the water and environmental analysis. With this sample rack the use of the irrigation pump MP 25 is recommend. The sample rack with 72 positions can be operated with beakers of 50ml and special sample containers for a sample volume up to approximately 75ml. Typical applications include e.g. the wine and beverage analysis, pH measurements in soil samples or the determination of the alkalinity in Seawater.

The sample with 48 positions is suitable for 100ml beakers especially used for wine analysis.

Selection table autosampler TW *alpha plus* and TW7400

Feature/Accessory	TW <i>alpha plus</i>	TW 7400
Stirring from the bottom with built-in magnetic stirrer	■	—
Rod stirrer TZ 1847 Suitable for all sample racks besides COD	■	■
Rod stirrer TZ 1846 Suitable only for COD sample rack	■	—
Rinsing pump MP 25. Suitable for sample racks: TZ 1452, TZ 1459 und TZ 3942	■	■
Sample rack for 12 positions TZ 1452 Suitable for titration vessel 250 ml low form (scope of supply) and 400 ml tall form	■	—
Sample rack for 12 positions TZ 1453 Suitable for titration vessel 600 ml tall form TZ 1766	■	—
Sample rack for 16 positions TZ 1457 Suitable for titration vessel 100 ml tall form (scope of supply)	■	—
Sample rack for 16 positions TZ 1459 Suitable for titration vessel 150 ml low form (scope of supply) and 250 ml tall form	■	—
Sample rack for 16 positions TZ 1458 Suitable for 100 ml laboratory bottles TZ 1494	■	—
Sample rack for 24 positions TZ 1454 Suitable for titration vessel 50 ml tall form (scope of supply) and titration vessel up to 75 ml sample volume (TZ 1786) and titration vessel TZ 3973 (PP)	■	—
Sample rack for 24 positions TZ 1444 Suitable for COD sample vessel 100 ml according to DIN (not included in scope of supply!)	■	—
Titration head TZ 1463 with 7 openings NS 14 Suitable for sample rack TZ 1459 and TZ 1452	■	—
Titration head TZ 1464 with 4 openings NS 14, splash Suitable for sample rack TZ 1457 and TZ 1459	■	—
Titration head TZ 1467 with 7 openings NS 14, splash shield and rinsing spray Suitable for sample rack TZ 1459 and TZ 1452 in combination with rinsing pump MP 25	■	—
Micro-titration head TZ 1469 with 4 openings Suitable for sample rack TZ 1454	■	—
COD titration head TZ 1461 with 3 openings Suitable for COD sample rack TZ 1444.	■	—
Sample rack for 42 position TZ 3942 Suitable for titration vessel 150 ml low form (scope of supply) and 250 ml tall form	—	■
Sample rack for 48 positions TZ 3948 Suitable for titration vessel 100 ml tall form (scope of supply)	—	■
Sample rack for 72 positions TZ 3972 Suitable for titration vessel 50 ml tall form (scope of supply) and titration vessel for up to 75 ml sample volume (TZ 1786)	—	■
Titriertopf TZ 3963 with 7 openings NS 14 Suitable for sample rack TZ 3942	—	■
Titration head TZ 3967 with 7 openings NS 14, splash shield and rinsing spray Suitable for sample rack TZ 3942 in combination with rinsing pump MP 25	—	■
Micro-titration head TZ 3969 with 4 openings Suitable for sample rack TZ 3948 and TZ 3972	—	■

Important note: The rinsing pump MP 25 can only be used in combination with the titration heads TZ 1467, TZ 3967 and the sample rack TZ 1452, TZ 1459 and TZ 3942.

TW 7400 with 42 position sample rack



TW 7400 with 48 position sample rack



TW 7400 with 72 position sample rack



5.3 Ordering information: Sample changer TW *alpha* plus and TW7400

Type No.	Order No.	Description
TW alpha plus, 230 V	1007290	Basic unit with integrated magnetic stirrer, incl. mains cable and connection cable for rod stirrer TZ 1581, 230 V
TW alpha plus, 115 V	1007291	Basic unit with integrated magnetic stirrer, incl. mains cable and connection cable for rod stirrer TZ 1581, 115 V
TW alpha plus 12, 230 V	1007292	Basic unit TW alpha plus with sample rack TZ 1452 for 12 samples, incl. titration head TZ 1463, mains cable, connection cable TZ 3084 and 20 beakers, 250 ml, low form, 230 V
TW alpha plus 12, 115 V	1007293	Basic unit TW alpha plus with sample rack TZ 1452 for 12 samples, incl. titration head TZ 1463, mains cable, connection cable TZ 3084 and 20 beakers, 250 ml, low form, 115 V
TW alpha plus 16, 230 V	1007294	Basic unit TW alpha plus with sample rack TZ 1459 for 16 samples, incl. titration head TZ 1463, mains cable, connection cable TZ 3084 and 20 beakers, 150 ml, low form, 230 V
TW alpha plus 16, 115 V	1007295	Basic unit TW alpha plus with sample rack TZ 1459 for 16 samples, incl. titration head TZ 1463, mains cable, connection cable TZ 3084 and 20 beakers, 150 ml, low form, 115 V
TW alpha plus 16-100, 230 V	285225870	Basic unit TW alpha plus with sample rack TZ 1457 for 16 samples, incl. titration head TZ 1464, mains cable and 20 beakers, 100 ml, tall form, 230 V
TW alpha plus 16-100, 115 V	285225880	Basic unit TW alpha plus with sample rack TZ 1457 for 16 samples, incl. titration head TZ 1464, mains cable and 20 beakers, 100 ml, tall form, 115 V
TW alpha plus 24, 230 V	1007296	Basic unit TW alpha plus with sample rack TZ 1454 for 24 samples, incl. titration head TZ 1469, mains cable, connection cable TZ 3084 and 30 beakers, 50 ml, high form, 230 V
TW alpha plus 24, 115 V	1007297	Basic unit TW alpha plus with sample rack TZ 1454 for 24 samples, incl. titration head TZ 1469, mains cable, connection cable TZ 3084 and 30 beakers, 50 ml, high form, 115 V
TW alpha plus MP, 230 V	1007305	Basic unit TW alpha plus with sample rack TZ 1459 for 16 samples, incl. titration head TZ 1467, washing unit MP 25, mains cable, connection cable TZ 3084 and 20 beakers, 150 ml, low form, 230 V
TW alpha plus MP, 115 V	1007306	Basic unit TW alpha plus with sample rack TZ 1459 for 16 samples, incl. titration head TZ 1467, washing unit MP 25, mains cable, connection cable TZ 3084 and 20 beakers, 150 ml, low form, 115 V
TW alpha plus CSB, 230 V	1007298	Basic unit TW alpha plus with sample rack TZ 1444 for COD-24 samples according to DIN 38 409, incl. titration head TZ 1461, redox electrode Pt 5901, rod stirrer TZ 1846, titration tip TZ 1648, mains cable and connection cable TZ 3084, 230 V
TW alpha plus CSB, 115 V	1007299	Basic unit TW alpha plus with sample rack TZ 1444 for COD-24 samples according to DIN 38 409, incl. titration head TZ 1461, redox electrode Pt 5901, rod stirrer TZ 1846, titration tip TZ 1648, mains cable and connection cable TZ 3084, 115 V
TW 7400	1007400	Basic unit without titration head and sample rack. With connection cable TZ 3987 for the connection on titrator TitroLine® 7XXX, power supply 100-240 V
TW 7400-42	285226600	Basic unit with sample rack TZ 3942 for 42 samples, titration head TZ 3963, rod stirrer TZ 1847 and FEP-hose (5 m), 100-240 V
TW 7400-48	285226620	Basic unit with sample rack TZ 3948 for 48 samples, titration head TZ 3964, rod stirrer TZ 1847 and FEP-hose (5 m), 100-240 V
TW 7400-72	285226630	Basic unit with sample rack TZ 3972 for 72 samples, titration head TZ 3969, rod stirrer TZ 1847 and FEP-hose (5 m), 100-240 V
TW 7400-42 MP	285226610	Basic unit with sample rack TZ 3942 for 72 samples, titration head TZ 3967, rod stirrer TZ 1847, washing unit MP 25 and FEP-hose (5 m), 100-240 V

Accessories for sample changer TW *alpha* plus and TW 7400

Type No.	Order No.	Description
TZ 1444	285213836	Sample tray for TW alpha plus for 24 COD vessels according to DIN 38 409
TZ 1452	285214927	Sample tray for TW alpha plus for 12 sample vessels, incl. 20 beakers, 250 ml, low form
TZ 1453	285213853	Sample tray TW alpha plus for 12 sample vessels, incl. 20 beakers, 600 ml, tall form
TZ 1454	285213844	Sample tray for TW alpha plus for 24 sample vessels, incl. 30 beakers, 50 ml, tall form
TZ 1457	285213869	Sample tray for TW alpha plus for 16 sample vessels, incl. 20 beakers, 100 ml, tall form
TZ 1458	285213918	Sample tray for TW alpha plus for 16 sample vessels, incl. 20 laboratory bottles, 100 ml
TZ 1459	285213166	Sample tray for TW alpha plus for 16 sample vessels, incl. 20 beakers, 150 ml, low form
TZ 1463	285213647	Titration head for TW alpha plus for 12 (TZ 1452) and 16 sample rack TZ 1459 with 7 drillings NS 14.5
TZ 1464	285213654	Titration head for sample tray TZ 1457 (16 positions) with 4 apertures different sizes
TZ 1467	285213671	Titration head for TW alpha plus for 12 (TZ 1452) and 16 sample rack TZ 1459 with 7 drillings NS 14.5 incl. splash shield and rinsing spray
TZ 1469	285213884	Titration head for TW alpha plus for 24 pos. sample rack TZ 1454 with 4 openings (2 x NS 14,5 and 2 x NS 7,5) and 1 adapter for micro electrodes with 6 mm diameter.
TZ 3942	285217790	Sample rack for TW 7400 with 42 positions for 150 ml beakers low form or 250 ml beakers tall form
TZ 3948	285217800	Sample rack for TW 7400 with 48 positions for 100 ml beakers low form
TZ 3972	285217810	Sample rack for TW 7400 with 72 positions for 50 ml beakers tall form
TZ 1844	285213199	Rod stirrer mid size model (120 mm) with NS 14.5
TZ 1846	285215134	Rod stirrer long version (200 mm) with NS 14.5 for COD reaction vessels according to DIN 38 409 section 41 for sample changer TW alpha plus
TZ 1847	285215175	Rod stirrer, short version with NS 14,5 for titration head TZ 1463, TZ 1467, TZ 1469, TZ 3942, TZ 3948 and TZ 3972
TZ 1545	285214232	Magnetic stirrer bar, 30 mm, 30 mm, 10 pcs. for TW alpha plus
MP 25	285216005	Membrane pump MP 25 with accessories (5 L - storage bottle, connection tubes, rinsing nozzle, connection cable) for TW alpha/TW alpha plus, 100-240 V

Data cables

Type No.	Order No.	Description
TZ 3840	285220690	USB connection cable, Type A (M) --- USB Type B (M), 1,8 m
TZ 3081	1007979	TW alpha plus <-> Mettler AB-S, PG balances, 5 m
TZ 3082	1007977	TW alpha plus <-> Sartorius balances, 5 m
TZ 3087	1007976	TitroLine® 7000, TitroLine® 7750, TitroLine® 7800, TITRONIC® 500 or TITRONIC® 300 <-> TW alpha plus, 1,5 m
TZ 3091	285223504	TITRONIC® 300, TITRONIC® 500 TitroLine® 5000, TitroLine® 6000, 7000, 7750, 7800, 7500 KF, 7500 KF trace <-> PC, 5 m
TZ 3092	285223529	TitroLine® 6000,7000, 7750, 7800, 7500 KF, 7500 KF trace <-> Sartorius balances
TZ 3094	285223545	TITRONIC® 300 <-> TITRONIC® 300, TITRONIC® 500 <-> TITRONIC® 500, TitroLine® 7000 <-> TitroLine® 7000 etc.
TZ 3097	285223578	TITRONIC® 300, TITRONIC® 500 TitroLine® 5000, TitroLine® 6000, 7000, 7750, 7800 7500 KF, 7500 KF trace <-> PC, 1,5 m
TZ 3099	285223594	TitroLine® 6000,7000, 7750, 7800, 7500 KF, 7500 KF trace <-> Mettler AB-S, PG - balances, 1,5 m
TZ 3193	285223600	TITRONIC® 300, TITRONIC® 500 TitroLine® 5000, TitroLine® 6000, 7000, 7750, 7800, 7500 KF, 7500 KF trace <-> PC, 15 m
TZ 3891	285223465	TITRONIC® 300, TITRONIC® 500 TitroLine® 5000, TitroLine® 6000, 7000, 7750, 7800, 7500 KF, 7500 KF trace <-> PC, 5 m
TZ 3987	285217860	TitroLine® 7000, TitroLine® 7750, 7800, 7500 KF, 7500 KF trace, TITRONIC® 500 or TITRONIC® 300 <-> TW 7400, 1,5 m

6.1 TitriSoft 3.3 – convincingly simple with strong benefits

The TitriSoft 3.3 titration software is the optimum solution for your titration tasks. The software can be used with Windows 7, 8.1 and 10 and supports your daily work procedures during sample preparation, titration and evaluation of the results. The software has been developed to be clear, logical and user-friendly.

Connection possibilities

Using TitriSoft 3.3 you can control the following devices from a PC:

- Titrators TitroLine® (7000, 7750, 7500 KF, 7500 KF trace and alpha plus)
- Sample changers (TW alpha plus, TW 7400, TW alpha und TW 280)
- Piston burettes TITRONIC® (300, 500 and universal, 110/200 and 110 plus)
- Balances

You can connect the titration hardware to any of your PC's available USB-A or serial interfaces. Each of the interfaces allows different combinations of devices (configurations). To automate a titration procedure the software may be used to control, for example, a TitroLine® 7800 in connection with the TW alpha plus sample changer. For more complex titration tasks with sample preparation you can dose with piston burettes followed by titration with a TitroLine® 7000, 7750 or 7800. Of course, you can also use the software for dosing with piston burettes only.

The image below shows possible device configurations.

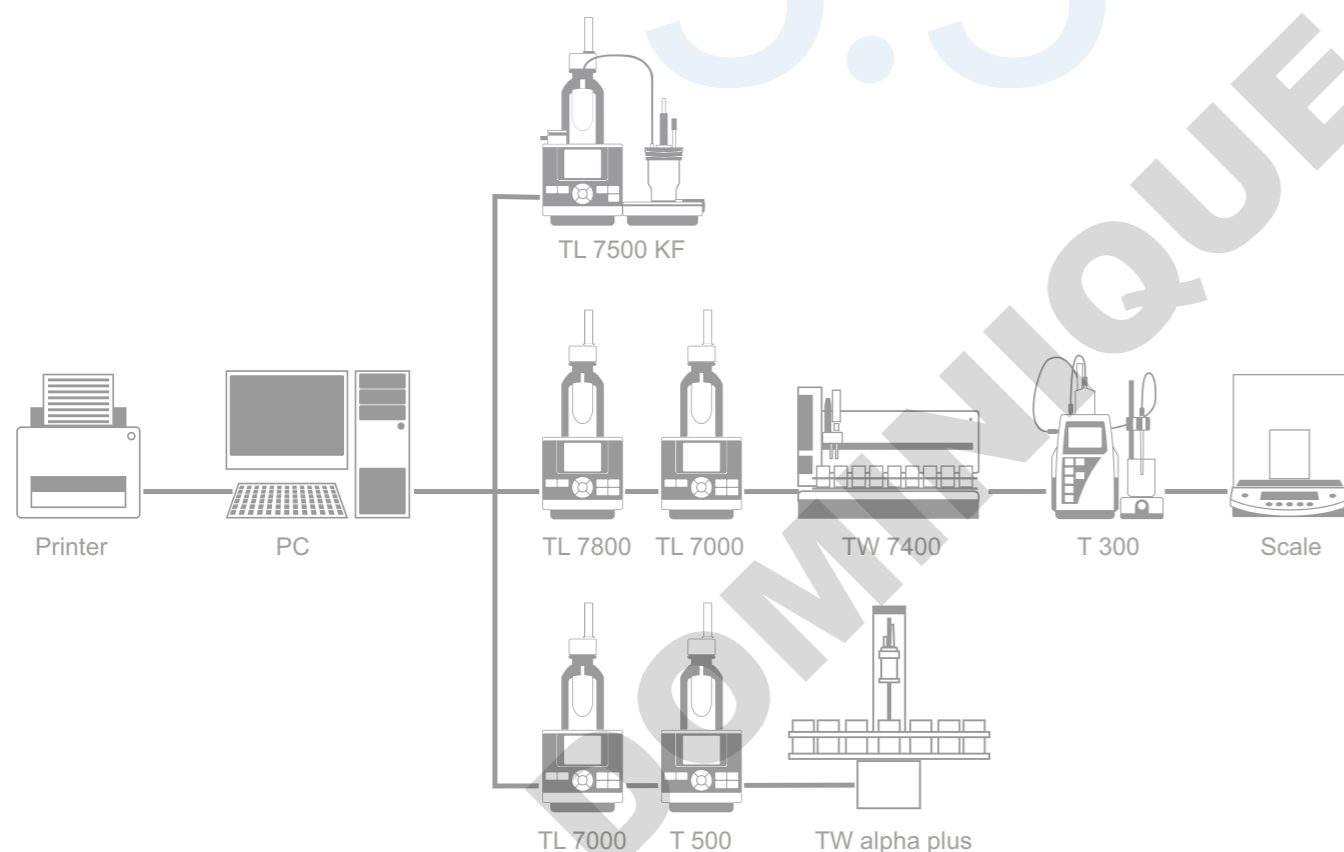

System requirements

For optimal and fast working with the TitriSoft 3.3 software your system should be equipped as shown below:

Interface: a free USB or RS232-interface per configuration

Computer: Pentium (Dual-Core) 2 GHz or higher (I3 or higher recommended)

Operating system: Windows 7, 8.1 or 10 (32/64 bit)

RAM: minimum 2 GB (4 GB or more recommended)

Hard disk: minimum free storage volume 200 MB

Graphics card: minimum resolution 1280 x 1024 recommended 1920 x 1200

›Titration Center, the main menu

The different software tasks are assigned to five different centers:

- Settings
- Database
- Analysis
- Worklists
- Curve

Each of these centers can be chosen at the menu bar.

›Settings, the system configuration

In the system configuration, the software is set up for operation prior to running the first application, i.e. a configuration is set up with the connected hardware. The configuration of the attached hardware is automatically detected in a hardware scan. Each of these hardware configurations allows any number of "methods" and "work lists". Different configurations can work in parallel (see Connection Possibilities).

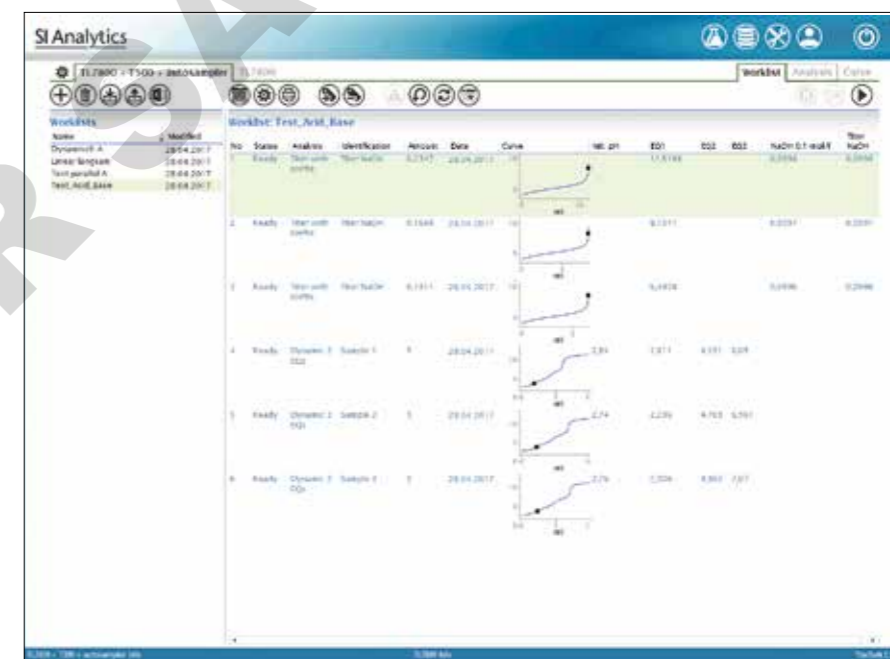

Titration Center

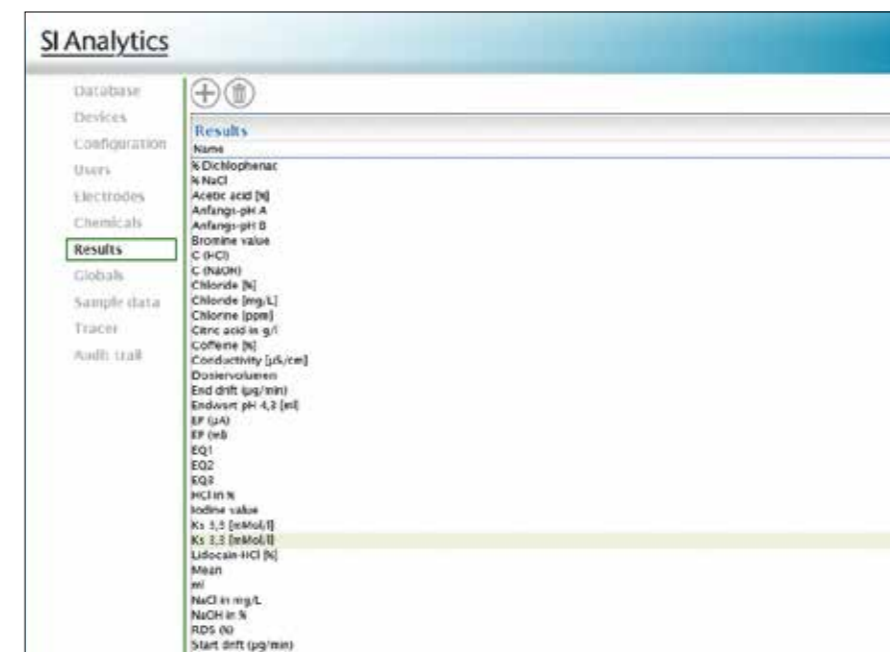

System Configuration

TitriSoft 3.3

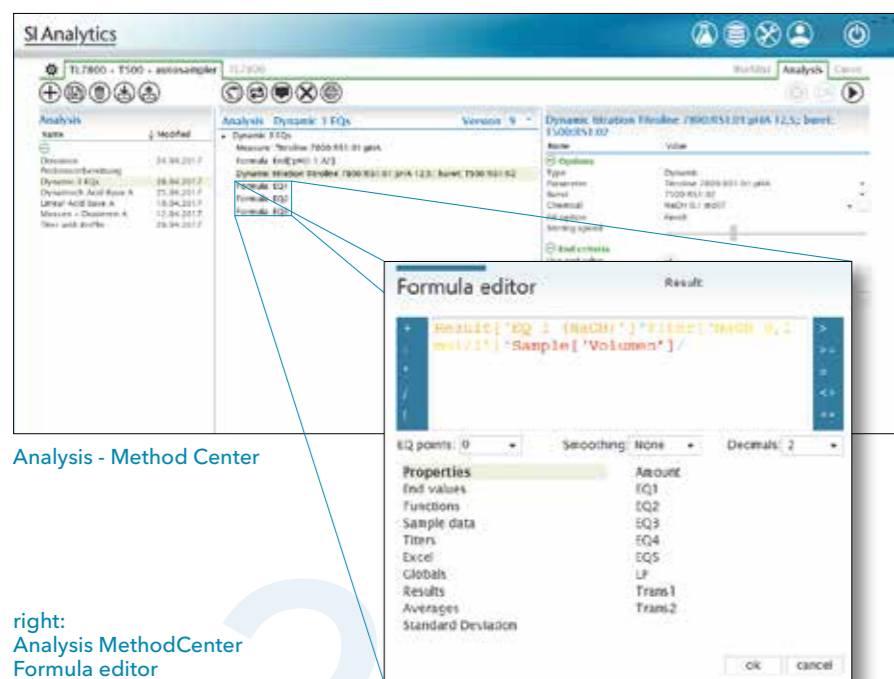

Analysis - Method Center

right:
Analysis MethodCenter
Formula editor

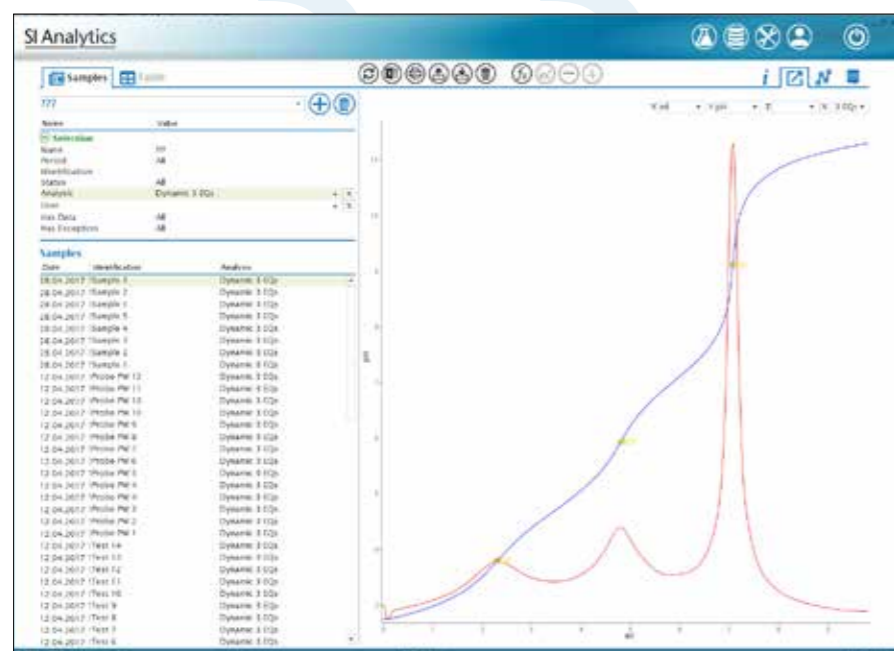

Database Center - Sample view

›Analysis, your Method Center

This is where you set up and save your titration methods. Even complex methods can be installed with a few mouse clicks. Adjustment of the titration parameters is facilitated by the use of symbolic slide controls. Functions such as waiting time, IF loops, repetition, dosings and measurements in addition to the titration parameters and calculation formulas provide virtually unlimited options for method procedures.

›Database, your Data Storage

Titration curves, results, measured values and used methods of all titrations are stored in the database. These data can be selected by sample name, date, user and method and loaded in a few seconds.

You can display the information of the performed titrations as a graphic, result or measured value listing. Each stored titration can be subsequently optimized according to your needs, For example, you can add, save, and print subsequent calculations with the curve. A subsequent data export in ASCII or Excel format is possible at any time. In the TitriSoft 3.3 new filter functions have been added. Individual filters can be set by date, user, method, and the selected records are then listed as table form. These results lists can also be exported in Excel format, printed or saved as a PDF file.

›Worklists, your clearly structured workplace

›Worklists is the place where you carry out your daily jobs, i.e. select methods, enter sample names and origin weighed-in quantities, start the work list and display (and print if desired) the results at the end of a titration. The work list shows the individual samples with the associated methods and their characteristics such as sample name, number, status, date, time, results and events and other freely configurable sample data, e.g. density.

During the process you can follow the titration under „curve“ or directly via the worklist. You can, however, simply allow the samples to be processed in the background and use the PC for other tasks or start an additional titration with another configuration in parallel.

When working with the TW *alpha* plus and TW 7400 sample changer, you can adjust various settings such as skip empty items, rinse and waiting options.

Documentation, which is in accordance with GLP and ISO 9000 directives, can be produced in a number of different forms; tables, lists, curves or individual printouts with curves. In addition results can be saved in ASCII or CSV format, external documentation programs may be accessed and results transferred directly, e.g. into a LIMS.

Name	Date	Identifikation	Analysis	Amount	ED1	ED2	ED3
28.04.2017 14.31	Sample 1	Dynamisch 1 EQ2	1.166	4.902	7.67		
28.04.2017 14.19	Sample 2	Dynamisch 1 EQ2	2.230	4.769	6.961		
28.04.2017 14.06	Sample 3	Dynamisch 1 EQ2	1.811	4.261	6.301		
28.04.2017 13.52	Sample 4	Dynamisch 1 EQ2	2.211	4.691	6.88		
28.04.2017 13.48	Sample 5	Dynamisch 1 EQ2	2.248	4.691	6.88		
28.04.2017 13.37	Sample 6	Dynamisch 1 EQ2	4.879	4.461	6.461		
28.04.2017 13.24	Sample 7	Dynamisch 1 EQ2	5.201	4.061	6.061		
12.04.2017 13.27	Probe PW12	Dynamisch 1 EQ2	1.708	3.953	4.926		
12.04.2017 13.20	Probe PW11	Dynamisch 1 EQ2	1.701	3.976	4.916		
12.04.2017 13.14	Probe PW10	Dynamisch 1 EQ2	1.378	3.915	4.438		
12.04.2017 13.08	Probe PW10	Dynamisch 1 EQ2	1.467	3.721	4.673		
12.04.2017 13.07	Probe PW9	Dynamisch 1 EQ2	1.433	3.536	3.93		
12.04.2017 13.07	Probe PW8	Dynamisch 1 EQ2	1.446	3.549	3.981		
12.04.2017 13.06	Probe PW7	Dynamisch 1 EQ2	1.344	3.099	4.18		
12.04.2017 13.02	Probe PW6	Dynamisch 1 EQ2	1.31	4.21	4.961		
12.04.2017 13.02	Probe PW5	Dynamisch 1 EQ2	1.344	4.267	4.927		
12.04.2017 13.02	Probe PW4	Dynamisch 1 EQ2	1.156	2.863	3.661		
12.04.2017 13.02	Probe PW3	Dynamisch 1 EQ2	1.289	2.847	4		
12.04.2017 13.02	Probe PW2	Dynamisch 1 EQ2	1.236	4.219	4.417		
12.04.2017 13.02	Probe PW1	Dynamisch 1 EQ2	1.342	4.262	4.417		
12.04.2017 13.02	Test 14	Dynamisch 1 EQ2	0.992	4.121	4.3		
12.04.2017 13.02	Test 13	Dynamisch 1 EQ2	0.960	1.581	1.661		
12.04.2017 13.02	Test 12	Dynamisch 1 EQ2	1.162	4.461	4.661		
12.04.2017 13.02	Test 11	Dynamisch 1 EQ2	1.075	4.461	4.661		
12.04.2017 13.02	Test 10	Dynamisch 1 EQ2	0.754	4.461	4.661		
12.04.2017 13.02	Test 9	Dynamisch 1 EQ2	0.274	4.461	4.661		
12.04.2017 13.02	Test 8	Dynamisch 1 EQ2	1.71	4.461	4.661		
12.04.2017 13.02	Test 7	Dynamisch 1 EQ2	1.918	4.175	4.527		
12.04.2017 13.02	Test 6	Dynamisch 1 EQ2	4.461	4.461	4.461		
12.04.2017 13.02	Test 5	Dynamisch 1 EQ2	1.872	4.8	4.461		
12.04.2017 13.02	Test 4	Dynamisch 1 EQ2	2.3	11.2	4.461		
12.04.2017 13.02	Test 3	Dynamisch 1 EQ2	0.904	4.461	4.461		
12.04.2017 13.02	Test 2	Dynamisch 1 EQ2	1.275	1.827	1.461		
12.04.2017 13.02	Test 1	Dynamisch 1 EQ2	1.162	4.461	4.461		
12.04.2017 09.58	Test 4	Dynamisch 1 EQ2	4.461	4.461	4.461		
12.04.2017 09.57	Test 3	Dynamisch 1 EQ2	4.461	4.461	4.461		
12.04.2017 09.56	Test 2	Dynamisch 1 EQ2	4.461	4.461	4.461		
12.04.2017 09.55	Test 1	Dynamisch 1 EQ2	4.461	4.461	4.461		
12.04.2017 09.52	Test 1	Dynamisch 1 EQ2	4.461	4.461	4.461		
12.04.2017 09.56	Test 22	Dynamisch 1 EQ2	0.627	4.461	4.461		
12.04.2017 14.59	Test 21	Dynamisch 1 EQ2	0.293	4.461	4.461		
12.04.2017 14.55	Test 20	Dynamisch 1 EQ2	0.909	4.461	4.461		
12.04.2017 14.51	Test 19	Dynamisch 1 EQ2	0.348	4.461	4.461		
12.04.2017 14.47	Test 18	Dynamisch 1 EQ2	0.273	4.461	4.461		
12.04.2017 14.43	Test 17	Dynamisch 1 EQ2	0.34	4.461	4.461		
12.04.2017 14.38	Test 16	Dynamisch 1 EQ2	0.904	0.918	1.106		

Database Center - Tab. view

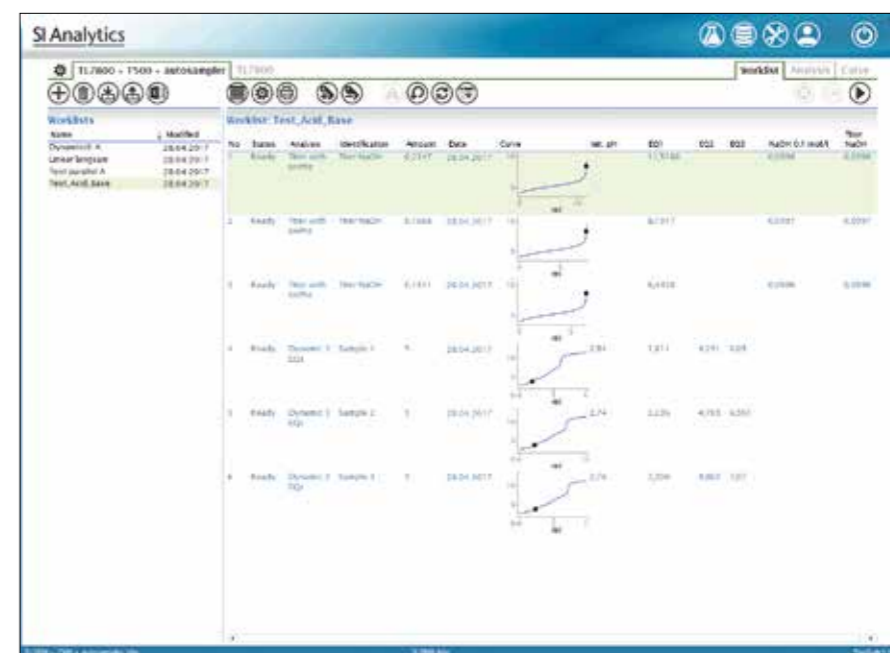

Titration Center - Worklists

6.2 TitriSoft 3.3 P – simply reliable ...

In this case, the “P” stands for “pharmaceutical”. “The TitriSoft 3.3 P fully meets all requirements of the FDA 21 CFR Part 11 regulation regarding „Electronic Records”, „Electronic Signature” and „Audit Trail”.

The FDA (i.e. Food and Drug Administration of the USA) 21 CFR Part 11 regulations describe how to deal with electronically stored data (“Electronic Records”) and how to prepare electronic signatures (“Electronic Signature”). These regulations are binding for all companies offering medical, pharmaceutical or food products and services in the USA.

System requirements

The computer system requirements for TitriSoft 3.3 P are identical with those of the standard version.

Controlled Access

The controlled access guarantees that only authorized individuals have access to the software functions, according to your company's security policy and the FDA requirements.

TitriSoft 3.3 P has 5 different access levels: The “Operator” level only allows you to carry out the routine titrations, whereas the “Advanced User” level is entitled to approve the methods. The highest level, the “Administrator” may set up the users and assign them the user rights. The Administrator even has the permission to delete records, but only after a copy of the database has been generated. This is performed automatically.

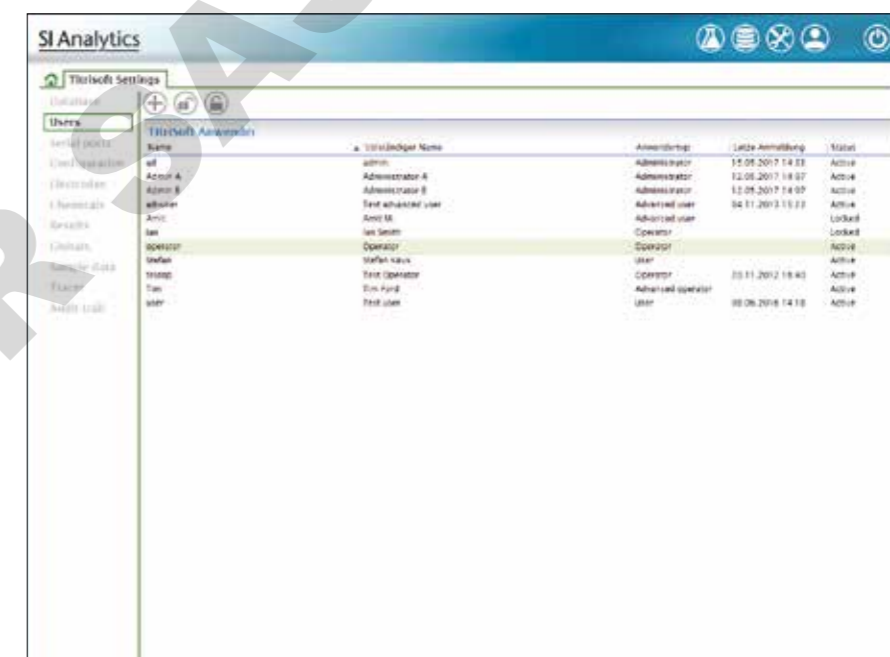

User administration

Comparison between TitriSoft 3.3 and 3.3 P

Functions	TitriSoft 3.3	TitriSoft 3.3 P
Electronic records	■	■
Electronic Signatures	—	■
Audit Trail	—	■
Controlled Access	■	■
Copies of Records	■	■
Straightforward procedure	■	■
All types of titrations	■	■
Comfortable worklists	■	■
Online titration curves	■	■
Clear documentation	■	■
Perfect titration control by PC	■	■
Parallel titration (with multiple configurations, also with a TL 7800 and a piston burette (please refer to page 55))	■	■

User level	Operator	Advanced Operator	User	Advanced User	Administrator
Starting worklists	■	■	■	■	■
Changing worklist settings	—	—	■	■	■
Delete worklists	—	—	—	■	■
Data base, export results again / recalculating	—	■	■	■	■
Generate methods	—	—	■	■	■
Delete methods	—	—	■ 1), 2)	■ 1), 2)	■ 1), 2)
Global system configuration	—	—	—	■	■
System configuration, generate and delete users	—	—	—	—	■

1) A method may only be deleted if no titration / measurement has been carried out yet.
2) For Pharmaversion only: If a method or result has been released, it may not be deleted. The administrator may delete results. But a copy of the database is automatically created before the delete process.

6.3 Ordering Information TitriSoft 3.3 /3.3 P

Type No.	Order No.	Description
TZ 3071	285220717	Titration software TitriSoft 3.3 for all TitroLine® 7XXX titrators and piston burettes TITRONIC® 300/500
TZ 3072	285220727	Titration software TitriSoft like Version 3.3, but 21 CFR, part 11 compliant version

Audit trail

Audit Trail

The 21 CFR Part 11 prescribes that creating methods, modifying passwords or saving results, generates an entry in the Audit Trail. TitriSoft 3.3 P automatically generates an entry in the Audit Trail table as soon as an access to the database has taken place. The local time and the GMT are automatically stored together with this entry in the Audit Trail. Each entry also asks for a comment. The Audit trail or parts of it can be printed out, or a “human” readable digital copy of it, e.g. a PDF file can be generated.

Electronic Signature

Digital analysis results have to be as reliable as classical, manually checked results with a handwritten signature. A digital signature, which is as safe as a handwritten one, can be placed to approve all electronic records. The approver has to enter the name and an additional password. The electronic signature is stored together with the signer’s function, the reason of signing and the date and time.

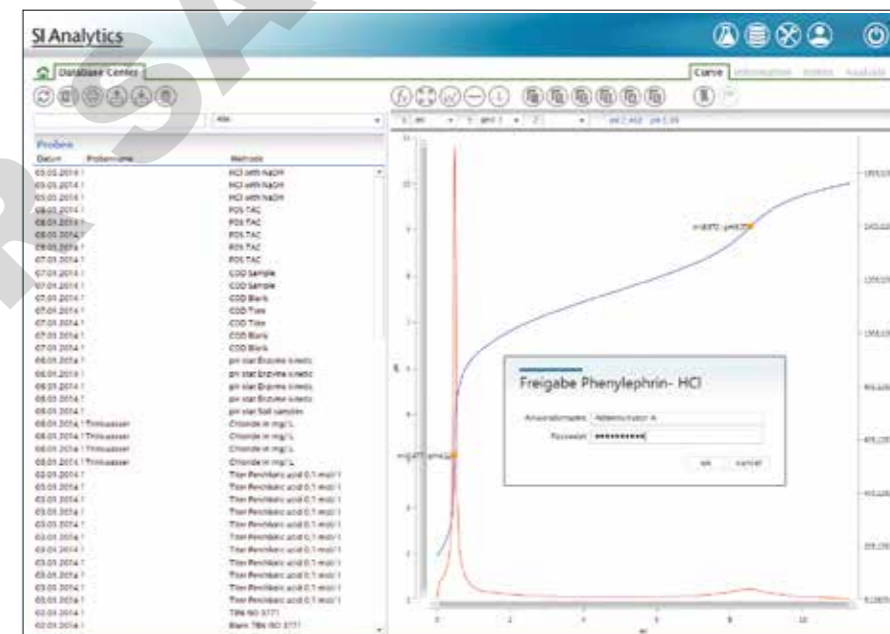

Electronic Signature

6.4 “Parallel” titration with TitroLine® 7800 and TitriSoft 3.3/3.3 P

In combination with the new TitriSoft 3.3 / 3.3 P, TitroLine® 7800 and a piston burette TITRONIC®300 / 500 can be used to perform a so - called „parallel“ titration. This means you only need one titrator and one piston burette to carry out two titrations simultaneously, in parallel.

Typical example:

A TitroLine® 7800 and a sample changer are used to carry out titrations in a configuration of acid base. The pH electrode is connected to the measuring input A. At the same time, a titration of chloride is carried out with a second configuration. The silver electrode is connected to the input B. The titration is carried out with a TITRONIC® 500 piston burette.

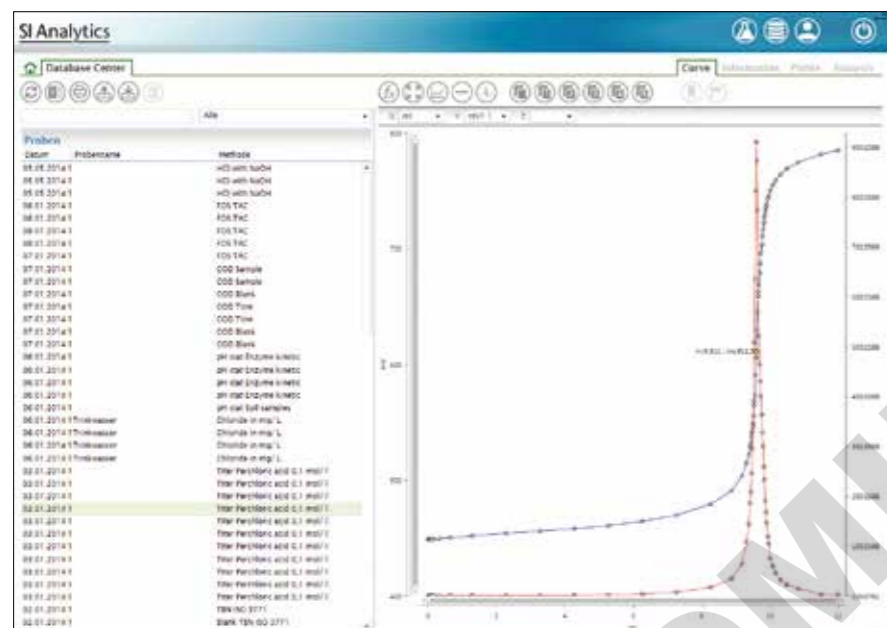

Electronic records

Electronic Records

The 21 CFR Part 11 prescribes how to safeguard and store the generated results over time. Besides regularly making backup copies of the complete database, is it possible to generate readable digital copies of the results, methods, worklists, the Audit Trail, the user administration and the configuration(s). For that purpose, a PDF writer is already integrated in the software. The purchase of expensive third-party software for generating PDF files is not necessary.

Of course the database is password protected against unauthorized access.

Parallel titration

7. Electrodes for titration

The perfect match for reliable measuring results:

SI Analytics sensors and titrators



Content Tiration Electrodes

7. SI Analytics Titration Electrodes	Page 56
7.1 Our Laboratory Sensors	Page 59
7.2 IDS Electrodes	Page 60
7.3 ScienceLine	Page 64
7.3.1 pH combination electrodes	Page 66
7.3.2 pH combination electrodes with temperature sensor	Page 68
7.3.3 Micro pH electrodes	Page 70
7.3.4 Metal combination electrodes	Page 72
7.3.5 Single electrodes: pH glass and metal	Page 74
7.3.6 Single electrodes: reference electrodes	Page 76
7.3.7 Conductivity cells with cable	Page 78
7.3.8 Sensors for ammonia, sodium, oxygen and ion-selective indicator electrodes	Page 80
7.4 Resistance thermometers	Page 82
7.5 OptiLine 6	Page 84
7.6 Solutions	Page 86
7.7 Accessories for electrodes	Page 91
7.8 Connection cables	Page 91

The correct electrode for the titration application is of crucial importance for the correctness and reproducibility of the results. To help you choose the right electrode, we have put together the appropriate electrodes for the most important applications.

Application	Electrode w.o. temp.-sensor	Electrode with integrated temp.-sensor
Acid-base-titrations		
Aqueous, general strong acid and bases	A 7780	A 7780 1M-DIN-ID
Aqueous, difficult applications	N 62, N 61	A 162-2M-DIN-ID
Kjeldahl	A 7780	A 7780 1M-DIN-ID
Alkalinity	N 62, N 61	A 162-2M-DIN-ID
Low ionic liquids	N 64	A 162-2M-DIN-ID
Small sample amounts	N 5900 A	A 157
Titration with sample changer (100-250 ml vessels)	N 65	A 162-2M-DIN-ID
Titration with sample changer (50 ml vessels, micro)	N 5900 A	—
Non aqueous acid base-titrations		
TAN (ASTM 664)	N 6480 eth, OptiLine 6	—
OH-No, NCO-No, FFA saponification No. ...	N 6480 eth	—
TBN (ISO 3771/ASTM 2896)	N 6480 eis, N 6480 eth, OptiLine 6	—
Epoxy value	N 6480 eis, N 6480 eth	—
Titration with perchloric acid/acetic acid	N 6480 eis, N 6480 eth, OptiLine 6	—
Precipitation titrations		
Halogenides (chloride, "salt")	AgCl 62, AgCl 62 RG	—
Halogenides, sample changer	AgCl 65, AgCl 62 RG	—
Pseudo halogenides (cyanide ...)	Ag 6280, Ag 62 RG	—
Surfactants	TEN 1100*	—
Redox titrations		
General, iodometric, permanganometric, cerimetric	Pt 62, Pt 6280, Pt 62 RG Pt 6280	—
Iodine number, peroxid number	Pt 61, Pt 62, Pt 62 RG	—
COD	Pt 61	—
Sample changer, general	Pt 6580	—
Sample changer, COD	Pt 5901	—
Dead stop (SO ₂ bromine no. ...) general	Pt 1200	—
Dead stop (SO ₂ bromine no. ...) sample changer, general and titration vessels	Pt 1400	—
Dead stop (SO ₂ bromine no. ...) sample changer micro	KF 1100	—
KF titrations	KF 1100	—
Complexometric titrations		
Water hardness (Ca/Mg separated)	Ca 1100 PLH, OptiLine 6	—
Water hardness, total	Cu 1100 PLH, OptiLine 6	—
Copper, zinc, nickel, alumina ...	Cu 1100 PLH, OptiLine 6	—

* An applicable reference electrode is required: B 2920+ respectively, B 3520+

7.1 Our laboratory sensors - application orientated and perfectly matched

The standards for pH measurement are very high regarding precision, reproducibility, speed, handling and reliability. Every measurement is different. Different compositions, temperatures, conductivities and viscosities of samples and different measured conditions make for a million of different applications. Only application orientated and perfectly matched systems of electrodes, meters and buffer solutions can meet these standards. At SI Analytics we supply such systems.

The pH electrode is a very important part of the system as it comes in direct contact with the sample and provides the measurement signal. For more than 80 years our focus has been set on the electrode and we have dedicated ourselves to the development and manufacturing of glass electrodes. For a long time our electrodes have been used for the most demanding tasks in labs throughout the world where quality matters, and our customers benefit from this expertise. It all started with a patent on

pH electrodes - today it is a range of several hundred different sensors. Our electrode line includes three product families BlueLine, ScienceLine and TopLine to meet your applications. Whether for ultrapure water, jam, wine, creme or drinking water, SI Analytics offers the right electrode for every application.

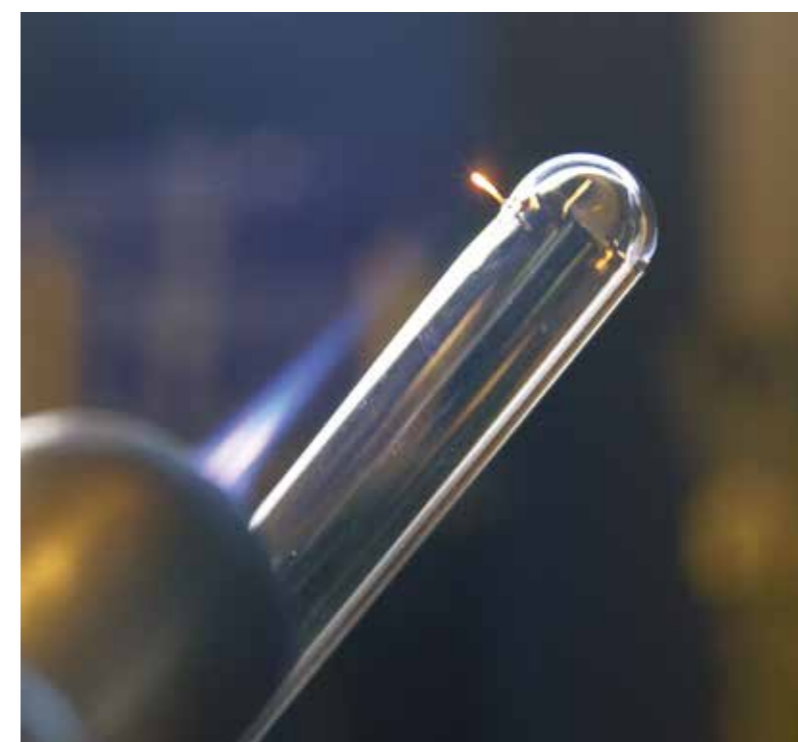

Even today glass blowing talent is still indispensable.

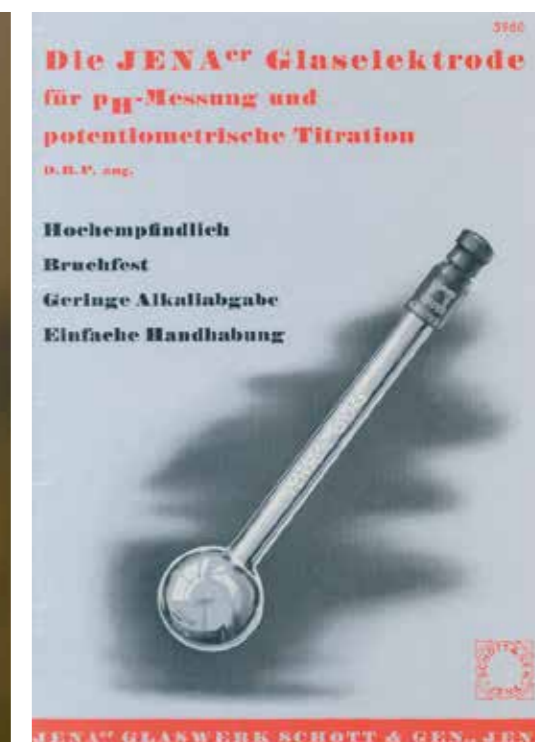

Our first instruction booklet appeared in 1938. In those days the electrochemical pH measuring and the potentiometric titration still needed to be explained.

7.2 IDS

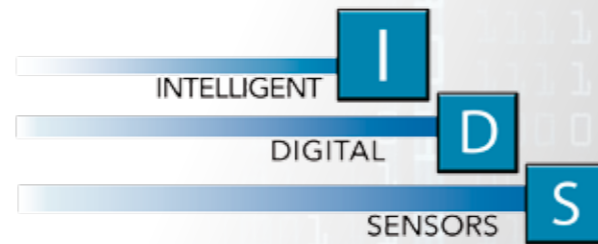

New features

SI Analytics' IDS: Intelligent, Digital Sensors technology for the standard parameters pH, conductivity and dissolved oxygen consists of two components, Digital sensors and matching field or benchtop meters. This new processing of the measured values no longer takes place in the device, exclusively in the sensor so that every sensor has it's own data base when connected.

Built on the basic sensor of the BlueLine and ScienceLine series that have proven themselves tens of thousands of times over, the IDS sensors have added precision and reliability and cover almost any application.

I intelligent:
IDS sensors are intelligent. They log into the device automatically, submit their name, serial number, calibration status and history as well as all parameters.

D digital:
IDS sensors transform the sensitive measuring signals in the sensor head into digital signals and transmit them to the output device without interference and errors.

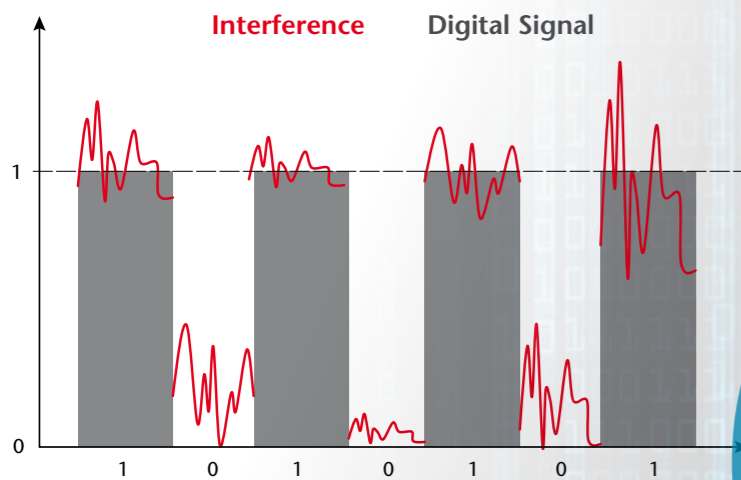

S sensor:
IDS sensors are based on proven and continuously developed sensors by SI Analytics. They cover almost any lab application, like pH, conductivity or dissolved oxygen measurements.



SI Analytics also offers pH meters with IDS:



Cond
pH
O₂

O₂
pH
Cond



SI Analytics also offers Field meters with IDS: **HandyLab 680**



Electrodes

IDS Sensors

Unique.

IDS combines proven measuring technology with new advantages. Based on established electrochemical SI Analytics sensors, but equipped with state-of-the-art measuring electronics IDS save the serial number and calibration data in the sensor. However, IDS also process measuring signals directly and thus improve the data quality. This also allows a current evaluation of the sensor quality by means of the QSC (Quality Sensor Control) function.

IDS combine proven technology with new advantages.

- High-quality, highly developed sensor technology combined with state-of-the-art measuring electronics.
- IDS have saved the serial number and calibration history - error-free and therefore immediately ready for use.
- Current evaluation of the sensor quality for IDS pH electrodes thanks to QSC (Quality Sensor Control).
- IDS conductivity measurement: Two sensors to cover all applications.

- ▶ Higher accuracy than traditional analog sensors
- ▶ Resistant against environmental influences
- ▶ QSC takes the guess work out of the determining the health of your sensor
- ▶ Effortless capture and storage of your sensors latest calibration data
- ▶ Highest possible operator comfort and measuring precision

Benefits
ID Sensors

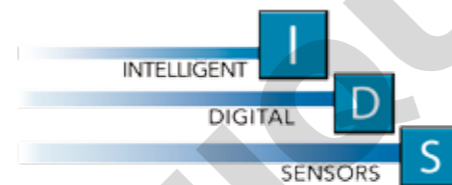

IDS sensors



Electrodes

7.3 ScienceLine Electrodes

The proven high-end laboratory electrodes

In research and development, manufacturing and quality control, our ScienceLine electrodes have become standard for the most demanding measurement tasks. Each electrode has an individual serial number and pH- and metal combination electrodes are supplied with a quality certificate, better making documentation simple and better traceable.

We have kept on improving the glass membrane shapes and types to make the electrodes even more robust, durable and easier to clean. Furthermore, they achieve stable measurement values even faster.

Our ScienceLine electrodes ensure high measurement accuracy and stability and long service life, but are highly adaptable to your measurement tasks. We can offer you a range of electrodes with unmatched versatility and quality.

A perfect all-rounder for basically any application is the platinum diaphragm. A plurality of platinum wires are twisted and fused together. The outflow channels between the wires have constant dimensions. This provides, e.g. compared to the ceramic diaphragm, a pulsation-free discharge and therefore reliable measured values as well as even better self-cleaning.

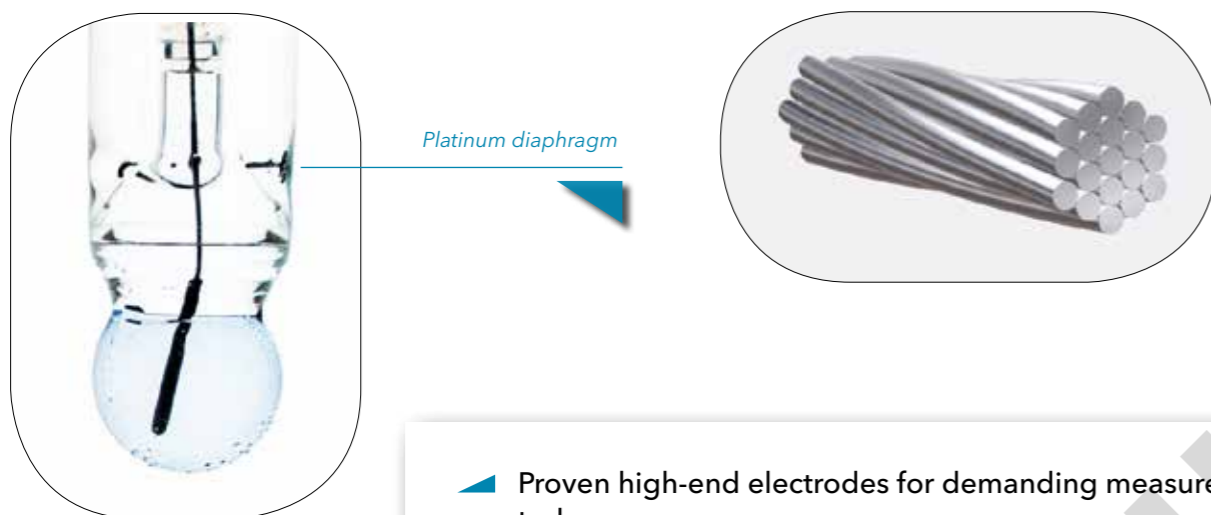

- ▶ Proven high-end electrodes for demanding measurement tasks
- ▶ Double junction Silamid® reference system for fast and stable acquiring of measured values and for longer electrode life.
- ▶ Utmost versatility of pH electrodes is achieved by a large selection of junctions, membrane glass types and shapes, shaft lengths and diameters, ground joints, plug connections and integrated temperature sensors.
- ▶ Each pH and metal combination electrode comes with individual serial number and quality certificate.
- ▶ Large selection of separate glass and reference electrodes, metal combination electrodes, conductivity sensors, ion selective electrodes and ammonia, sodium and oxygen sensors.

Benefits
ScienceLine



Typical examples:

- pH electrodes with a length of up to 600 mm for measurements in very deep vessels
- The N 6003 electrode allows pH measurements even in NMR tubes or other small sample vessels. The A 157 is a micro electrode with an integrated temperature sensor with a 5 mm in diameter.
- For more demanding media, choose among different junctions and membrane glasses. For measurements in samples of low ionic strength there is a choice between e.g. the N 64 and the types A 164. Those feature a ground joint junction, and the A 164 offers a temperature sensor.
- A wide selection of separate reference and glass electrodes completes the offering.

The more stable display of the measured value with Science Line electrodes, as well as their longer life are due to their Silamid reference system. In contrast to the silver/silver chloride reference system of the BlueLine series, the ScienceLine employs. The ScienceLine employs a double junction design where the inner tube is coated with silver which provides for a very stable electrode. Hence, the stability of the potential is much higher.

Silamid derivation

- ▶ The silamid reference is a closed dissipating element in which a glass tube is coated with silver and filled with silver.
- ▶ Compared to a silver chlorinated silver wire, the potential setting area is significantly increased.
- ▶ The watt plug is an inner second diaphragm.
- ▶ Electrodes with a silamide reference therefore have an even longer lifetime compared to electrodes with Ag / AgCl wire as well as an even more stable and reliable measurement.

Benefits
Silamid

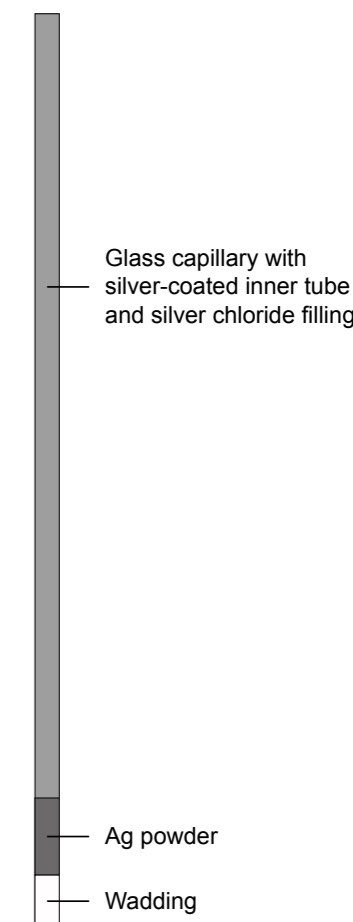

7.3.1 ScienceLine pH combination electrodes

pH combination electrodes with plug head and fixed cable

Reference system: Silamid®
Shaft material: glass
Zero point: pH = 7.0 ± 0.3
Electrolyte: KCl 3 mol/l
 (except
 N 6250: KCl
 4.2 mol/l,
 A 7780 and
 L 7780: gel
 electrolyte,
 L 8280:
 Referid®
 electrolyte)
Membrane shape: sphere
pH range: 0 to 14
Connection cable for plug head: e.g. L 1 A
 (See also page with connection cables)
fixed cable: 1 m long, with plug A acc. to DIN 19262 or with BNC plug



N 61
 N 52 A
 N 52 BNC
 N 61 eis
 N 62
 N 6180
 N 6280
 N 64
 H 6480 eis
 H 6480 eth
 N 6480 eth 2 M
 -DIN ID
 N 65
 H 65
 N 6580
 N 6980
 A 7780

Order No.	Type No.	Length L [mm]	Ø [mm]	Junction	pH-glass	Temp. range [°C]	Connection	Remarks
285101260	A 7780	120	12	3 x ceramic	A	-5 to +80	plug head	gel electrolyte
285100494	N 52 A	120	12	platinum	A	-5 to +100	DIN plug ²⁾	
285105451	N 52 BNC	120	12	platinum	A	-5 to +100	BNC plug ²⁾	
285100001	N 61	170	12	platinum	A	-5 to +100	plug head	
285100018	N 6180	170	12	ceramic	A	-5 to +100	plug head	
285092661	N 61eis	170	12	3 x platinum	A	+10 to +40	plug head	electrolyte L 5014, Ag/AgCl ref.
285100034	N 62	120	12	platinum	A	-5 to +100	plug head	
285100042	N 6280	120	12	ceramic	A	-5 to +100	plug head	
285100059	N 64	170	12	ground joint	A	-5 to +100	plug head	
285092337	N 6480 eis	170	12	ground joint	A	+10 to +40	plug head	electrolyte L 5014, Ag/AgCl ref.
285092329	N 6480 eth	170	12	ground joint	A	0 to +40	plug head	electrolyte L 5014, Ag/AgCl ref.
285092340	N 6480 eth 2 M-DIN ID	170	12	ground joint	A	1 to +40	DIN plug	ID function
285100067	N 65	103 ¹⁾	10	platinum	A	-5 to +100	plug head	standard taper NS 14.5
285102516	N 6580	103 ¹⁾	10	ceramic	A	-5 to +100	plug head	standard taper NS 14.5
285101709	N 6980	103 ¹⁾	10	ground joint	A	-5 to +100	plug head	standard taper NS 14.5

¹⁾ Length from upper end of standard taper
²⁾ with 1 m fixed cable

7.3.2 ScienceLine pH combination electrodes with temperature sensor

pH combination electrodes with temperature sensor

Reference system: Silamid®
Shaft material: glass
Diameter: 12 mm
Zero point: pH = 7.0 ± 0.3
Electrolyte: KCl 3 mol/l
Temperature sensor: Pt 1000
Membrane shape: sphere
pH range: 0 to 14
Connection cable:
 for SMEK-plug head: e.g. LS 1 ANN
 (See also page with connection cables)
fixed cable: 1 m long, with plug A acc. to DIN 19262 or with BNC plug, as well as plug for temperature sensor



N 1051 A
N 1051 BNC
N 1052 A
N 1052 BNC

A 161 1M DIN ID
A 161 1M BNC ID
A 161 IDS
A 162 2M DIN ID
A 162 IDS

A 164 1M DIN ID
A 164 1M BNC ID

A 7780 NTC30
A 7780 1M DIN ID
A 7780 1M BNC ID
A 7780 IDS

Order No.	Type No.	Length L [mm]	Junction	pH-glass	Temp.-range [°C]	Connection	Remarks
285130250	A 161 1M-BNC-ID	170	platinum	A	-5 to +100	BNC ¹⁾ + 4-mm plug	ID function
285130240	A 161 1M-DIN-ID	170	platinum	A	-5 to +100	DIN ¹⁾ + 4-mm plug	ID function
285100090	A 161 IDS	170	platinum	A	-5 to +100	IDS plug	IDS function
285130275	A 162 2M-DIN-ID	120	platinum	A	-5 to +100	DIN ¹⁾ + 4-mm plug	DS function
285100120	A 162 IDS	120	platinum	A	-5 to +100	IDS plug	IDS function
285130290	A 164 1M-BNC-ID	170	ground joint	A	-5 to +100	BNC ¹⁾ + 4-mm plug	ID function
285130280	A 164 1M-DIN-ID	170	ground joint	A	-5 to +100	DIN ¹⁾ + 4-mm plug	ID function
285130210	A 7780 1M-BNC-ID	120	3 x ceramic	A	-5 to +80	BNC ¹⁾ + 4-mm plug	ID function
285130200	A 7780 1M-DIN-ID	120	3 x ceramic	A	-5 to +80	DIN ¹⁾ + 4-mm plug	ID function
285101080	A 7780 IDS	120	3 x ceramic	A	-5 to +80	IDS plug	IDS function
285130290	A 7780 NTC30 DIN-N	120	3 x ceramic	A	-5 to +80	DIN ¹⁾ + 4-mm plug	for portable Knick pH Meter
285100510	N 1051 A	170	platinum	A	-5 to +100	IDS plug	IDS function
285100500	N 1051 BNC	170	platinum	A	-5 to +100	BNC ¹⁾ + 4-mm plug	
1054512	N 1052 A	120	platinum	A	-5 to +100	DIN ¹⁾ + 4-mm plug	
285100380	N 1052 BNC	120	platinum	A	-5 to +100	BNC ¹⁾ + 4-mm plug	

¹⁾ with 1 m fixed cable

7.3.3 ScienceLine micro combination electrodes

pH combination electrodes with temperature sensor

Reference system: Silamid®
Shaft material: glass
Diameter: 12 mm
Zero point: pH = 7.0 ± 0.3
Electrolyte: KCl 3 mol/l
Temperature sensor: Pt 1000
Membrane shape: sphere
pH range: 0 to 14
Connection cable:
 for SMEK-plug head: e.g. LS 1 ANN
 (See also page with connection cables)
fixed cable: 1 m long, with plug A acc. to DIN 19262 or with BNC plug, as well as plug for temperature sensor

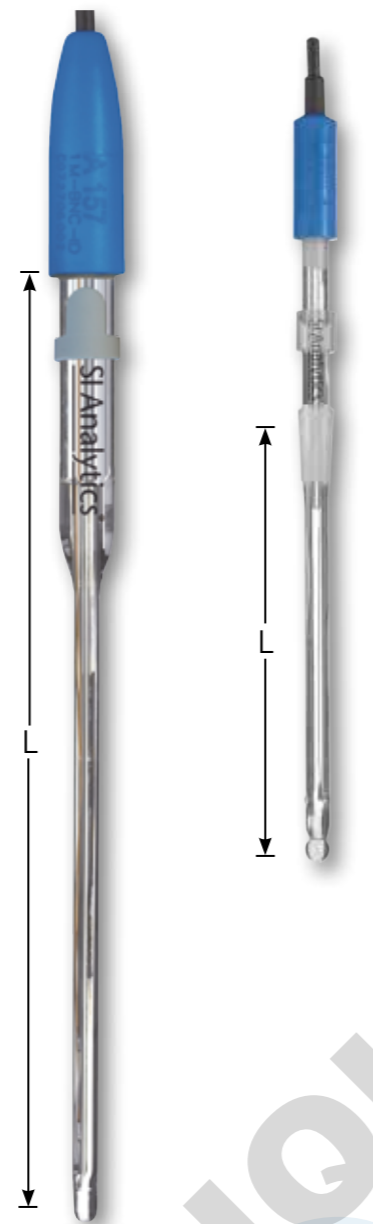

A 157 1M BNC ID
 A 157 1M DIN ID
 A 157 IDS

N 5900 A
 N 5901
 N 5904

Order No.	Type No.	Length L [mm]	Ø [mm]	Junction	pH-glass	Membrane shape	Temp.-range [°C]	Range [pH]	Connection	Remarks
Micro										
285100080	A 157 IDS	70/130	12/5	platinum	A	cylindrical	-5 to +100	0 to 14	IDS plug	IDS function
285130160	A 157 1M-DIN-ID ¹⁾	70/130	12/5	platinum	A	cylindrical	-5 to +100	0 to 14	DIN plug ³⁾	ID function
285130170	A 157 1M-BNC-ID ¹⁾	70/130	12/5	platinum	A	cylindrical	-5 to +100	0 to 14	BNC plug ³⁾	ID function
285105135	N 5900 A	96 ²⁾	5	platinum	A	sphere	-5 to +100	0 to 14	DIN plug ³⁾	Ag/AgCl ref.
285105846	N 5901	160 ²⁾	6	platinum	A	sphere	-5 to +100	0 to 14	plug head	Ag/AgCl ref.
285105879	N 5904	200 ²⁾	6	platinum	A	sphere	-5 to +100	0 to 14	plug head	Ag/AgCl ref.

¹⁾ with integrated temperature sensor Pt 1000
²⁾ Length from upper end of standard taper (Standard taper NS 7.5)
³⁾ with 1 m fixed cable

7.3.4 ScienceLine Metal combination electrodes

Metal combination electrodes with Silver/Silverchloride reference system, plug head and connection cable

Temperature range: -5 to +100 °C
(except Pt 6140: +10 to +40 °C)

Reference system: Silamid®

Shaft material: glass

Electrolyte: KCl 3 mol/l
(See also remarks)

Connection cable: e.g. L 1 A
(See also page with connection cables)

fixed cable: 1 m long, with plug A acc. to DIN 19262 or with BNC plug



Metal-Reference electrodes with pH glass membrane reference system and plug head for titrations

Temperature range: -5 to +100 °C

Reference system: pH glass membrane
Type A

Shaft material: glass

Length: 120 mm

Diameter: 12 mm

Connection cable for plug head: z.B. L 1 A
(please refer to the page "connection cables")

AgCl 62
AgCl 6280
AgCl 65
Ag 42 A
Ag 6180
Ag 62 IDS
Ag 6280
Ag 6580
Au 6280

Pt 61
Pt 6180
Pt 62
Pt 6280
Pt 6580

Pt 6880
Pt 6980

Pt 62 RG
Ag 62 RG
AgCl 62 RG
AgS 62 RG
Pt 62 RG IDS

Pt 8280

Pt 5900 A
Pt 5900 BNC
Pt 5901

Order No.	Type No.	Length L [mm]	Junction	Ø [mm]	Sensor Metal, shape	Connection	Remarks
285102208	Ag 6180	170	ceramic	12	Ag, cap, 5 mm Ø	plug head	electrolyte L 2114, Ag/AgCl ref.
285102150	Ag 62 IDS	120	platinum	12	Ag, cap, 5 mm Ø	plug head	IDS
285102090	Ag 62 RG	120	-	12	Pt bearing - silver coated,		
285102343	Ag 6280	120	ceramic	12	Ag, cap, 5 mm Ø	plug head	electrolyte L 2114, Ag/AgCl ref.
285102216	Ag 6580	1031)	ceramic	10	Ag, cap, 5 mm Ø	plug head	electrolyte L 2114, Ag/AgCl ref.
285102100	AgCl 62 RG	120	-	12	Pt-bearing - silver coated, chlorinated, ring, 6 mm Ø	plug head	
285102413	AgCl 62 ³⁾	120	platinum	12	Ag, cap, 5 mm Ø	plug head	electrolyte L 2114, Ag/AgCl ref.
285102351	AgCl 6280 ³⁾	120	ceramic	12	Ag, cap, 5 mm Ø	plug head	electrolyte L 2114, Ag/AgCl ref.
1061051	AgCl 65 ³⁾	1031)	platinum	12	Ag, cap, 5 mm Ø	plug head	electrolyte L 2114, Ag/AgCl ref.
285102110	AgS 62 RG	120	-	12	Pt bearing - silver coated, sulfidized, ring, 6 mm Ø	plug head	
285102121	Au 6280	120	ceramic	12	Au, pole, 2 mm Ø	plug head	
285105192	Pt 5900 A	⁹⁶²⁾	platinum	5	Pt, pole, 1 mm Ø	DIN plug ⁴⁾	Ag/AgCl ref.
285105702	Pt 5900 BNC	⁹⁶²⁾	platinum	5	Pt, pole, 1 mm Ø	BNC plug ⁴⁾	Ag/AgCl ref.
285105065	Pt 5901	1602)	platinum	5	Pt, pole, 1 mm Ø	plug head	
285102002	Pt 61	170	platinum	12	Pt, pole, 1 mm Ø	plug head	
285102232	Pt 6180	170	ceramic	12	Pt, pole, 1 mm Ø	plug head	
285102019	Pt 62	120	platinum	12	Pt, pole, 1 mm Ø	plug head	
285102070	Pt 62 RG	120	-	12	Pt, ring, 6 mm Ø	plug head	
285102140	Pt 62 RG IDS	120	-	12	Pt, ring, 6 mm Ø	plug head	IDS
285102249	Pt 6280	120	ceramic	12	Pt, pole, 1 mm Ø	plug head	
285102257	Pt 6580	1031)	ceramic	10	Pt, pole, 1 mm Ø	plug head	
285100075	Pt 6880	120	ceramic	12	Pt, ring, 6 mm Ø	plug head	
285102265	Pt 6980	170	ceramic	12	Pt, ring, 6 mm Ø	plug head	
285102281	Pt 8280	120	KPG®	12	Pt, round, 6 mm Ø	plug head	electrolyte Referid®
285102110	AgS 62 RG	120	-	12	Pt bearing - silver coated, sulfidized, ring, 6 mm Ø	plug head	
285102070	Pt 62 RG	120	-	12	Pt, ring, 6 mm Ø	plug head	

¹⁾ Length from upper end of standard taper; standard taper NS 14.5
²⁾ Length from upper end of standard taper; standard taper NS 7.5
³⁾ Sensor coated with AgCl
⁴⁾ with 1 m fixed cable

7.3.5 ScienceLine Single electrodes: pH glass and metal electrodes

ScienceLine single electrodes

pH glass electrodes

Reference system: Silamid®
 Shaft material: glass, 12 mm Ø
 Zero point: pH = 7.0 ± 0.3
 Membrane shape: sphere
 Connection cable: e.g. L 1 A

Metal electrodes

Shaft material: glass, 12 mm Ø
 (See remarks)



A 1180
H 1180

Ag 1100

KF 1100

Pt 1400
Pt 1200

Pt 1800

Order No.	Type No.	Length L [mm]	pH Glass	Range [pH]	Temp.-range [°C]	Remarks
1057997	A 1180 ¹⁾	120	H	0 to 14	0 to +80	plug head
285103212	H 1180	120	H	0 to 14	10 to +100	plug head

Order No.	Type No.	Length L [mm]	Sensor Metal	Sensor shape	Temp. range [°C]	Remarks
285103607	Ag 1100	120	Ag	cap, 4 mm Ø	-5 to +100	plug head, cable e.g. L 1 A
285102030	KF 1100	96 ¹⁾	Pt ²⁾	2 pole, 1 mm Ø	-30 to +135	shaft 5 mm Ø, standard taper NS 7.5, fixed cable, 2 x 4-mm plug
285103512	Pt 1200	120	Pt ²⁾	2 pole, 1 mm Ø	-30 to +135	plug head, cable e.g. L 1 NN
285103537	Pt 1400	103 ¹⁾	Pt ²⁾	2 pole, 1 mm Ø	-30 to +135	shaft 10 mm Ø, standard taper NS 14.5, cable e.g. L 1 NN
285103553	Pt 1800	120	Pt	ring, 6 mm Ø	-30 to +135	plug head, cable e.g. L 1 A

¹⁾ Length from upper end of standard taper
²⁾ Double platinum electrode

7.3.6 ScienceLine Single electrodes: Reference electrodes

Reference electrodes

Shaft material: glass
 Electrolyte depending on reference system:
 Ag/AgCl: KCl 3 mol/l, e.g. L 300
 Calomel: KCl 4.2 mol/l, e.g. L 420
 Hg/Hg₂SO₄: K₂SO₄ 0.6 mol/l, e.g. L 1254
 pH range: 0 to 14
 Connection cable: e.g. L 1 N

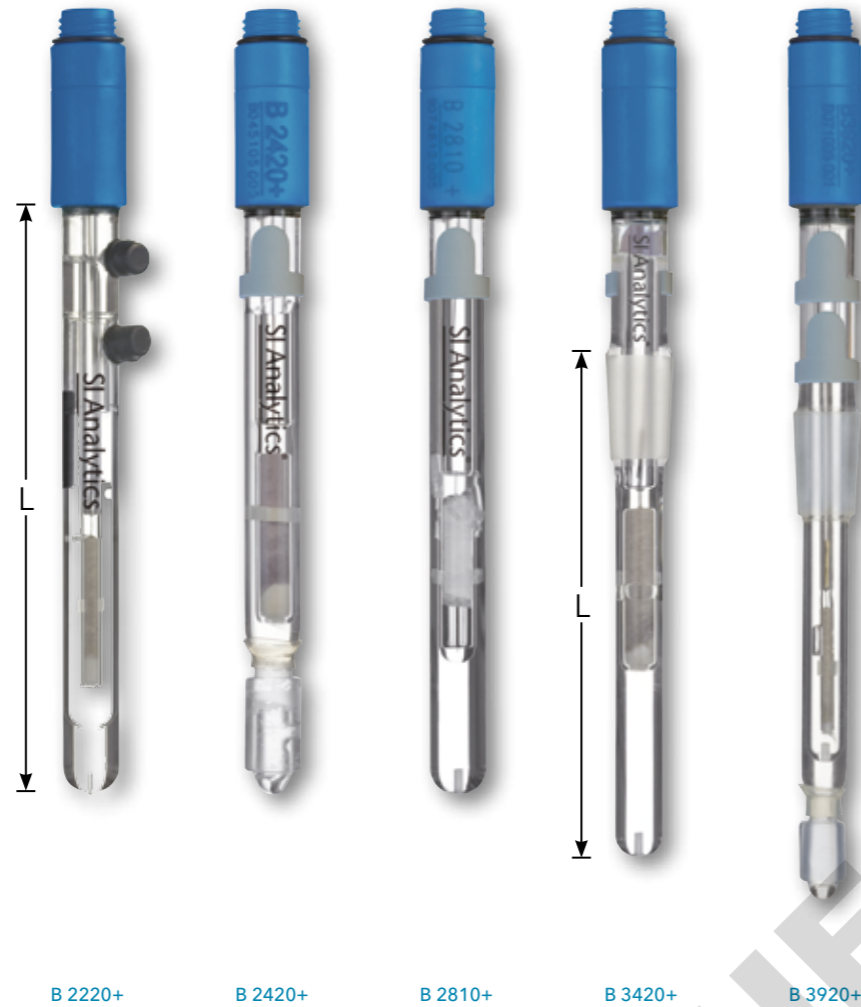

B 2220+

B 2420+

B 2810+
B 2820+
B 2910+
B 2920+

B 3420+
B 3410+
B 3510+
B 3520+
B 3610+

B 3920+

Order No.	Type No.	Length L [mm]	Ø [mm]	Temp. range [°C]	Junction	Reference system	Remarks
1069994	B 2220+	120	12	-5 to +100	platinum	Ag/AgCl	double electrolyte system
1070028	B 2420+	120	12	-5 to +100	ground joint	Ag/AgCl	
1070044	B 2820+	120	12	-5 to +100	ceramic	Ag/AgCl	
1070046	B 2920+	120	12	-5 to +100	platinum	Ag/AgCl	
1070070	B 3420+	103 ¹⁾	10	-5 to +100	ceramic	Ag/AgCl	standard taper NS 14.5
1070073	B 3520+	103 ¹⁾	10	-5 to +100	platinum	Ag/AgCl	standard taper NS 14.5
1070074	B 3610+	103 ¹⁾	10	+15 to +40	ceramic	Hg/Hg ₂ SO ₄	standard taper NS 14.5
1070075	B 3920+	103 ¹⁾	10	-5 to +100	ground joint	Ag/AgCl	double electrolyte system, standard taper NS 14.5

¹⁾ Length from upper end of standard taper

7.3.7 ScienceLine conductivity cells with cable

Conductivity measuring cells with fixed cable and 8-pole plug

Temperature sensor: NTC 30 k Ω

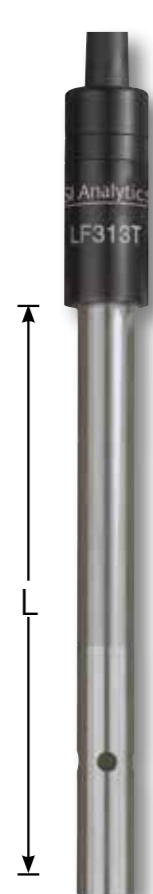

LF 313 T IDS



LF 413 T IDS
LF 413 T 3M IDS



LF 413 T 3M Fork IDS

Order No.	Type No.	Length L [mm]	Ø [mm]	Sensor	Cell const. ~ [cm ⁻¹]	Temp. range [°C]	Meas. range ¹⁾ [µS/cm] . . [mS/cm]	Remarks
285202430	LF 313 T IDS	120	12	Stainless steel	0.1	-5 to +100	0 to 0.2	Ultrapure water conductivity cell with flow-through vessel, stainless steel shaft, cable 1.5 m, IDS function
285202410	LF 413 T-IDS	120	15.3	4 x Graphite	0.475	-5 to +80	1 to 2,000	Plastic shaft, 1.5 m cable, IDS function
285202420	LF 435 T 3M IDS	120	15.3	4 x Graphite	0.475	-5 to +80	1 to 2000	Plastic shaft, 3 m cable, IDS function
285106290	LF 413 T 3M FORK IDS	120	15.3	4 x Graphite	0.47	-5 to +80	1 to 2000	Plastic shaft, 3 m cable, IDS function

DOMINIQUE DUTSCHER SAS

ScienceLine

Electrodes

¹⁾ Outside the recommended ranges measuring errors > 10% can occur with these conductivity measuring cells.

7.3.8 ScienceLine Sensors for ammonia, sodium, oxygen and ion-selective indicator electrodes

Ammonia combination electrode with plug head

Shaft material: plastic, 12 mm Ø
Connection cable: e.g. L 1 A

Sodium combination electrode with plug head

Reference system: Silamid®
Shaft material: glass, 12 mm Ø
Zero point: pNa=2.0
Membrane shape: sphere
Connection cable: e.g. L 1 A

ISE measuring cells

Shaft material: plastic
Length: 120 mm
Fixed cable: 1 m long, with DIN plug

ISE combination electrodes with plug head

Shaft material: plastic
Length: 120 mm



NH 1100

Na 61

TEN 1100 PLH

Cu 1100 PLH
Ca 1100 PLH
F 1100 PLH
PB 1100 PLH

F 60
Cl 60
NO 60
K 60
CA 60
CN 60
AG-S 60
I 60
BR 60
CU 60
PB 60

and ion-selective indicator electrodes

Order No.	Type No.	Length L [mm]	Temp. range [°C]	Meas. range [mg/l]	Remarks
285102808	NH 1100	120	0 to +50	0.1 to 1,000	membrane module replaceable

Order No.	Type No.	Length L [mm]	Junction	Membrane Glass	Temp. range [°C]	Meas. range [pNa]	Remarks
285100026	Na 61	170	platinum	Na	-10 to +80	0 to 6	electrolyte KCl 3 mol/l, aqueous solution NaCl 0.1 mol/l

Order No.	Type No.	Parameter	Temp. range [°C]	pH-range	Measuring range [mg/l]
285216268	Ca 1100 PLH	Calcium	0 to +40	2.5 to 11	0.02 to 40,000
285216273	Cu 1100 PLH	Copper	0 to +80	2 to 6	0.0006 to 6,400
285216295	F 1100 PLH	Fluoride	0 to +80	5 to 7	0.02 to saturated
285216287	Pb 1100 PLH	Lead	0 to +80	4 to 7	0.1 to 20,000
285096980	TEN 1100 PLH	Lead	0 to +80	2 to 11	

Order No.	Type No.	Parameter	Temp. range [°C]	pH-range	Measuring range [mg/l]
285130400	AG-S 60	Sulfide/silver	0 to +80	2 to 12	0.003 to 32,000/ 0.1 to 108,000
285130420	BR 60	Bromide	0 to +80	1 to 12	0.4 to 79,000
285130380	CA 60	Calcium	0 to +40	2.5 to 11	0.02 to 40,000
285130350	Cl 60	Chloride	0 to +80	2 to 12	2 to 35,000
285130390	CN 60	Cyanide	0 to +80	0 to 14	0.2 to 260
285130430	CU 60	Copper	0 to +80	2 to 6	0.0006 to 6400
285130340	F 60	Fluoride	0 to +80	5 to 7	0.02 to saturated
285130410	I 60	Iodide	0 to +80	0 to 14	0.006 to 127,000
285130370	K 60	Potassium	0 to +40	2 to 12	0.04 to 39,000
285130360	NO 60	Nitrate	0 to +40	2.5 to 11	0.4 to 62,000
285130440	PB 60	Lead	0 to +80	4 to 7	0.2 to 20,000

1) Other cable lengths available on request

7.4 Resistance thermometers

Resistance thermometers with 1 m fixed cable

Resistance thermometer with coaxial plug head



W 5780 NN

W 5790 NN
W 5790 PP
W 5791 NN

W 5980 NN

W 2180-KOAX

Resistance thermometers with SMAK plug head

Resistance thermometers with 1 m fixed cable

Order No.	Type No.	Length L [mm]	Ø [mm]	Sensor	Temp. range [°C]	Shaft material	Connection plug
285105221	W 5780 NN	120	6	Pt 1000	-30 to +135	glass	2 x 4 mm Ø
285105254	W 5790 NN	120	4	Pt 1000	-30 to +135	stainless steel	2 x 4 mm Ø
285105776	W 5790 PP	120	4	Pt 1000	-30 to +135	stainless steel	2 x 4 mm Ø
285105262	W 5791 NN	170	4	Pt 1000	-30 to +135	stainless steel	2 x 4 mm Ø
285105287	W 5980 NN	96 ¹⁾	5 NS 7.5	Pt 1000	-30 to +135	glass	2 x 4 mm Ø

Resistance thermometer with coaxial plug head

Order No.	Type No.	Length L [mm]	Ø [mm]	Sensor	Temp. range [°C]	Shaft material
285119030	W 2180-KOAX	120	12	Pt 1000	-30 to +135	glass

¹⁾ length from upper end of standard taper

7.5 OptiLine 6 for photometric titrations

Many titration applications and methods, e.g. N Ph.Eur or USP prescribe the use of an indicator for the titration end point. There are also methods that explicitly require the use of a photometric sensor. The OptiLine 6 is a new photometric sensor that can be used like any other sensor. Thanks to the additional analog BNC / DIN connection, it can be connected to any titrator or even a pH meter with an appropriate measuring input. The power supply is included in the USB hub, which is in the scope of delivery...

Order No.	Type No.	Length L [mm]	Measuring range [mV]	Remarks
285221300	OptiLine 6	132	0 ... 2,000	Adjustable wavelengths

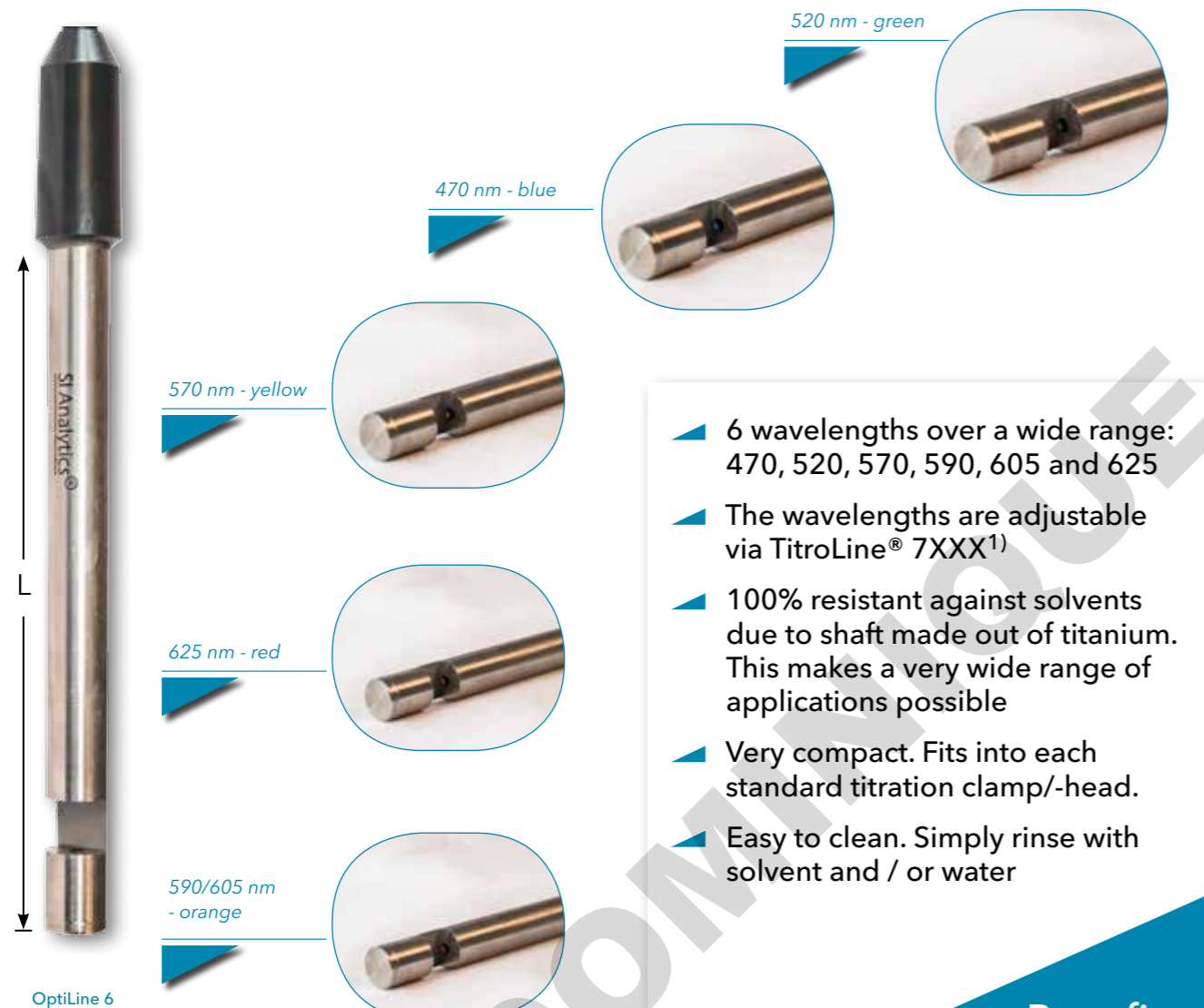

- ▶ 6 wavelengths over a wide range: 470, 520, 570, 590, 605 and 625
- ▶ The wavelengths are adjustable via TitroLine® 7XXX¹⁾
- ▶ 100% resistant against solvents due to shaft made out of titanium. This makes a very wide range of applications possible
- ▶ Very compact. Fits into each standard titration clamp/-head.
- ▶ Easy to clean. Simply rinse with solvent and / or water

Benefits
OptiLine

¹⁾ When using the analog BNC / DIN connector, the wavelengths are set with a software tool via PC.

The OptiLine 6 is connected to the titrator TitroLine® 7000, 7750 and 7800 via the USB connector. The sensor is supplied with current and detected as a digital sensor. This allows the setting of the wavelengths and other parameters such as the intensity via the Titrator or the software TitriSoft within the titration method.

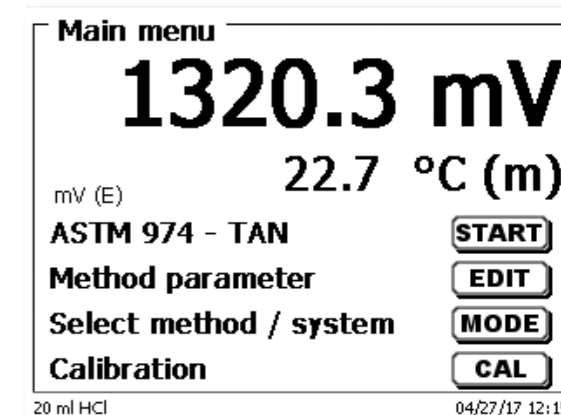
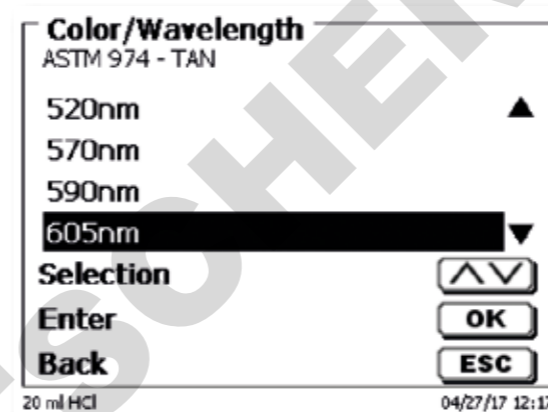

Typical applications for the OptiLine 6:

- ▶ Titrations according to PH.Eur. and USP, which require the use of an indicator
- ▶ Titration of Chondroitin sulfate-sodium according to Ph.Eur. and USP
- ▶ Determination of the carboxyl end groups in PET (non -aqueous titration)
- ▶ TAN/TBN according to ASTM D974 (non -aqueous titration)
- ▶ Titration of sulfate (indicator Thorin)
- ▶ Determination of Ca/Mg and total hardness. All other complexometric titrations can be carried out as well

Specifications OptiLine 6

Shaft diameter	12 mm
Shaft length:	132 mm
Minimum immersion depth:	25 mm
Shaft material:	Titanium
Cable:	fixed, 2 m
Connections:	USB-plug A, BNC-plug with BNC-DIN-adapter
Power supply:	via USB
Measuring range:	0 - 2000 mV
Temperature range:	0 - 50 °C
pH-range:	0 - 14
Adjustable wavelength (nm):	470, 520, 570, 590, 605 and 625

7.6 Solutions

Buffer solutions in the unique double-end ampoules offer a particularly high degree of reliability and measuring accuracy.

The exactness of the pH measurement is mainly dependent on the accuracy of calibration. This again highly depends on the reliability of the buffer.

Hermetically sealed in the glass ampoule and sterilized with hot steam, same as a pharmaceutical product, the buffer solutions free of preservation agent have an extremely long shelf life and guarantee continuously error-free characteristics.

The ampoules can be easily opened at the breaking point. Tools are not required. Since refilling is not possible, you are always ensured of maximum calibration reliability.

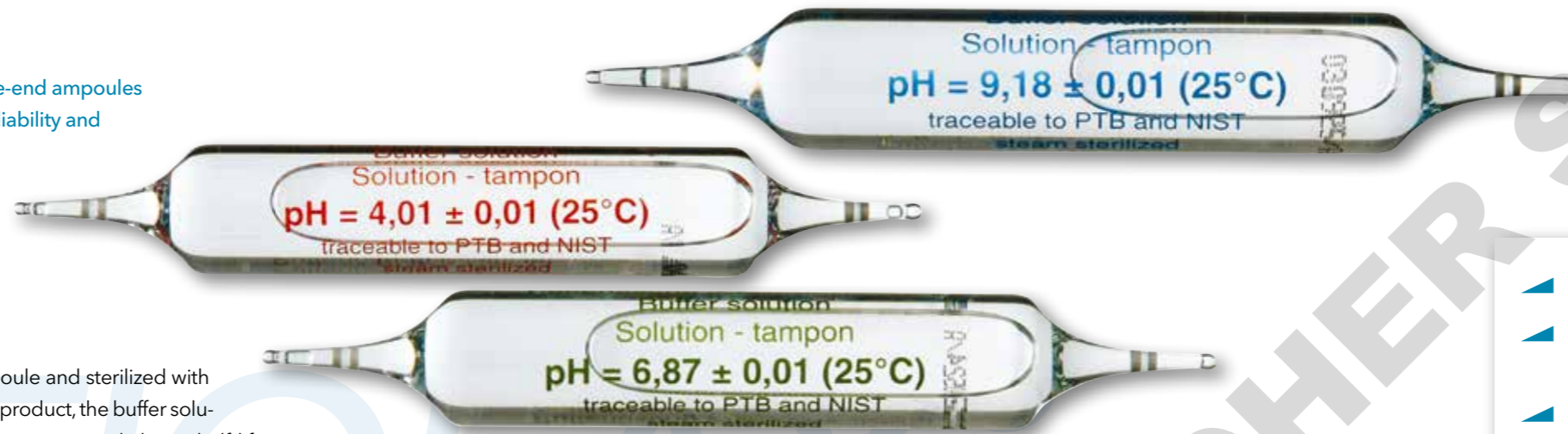

- ▶ Highest measurement reliability
- ▶ Extremely long storage times, thanks to hot-steam sterilization
- ▶ No preservative agents
- ▶ Maximize calibration reliability

Benefits
Ampoules

Standard buffer solutions according to DIN 19 266
Hot steam sterilized for longer stability, no preservation agents used.

Order No.	Type No.	pH value at 25 °C	Contents
285137977	L 4791	1.68	60 FIOLAX® ampoules à 20 ml*, with manufacturer's certificate
285138246	L 4794	4.01	60 FIOLAX® ampoules à 20 ml*, with manufacturer's certificate
285138254	L 4796	6.87	60 FIOLAX® ampoules à 20 ml*, with manufacturer's certificate
285138262	L 4799	9.18	60 FIOLAX® ampoules à 20 ml*, with manufacturer's certificate
285138402	L 4790	4.01/6.87	2 x 30 FIOLAX® ampoules à 20 ml*, with manufacturer's certificate
285137985	L 4797	1.68/6.87/9.18	3 x 20 FIOLAX® ampoules à 20 ml*, with manufacturer's certificate
285138238	L 4798	4.01/6.87/9.18	3 x 20 FIOLAX® ampoules à 20 ml*, with manufacturer's certificate
285138279	L 4893/Set	4.01/6.87	2 x 9 FIOLAX® ampoules à 20 ml*, with manufacturer's certificate, with electrolyte solution L 3008

Order No.	Type No.	pH value at 25 °C	Contents
285137841	L 168	1.68	1,000 ml in DURAN® glass bottle, with manufacturer's certificate
285137677	L 1684	1.68	250 ml in DURAN® glass bottle, with manufacturer's certificate
285138098	L 401	4.01	1,000 ml in DURAN® glass bottle, with manufacturer's certificate
285138008	L 4014	4.01	250 ml in DURAN® glass bottle, with manufacturer's certificate
285138102	L 687	6.87	1,000 ml in DURAN® glass bottle, with manufacturer's certificate
285138016	L 6874	6.87	250 ml in DURAN® glass bottle, with manufacturer's certificate
285138119	L 918	9.18	1,000 ml in DURAN® glass bottle, with manufacturer's certificate
285138024	L 9184	9.18	250 ml in DURAN® glass bottle, with manufacturer's certificate

* 20 ml volume = ~17 ml content

Technical buffer solutions
Hot steam sterilized for longer stability, no preservation agents used.

Order No.	Type No.	pH value at 25 °C	Contents
285138213	L 4694	4.00	60 FIOLAX® ampoules à 20 ml*, with manufacturer's certificate
285138221	L 4697	7.00	60 FIOLAX® ampoules à 20 ml*, with manufacturer's certificate
285138205	L 4691	10.01	60 FIOLAX® ampoules à 20 ml*, with manufacturer's certificate
285138398	L 4690	4.00/7.00	2 x 30 FIOLAX® ampoules à 20 ml*, with manufacturer's certificate
285138192	L 4698	4.00/7.00/10.01	3 x 20 FIOLAX® ampoules à 20 ml*, with manufacturer's certificate
285138632	L 4895/Set	4.00/7.00	2 x 9 FIOLAX® ampoules à 20 ml*, with manufacturer's certificate, with electrolyte solution L 3008,

Order No.	Type No.	pH value at 25 °C	Contents
285138727	L 400	4.00	1,000 ml in DURAN® glass bottle, with manufacturer's certificate
285138032	L 4004	4.00	250 ml in DURAN® glass bottle, with manufacturer's certificate
285138735	L 700	7.00	1,000 ml in DURAN® glass bottle, with manufacturer's certificate
285138049	L 7004	7.00	250 ml in DURAN® glass bottle, with manufacturer's certificate
285138719	L 100	10.01	1,000 ml in DURAN® glass bottle, with manufacturer's certificate
285138057	L 1004	10.01	250 ml in DURAN® glass bottle, with manufacturer's certificate

* 20 ml volume = ~17 ml content

Solutions

Color-coded technical buffer solutions in plastic bottles

Order No.	Type No.	pH value at 25 °C	Contents
285139156	LC 4004 K	4.01	250 ml in PE bottle
285139189	LC 7004 K	7.00	250 ml in PE bottle
285139218	LC 1004 K	10.01	250 ml in PE bottle



Electrolyte solutions, aqueous for reference electrodes, as electrolyte bridges and for storage

Order No.	Type No.	Description	Contents
285136956	L 101	potassium chloride solution 1 mol/l	1,000 ml in DURAN® glass bottle, sterilized
285138649	L 1254	potassium sulfate solution 0.6 mol/l	250 ml in DURAN® glass bottle
285138151	L 200	low temperature electrolyte (-30 °C)	1,000 ml in DURAN® glass bottle
285138365	L 2004	low temperature electrolyte (-30 °C)	250 ml in DURAN® glass bottle
285138349	L 2114	2 mol/l KNO ₃ + 0.001 mol/l KCl for Ag combination electrodes	250 ml in DURAN® glass bottle
285136923	L 2214	2 mol/l KNO ₃ + 0.001 mol/l KCl for Ag combination electrodes, thickened	250 ml in DURAN® glass bottle
285138332	L 2224	potassium chloride solution 2 mol/l	250 ml in DURAN® glass bottle
285138554	L 300	potassium chloride solution 3 mol/l	1,000 ml in DURAN® glass bottle, sterilized
285138427	L 3004	potassium chloride solution 3 mol/l	250 ml in DURAN® glass bottle, sterilized
285138505	L 3008	potassium chloride solution 3 mol/l	50 ml in PE bottle
285138419	L 3014	potassium chloride solution 3 mol/l, Ag/AgCl saturated	250 ml in DURAN® glass bottle
285138468	L 310	potassium chloride solution 2 mol/l, gel for sterilizable electrodes	1,000 ml in DURAN® glass bottle
285138484	L 3104	potassium chloride solution 2 mol/l, gel for sterilizable electrodes	250 ml in DURAN® glass bottle
285138702	L 320 K	potassium chloride solution 2 mol/l, gel for Ag ₂ S electrodes	1,000 ml in DURAN® glass bottle
285138143	L 350	potassium chloride solution 3.5 mol/l	1,000 ml in DURAN® glass bottle, sterilized
285138127	L 3504	potassium chloride solution 3.5 mol/l	250 ml in DURAN® glass bottle, sterilized
285138587	L 420	potassium chloride solution 4.2 mol/l	1,000 ml in DURAN® glass bottle
285138608	L 4204	potassium chloride solution 4.2 mol/l	250 ml in DURAN® glass bottle
285138590	L 911	storage electrolyte solution, sterilized	1,000 ml in DURAN® glass bottle
285138560	L 9114	storage electrolyte solution, sterilized	250 ml in DURAN® glass bottle

Electrolyte solutions, organic for measurements in organic solutions for reference electrodes and as electrolyte bridges

Order No.	Type No.	Description	Contents
285138324	L 5014	LiCl saturated in glacial acetic acid	250 ml in DURAN® glass bottle
285138308	L 5034	LiCl 1,5 mol/l in ethanol	250 ml in DURAN® glass bottle

Solutions for oxygen measurements

Order No.	Type No.	Description	Contents
285138513	L 6708	electrolyte for oxygen electrodes OX 1100/OX 1100+ /OX 1101	50 ml in PE bottle
285126606	OX 920	electrolyte for oxygen electrodes 9009/61	50 ml in PE bottle
285126614	OX 921	cleaning solution for oxygen electrodes 9009/61	30 ml in PE bottle
285138287	OX 060	zero point solution for oxygen electrodes OX 1100/OX 1100+	60 FIOLAX® ampoules à 20 ml volume = ~17 ml content

Solutions for ammonia measurements

Order No.	Type No.	Description	Contents
285137344	L 6408	electrolyte for ammonia combination electrodes	50 ml in PE bottle



Solutions

Solutions and accessories for conductivity measurements

Order No.	Type No.	Description	Contents
285126503	LF 990	test solution KCl 0.001 mol/l (147 µS/cm)	3 x 6 FIOLAX® ampoules à 20 ml*, with manufacturer certificate
285126511	LF 991	test solution KCl 0.01 mol/l (1.41 mS/cm)	3 x 6 FIOLAX® ampoules à 20 ml*, with manufacturer certificate
285126528	LF 992	test solution KCl 0.1 mol/l (12.9 mS/cm)	3 x 6 FIOLAX® ampoules à 20 ml*, with manufacturer certificate
285126293	LF 995	test solutions KCl 0.01 / 0.1 / 1 mol/l (1.41 / 12.9 / 112 mS/cm)	3 x 6 FIOLAX® ampoules à 20 ml*, with manufacturer certificate
285126166	LF 1000/Set	same as LF 999/set, in addition platinizing vessel and cable B 1 N	3 x 6 FIOLAX® ampoules à 20 ml*, with manufacturer certificate
285136907	LF 1024	test solution KCl 0.01 mol/l (1.41 mS/cm)	250 ml in PE bottle
285126530	LF CSKC13	test solution KCl 1.3 µS/cm (maximum shelf life: unopened three months, opened six hours)	250 ml in PE bottle
285126540	LF CSKC5	test solution KCl 5.0 µS/cm, (maximum shelf life: six months)	500 ml in PE bottle

ORP electrode solutions

Order No.	Type No.	Redox voltage Pt/Calomel (KCl sat.)	Pt/Ag/AgCl (KCl 3 mol/l)	Contents
285138373	L 4619	180 mV	220 mV	60 FIOLAX® ampoules à 20 ml*, acc. to DIN 38 404-C6
285138357	L 4643	430 mV	470 mV	60 FIOLAX® ampoules à 20 ml*
285138381	L 4660	600 mV	640 mV	60 FIOLAX® ampoules à 20 ml*
285138784	L 4648	180, 430, 600 mV	220, 470, 640 mV	3 x 20 FIOLAX® ampoules à 20 ml*
285138184	L 430	430 mV	470 mV	1,000 ml in DURAN® glass bottle
285138168	L 4304	430 mV	470 mV	250 ml in DURAN® glass bottle

Cleaning solutions for combination electrodes and reference electrodes

Order No.	Type No.	Description	Contents
285138538	L 510	pepsin/hydrochloric acid solution	1,000 ml in DURAN® glass bottle
285138295	L 5104	pepsin/hydrochloric acid solution	250 ml in DURAN® glass bottle

* 20 ml volume = ~17 ml content

7.7 Electrodes - Accessories

Accessories for electrodes

Order No.	Type No.	Description
285126482	NH 928	electrolyte for ammonia electrodes in 50 ml plastic bottle, 3 membrane modules
285126499	NH 995	membrane module set: 3 membrane modules, 3 caps
285215229	TZ 1520	taper adapter NS 14.5 of PTFE for electrodes with Ø 12 mm shaft
285123136	Z 451	measuring and storage vessel with sleeve NS 7.5/16
285123170	Z 453	electrode vessel for storing electrodes with Ø 12 mm shaft
285123152	Z 461	measuring and storage vessel with sleeve NS 14.5/23
285123185	Z 472	watering cap for electrodes with Ø 12 mm shaft



7.8 Connection cables

1 Electrode socket/plug

Coaxial plug for pH, redox, ammonia and sodium combination electrodes, pH and redox single electrodes as well as reference electrodes in Plus series.

Plug L



2 Instrument connector/plug

A (DIN 19 262)



BNC



N Banana



Order No.	Type No.	1 Electrode socket/plug	2 Instrument connector/plug	Cable length and type
285121916	B 1 N	reference electrode plug (B)	Banana plug (N)	1 m single conductor cable
285122456	L 1 A	electrode plug (L)	DIN instrument plug (A)	1 m coax. cable
285122497	L 1 BNC	electrode plug (L)	BNC instrument plug	1 m coax. cable
285122550	L 2 N	electrode plug (L)	Banana plug (N)	2 m coax. cable
285122457	L 1 N	electrode plug (L)	Banana plug (N)	1 m coax. cable
285122489	L 1 NN	electrode plug (L)	2 x banana plug (N)	1 m coax. cable
285122464	L 2 A	electrode plug (L)	DIN instrument plug (A)	2 m coax. cable
285122448	L 2 NN	electrode plug (L)	2 x 4 mm banana plug (N)	2 m coax. cable

Please ask for more plug and cable combinations.

7.9 Tips for successful measurement with pH and ORP electrodes

Chapter 1: How are pH single-rod measuring cells constructed?

Content

Chapter 1: How are pH single-rod measuring cells constructed?	Page 92
Chapter 2: Reference systems of pH electrodes	Page 93
Chapter 3: pH glass electrode types	Page 94
Chapter 4: pH calibration and pH solutions	Page 95
Chapter 5: Accuracy of the pH measurement	Page 96
Chapter 6: Temperature effect - uncertainty in the pH measurement	Page 97
Chapter 7: Acid and alkaline errors in the pH measurement	Page 99
Chapter 8: Diffusion potential as a error source Problem	Page 100
Chapter 9: Care of the pH electrode	Page 101
Chapter 10: Qualifications of the pH measurement	Page 103
Chapter 11: pH measurement in organic media	Page 104

Problem

The users can select from a variety of different electrodes for the pH measurement. When first selecting, the selection is often the problem. It is therefore important to describe the components of the pH electrodes including their features, so that the best electrode can be found for the application.

Question

Which components make up a single-rod pH measuring cell and what functions do they have?

Answer

The basic structure of pH electrodes is very simple: As potentiometric measuring chains, they consist of a measuring electrode and a reference electrode. For many years, it has been the state of the art to integrate both in a shaft as single rod measuring cell. In addition, a large proportion of pH electrodes available on the market today have already an installed tem-

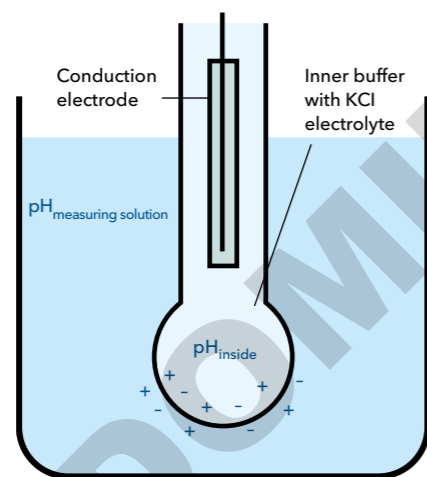

2 The processes on the junction of the 'single-rod measuring'

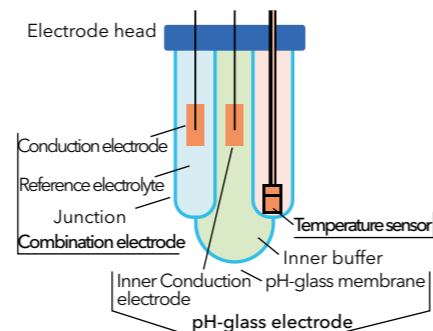

1 Structure of a single rod measuring cell

perature sensor to automatically compensate the temperature dependence of the electrode slope in the pH meter. The construction of such pH-electrodes is described in DIN 19261 and clearly schematically shown in Figure 1.1.

Why does the user need a reference electrode for the pH measurement?

The pH glass electrode is the measuring electrode. The pH signal is generated by it in mV, which is directly proportional to the pH value of the measurement solution. However, the measurement signal can only be measured against a reference electrode, since only differences in potential and therefore voltages can be measured. The reference electrode ideally has a stable, constant potential independent of the pH value and the composition of the medium at all temperatures.

What happens on the glass junction?

The glass junction changes due to the pH value 2. Under the effect of water, alkali ions dissolve from the glass surface and the oxide bridges of the silicate framework partially become OH-groups based on the absorption of water. This is how a "gel layer" devel-

ops. This gel layer acts on hydrogen ions as an ion exchanger.

How does the exchange process work?

In the special pH junction glasses, a reproducible balance develops between the solution and the glass surface, which only depends on the hydrogen ion concentration in the solution and in the gel layer.

Finally, the question remains, how the user recognizes the right choice of the measuring chain: The correct measurement chain provides the highest measurement reliability and longest service life in the application.

Conclusion

Only an electrode matching the application achieves the best measurement reliability and maximum service life. It is especially important to pay attention to the type of junction in the selection of the electrode. This is established by the connection between the electrode and the measuring medium. For example, the platinum junction, which provides a fast and stable measurement setting with its defined electrolyte flow and at the same time protects itself against the penetration of the measurement medium, is generally usable.

Chapter 2: Reference systems of pH electrodes

Problem

Besides glass membranes and junctions, pH-electrodes differ in reference systems and junction types (junction). The desired application makes the choice between pH electrode reference systems and junctions easier.

Question

What is a pH electrode reference system and why do I need it? What kind of reference systems are there for pH electrodes and what features can they provide 3?

Answer

The most common method to obtain a pH measurement is by measuring a voltage. To measure a voltage the pH electrode must be able to measure the difference between two points with different electrical potential values. For a pH electrode to provide a voltage measurement of a solution's ion concentration a reference electrode is necessary because its potential essentially remains constant and independent of the solution and temperature relative to the solution being measured. The pH electrode can then use that reference electrode's potential to determine how the solution's ion concentration compares to the reference.

The voltage developed from this comparison is then turned into the pH measurement.

The Standard Hydrogen Electrode (SHE) is used as the international reference system. Unfortunately due to its complicated handling requirements it is not typically used for standard applications. A common approved reference system is the Saturated calomel Electrode (SCE), however this electrode contains mercury and is toxic. The most common reference system is the silver/silver chloride reference system (Ag/AgCl). However, Ag/AgCl can precipitate silver when exposed to certain samples. An alternate configurations to the standard silver/silver chloride reference system is the double junction construction isolates the Ag/AgCl from the sample by means of a second chamber containing a simple electrolyte solution such as potassium chloride (KCl). A special type of double junction electrode is the Silamid double junction reference system which is a special construction of the Ag/AgCl reference system. Most electrodes having a Ag/AgCl system are built with an Ag wire coated with AgCl. Silamid reference systems have a glass tube with the inner part coated with Ag,

Reference System	Advantage	Disadvantage
Ag/AgCl	Well described, multifunctional, reproducible, wide temperature range, nontoxic → environmental sustainability	Reference potential depends on temperature and could deliver a different potential, if measured at a different temperature as calibrated
Hg/Hg ₂ Cl ₂ (Calomel)	Stable reference potential	Toxic, low temperature application range 59 to 104 °F (15 to 40 °C)
Tl,Hg/TlCl (Thalamide)	very low hysteresis, broad temperature range, low temperature coefficient	toxic, out of production
Iodine/Iodide	Low polarization, low temperature dependence, free of undesired heavy metal ions	formerly limited long-life-cycle

table ▲ : Advantages and disadvantages of different reference systems

Chapter 3: pH glass electrode types

then filled with AgCl, and plugged with a polyester fibre. This reference system creates greater contact surface area between Ag and AgCl compared to the standard Ag/AgCl wire system. This results in a reference system that is long lasting and very stable. A more recent reference system is the iodine/iodide system. The iodine/iodide reference system does not precipitate silver and can be used with Tris buffers. The advantages and disadvantages of different reference systems are displayed in table 3. Further characteristics of the reference electrode are defined by the junction.

Conclusion

The most important pH electrode reference system is the Ag/AgCl system because it is well described, reproducible, and nontoxic. In the few applications where this reference system does have problems the newer iodine/iodide reference system can be used instead. Due to an absence of silver ions or other contaminating metal ions the iodine/iodide reference system is an excellent alternative when working with applications requiring rapidly changing temperatures. Even with quick changing pH values such as titrations, the iodine/iodide reference system is beneficial.

Problem

There are many different pH glass electrodes on the market. Each pH glass electrode has particular qualities so they should be chosen carefully to suit the measurement application.

Question

What different kinds of pH glass electrodes are available? What are the main characteristics of these electrodes and which membrane glass is recommended for which measurement application?

Answer

Over time the glass membrane of a pH glass electrode changes due to the process of taking pH measurements. Because of exposure to water, alkali ions dissolve from the glass surface and oxide groups of the silicate become OH groups which causes a source layer. This source layer appears to hydrogen ions as an ion exchanger. Using a special pH glass electrode membrane there is a reproducible balance between the sample solution and glass surface, which is only dependent on the hydrogen ion concentration in the solution and the source layer 4.

Because pH glass electrodes have numerous different capabilities many different kinds of membrane glasses

are needed to make accurate and reliable pH measurements for all applications. SI Analytics offers five different types: L-, H-, S-, A- and N-glass. The main characteristics of these pH glasses are:

- ▶ L: Wide application range, very low impedance resulting in accurate and rapid response times over a large temperature range 3
- ▶ H: Optimized for higher temperatures up to 275°F (135°C) and extreme pH-values, high accuracy in stronger alkaline range (Na⁺)
- ▶ S: Tolerates sudden temperature changes, provides constant measurement values with fast response time in hot alkali solutions
- ▶ A: Fast response time in drinking water, surface water, sewage, and general applications
- ▶ N: At normal temperatures usable for the full pH-range and almost all kinds of samples.

The following examples illustrate the use of different pH glass electrodes: With a strong alkaline media the so called "alkaline measuring error" appears. This error is triggered by the confusion of sodium with hydrogen ions (cross sensitivity) and causes a measurement inaccuracy beginning at a pH value of 12 in

3 Blue pH glass bulb of a pH electrode



Chapter 4: pH calibration and pH solutions

presence of sodium ions. Under extreme conditions this inaccuracy could mean a difference up to 1 pH unit. In those cases the H type glass electrode should be used.

Applications with hot alkaline treatments or sterilization by superheated steam impose great demands on the consistency of the membrane glass. Under these conditions a pH glass electrode usually ages faster and corrodes. In this case the right choice would be a S type pH glass electrode.

In common applications or drinking water measurements the challenge is the variety of applications and the low conductivity of the pH glass electrodes. This could lead to slow response times and unstable or unreliable data. For these demands the A type glass has been developed. It features rapid response times and extended use.

Conclusion

The characteristics of the membrane glass determine the quality of the characteristics of the pH glass electrodes. Only the right choice of pH glass electrode will provide you with the highest accuracy and reliability.

Problem

To calibrate pH measuring systems you must use a solution with a known pH value, also known as pH reference or buffer pH solution. The accuracy of your subsequent pH measurements is dependent on how accurately the pH measuring system is calibrated, so particular attention must be paid to this step. Because there are a great number of different buffer pH solutions available many people are uncertain about how many and what pH calibration solutions should be used.

Question

What is a buffer pH solution and how many pH calibration points are reasonable?

Answer

A buffer pH solution is composed of either a weak acid and the conjugated base or a weak base and the conjugated acid. The main characteristic of a buffer pH calibration solution is that the pH value of the solution will not alter when a small amount of acid or a base is added. Dependant to the used components and their concentration the pH value of the buffer solution can be set over nearly the complete pH range, e.g. with HCl and sodium citrate (pH 1-5), citric acid and sodium citrate (2.5-5.6), acetic acid and sodium acetate (3.7-5.6), Na₂HPO₄ and NaH₂HPO₄ (6-9) or borax sodium hydroxide (9.2-11). The pH value of the calibration solution does not only alter with its composition but with temperature changes. An exact specification of refer

ence pH calibration solutions is given by the DIN 19266. The thermal characteristics of these buffer pH calibration solutions have been determined by metrological institutes 5 (see Table 4).

In contrast to reference pH calibration solutions the composition of technical buffer pH solutions is not regulated. So it is important to note that the temperature reaction of those pH calibration solutions can be manufacturer-specific, even if the same nominal pH value is specified at 25 °C. In particular at a calibration temperature other than 25 °C considerable errors can occur with the pH measurement results. In addition to different kinds of buffer pH solutions the calibration procedure plays a major role in determining the accuracy of the pH measurement. The following pH calibration procedures are described in detail in DIN 19288.

- ▶ One-point-calibration: A one-point-calibration is accomplished using one reference pH calibration solution. Here only the zero point of the pH electrode is verified and it is assumed that its slope is close to theoretical Nernst slope. This method of pH electrode calibration is the fastest. It is recommended to use this calibration method for comparative only and not for absolute measurements.
- ▶ Two-point-calibration: This method is accomplished using two reference pH calibration solutions, with a minimum pH difference of two units. Here the maximum measurable pH value and zero point of the pH electrode are determined by a linear slope cutting through the measuring points (in the application of the measured mV against the nominal pH value of the buffer solution).

Table 4: Temperature behavior of reference pH buffer

Temperature in °C	pH		
10	3,997	6,923	9,332
20	4,001	6,881	9,225
25	4,005	6,865	9,180
40	4,027	6,838	9,068
50	4,050	6,833	9,011

Chapter 5: Accuracy of the pH measurement

▲ **Multipoint-calibration:** A multipoint calibration is accomplished with three or more reference pH calibration solutions. The difference between pH solutions should be greater than 0.5 pH units. The pH electrode calibration curve is determined by either linear regression through all measuring points or built from segments between neighbored buffers in which the zero point and slope can be calculated. To evaluate the certainty of the calibration procedure the stability index (R2) could be consulted. It shows whether the theory correlates with the results and should have a value around 1. Often alkaline buffer solutions are used to accomplish a multipoint calibration. These should be checked for freshness and percentage error effect has to be estimated.

Generally a two-point-calibration with DIN buffer pH calibration solutions 4.01 and 6.87 is sufficient, because they are very stable. Furthermore pH electrodes offer due to their high linearity a sufficient measuring security beyond the pH values of the used buffers. Even for additional coverage the two-point-calibration can be checked through an additional measuring of a buffer solution within the range of the estimated pH value.

Conclusion

The higher the required accuracy of the pH measurement, the higher the need for DIN-19266 buffer pH calibration solutions, which provide an accuracy of under 0.01 pH. Multipoint-calibrations should increase the accuracy and for most pH measurement applications a two-point-calibration will be satisfactory.

Problem

The question of the accuracy of pH measurement is not easy to answer because there are many factors that are often not or not precisely known to even the experts. However, one thing is certain: The pH value shown on the pH meter says nothing about its accuracy. The number of decimals is always deceptive in showing an excessively high accuracy.

Question

What are the key factors and how can the accuracy be determined?

Answer

In metrology, the uncertainty is likely selected as a standard for the measurement accuracy. The lower the uncertainty, the higher the measurement accuracy. This uncertainty is a part of every measured value. It is composed of the uncertainties of the individual contributions to the measured value. This difficult subject for the pH measurement is presented easily understandable for the user in standard DIN 19268 [6]. The important temperature effect is disregarded in the standard for the sake of simplicity, and adhering to the temperature constant is assumed. The following, however, must still be included:

Table 5.1: Examples for measurement inaccuracies

Calculation in accordance with DIN 19268		Expanded inaccuracy ± U (k=2)		
Measured value	value	Case 1	Case 2	Case 3
Puffer1	4.008	0.01	0.02	0.02
Puffer2	6.865	0.01	0.02	0.02
Measurement voltage 1 [mV]	174.6	0.2	0.2	2
Measurement voltage 2 [mV]	6.6	0.2	0.2	2
Measurement voltage x [mV]	-1.4	0.2	0.4	3
Measurement voltage x [pH]	7.001	0.023	0.045	0.131

▲ pH of the buffer solutions with uncertainty,

▲ Uncertainty of the measured values in buffer solutions and

▲ Uncertainty of the measured value in the sample solution.

In order to ensure a high measurement accuracy for the calibration, buffer solutions according to DIN 19266 are recommended, in which various manufacturers already specified the measurement uncertainty.

Now the question arises as to the uncertainty of the measurement values in these buffer solutions during calibration or adjusting. A dissolution of ±1 digit is assumed for the pH meter. This corresponds to 0.2 mV or 2 mV (depending on the dissolution of the pH meter and its digital display). Then the question of the uncertainty of the pH measuring chain voltage remains. Assuming that the pH glass electrode operates linearly up to pH < 12 prior to insertion of the "alkaline error", the reference electrode with the junction and the interference potential, the liquid junction potential (LJPs) remain as a critical point. The LJPs in buffer solutions according to DIN 19266 in reference/bridge electrolyte amount to about -2.5 mV at 3-4 mol/L KCl. If the mea-

Chapter 6: Temperature effect - uncertainty in the pH measurement

Problem

Varying temperatures affect the measurement of the pH value. These must therefore be included in the uncertainty of the measurement.

Question

What effect does the temperature have in the pH measurement? What are isotherms? How does the temperature compensation work? How does the pH value of buffer solution and the sample change with the temperature?

Answer

The voltage of the pH combination electrode changes with the temperature. This behavior can be described by the Nernst equation:

$$U = U_{0+} + (R \times T / n \times F) \times \ln a_{H^+}$$

- ▲ a_{H^+} : Activity of the hydrogen ion
- ▲ U_{0+} : Standard potential
- ▲ R: Gas constant 8.3144 J/K*mol
- ▲ T: Temperature
- ▲ F: Faraday constant $9,6485 \times 10^4$ C/mol
- ▲ n: Number of electrons transferred

The Nernst factor ($R \times T / n \times F$) indicates the theoretical slope of the electrode. This factor is temperature dependent, it varies between 54.20 mV/pH at 0 °C and 74.04 mV/pH at 100 °C.

In real electrodes, the slope never exactly corresponds to the Nernst factor. In addition, the zero point of the measurement chain, especially in heavily aged electrodes, is temperature dependent. When recording the voltage of a real electrode at two different temperatures at different pH

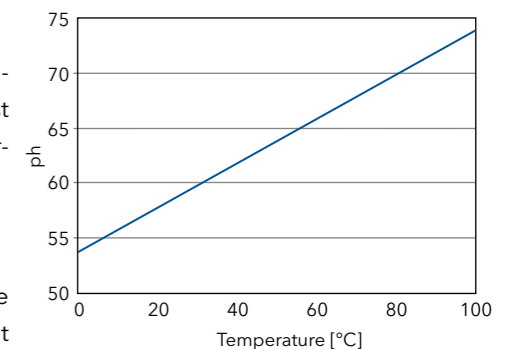

4 Temperature dependency of the Nernst factor [3]

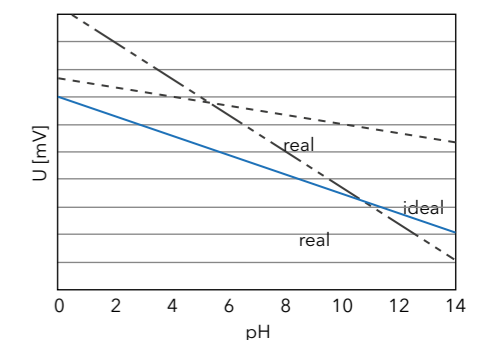

5 Characteristics of a real and an ideal electrode

values, a characteristic curve is obtained for each temperature. These characteristics, called isotherms, intersect in the isothermal intersection. This intersection can vary markedly from the zero point of the ideal characteristic [5]. When conducting measurements at many variable temperatures, you can even receive a field of isotherm intersections [2].

The temperature compensation of pH meters only takes into account the change of the theoretical slope in temperature changes. When calibrating the metering device at a certain temperature and measures at another temperature as the calibration temperature, the temperature compensation adjusts the slope according to the theoretical slope.

Chapter 7: Acid and alkaline errors in the pH measurement

oretical change of the Nernst factor. Non-ideal behavior of the slope and the zero point is not recorded here. This plays a minor role for less critical applications. However, in measurements with far deviating temperatures that required maximum accuracy, the measuring chain must be calibrated for each measuring temperature with buffers at the same temperature..

The temperature responses for buffer solutions were precisely studied by metrological institutes. DIN buffer solutions are precisely specified by DIN 19266. These buffers show a temperature behavior such as shown in Table 4.5.

Technical buffers display a different temperature behavior than DIN buffer solutions, and their compositions are not defined, i.e. each manufacturer can produce his own mixture. Incorrect measurements can result here due to the lack of knowledge of the temperature responses of the buffer solutions.

The specific temperature dependence of the hydrogen ion activity of the sample is almost never known and therefore can neither be compensated nor be converted to a reference temperature as at the conductivity measurement. Hence it is mandatory to note the temperature at which the pH value has been deter-

mined. A comparison of the pH values of the same sample at different temperatures is nearly impossible. This frequently results in great variations between operational pH measurements at elevated temperatures and the measurement of the sample in the laboratory at room temperature.

Conclusion

The electrode zero point and slope, in practice, can have deviations from the ideal behavior, which is described by the Nernst equation. The greater the difference in the temperature between the calibration and measurement, the greater the measurement deviations. Deviations from 0.05 to 0.25 pH are possible, depending on the difference between the calibration temperature and the measurement temperature 4.5.

The calibration and measurement should be performed at the same temperature for a possibly precise measurement. Based on the more precise specification, buffer solutions according to DIN 19266 should be applied for the calibration.

In order to evaluate the measurement results and for a complete documentation, the measurement temperature, the electrode used and the calibration conditions must always be

specified with the result of the pH measurement. A conversion of the pH value of a sample from the measured temperature to another temperature is not possible.

Temperature in °C	pH	
10	3.997	6.923 9.332
20	4.001	6.881 9.225
25	4.005	6.865 9.180
40	4.027	6.838 9.068
50	4.050	6.833 9.011

Table 4.5: Temperature behavior of various DIN 19266 buffer solutions

Problem

What effects can occur during measurements in solutions with extreme pH values?

Question

What are acid and alkali errors? Under what conditions do they occur? What impact do they have?

Answer

Even measuring chains, which respond ideally over a wide pH range, i.e. linear, can display deviations in the very acidic (< pH 2) or basic (> pH 12) range 6.2.

The effect of these deviations is that too high pH values are displayed in the acid medium and too low pH values in an alkaline medium. In the first case, the acid error is stated and in the second case, the alkali error.

The acid error is generally lower than the alkali error. One cause of the acid error is the incorporation of acid molecules in the gel layer or the change of water activity, resulting in reduction of the H⁺ ion activity 2. It is only observed under very extreme conditions in practice. In addition, high concentrations of acids dehydrate the source layer by osmotic pressure and accumulate the hydroxyl groups. Both results in apparently higher pH

values 7.

The alkali error is much more relevant to the reliability of the measurement. It occurs when the measuring solution contains alkali ions (e.g. lithium or sodium) and has a pH value of greater than 12. Under these conditions, there is an exchange of alkali ions in the gel layer of the membrane glass and in the measuring solution. This cross sensitivity is also known as sodium error, since a sodium hydrozide solution is frequently used for setting very high pH values 3. Figuratively speaking, the alkali metal ions are detected in addition to the H⁺ ions, simulating a lower pH value. Depending on the type of pH membrane glass, the pH value of the measurement solution, the temperature and the alkali ion concentration, the alkali error can amount up to one pH unit.

The alkaline error is slight in modern pH glasses. Results from the measurement of pH electrodes with various pH membrane glasses are compared in table 4.6. The measurements were each made in solutions of the same pH value (once with sodium ions and once without). The concentration of sodium ions equaled 1 mol/l. In order to obtain the maximum accuracy, a pH glass that possibly has a slight alkali error should be noted at this

	pH value without sodium ions	pH value with sodium ions	Alkali error
Electrode 1	13,72	13,15	0,57
Electrode 2	13,77	13,45	0,32
Electrode 3	13,98	13,63	0,35
Electrode 4	13,78	13,21	0,57
Electrode 5	13,80	13,25	0,55

Table 4.6: Measurements with different membrane glasses in a solution with pH 14 without and with an addition of sodium ions (concentration 1 mol/l).

high pH value and high concentration of sodium ions.

Conclusion

In order to achieve the highest possible accuracy of pH measurements, even under extreme conditions, the electrode should be selected to suit the application. At high alkali concentrations and high pH values, a pH electrode with a minimum of alkali errors should be selected.

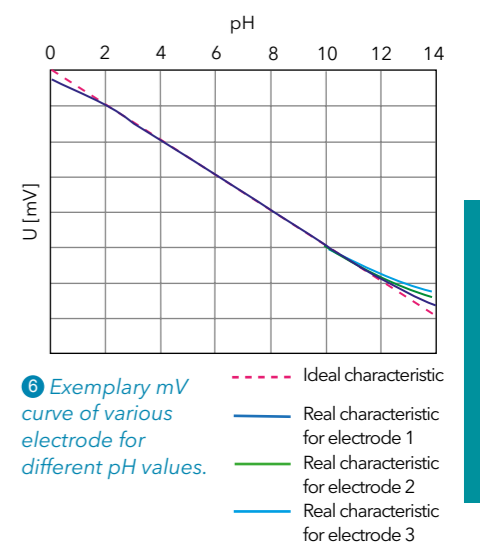

Chapter 8: Diffusion potential as a error source

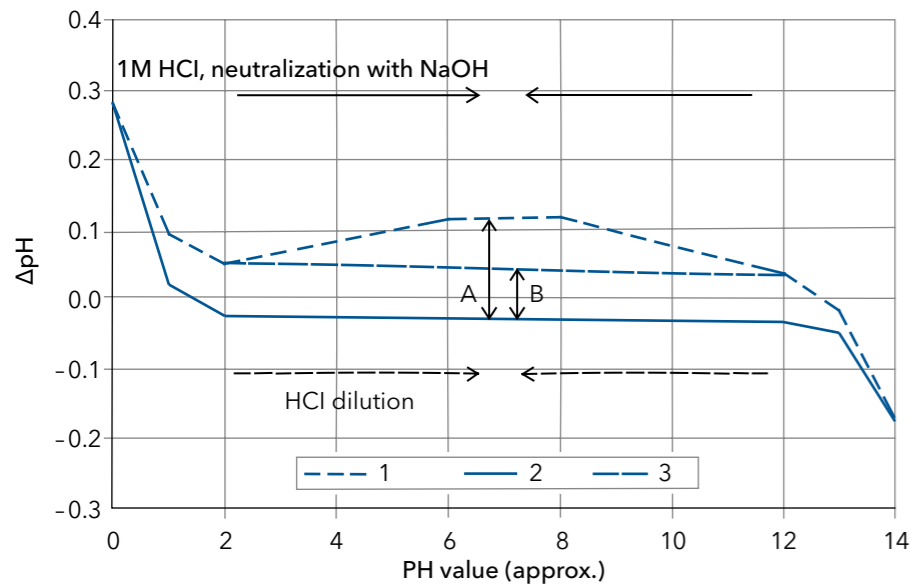

7 Course of the measurement error of a pH electrode

Problem

Diffusion potentials are often referred to as a disturbance variable in the pH measurement. However, their size and influence on the measurement accuracy are rarely known. Diffusion potentials were calculated for several examples and compared with practical measurements. In simple systems, the calculations were confirmed [8, 9].

Question

How great can diffusion potentials be and how do they affect the accuracy?

Answer

The Henderson equation is usually applied for calculating the diffusion potentials. This requires that concentration, the mobility and the charge of all the ions involved in a sample are known. This means that if only one parameter is unknown, the calculation cannot be performed. In most

solutions, however, even the composition is not precisely known. A number of assumptions must therefore be applied when calculating the diffusion potentials, which then results in a rough estimate of the expected measurement errors. Therefore, the following deliberations must be applied:

As a reference or bridge electrolyte, a three molar KCl solution is usually used. It should also be the basis for the calculation of the diffusion potentials according to Henderson.

The size of the diffusion potentials is essentially determined by the differences in the mobility of all the types of ions. Therefore, the contact with hydrochloric acid and caustic soda is therefore observed here regarded as an adverse event.

Since errors in the pH measurement must be considered here, the calculated diffusion voltages are converted into ΔpH at 25 °C and presented

against the pH value of the solution (7). The change of the pH values must again be achieved by a dilution (7 1) with water and once by neutralization (7 2). The figure shows the calculated variations in measurements ΔpH versus the pH value of the solutions for the mentioned cases. The following areas must be considered:

- ▲ Errors can greatly increase in extreme pH values.
- ▲ Extremely high values are measured in the acid range and extremely low values in the alkaline range.
- ▲ The error increases at great dilutions (purest water A). If the ion strength is higher, for example at a conductivity greater than 1 mS/cm, the measurement errors from diffusion potentials are lower (3,B).

Conclusion

In solutions with conductivities greater 1 mS/cm and in the range of $2 < \text{pH} < 12$, the effect of diffusion potentials on the uncertainty of the pH measurement is approximately $\Delta\text{pH} < 0.05$. In the estimation of the measurement uncertainty, however, any additional sources of errors must be taken into account.

Chapter 9: Care of the pH electrode

- ▲ What is the consistency of the measurement solution? It makes a difference, for example, whether a puncture measurement or a measurement is performed in the solution.
- ▲ Are sulfide, bromide, iodide or other unwanted electrode poisons present within the solution? The reactions in the electrode can be avoided by the selection of the reference system and the junction.
- ▲ Is the measurement performed in aggressive compounds (such as HF or hot sodium hydroxide solution)? This information helps in the selection of the shaft material and the membrane glass.

Once these issues have been resolved, the design requirements for the electrode must be determined:

- ▲ Which installation length and diameter is required? This information is required when e.g. measuring in special vessels.
- ▲ What accuracy of the electrode is necessary, which strength is required? This information is important to decide whether a gel electrode with a plastic shaft or a liquid electrolyte electrode with a glass body is used.
- ▲ Will a temperature sensor be integrated in the electrode or not? What connections does the measuring device have for the electrode? This is important, in order to provide the appropriate connection of the electrode to the measuring device.

- ▲ Is the application area of the pH measurement in the laboratory or process? When the electrode is used in the process, it is important to clarify what pressure is applied in the measurement and how the electrode is installed. When used in the process, the electrodes have a special built-in Pg13.5 thread to be permanently installed at the measuring station via a holder. If liquid electrolyte electrodes are used under such conditions, a pressurization of the electrolyte storage must also be provided.

Conclusion

When selecting the electrode, it is important to coordinate it to the respective application. The user can only then assume an optimal service life and accuracy of the measurement.

Problem

How do pH electrodes have to be maintained/cared for and stored?

Question

What influence does the maintenance and care have on the service life of the electrode and the accuracy of the measurement? How should the electrode be stored? What cleaning methods are there?

Answer

Careful handling and storage of the electrodes are elementary for reliable results. Furthermore, the durability is thereby increased. The following tips show an overview [10, 2, 3]:

- ▲ Storage: An electrode should never be stored dry, but always in watering solution. The watering cap should be filled with the following solutions depending on the type of electrode:
 - Single-rod measuring cells and reference electrodes: In case of liquid electrolyte electrodes, the electrolyte solution in the reference electrode should also be used for watering. 3 mol/l KCl solution must be used in gel electrodes.
 - Glass electrodes: In case of pure measurement electrodes, the watering cap can be filled with deionized water. For single-rod measuring cells and reference electrodes, this results in a reduction of the service life.
- If the electrode has been stored incorrectly dry, it must be watered for at least 24 h in the above solutions

Chapter 10: Qualifications of the pH measurement

before its first use. The functionality must be tested by calibrating prior to the measurement.

▶ **Cleaning:**
Dirt deposits of any kind on the membrane surface or the junction may result in the reduction of the service life of the electrode and inaccurate measurements. The electrode should preferably be chemically and not mechanically cleaned. In the event of dirt deposits outside the electrode and the junction, the following cleaning processes can be performed:

- **Inorganic adhesions:** Put the electrode for a couple of minutes into 0.1 mol/l HCl or 0.1 mol/l NaOH. If the buildup is not resolved, the solution should be cautiously heated up to 50 °C before the acid or alkali concentration are increased.
- **Organic adhesions:** Rinse the electrode with organic solvents. The membrane can be carefully and briefly wiped with a damp, lint-free, soft cloth. The resistance of the plastic shaft of the electrode to organic solvents should be noted in this treatment.
- **Proteins:** Placing the electrode in a pepsin/HCl solution for at least 1 h.
- **Sulfides on the ceramic junction:** Store the electrode in a thiourea/HCl solution (7.5 % in 0.1 mol/l HCl) until the discoloration on the junction has disappeared. After cleaning, the electrode is rinsed with deionized water and placed in the electrolyte solution for at least 1 h. In addition, the electrode must be recalibrated prior to the next measurement.

▶ **Cleaning of the reference electrode with liquid electrolyte:**

- In case of dirt/particles in the reference electrode: remove the old and refill with new electrolyte. If necessary, repeat until the dirt is removed. Some heated electrolyte (about 45 °C) can also be used. An internal chemical cleaning is not advised, since the reference system can be irreversibly damaged.
- KCl crystals in the interior: The crystals can be dissolved when heating the electrode in a water bath at 45 °C. Then the electrolyte must be completely replaced.

▶ **General treatment recommendations:**

- After the measurement, the electrode must be rinsed immediately with deionized/distilled water and stored in the recommended manner.
- The electrode is regularly inspected for dirt deposits on the membrane surface, the junction and the interior.
- Measurements in aggressive and/or hot media result in a reduction of the service life.
- When using electrodes with liquid electrolyte, the filling opening must be opened during the measurement/calibration, in order to prevent a back diffusion of the sample by the electrolyte flow. The refilling opening must be closed when storing and between the measurements.
- The use of deionized water as a storage solution for any electrode reduces their service life.
- Never store the electrode dry, use it as an agitator or clean it mechanically.

Conclusion

The general treatment recommendations contribute greatly to the service life extension of the electrode and thus to the accuracy of the measurement.

Problem

pH measurements are operated in GMP/GLP-related companies for quality control of both raw materials and finished products. The measured pH values therefore are highly relevant in determining whether the sample meets the requirements or not. Accordingly, measures must be taken to ensure the accuracy of the measurement.

Question

What measures are available to ensure the pH measurement, and how are they performed?

Answer

The qualification process consists of up to four consecutive test stages 9. They include the following steps that must be documented accordingly:

- ▶ **DQ (Design Qualification):** The user formulates the requirements for the components and operating conditions in the DQ prior to purchasing. Described are the purpose of use, environmental conditions, technical data, a description of the samples, as well as general and special requirements based on the application 11. The DQ is therefore the documented evidence that the instrument is designed and manufactured in accordance with the requirements and the user receives exactly what he needs.

- ▶ **IQ (Installation Qualification):** The IQ is conducted at the site of the installation. The completeness of the system and the environmental and application con-

ditions are examined after delivery. The IQ provides evidence that the delivered instrument meets the specifications of the order (DQ), is properly set up at the intended work area and is properly installed for the environmental conditions there. A first test can already be included in the IQ. After this training, the system is ready for use.

- ▶ **OQ (Operational Qualification):** The OQ is used to check whether the installed system complies with the general conditions of the technical and functional specifications. The test includes a test of the device at the point of use. A comparison with the technical data of the components or a test with a standard can be performed, which can be attributed to a national standard. For a pH measuring system, this means the determination of the pH value of DIN buffer solutions after the calibration of the device.

- ▶ **PQ (Performance Qualification):** The PQ is used to demonstrate that the measurement system consistently provides a performance according to specifications under real operating con-

ditions. During the IQ and OQ, which must be carried out once, which the suppliers often offer in the form of prefabricated documents up to the implementation of the qualifications, the PQ is usually performed by the user on a regular basis. The testing interval is determined according to the application of the measurement system 12.

Conclusion

The individual tests of the pH meter and electrode yield only a statement about the current functioning of the electrode and the pH meter as individual components, but no statement about the continuous validity of pH measurements of the entire system. The qualification beginning from the design qualification prior to the purchase, over the one-time installation (IQ) and Operational Qualification (OQ) at the corresponding work station up to the routine performance qualification (PQ) together provide verification that the complete measuring system (consisting of pH meter, pH electrode, buffer solutions) yield a consistent performance according to specifications under the specific conditions.

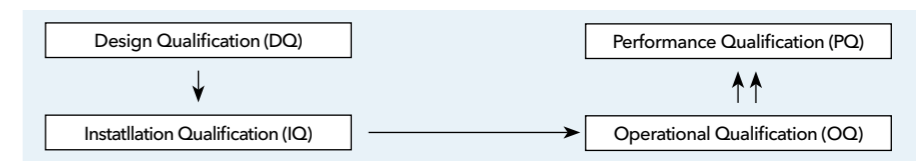

Fig.. 9

11

Chapter 11

pH measurement in organic media

Problem

The requirements for the feasibility and accuracy of pH measurements and titrations in nonaqueous media for process and quality control increase steadily in the pharmaceutical industry.

It is therefore important to examine to what extent one can speak at all of a classic pH-measurement in such analyses and how the electrodes respond in such a medium.

Question

Under what conditions are pH measurements and titrations possible in non-aqueous media?

Answer

The pH value in accordance with DIN 19260 [13](#) is only defined in aqueous media. However, analog to the dissociation of the water:

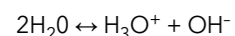

similar observations for aqueous solvents can be employed and the following equation can be employed:

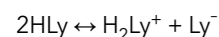

H_2Ly^+ is the protonated solvent molecule and is called Lyonium ion. Ly^- is the deprotonated solvent molecule and is called Lyat ion. Aprotic solvents such as DMSO or benzene do not dissociate from the equation. Only water-like solvents with a dissociation such as Ethanol allow the introduction of a pH scale. This results from the pK_L value of the solvent. Thus, the scale for water contains 14 units, 16.7 for methanol and 19.1 for ethanol.

With the creation of individual, that is

solvent-dependent, pH scales, however, only the first step is accomplished. It requires then also individual reference buffer solutions to calibrate the electrode under these conditions. If the pH electrode is calibrated with aqueous buffer solutions and a pH measurement is then performed in an aqueous medium, this corresponds to the proverbial comparison of apples and oranges. The absence of reference buffer solutions based on the particular solvent may therefore not be followed with a conversion of the actual measured value mV, as delivered by pH-electrodes, into a pH-value.

In contrast to the pH measurement, the absolute pH value is not the relevant value for titrations, but the change of pH value. The consumption of titrant up to this pH jump is applied for the content calculation. Under such conditions, the conversion of the original mV measured value of the electrode into a pH-value is possible, but this conversion value is just as little reliable as an absolute measurement value.

In addition to the lack of individual reference buffer solutions and the associated lack of knowledge of the hydrogen ion activity in non-aqueous solvents, the challenge for the pH measurement in such samples, among others, is subject to the following two phenomena:

- The increased phase boundary voltage on the junction upon contact of the non-aqueous solvent with the reference electrolyte of the electrode complicates the pH measurement [14](#).
- The low conductivities of these solvents also result in problems. The effect of low conductivity is shown in

very fluctuating measured values even at pH measurements in distilled water. Organic solvents even increase that effect.

The electrodes or their membrane should be conditioned or formed to the proper solvent even for recording the mV value. With immersing the electrode into the solvent the resistance of the glass membrane is reduced and a faster response time of the electrode is guaranteed [3](#).

Conclusion

No measurements to determine the absolute pH value in non-aqueous solvents (i.e., having a water content of less than 30%) may be carried out, but only direct mV measurements.

With an increased setting period in these media, a pretreatment or formation of the electrode may also be anticipated [15](#).

References

- [1](#) DIN 19261, Beuth
- [2](#) M. Huber, Wissenswertes über die pH-Messung, SCHOTT Geräte, 1989
- [3](#) H. Galster, pH-Messung, VCH, 1990
- [4](#) J. Falbe und M. Regitz (Hrsg.), Römpp-Chemie-Lexikon, 9. Auflage, Thieme, 1990
- [5](#) DIN 19266, Referenzpufferlösungen zur Kalibrierung von pH-Messeinrichtungen, Beuth, 2000
- [6](#) DIN 19268, pH-Messung - pH-Messung von wässrigen Lösungen mit pH-Messketten mit pH-Glaselektroden und Abschätzung der Messunsicherheit, Beuth, 2007
- [7](#) pH Fibel, WTW, 2000
- [8](#) G. Milazzo, Elektrochemie, Springer-Verlag, 1952
- [9](#) G. Tauber, Industrial pH Measurement - Contribution of Diffusion Potentials to Measurement Uncertainty, in: tm-Technisches Messen, Oldenbourg Wissenschaftsverlag, 6/2009, 306ff
- [10](#) <http://www.si-analytics.com/downloads/produkt-und-anwendungsinformationen/laborelektroden>
- [11](#) <http://www.validation-online.net/user-requirements-specification.html>
- [12](#) <http://www.fda.com/csv/index.html>
- [13](#) DIN 19260 - pH Messungen Allgemeine Begriffe, Beuth
- [14](#) T. Mussini, A. K. Covington, P. Longhi und S. Rondinini, Criteria for Standardization of pH Measurements in Organic Solvents and Water + Organic Solvent Mixtures of Moderate to High Permittivities, in: Pure & Applied Chemistry 57, No. 6, 1985, 865ff
- [15](#) H. Becker, I. Sound (SI Analytics GmbH) : Grenzen der pH-Messung in nichtwässrigen Lösungsmitteln, in: LABORPRACTIX 11/2007, 44ff



More SI Analytics Products

pH measurement

Perfectly matching measurement systems

Benchtop and handheld meters

We offer several product lines for a wide range of applications. From the beginner class to the digital multi-channel device you get everything from a single source.

For example



Electrodes

Laboratory electrodes

Suitable for our versatile devices, we offer countless types of electrodes for almost every application. These electrodes are still produced by hand at our location in Mainz in order to ensure the best possible quality and a long shelf life and precise measurement.

Example electrodes



Spectrometry

UviLine SI Spectrophotometers

Our spectrometers **UviLine SI 5000, 6000 and 7000** are state-of-the-art single beam photometer at VIS or UV-VIS range with excellent price performance ratio. Various accessories (cuvette holder and changer, sipper) can be added for demanding applications.

The product range is completed by the reference beam Spectrophotometers **UviLine SI 6100 and 7100** featuring a reference beam and a bigger color screen in addition to the same technical specs as UviLine 6000 and 7000.

UviLine SI 7100



AVS® | ViscoSystem® | Viscometers

Precise capillary viscometry - Innovation from the outset

The **ViscoSystem® AVS® 370** (PC controlled) and the **ViscoSystem® AVS® 470** (as stand alone solution) offer the extraordinary combination of both „pressure“ or „suction“ in operation. This gives you more flexibility and better adjustment to the liquids to be examined. It enables the operation of a Visco Pump II module for optical detection of transparent samples or the TC version for opaque and black fluids.



ViscoClock plus

Measuring perfection

The ViscoClock *plus* is an electronic timing unit for glass capillary viscometers used to determine kinematic and relative viscosity. Succeeding the well-proven ViscoClock, the new instrument features data storage and simpler handling. The ViscoClock *plus* is especially designed for Ubbelohde type viscometers which are well-known for highest precision.

Improved measuring viscosity automatically

The sampling machine AVS Pro III is a fully automatic viscometry measuring station. Even with the high throughput of samples, this station convinces with excellent accuracy and reproducibility - whether operating during the day or unattended during night.

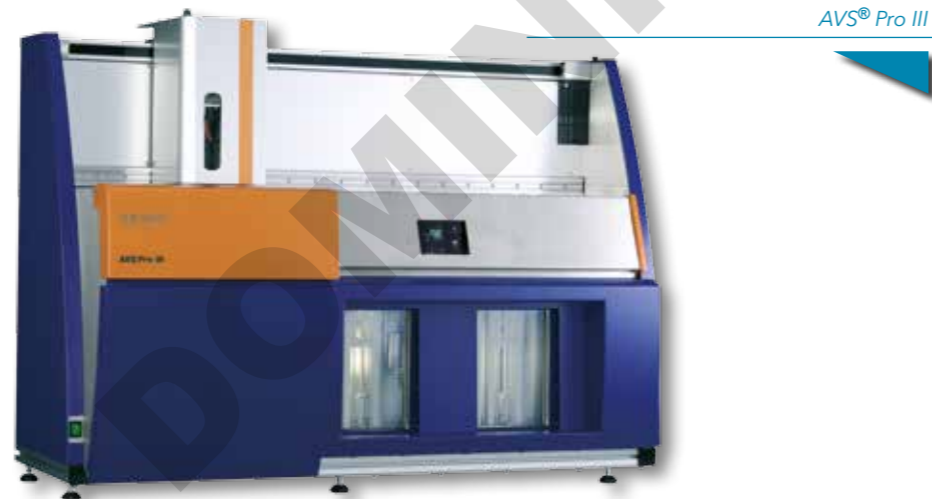

AVS® Pro III

Process Technology

Process electrodes, armatures and accessories

The reliable measuring of pH, ORP, conductivity and D.O. values at extreme process temperatures require individual solutions. Our extensive range of process electrodes includes all applications for measurements in aqueous solutions in the temperature range from -30 °C to 140 °C at a pressure up to 12 bar. Furthermore, many of our electrodes are registered according to the ATEX guidelines 94/9/EG. The retractable holders and their control system enables flexible measurement with an ideal positioning of the electrode in the medium.



SteamLine Electrode



CHEMtrac 810

Hotplates and Stirrers

The laboratory hotplates from SI Analytics have the benefits of the glass-ceramic heating surface which has proven by millions in households. Chemical resistance, a high-grade surface quality and a resistance to temperature shock of more than 700 °C provide the user maximum benefits compared to conventional hot plate materials. The always plane and pore-free surface enables even most stubborn dirt to be removed.



Stirrer SLR

Only a brief excerpt from our company's history

Since 1936 - consistently new products from research and development

- 1936 Development and production of pH glass electrodes at Jenaer Glaswerk SCHOTT® & Gen. in Jena.
- 1940 Beginning of viscometer production using capillaries that were manufactured in accordance with the calibrated precision glass method that SCHOTT® had developed.
- 1952 Development and production of the first gel-filled, low-maintenance reference electrodes.
- 1962 The unique platinum diaphragm makes substantially faster response times possible, among other things.
- 1964 Double electrolyte system for reference electrodes.
- 1970 Introduction of semiconductor preamplifiers for pH measurement technology.
- 1972 Buffer solutions in double-pointed ampules sterilized with superheated steam guarantee reliable calibration - even after several years in storage.
 - S6 and S7 plug system from SCHOTT®, copied time and again.
- 1973 SCHOTT® Geräte GmbH established as an independent company.
 - Beginning of viscometer calibration using PTB tested reference measurement standards. (German Physical Technical Institute).
- 1974 Development and production of electronic laboratory pH meters.
- 1975 Market launch of the first automatic viscosity measurement apparatus for aggressive and corrosive solvents (AVS®/G and AVS®/PA).
- 1977 Development and production of portable electronic pH meters.
- 1978 The first titration control unit TR 155 and the T 100 piston burette with interchange unit.
- 1982 The first microprocessor-controlled viscosity measurement apparatus (AVS® 300).
- 1983 Development of the new Type S pH glass for hot alkaline solutions with extraordinarily high reliability and useful life, and Type H pH glass, robust and minimal alkali error.
- 1984 Combination measurement and reference pH electrode with integrated Pt 1000 as temperature sensor.
 - SCHOTT® Geräte presents the first thermal scanning method for viscosity measurement.
 - The first stand-alone viscosity measurement apparatus with integrated computing function (AVS® 400 and AVS® 440) are introduced to the market.
 - Compact T 80/T 90 piston burettes and simple control unit TR 85.
- 1988 Presented the first PC-controlled titration system TPC 2000 at the Achema 1988.
- 1989 With the AVS® 500, the tradition of successful automatic samplers for determination of the viscosity of aggressive polymer solutions was continued.
- 1990 REFERID® electrodes with polymer electrolyte, low-maintenance.
- 1991 Low-impedance Type L pH glass for low temperatures and ultrapure water.
 - Automatic sampler TW 280.
- 1992 TT electrodes, capable of withstanding up to -60 °C.
 - T 200 and T 110 piston burettes and universal titration control unit TC 1200.
- 1993 Combination pH electrodes with temperature sensor and plastic shaft.
- 1994 Compact TitroLine® alpha titrator.
- 1995 SILAMID®, stable reference system.
 - First Windows® titration software TitrSoft 1.0 (WIN 3.1).
- 1996 New SMEK shielded 6-pin plug system.
- 1997 New BlueLine range of laboratory electrodes and VP plug system.
 - Electrodes with certified pressure and temperature range.
 - Market launch of the ViscoClock for capillary viscosity measurement.
- 1998 Development of TitrSoft 2.0 software (as of WIN 95).
- 1999 Range of industrial electrodes up to 10 bar and 135 °C, SMEK plug system in IP 68 version.
 - New Type A pH glass, rapid reaction in drinking water.
 - Market launch of the fully automatic AVS®Pro viscosity measurement system for high sample throughput.
- 2000 Introduction of a completely new series of compact, simple piston burettes and titrators: TITRONIC® basic, TITRONIC® universal and TitroLine® easy.
 - Introduction of the Karl Fischer titration system TitroLine® KF.
- 2001 Development and production of SteamLine process electrodes for CIP and SIP applications in the pharmaceutical, food and chemical sectors.
- 2002 Sales launch of newly developed "plus" product line: TitroLine® alpha plus, T 110 plus.
 - Introduction of TW alpha plus sample changer.
 - Market launch of TitrSoft 2.5 software.
- 2003 The compact and highly flexible AVS® 370 viscosity measurement system is presented to the market.
 - Change of company name to SCHOTT® Instruments GmbH, Mainz, integration into the internationally active Nova Analytics Group.
- 2004 Amalgamation and further development of the laboratory electrode product range for the most exacting requirements in the "ScienceLine" product line.
 - The new generation of automatic viscosity measurement systems is rounded off with the AVS® 470.
- 2005 The Lab meters family is introduced:
 - A wireless sensor recognition guarantees the optimum communication between electrode and meter.
- 2006 Introduction of the ProLab family of instruments: Multi-functional measuring instruments with integrated user recognition guarantee utmost flexibility and reliability of measurement.
- 2007 ProLab 3000 and 4000 high-end laboratory instruments signify the cutting-edge standard for pH/ionic and conductivity measuring and for the first time combine highest measuring quality with functionality, also providing a user-friendly navigation comparable to a Windows® PC.
 - The new Karl Fischer titrator, TitroLine® KF trace from SCHOTT® Instruments, also offers a coulometric technique for determining even smallest water content.
- 2008 The new IoLine electrodes with their patented iodine/iodid three-chambers reference system represent the perfect solution for accomplishing the ultimate challenging measuring tasks in i.e. pharmacy, biotechnology and food industry.
- 2009 SCHOTT® Instruments GmbH becomes SI Analytics GmbH.
- 2010 SI Analytics becomes part of ITT, USA.
- 2011 The new titrators TitroLine® 6000/7000 and the new Piston burette TITRONIC® are introduced.
 - The fluidtechnology part of the ITT group SI Analytics belongs to, becomes a stand-alone stock traded company named Xylem Inc.
- 2012 The new titrator series TitroLine® was supplemented by the new KF titrators TitroLine® 7500 KF (volumetric) and TitroLine® 7500 KF trace (coulometric).
 - Introduction of Memosens® electrodes for contactless connection to measurement devices.
- 2015 The new mobile pH meters of the HandyLab MKII and HandyLab 7series enter the market.
 - TitroLine® 7800 with IDS input, the most powerful titrator to date, is available for sale.
- 2016 SI Analytics merges with other German companies of the Xylem group to form Xylem Analytics Germany GmbH. The strong brands such as SI Analytics remain vital.
 - ViscoClock plus is the latest development in the field of viscometry and is very popular from the beginning.

View over Mainz with premises of Xylem Analytics Germany / SCHOTT AG

Source of image: SCHOTT AG

What can Xylem do for you?

We're a global team unified in a common purpose: creating advanced technology solutions to the world's water challenges. Developing new technologies that will improve the way water is used, conserved, and re-used in the future is central to our work. Our products and services move, treat, analyze, monitor and return water to the environment, in public utility, industrial, residential and commercial building services, and agricultural settings. With its October 2016 acquisition of Sensus, Xylem added smart metering, network technologies and advanced data analytics for water, gas and electric utilities to its portfolio of solutions. In more than 150 countries, we have strong, long-standing relationships with customers who know us for our powerful combination of leading product brands and applications expertise with a strong focus on developing comprehensive, sustainable solutions.

For more information on how Xylem can help you, go to www.xylem.com

SI Analytics a xylem brand

Xylem Analytics Germany Sales GmbH & Co. KG SI Analytics

Hattenbergstr. 10
55122 Mainz
Germany

Phone: +49(0).6131.66.5111
Fax: +49(0).6131.66.5001
E-Mail: si-analytics@xylem.com
Internet: www.si-analytics.com

SI Analytics in North America:

P.O. Box 9010
151 Graham Road
College Station, Texas 77842-9010, USA

Toll-free: 866-691-7954
Local: 979 690 5563
E-Mail: information.request@xylem.com
Internet: www.si-analytics.com

Xylem Analytics in other countries:

www.xylemanalytics.com

presented by