

Valid for Item-No.: 772363

Related box: 770310 (red insert)

CONFIDENTIAL

SECTION A-A

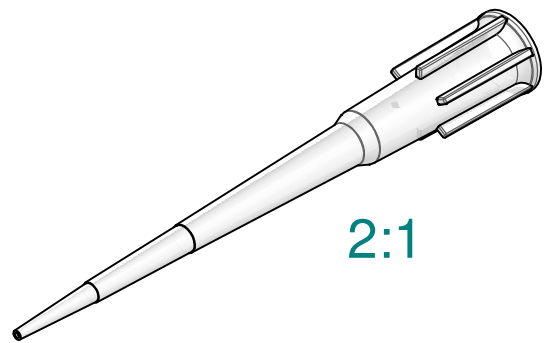
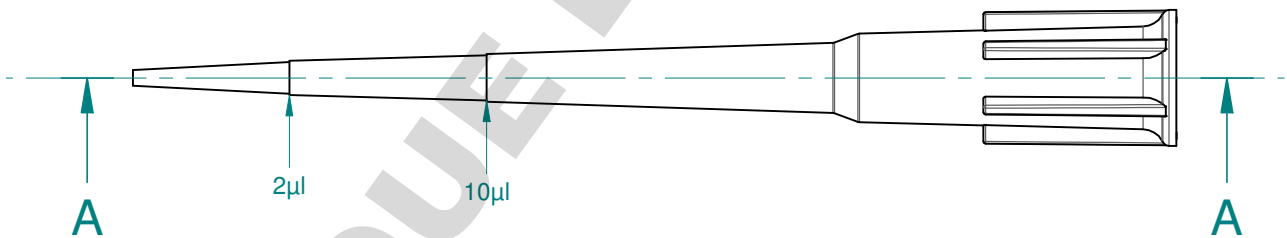
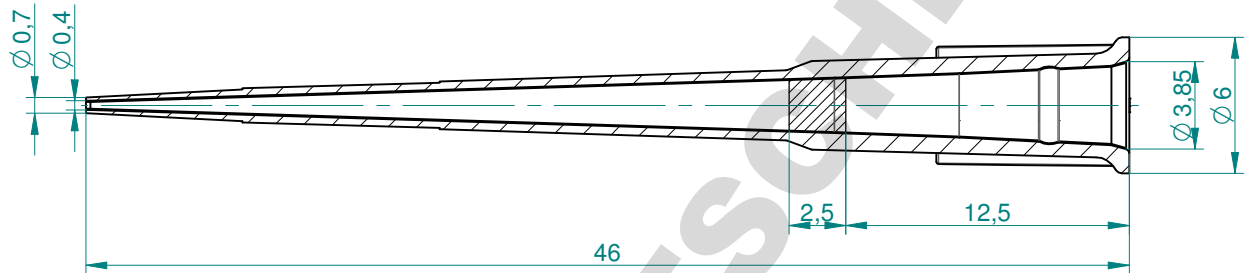

"All dimensions in mm"

Customer drawing subject to change without notice!

Uncontrolled Copy

Prior Issue	Drawn	Approved	Released	CONFIDENTIAL: Information contained in this document or drawing is confidential and proprietary to Greiner Bio-One GmbH. This document may not be reproduced for any reason without written permission from Greiner Bio-One GmbH. All rights of design, invention, and copyright are reserved.
Revision	Date	Date	Date	
-	24.07.2019	Jul. 2019	Jul. 2019	
Date	Name	Name	Name	
-	N. Schöfecker	M. Mizelli	R. Heller	