

Pipet-Lite™ XLS+™

Manual Pipettes with RFID

Operating Instructions

Single-channel



Multichannel



Adjustable Spacer



METTLER TOLEDO



Pipet-Lite XLS and XLS+ Manual Pipettes with RFID

- **Single channel models with LTS or universal-fit shafts**
- **Multichannel models with LTS**
- **Adjustable spacer multichannel models with LTS**
- **RFID enabled, all models**

Table of Contents

1.1	Introduction	3
1.2	Setting Volume	4
1.3	Tip Selection and Mounting	6
1.4	Tip Immersion Depth	6
1.5	Operation	7
1.6	Tip Ejector Arm Removal	8
1.7	Storage	8
1.8	Care and Maintenance	8
1.9	Autoclaving	10
1.10	Upgrading your Pipette to XLS+	10
1.11	Troubleshooting	11
1.12	Service, Calibration, and Repair	11
1.13	Replacement Parts	12
2.1	RFID (Radio-Frequency Identification)	14
3.1	Pipet-Lite XLS+ Multichannel Pipettes	14
4.1	Pipet-Lite XLS Adjustable Spacing Pipettes	16
5.1	Specifications – All Models	inside back cover

Contents of box

- Pipette model as ordered
- Conformance Certificate / Warranty Card

If any item is missing please call 800-4-RAININ (800-472-4646) in the US, or contact your local MT office or distributor.

Rainin, Pipet-Lite, XLS, XLS+, LTS, LiteTouch, Hang-Ups are trademarks of Rainin Instrument, LLC. Pipet-Lite pipettes are manufactured under U.S. Patent Nos. 5,614,153; 5,700,959; and 5,849,248. For use under U.S. patents 6,168,761 B1; 6,171,553 B1; and D426,643.

©2017 Mettler-Toledo Rainin, LLC. No part of this manual may be copied without the express written permission of Mettler-Toledo Rainin, LLC.

1.1 Introduction

Rainin's Pipet-Lite XLS and XLS+ family is continually being upgraded with new features to further improve ergonomics while maintaining high accuracy and performance. The pipette is available in several versions, outlined below; this manual will describe all models.

Single-channel

11 models for volumes from 0.1 μL to 20 mL

Multichannel

12 models for volumes from 1 μL to 1200 μL , including 8 and 12 channels

Adjustable-spacer

5 models for volumes from 5 μL to 1200 μL including 6 and 8 channels, with nozzle spacing adjustable from 9-19 or 9-14 mm.

Spring forces are reduced even further over previous models. With a contoured handle with fingerhook, the pipette is designed for maximum comfort and enhanced performance.

New enhancements for Pipet-Lite XLS+ single channel include low stiction* seals for incredibly smooth operation and a tough high-density polymer tip ejector that is corrosion free and easy to release in one smooth action.

Pipet-Lite XLS+ multichannels are enhanced with low stiction seals and are up to 35% lighter than the previous model with even lower plunger forces.

In models with LTS™ shafts (L-model single channels, all multichannels and adjustable spacers), the patented LTS LiteTouch™ Tip Ejection System reduces tip ejection forces by up to 85% in the single-channel L models, and provides absolutely consistent sample pickup across all channels in multichannel models, as well as reducing tip ejection force.

Finally, all models contain an RFID tag (radio-frequency identification) for facilitating calibration management when using the optional SmartStand and EDPAM software.

*stiction = static friction



Figure 1: Pipet-Lite XLS+

1.2 Setting Volume

1. Turn the volume lock lever to the “unlock” position so the volume setting mechanism is unlocked and free to turn. See left image in Figure 2.



Figure 2: Volume Lock Control

2. With the mechanism unlocked, orient the pipette so you are looking at the volume indicator, then rotate the plunger button to change volume – counter-clockwise to increase, and clockwise to decrease volume.

2 µl	10 µl	20 µl	100 µl	200 µl	300 µl	1000 µl	2000 µl	5000 µl	10 ml	20 ml
1 2 5	0 7 5	1 2 5	0 7 5	1 2 5	2 2 5	0 7 5	1 2 5	4 2 5	0 7 5	1 2 5
1.25 µl	7.5 µl	12.5 µl	75 µl	125 µl	225 µl	0.75 ml	1.25 ml	4.25 ml	7.5 ml	12.5 ml

Figure 3: Volume Indicator by Pipette Model

Read the volume indicator from the top down:

2–20 µL: Black digits indicates µL. Red digits – tenths, hundredths of µL.

100–300 µl: All digits black – µL.

1000–5000 µL: red digit – mL. Black digits– tenths, hundredths of mL.

10 mL and 20 mL: Red digit – mL. Black digits – tenths of mL.

3. To eliminate errors due to mechanical backlash: when setting the desired volume, first turn the knob 1/3 turn above the desired volume. Then turn the knob slowly clockwise until the desired volume is displayed. Always dial down to the desired volume.
4. Turn the volume lock to the “lock” position (Fig. 2 above) to prevent changes to the volume setting. Some volumes for the 200 µL model are shown in Figure 4.

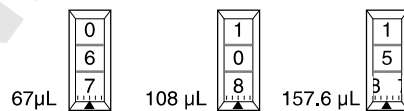

Figure 4: Example volumes

Volume ranges and increments for each model are shown below:

Single-Channel

Volume	Adjustable Range μL	Recommended Range μL	Increment μL
2 μL	0 to 2	0.1 to 2	0.002
10 μL	0 to 10	0.5 to 10	0.02
20 μL	0 to 20	2 to 20	0.02
100 μL	0 to 100	10 to 100	0.2
200 μL	0 to 200	20 to 200	0.2
300 μL	0 to 300	20 to 300	0.5
1000 μL	0 to 1000	100 to 1000	2.0
2000 μL	0 to 2000	200 to 2000	2.0
5000 μL	0 to 5000	500 to 5000	5.0
10 mL	0 to 10 mL	1 mL to 10 mL	20.0
20 mL	0 to 20 mL	2 mL to 20 mL	20.0

Multichannel and Adjustable-Spacers

Volume	Adjustable Range μL	Recommended Range μL	Increment μL
10 μL	0 to 10	0.5 to 10	0.02
20 μL	0 to 20	2 to 20	0.02
50 μL	0 to 50	5 to 50	0.05
100 μL	0 to 100	10 to 100	0.2
200 μL	0 to 200	20 to 200	0.2
300 μL	0 to 300	20 to 300	0.5
1200 μL	0 to 1200	100 to 1200	2.0

Filter

The 5000 μL , 10 mL, and 20 mL pipettes use a filter in the end of the shaft to help prevent liquid entering the shaft and contaminating the piston, should the plunger snap up during aspiration. Using a filter is recommended when pipetting large volumes. Replace the filter if it gets wet.

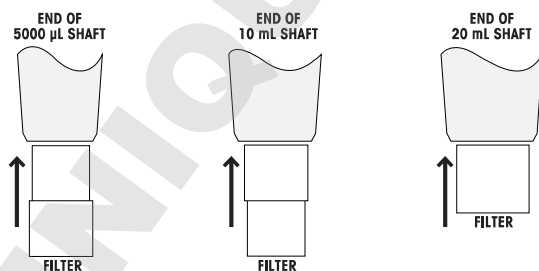

Figure 5: Filter orientation

The 5000 μL and 10 mL pipettes use the same filter, as shown in the diagram above:

5000 μL : small diameter into the shaft. 10 mL: large diameter into the shaft.

Filter part numbers are 17001944 (pack of 100) and 17001945 (pack of 1000).

The filter for the 20 mL model is a cylinder.

Part numbers: 17001951 (pack of 100), 17001952 (pack of 500).

1.3 Tip Selection and Mounting

Rainin pipettes and tips are designed together as a pipetting system, both in LTS and traditional versions. All Rainin tips are BioClean and totally inert, so you can be assured of the best pipetting results.

Rainin pipettes are calibrated with Rainin tips, and performance to published specifications can only be guaranteed when Rainin tips are used.

To mount a tip, press the pipette shaft into the end of the tip with light force. With both LTS and traditional versions, the tip will seal properly on the shaft with minimal force — do not use more force than is required.

1.4 Tip Immersion Depth

The recommended depth for tip insertion into the sample for each model is shown below.

Nominal Volume	Volume Range	Immersion Depth
2 μL	0.1 - 2 μL	1-2 mm
10 μL	0.5 - 10 μL	1-2 mm
20 μL	2 - 20 μL	2 - 3 mm
100 μL	10 - 100 μL	2 - 3 mm
200 μL	20 - 200 μL	3 - 6 mm
300 μL	20 - 300 μL	3 - 6 mm
1000 μL	100 - 1000 μL	3 - 6 mm
2000 μL	200 - 2000 μL	3 - 6 mm
5000 μL	500 - 5000 μL	6 - 10 mm
10 mL	1 mL - 10 mL	6 - 10 mm
20 mL	2 mL - 20 mL	6 - 10 mm

Tip immersion depth is critical and should not be exceeded, or the volume measured may be inaccurate, possibly out of specification. The tip angle is also important – the pipette should always be used in a position within 20 degrees of vertical. See Figure 6 below.

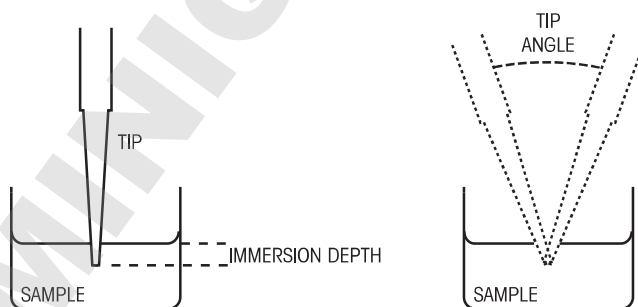

Figure 6: Tip Immersion Depth and Tip Angle

1.5 Operation

Before pipetting valuable samples, it is good to practice aspirating and dispensing water.

1. Set the desired volume as described on page 4.
2. Attach a new Rainin tip. Press the shaft into the tip with sufficient force to make a good seal.
3. Press the plunger button to the first stop, and hold it in this position. See the diagram below for a depiction of the first and second stops.

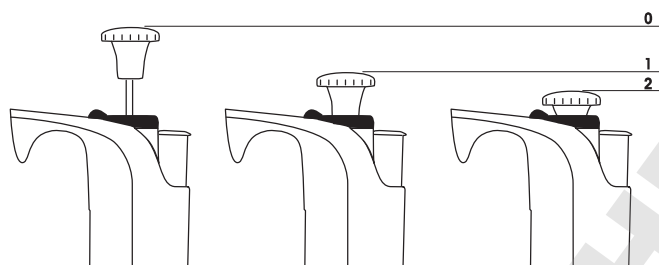

Figure 7: Neutral position (0), First stop (1), and Second stop (2)

Aspiration:

1. Holding the pipette vertically (or within 20° of vertical), place the tip into the sample to the proper depth and relax your thumb pressure on the plunger. The light piston spring will move the piston upward, aspirating sample. Do not let go of the plunger button, or the piston may snap up quickly, resulting in inaccurate measurement.
2. Pause for about 1 second (longer for macro-volume pipettes) to ensure that the full volume of sample is drawn into the tip.
3. Withdraw the tip from the sample. If any liquid remains on the outside of the tip, touch it off carefully onto a lint-free tissue, taking care not to touch the tip orifice.

Dispensing:

1. Touch the tip end against the side wall of the receiving vessel and press the plunger slowly, past the first stop, to the second stop, or blowout (bottom of stroke.)
Wait: 1 second for 2-300 μL volumes, 1-2 seconds for 1000 μL and larger.
(For viscous solutions pause before blowout.)
2. Still holding the plunger, withdraw the tip, sliding it along the wall of the vessel. Release the plunger.
3. Press the tip ejector button lightly to discard the tip. Use a new tip for each sample to prevent carry-over. Repeat for the next pipetting cycle.

Pipetting Guidelines

You should maintain:

1. Consistent pickup and dispense rhythm.
2. Consistent speed and smoothness when pipetting.
3. Consistent pressure on the plunger button at the first stop.
4. Consistent immersion depth. See Figure 6.
5. Pipette vertically, or within 20° of vertical.
6. Pre-rinse the tip twice by aspirating and dispensing sample before actual pickup.
7. Don't invert or lay the pipette flat with liquid in the tip.

More information on Good Pipetting Technique, including a Lab Poster, can be found on the Rainin and MT websites: www.shoprainin.com or www.mt.com/gpp.

1.6 Tip Ejector Arm Removal

Four types of tip ejector are used and all types can be removed with minimum effort – do not use force.

For models up to 2000 μL

Metal tip ejector: press in the quick-release tabs on the ejector arm and pull the arm down.

Plastic tip ejector: grasp firmly on the ejector arm and pull down.

For 5000 μL & 10 mL models: grasp the top of the ejector arm and pull out then down.

For the 20 mL model: pull off the lower part of the ejector arm; the upper part stays in place. (Replace by aligning the rod with the hole in the upper part and pressing firmly.)

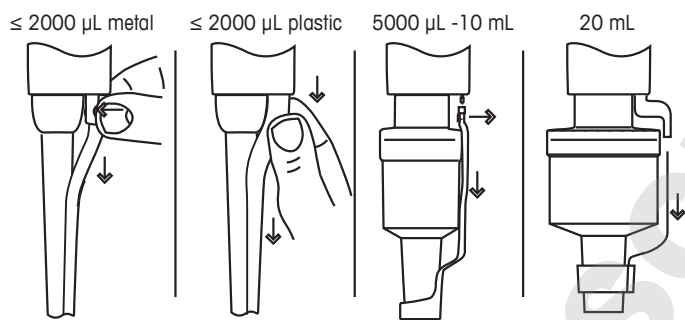

Figure 8: Removing Tip Ejector Arm

To replace the ejector arm (except 20 mL described above), insert the shaft through the large opening, align the top of the ejector arm with the tip ejector push-rod, and push the ejector arm firmly until it is securely in place.

1.7 Storage

After use, store the pipette in a clean safe place. Four types of hangers are available to hold your pipette conveniently when not in use.

SmartStand: RFID reader-enabled stand holds four pipettes.

CR-7: Free-standing carousel holds seven pipettes.

HU-M3: Set of three individual magnetic Hang-Ups™ for mounting on ferrous surfaces.

HU-S3: Three Hang-Ups attached to a clamp which fits onto a shelf

1.8 Care and Maintenance

Caution: When pipetting, never allow liquid to enter the shaft, where it may contaminate the piston and seal. When removing the shaft from the pipette body, make sure the spring, seal and seal retainer do not fall off the piston, especially the smaller models, as they may be difficult to find!

Your pipette is a sophisticated high precision lab instrument, and should be treated with appropriate care. The two biggest sources of damage occur with sample contamination inside the shaft, or with dropping the pipette. Filter tips and proper technique can mitigate the risk of sample contamination. Storing your pipette on appropriate hangers when not in use will reduce the chance of drops.

Sample contamination of the shaft, seals or piston can cause rough, sticky plunger movement. Eventually deposits on the piston can cause the seal to tear, leading to inaccurate results. Best practice for pipette maintenance is to regularly clean the pipette liquid end with the following procedure:

1. Remove tip ejector arm (See Tip ejector arm removal Figure 8).
2. On pipettes up to 1000 μL unscrew the shaft coupling nut and remove shaft. For 2000 μL unscrew the shaft. For pipettes $>2000 \mu\text{L}$ unscrew the lower part of the shaft.
3. When you remove the piston assembly, note the order and placement of the seals, retainers, springs and o-rings on the piston assembly. XLS+ seals for models 100-2000 μL are asymmetrical and must be inserted in the correct orientation (See Figure 9). XLS+ seals for models 2-20 μL are symmetrical and can be used in either orientation.
4. XLS+ seal sizes 1000-2000 μL may remain inside the shaft when you remove the piston assembly; this is normal for this design. The seals may be removed from the shaft by inserting the large end of a tip into the shaft (See Figure 9) and hooking the seal over it.
5. To inspect and clean seals sized 100-300 μL , remove them gently from their retainers by pushing them out from the back side, preferably with a non-sharp object like a pipette tip.
6. Inspect the seals, retainers, o-rings, shaft and piston for contamination. Clean with a lint-free cloth with either distilled water or isopropyl alcohol. Apply grease (part number 17014531) sparingly by gently rubbing the seal or o-ring between the thumb and index finger, ideally using a clean powder-free examination glove. Apply a small amount of grease on the piston as well.
Reassemble in the correct order and orientation.
7. If piston corrosion or staining is evident do not use the pipette and have a METTLER TOLEDO Service representative assist with replacement of the piston.
8. The shaft, tip ejector and handle may also be cleaned using a damp cloth with distilled water, 10% bleach solution, isopropyl alcohol, or any commercially available instrument decontamination solution. Be sure to rinse off the cleaning agent with distilled water.

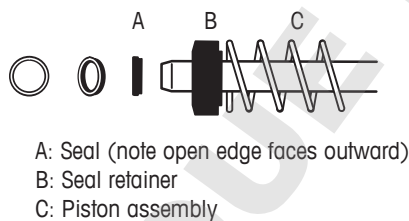

Figure 9A: Seal orientation,
100, 200 and 300 μL

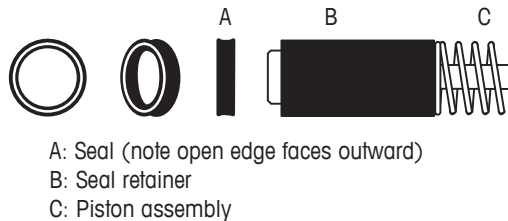

Figure 9B: Seal orientation,
1000 and 2000 μL

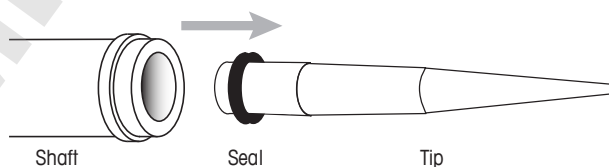

Figure 9C: Using the large end of a tip to remove 1000 or 2000 μL XLS+ seal from the shaft

1.9 Autoclaving

Autoclaving of your pipettes to perform sterilization may be performed at 121°C, at 1 Bar, for 15-20 minutes, with the following restrictions and guidelines.

Do not autoclave the entire pipette or any part not specifically identified in the table below.

Pipette line	Model Range	Autoclaveable parts
Pipet-Lite, Pipet-Lite XLS	All single channel models	Shaft and tip ejector
Pipet-Lite XLS+	Single channel models 2 - 2000 µL	Shaft, tip ejector, piston assembly, spring, seal, and seal retainer
Pipet-Lite, Pipet-Lite XLS, Pipet-Lite XLS+	All multichannels, adjust- able spacers	None

The entire liquid end of Pipet-Lite XLS+ single channel pipettes may be removed and placed into the autoclave without disassembling individual parts. The liquid end includes the following: Shaft, tip ejector, piston assembly (with spring), seal and seal retainer. If you have upgraded the seals of an older Pipet Lite or Pipet Lite XLS to the new XLS+ seals (see section 1.10), you can now autoclave the entire liquid end of your pipette. If you are unsure of your model type see section 1.10.

If autoclaving more than one unit together, take care to reassemble your pipettes with all of their original parts. If you clean the XLS+ piston and seals before autoclaving then be sure to re-grease them afterwards (see Care and Maintenance).

See Care and Maintenance and Replacement Parts sections for more details on disassembling pipettes, and how to identify the different parts.

1.10 Upgrading your Pipette to XLS+

The XLS+ single channel line of pipettes is distinguished from earlier models by having a new lower stiction sealing system, a completely autoclaveable liquid end, and a durable, corrosion-free plastic tip ejector.

If you have a single channel Pipet-Lite or Pipet-Lite XLS pipette in the 2-2000 µL range, you can upgrade your liquid end to experience the superior benefits of XLS+.

You can differentiate an XLS+ pipette from the earlier XLS version in the following ways: an original XLS+ pipette will have a serial number beginning with C14 (or higher) but not A14 or B14. Also the RAININ logo on the silver badge is colored blue. All the XLS+ seals are black, and no o-rings are used, while the XLS seals are white, and o-rings sit below the seal on the piston.

You can upgrade your liquid end by ordering the seal replacement kit (see 1.13, Replacement Parts). The new XLS+ seals require grease part# 17014531 (see 1.8, Care and Maintenance). For the 1000 and 2000 µL models, replacing the seal retainer requires specialized tools and handling to avoid damage to the piston. Please call technical support (800-543-4030 in the USA) or your local METTLER TOLEDO service provider.

1.11 Troubleshooting

Problem	Possible Cause	Suggested Remedy
Leaks, inaccuracy	Loose shaft	Tighten coupling nut by hand.
	Worn seal for pipette volumes $\leq 2000 \mu\text{L}$	Replace seal
	Worn o-ring or insufficient grease seal for pipette volumes $5000 \mu\text{L}$, 10mL , 20mL	Replace o-ring and apply small amount of grease.
	Cracked or split shaft.	Replace shaft. Check piston is not bent. If bent, contact your Mettler-Toledo or Rainin Service Center (www.mt.com/contact) for a new piston.
Rough, jerky, or sticky plunger movement	Contamination inside mechanism.	Remove tip ejector arm, remove shaft and check piston and seal clean as described in Care and Maintenance section. If piston is permanently corroded or stained, contact your Mettler-Toledo or Rainin Service Center (www.mt.com/contact) for a new piston.
	Insufficient grease	Apply grease sparingly to seal or o-ring

When removing the shaft from the pipette body, make sure the spring, seal and o-ring do not detach from the piston, especially on the smaller models. Be careful not to bend the piston on these small models. Recalibration of Pipet-Lite XLS is only required when the piston is replaced.

1.12 Service, Calibration and Repair

It is recommended to use only genuine Rainin replacement parts such as seals, o-rings, retainers and shafts. It is NOT necessary to recalibrate the pipette after changing the seal, o-ring, or shaft. Recalibration of the pipette is only necessary when the piston is replaced, and should be done only by qualified factory-trained personnel in a Rainin approved facility.

For pipettes under warranty, please note that the warranty will be voided if the pipette has been damaged as a result of physical or chemical abuse, or if the pipette has been repaired or recalibrated by any service facility which is not authorized by Rainin. In the US, call 800-543-4030 for service. Service is also available outside the US.

See www.mt.com/rainin for more information.

Acids and Corrosives

Extensive contact with corrosive fumes may result in premature seal wear and damage to the piston. Exposure of the internal components to corrosive aerosols and fumes may be reduced by using Rainin tips with aerosol barrier filters.

After using concentrated acids or corrosive solutions, you can disassemble Pipet-Lite XLS and inspect and clean the piston assembly, shaft and seal / o-ring with distilled water. Use extreme care on the $2 \mu\text{L}$ and $10 \mu\text{L}$ models to avoid damaging the small diameter piston, or losing small items such as seals. Dry all components thoroughly and reassemble.

1.13 Replacement Parts

The commonly-replaced parts are shown here for each volume range for Pipet-Lite XLS, single-channel LTS and universal-fit models.

The images in Figure 10 represent the 20, 200 and 1000 μL models (top) and the 10 mL model (bottom) – other models are similar.

XLS+ Models $\leq 2000 \mu\text{L}$	Order #	Seal Replacement Kit ^{1,3,5}		Shaft ¹ Order #	Tip Ejector Metal ¹ Order #	Tip Ejector Plastic ² Order #
		Order #	Order #			
L-2XLS+	17014393	17014517		17004866	17005287	17014524
L-10XLS+	17014388	17014518		17004862	17005287	17014524
L-20XLS+	17014392	17014519		17004861	17005287	17014524
L-100XLS+	17014384	17014513		17004859	17005293	17014525
L-200XLS+	17014391	17014520		17004860	17005293	17014525
L-300XLS+	17014405	17014521		17007551	17007556	17014526
L-1000XLS+ ⁴	17014382	17014522		17004858	17005294	17014527
L-2000XLS+ ⁴	17014390	17014523		17004856	17005296	17014528
SL-2XLS+	17014413	17014517		17004853	17005292	17014529
SL-10XLS+	17014409	17014518		17004845	17005292	17014529
SL-20XLS+	17014412	17014519		17004847	17005288	17014524
SL-100XLS+	17014408	17014513		17004848	17005289	17014530
SL-200XLS+	17014411	17014520		17004849	17005291	17014525
SL-300XLS+	17014414	17014521		17007554	17007556	17014526
SL-1000XLS+ ⁴	17014407	17014522		17004850	17005290	17014527
SL-2000XLS+ ⁴	17014410	17014523		17004846	17005296	17014528
Grease for all models $\leq 2000 \mu\text{L}$: 17014531						

XLS Models $\geq 5000 \mu\text{L}$	Order #	Piston O-Ring Order #	Cylinder O-Ring Order #	Shaft Order #	Tip Ejector Order #
L-5000 XLS	17011790	17003382	17003477	17004857	17005297
L-10ML XLS	17011783	17003383	17003476	17004855	17005295
L-20ML XLS	17011788	17003413	17003478	17004908	17005308
SL-5000 XLS	17011801	17003382	17003477	17004852	17005297
SL-10ML XLS	17011795	17003383	17003476	17004851	17005295
Filters for 5 mL and 10 mL XLS models: 17001944 (pack of 100), 17001945 (pack of 1000)					
Filters for 20 mL XLS models: 17001951 (pack of 100), 17001952 (pack of 500)					

Notes

- Parts are back compatible with Pipet-Lite and Pipet-Lite XLS.
- Parts are back compatible with Pipet-Lite XLS only.
- XLS+ seals and retainers must be used together.
- 1000 μL and 2000 μL Pipet-Lite and Pipet-Lite XLS models require service to upgrade to XLS+ seal retainers.
- Seal replacement kit includes seal, seal retainer, and grease.

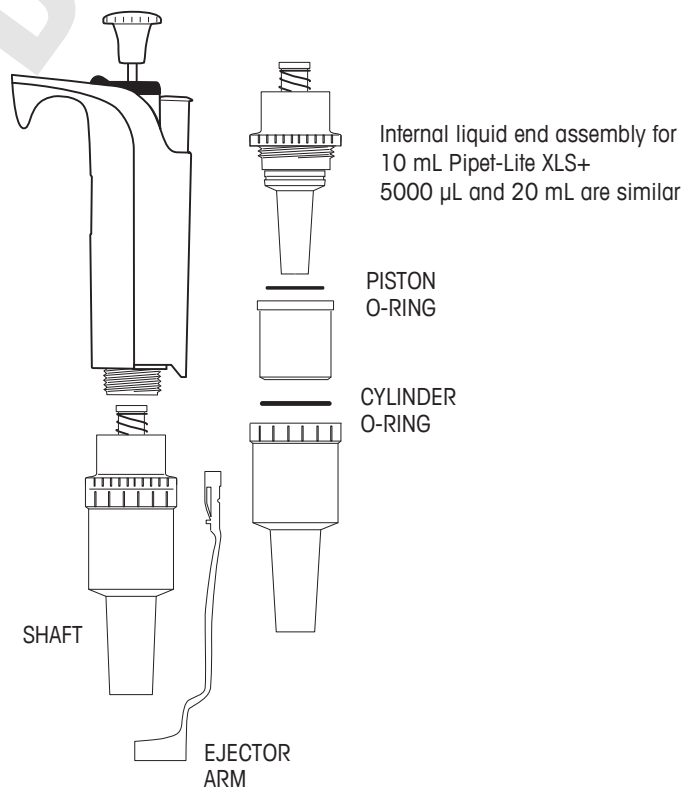
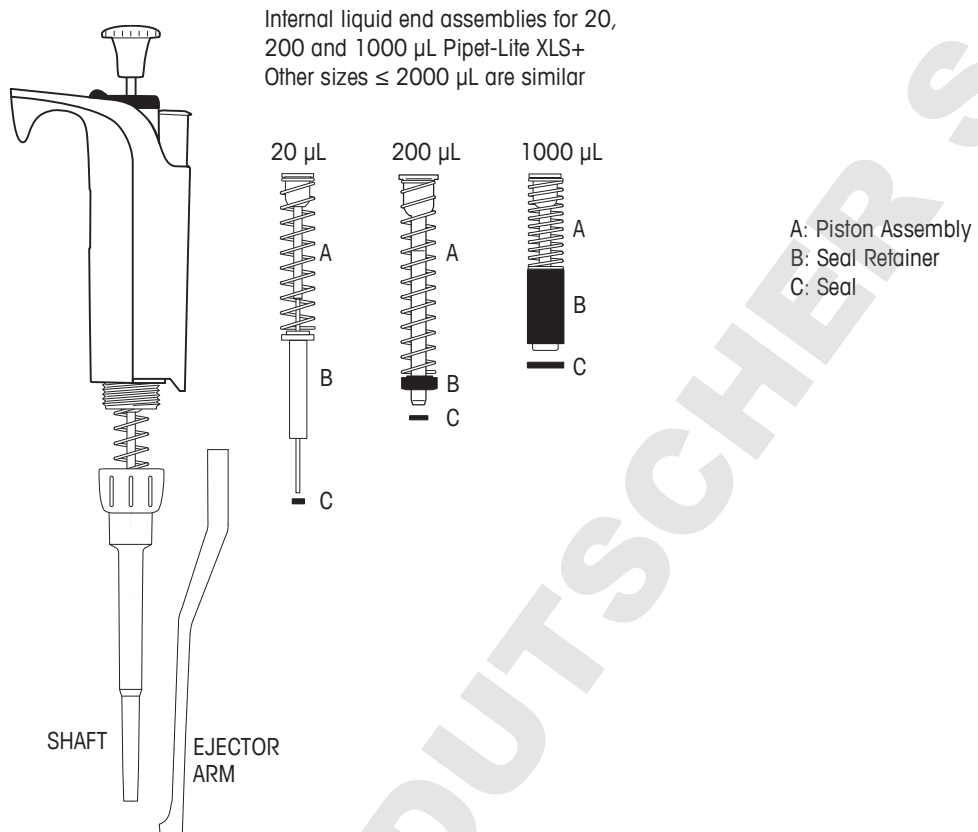

Figure 10: Common Replacement Parts
Top < 2000 μL Bottom > 5000 μL

2.1 RFID (Radio Frequency Identification Device)

All Pipet-Lite XLS models incorporate a passive RFID tag in the finger-hook, containing unique information about the pipette, including model type, serial number, RFID UID and service calibration information. The RFID tag can be wirelessly linked with the SmartStand and EDPAM software to facilitate querying calibration tracking and service reminders. The RFID tag has negligible weight with no effect on precision or accuracy. It operates only when read by the SmartStand and EDPAM software.

3.1 Pipet-Lite XLS+ Multichannel Pipettes 8 and 12-channel models

Introduction

Pipet-Lite XLS+ multichannel pipettes are based on the Pipet-Lite XLS+ single-channel pipette and use the patented LTS LifeTouch Tip Ejection System.

Two versions of the Multichannel Pipet-Lite XLS+ are available: 8-channel and 12-channel. An 8-channel version is shown in Figure 11.

The 8- and 12-channel models are available in 6 volume ranges:

- 0.5 -10 μL
- 2-20 μL
- 5-50 μL
- 20-200 μL
- 20-300 μL
- 100-1200 μL

Tip Selection

Pipet-Lite XLS multichannel pipettes use Rainin LTS tips.

- 10-20 μL : 20 μL LTS tips
- 50-200 μL : 250 μL LTS tips
- 300 μL : 300 μL LTS tips
- 1200 μL : 1200 μL LTS tips (recommended) or 1000 μL LTS tips – pick up 1200 μL (except with filter)

LTS tips have a cylindrical cross-section with a well-defined seal ring, thin wall, and positive stop. They seal properly on the shaft and cannot be jammed or forced too far onto the shaft nozzles, and provide absolutely consistent sample pickup across all channels.



Figure 11: Pipet-Lite XLS+ Multichannel Pipette

Mounting LTS Tips: 8- and 12-channel

Mounting racked LTS tips on L8 and L12 pipettes is simple. First align the shaft nozzles into the row of tips, holding the pipette at an angle. (Figure 12A). Position the pipette upright and press the nozzles into the tips until the “positive stop” is reached. (Figure 12B). The tips are now mounted with proper sealing. You do not need to hand-tighten, use heavy pressure, or “rock” the nozzles onto the tips to obtain a good seal.



Figure 12: Mounting racked LTS Tips

Tip Immersion Depth

The recommended depth for tip insertion is shown in the table below.

Volume	Immersion Depth
10-50 μL	2 - 3 mm
200-1200 μL	3 - 6 mm

Positioning the Liquid End Manifold

The liquid end manifold can be rotated to any angle for convenience when filling plates. You do not need to loosen the coupling nut.

4.1 Pipet-Lite XLS Adjustable Spacing Pipette 6 and 8-channel models

Introduction

Pipet-Lite XLS Adjustable-Spacer multichannel pipettes are based on Pipet-Lite XLS single-channel pipettes, and operate in the same way.

Two versions of the Pipet-Lite XLS Adjustable-Spacer pipette are available: 6-channel (LA6) and 8-channel (LA8), with nozzle spacing adjustment ranges shown below:

6-channel	9 mm to approx. 19 mm
8-channel	9 mm to approx. 14 mm

6- and 8-channel versions are available in the volume ranges: 20-300 μL and 100-1200 μL .

8-channel versions are also available in the 5-50 μL volume range.

Spacing Controls and Indicators

Nozzle spacing is changed with the use of two knurled knobs on either end of the liquid end manifold: the LIMITER knob and the SPACING ADJUSTMENT knob, shown in Figure 13.

The LIMITER knob (marked with the nozzle spacing range) sets the desired maximum spacing within the pipette's spacing range. A vertical arrow at the top of the knob on the liquid end manifold is the set point, shown in Figure 14.

When you have set the maximum spacing with the LIMITER knob, turn the SPACING adjustment knob to open the nozzle spacing to the set value. A scale on the liquid end manifold gives a visual reference of the set spacing. Simply line up the leftmost nozzle with the scale on the manifold, as shown in Figure 14.



Figure 13: Pipet-Lite XLS Adjustable-Spacer Pipette



Figure 14: Liquid End Marks

The full range of adjustment for the eight-channel version is shown below in Figure 15. Nozzles are set to 9 mm spacing on the left and 14 mm spacing on the right.

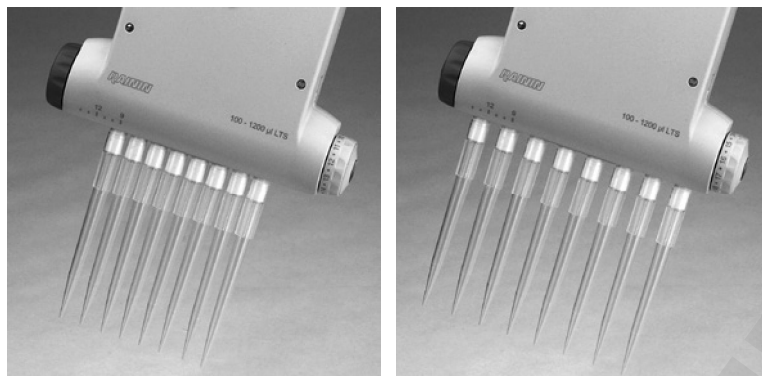

Figure 15: Nozzles: minimum spacing & maximum spacing

Tip Selection

Pipet-Lite multichannel pipettes must use Rainin LTS tips.

LA8-50: use 250 μ L LTS tips

LA6-300 and LA8-300: use 300 μ L LTS tips

LA6-1200 and LA8-1200: use 1200 μ L LTS tips (recommended) or 1000 μ L LTS tips – picks up 1200 μ L (except tips with filters)

LTS tips have a cylindrical cross-section with a well-defined seal ring, thin wall, and positive stop. They seal properly on the LTS nozzles and cannot be jammed or forced too far onto the nozzles.

Mounting LTS Tips

Mounting racked LTS tips onto LA6 and LA8 pipettes is simple.

Set the nozzle spacing to 9 mm (same as the spacing for racked tips) by rotating the dark grey SPACING ADJUSTMENT knob fully clockwise.

Align the nozzles into the row of tips, holding the pipette at a slight angle. (Figure 16 left).

Rotate the pipette upright and press the nozzles into the tips until the “positive stop” is reached.

The tips are now mounted with proper sealing. You do not need to hand-tighten, use heavy pressure, or “rock” the nozzles onto the tips to obtain a good seal. Withdraw the tips from the tip rack. (Figure 16 right)

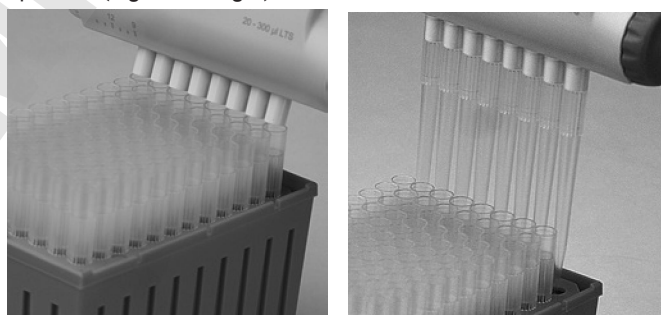

Figure 16: Mounting LTS Tips

Setting the Nozzle Spacing

With tips mounted on the nozzles, and before you begin to aspirate sample:

- If you know the spacing for the receiving wells or test-tube block, set this value on the LIMITER knob.
- If you do not know the spacing, hold the pipette so that the tip ends are above the centers of the wells or test-tube block into which you will dispense. Look at the scale on the liquid end manifold, and note where the marked nozzle aligns. Set this value on the LIMITER knob.
- If you accidentally over-extend the spacing, you can click the LIMITER knob to smaller values, stopping when the tip ends are aligned over the centers of the wells/test tubes.

Once the LIMITER knob has been set, spacing the nozzles properly is simple.

Just pick up sample, set the nozzle spacing by moving the SPACING ADJUSTMENT knob until it stops at the value set by the LIMITER knob, and dispense into the wells or test-tube block.

Tip Immersion Depth

Recommended depth for tip insertion for each Pipet-Lite XLS adjustable-nozzle model:

LA8-50: 2–3 mm

LA6-300, LA8-300, LA6-1200, LA8-1200: 3–6 mm

Operate the pipette within 20 degrees of vertical.

Tip Ejection

Simply press on the tip ejector button. All tips are ejected cleanly with minimal pressure on the thumb because of the progressive eject design built in to the liquid end manifold.

Positioning the Liquid End Manifold

The liquid end manifold can be rotated to any angle for convenience. You do not need to loosen the coupling nut.

5.1 Specifications – All Models

These manufacturer's specifications should be used as guidelines when establishing your own performance specification.

Model	Volume	Increment	Accuracy		Precision	
	μL	μL	%	$\mu\text{L} (\pm)$	%	$\mu\text{L} (\leq)$
2 μL	0.2	0.002	12.0	0.024	6.0	0.012
	1.0		2.7	0.027	1.3	0.013
	2.0		1.5	0.030	0.7	0.014
10 μL	1.0	0.02	2.5 / (4) ¹	0.025 / (0.04) ¹	1.2 / (3) ¹	0.012 / (0.03) ¹
	5.0		1.5	0.075	0.6	0.03
	10.0		1.0	0.1	0.4	0.04
20 μL	2	0.02	7.5	0.15	2.0	0.04
	10		1.5	0.15	0.5	0.05
	20		1.0	0.2	0.3	0.06
50 μL^2	5	0.05	3.5	0.18	1.5	0.075
	25		1.2	0.3	0.4	0.1
	50		0.8	0.4	0.2	0.1
100 μL	10	0.2	3.5	0.35	1.0	0.1
	50		0.8	0.4	0.24	0.12
	100		0.8	0.8	0.15	0.15
200 μL	20	0.2	2.5	0.5	1.0	0.2
	100		0.8	0.8	0.25	0.25
	200		0.8	1.6	0.15	0.3
300 μL	30	0.5	2.5	0.75	1.0	0.3
	150		0.8	1.2	0.25	0.375
	300		0.8	2.4	0.15	0.45
1000 μL	100	2	3.0	3.0	0.6	0.6
	500		0.8	4.0	0.2	1.0
	1000		0.8	8.0	0.15	1.5
1200 μL^2	100	2	3.6	3.6	0.6	0.6
	600		0.8	4.8	0.2	1.2
	1200		0.8	9.6	0.15	1.8
2000 μL	200	2	3.0	6.0	0.6	1.2
	1000		0.8	8.0	0.2	2.0
	2000		0.8	16.0	0.12	2.4
5000 μL	500	5	2.4	12.0	0.6	3.0
	2500		0.6	15.0	0.2	5.0
	5000		0.6	30.0	0.16	8.0
10 mL	1 mL	20	5.0	50.0	0.6	6.0
	5 mL		1.0	50.0	0.2	10.0
	10 mL		0.6	60.0	0.16	16.0
20 mL	2 mL	20	5.0	100.0	0.6	12.0
	10 mL		1.0	100.0	0.2	20.0
	20 mL		0.6	120.0	0.16	32.0

Specifications are subject to change without notice.

¹ Multichannel

² Multichannel models only in these volume ranges

www.rainin.com

For more information

Mettler-Toledo Rainin, LLC

7500 Edgewater Drive
Oakland, CA 94621
Phone +1 510 564 1600

Subject to technical changes
© 2017 Mettler-Toledo Rainin, LLC
Printed in USA 17011990 (EN) Rev I