

Cond 3110

CONDUCTIVITY METER



a xylem brand

DOMINIQUE DUTSCHER SAS

Copyright

© 2017 Xylem Analytics Germany GmbH
Printed in Germany.

Cond 3110 - Contents

1	Overview	5
1.1	Keypad	6
1.2	Display	7
1.3	Socket field	8
2	Safety	9
2.1	Authorized use	10
2.2	General safety instructions	10
3	Commissioning	13
3.1	Scope of delivery	13
3.2	Initial commissioning	13
3.2.1	Inserting the batteries	13
3.2.2	Switching on the meter	14
4	Operation	15
4.1	General operating principles	15
4.1.1	Operating modes	15
4.1.2	Operation	15
4.2	Measuring	16
4.2.1	Measuring the conductivity	17
4.2.2	Measuring the salinity	17
4.3	Determining/setting up the cell constant [C]	19
4.3.1	Determining the cell constant (calibration)	19
4.3.2	Using the last calibrated cell constant	21
4.3.3	Setting the cell constant manually	22
4.4	Temperature compensation TC	25
4.5	Settings	26
4.5.1	System settings	26
4.5.2	Measurement settings	27
4.6	Reset	29
4.6.1	Resetting the cell constant	29
4.6.2	Resetting all meter settings	30
5	Maintenance, cleaning, disposal	31
5.1	Maintenance	31
5.1.1	Replacing the batteries	31
5.2	Cleaning	32
5.3	Packing	32

6	What to do if...	33
7	Technical data	35
7.1	General data	35
7.2	Measuring ranges, resolution, accuracy	35
8	Lists	37

1 Overview

The Cond 3110 compact precision conductivity meter enables you to perform conductivity measurements quickly and reliably. The Cond 3110 provides the maximum degree of operating comfort, reliability and measuring certainty for all applications. The proven procedures for determining or adjusting the cell constant support your work with the conductivity meter.







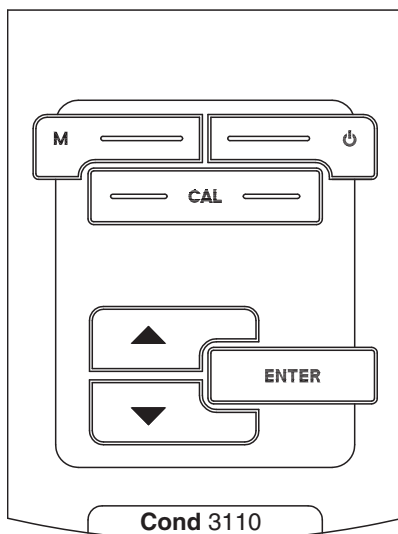

1	Keypad
2	Display
3	Socket field

1.1 Keypad



In this operating manual, keys are indicated by brackets <.> . The key symbol (e.g. <ENTER>) generally indicates a short keystroke (under 2 sec) in this operating manual. A long keystroke (approx. 2 sec) is indicated by the underscore behind the key symbol (e.g. <ENTER__>).

	<On/Off>: Switches the meter on/off <On/Off__>: Resets calibration data
	<M>: Selects the measured parameter <M__>: Opens the setting menu for calibration and measurements
	<CAL>: Calls up the calibration procedure <CAL__>: Displays the calibration data
	<>: Increments values, scrolls
	<>: Decrements values, scrolls
	<ENTER>: Confirms entries <ENTER__>: Opens the setting menu for system settings

1.2 Display

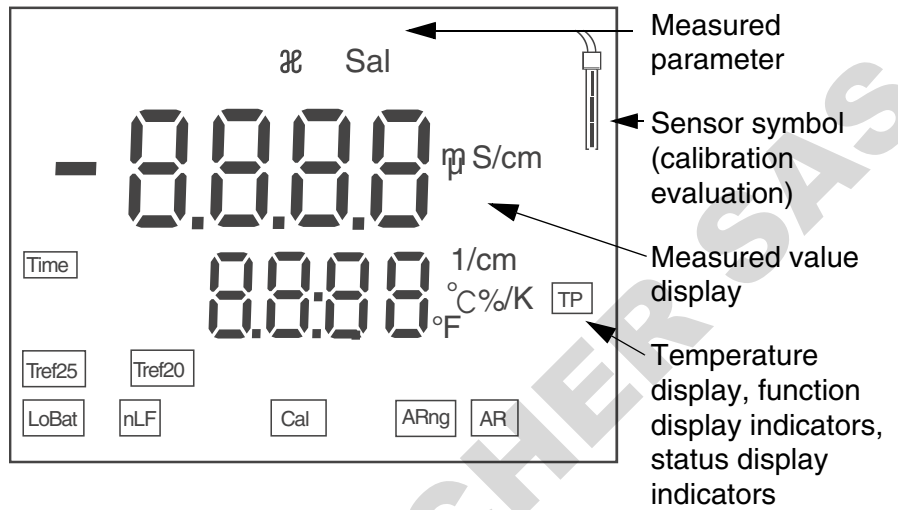

Status display indicators

AR	Stability control (AutoRead) is active
ARng	Automatic range switching; meter measures with highest possible resolution
Cal	Calibration
LoBat	With battery operation: batteries almost empty
nLF	Nonlinear temperature compensation
TP	Temperature measurement active
Tref20	Reference temperature of 20 °C
Tref25	Reference temperature of 25 °C
TIME	Setting of calibration interval

1.3 Socket field

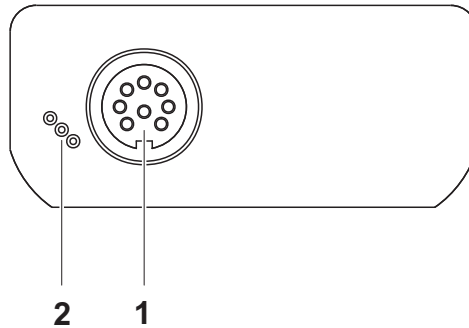

Connectors:

1	Conductivity measuring cell
2	Service interface



Caution

Only connect sensors to the meter that cannot return any voltages or currents that are not allowed (> SELV and > current circuit with current limiting).

Almost all customary measuring cells fulfill these conditions.

2 Safety

This operating manual contains basic instructions that you must follow during the commissioning, operation and maintenance of the meter. Consequently, all responsible personnel must read this operating manual before working with the meter.

The operating manual must always be available within the vicinity of the meter.

Target group

The meter was developed for work in the field and in the laboratory. Thus, we assume that, as a result of their professional training and experience, the operators will know the necessary safety precautions to take when handling chemicals.

Safety instructions

Safety instructions in this operating manual are indicated by the warning symbol (triangle) in the left column. The signal word (e.g. "Caution") indicates the level of danger:



Warning

indicates instructions that must be followed precisely in order to avoid possibly great dangers to personnel.



Caution

indicates instructions that must be followed precisely in order to avoid the possibility of slight injuries or damage to the meter or the environment.

Further notes



Note

indicates notes that draw your attention to special features.



Note

indicates cross-references to other documents, e.g. operating manuals.

2.1 Authorized use

Authorized use of the meter consists exclusively of the measurement of conductivity, temperature and salinity in a laboratory or field environment.

The technical specifications as given in chapter 7 TECHNICAL DATA must be observed. Only the operation and running of the meter according to the instructions given in this operating manual is authorized. Any other use is considered **unauthorized**.

2.2 General safety instructions

This meter is constructed and tested in compliance with the IEC 1010 safety regulations for electronic measuring instruments. It left the factory in a safe and secure technical condition.

Function and operational safety

The smooth functioning and operational safety of the meter can only be guaranteed if the generally applicable safety measures and the specific safety instructions in this operating manual are followed during operation.

The smooth functioning and operational safety of the meter can only be guaranteed under the environmental conditions that are specified in chapter 7 TECHNICAL DATA.

If the meter was transported from a cold environment to a warm environment, the formation of condensate can lead to the faulty functioning of the meter. In this event, wait until the temperature of the meter reaches room temperature before putting the meter back into operation.

Caution

The meter is only allowed to be opened by authorized personnel.



Safe operation

If safe operation is no longer possible, the meter must be taken out of service and secured against inadvertent operation!

Safe operation is no longer possible if the meter:

- has been damaged in transport
- has been stored under adverse conditions for a lengthy period of time
- is visibly damaged
- no longer operates as described in this manual.

If you are in any doubt, please contact the supplier of the meter.

Obligations of the purchaser

The purchaser of this meter must ensure that the following laws and guidelines are observed when using dangerous substances:

- EEC directives for protective labor legislation
- National protective labor legislation
- Safety regulations
- Safety datasheets of the chemical manufacturers.

**Caution**

In addition to the safety instructions mentioned here, also follow the safety instructions of the sensors used. The operating manuals of the sensors are available on the supplied CD and on the Internet under www.WTW.com.

DOMINIQUE DUTSCHER SAS

3 Commissioning

3.1 Scope of delivery

- Conductivity meter Cond 3110
- 4 batteries 1.5 V Mignon type AA
- Short instructions
- CD-ROM with detailed operating manual

3.2 Initial commissioning

Perform the following activities:

- Insert the supplied batteries
- Switch on the meter.

3.2.1 Inserting the batteries

1	Unscrew the two screws (1) on the underside of the meter.
2	Open the battery compartment (2) on the underside of the meter.

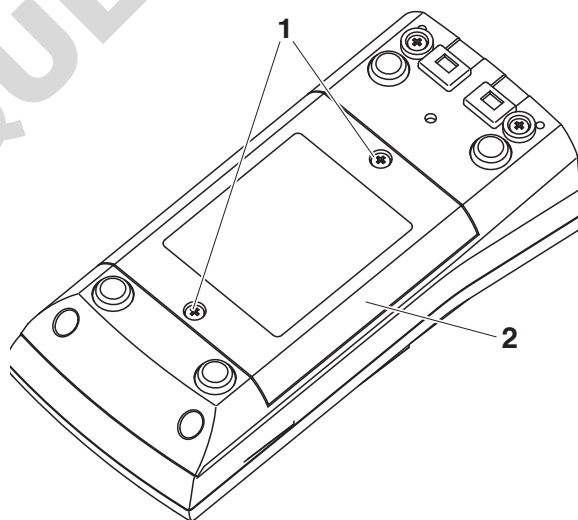

3	Place four batteries (type Mignon AA) in the battery compartment.
---	---



Note

Alternatively, you can also use Ni-MH rechargeable batteries (type

Mignon AA). In order to charge the batteries, an external charging device is required.

**Caution**

Make sure that the poles of the batteries are the right way round. The ± signs on the batteries must correspond to the ± signs in the battery compartment.

- 4 Close the battery compartment (2) and tighten the screws (1).

3.2.2 Switching on the meter

- 1 Press the <On/Off> key.
A display test is briefly displayed.
Subsequently, the meter switches to the measuring mode (measured value display).

**Note**

The meter has an energy saving feature to avoid unnecessary battery depletion during battery operation.

The energy saving feature switches off the meter if no key was pressed during the specified interval (setting the switch-off interval see section 4.5.1).

4 Operation

4.1 General operating principles

This section contains basic information on the operation of the Cond 3110.

4.1.1 Operating modes

The meter has the following operating modes:

- Measurement
The display indicates the measurement data in the measured value display
- Calibration
The display guides you through a calibration procedure with calibration information
- Configuration
The system menu or a sensor menu with submenus, settings and functions is displayed

4.1.2 Operation

Keys The meter is operated via keys. The keys can have different functions with long or short keystrokes.

Functions Generally, with a short keystroke a function is carried out. A long keystroke opens a setting menu.

In a setting menu, settings are selected with the <>< > keys. A setting is confirmed with <ENTER>. With confirming, the setting is finished and the next setting is displayed.

Representation In this operating manual, keys are indicated by brackets <..>. The key symbol (e.g. <ENTER>) generally indicates a short keystroke (under 2 sec) in this operating manual. A long keystroke (approx. 2 sec) is indicated by the underscore behind the key symbol (e.g. <ENTER__>).

4.2 Measuring

Preparatory activities

Perform the following preparatory activities when you want to measure:

1	Connect a measuring cell to the meter.
2	Calibrate or check the meter with the measuring cell.
3	Select the measured parameter with <M>.

Stability control AutoRead

During the measuring procedure, the stability control function is automatically activated. The stability has a considerable effect on the reproducibility of the measured value.

The Stability control function checks whether the measured values are stable within the monitored time interval.

Measured parameter	Time interval	Stability in the time interval
Conductivity χ	10 seconds	Δ : Better than 1.0% of measured value
Temperature	15 seconds	Δ : Better than 0.5 °C

The minimum duration until a measured value is assessed as stable is the monitored time interval. The actual duration is mostly longer.

Temperature sensor

The temperature measurement is absolutely essential for a reproducible conductivity measurement. If a temperature sensor is integrated in the sensor, it is indicated on the display by TP.



Note

The conductivity meter automatically recognizes the type of the temperature sensor used. Therefore, you can connect measuring cells with an NTC30 or Pt1000.

4.2.1 Measuring the conductivity

1	Perform the preparatory activities according to section 4.2.
2	Immerse the conductivity measuring cell in the test sample.
3	If necessary, scroll with <M> until the measured parameter χ with the unit mS/cm or μ S/cm is displayed.
4	Wait for a stable measured value. The AR display indicator flashes as long as the measured value is not yet stable.

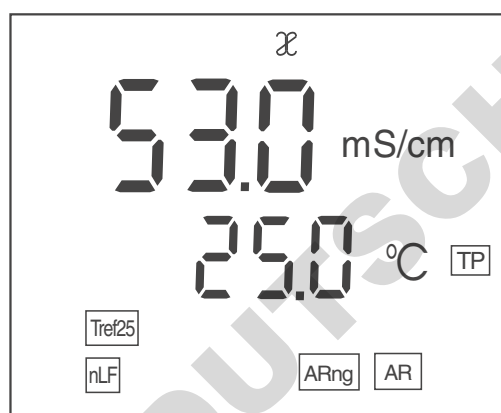

4.2.2 Measuring the salinity

1	Perform the preparatory activities according to section 4.2.
2	Immerse the conductivity measuring cell in the test sample.
3	Using <M>, scroll as necessary until the measured parameter Sal is displayed.
4	Wait for a stable measured value. The AR display indicator flashes as long as the measured value is not yet stable.

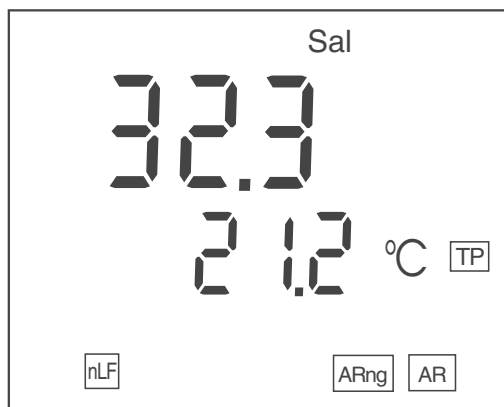

DOMINIQUE DUTSCHER SAS

4.3 Determining/setting up the cell constant [C]

Why determine/set up the cell constant?

Due to aging, the cell constant slightly changes. As a result, an inexact measured value is displayed. Calibration determines the current value of the cell constant and stores this value in the meter. Thus, you should calibrate at regular intervals.

You can either determine the cell constant of the conductivity measuring cell in the range 0.450 ... 0.500 cm⁻¹ or 0.800 ... 0.880 cm⁻¹ by calibration in the control standard 0.01 mol/l KCl, or adjust it manually in the range 0.800 ... 0.880 cm⁻¹. Besides, the fixed cell constant 0.475 cm⁻¹ can be selected.

Cleaning interval (*Int.C*)

After the adjusted cleaning interval has expired the sensor symbol flashes and thus reminds you to clean the measuring cell. It is still possible to measure.

The cleaning interval (*Int.C*) is set to 180 days (d180) in the factory. You can change the interval (see section 4.5.2).



Note

In order to maintain the high measurement accuracy of the measuring system, clean the measuring cell and recalibrate after the cleaning interval has expired.

4.3.1 Determining the cell constant (calibration)

Determining the cell constant (calibration in control standard)

1 Press <CAL> repeatedly until *CAL CELL* is displayed.



2 Press <ENTER> or <CAL__> to confirm the selection of *CAL CELL*.
The cell constant of the last calibration is displayed.

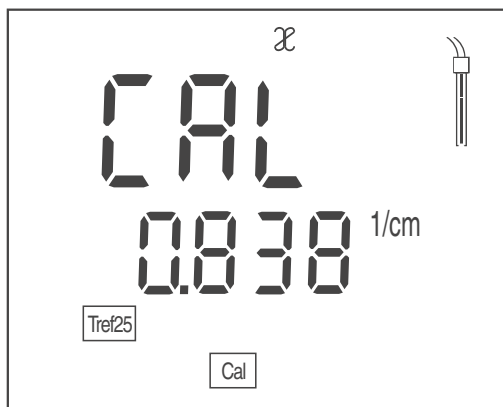

- 3 Immerse the measuring cell in the control standard solution, 0.01 mol/l KCl.
- 4 Start the calibration with **<ENTER>**. The determination of the cell constant with stability control starts. The **AR** display indicator flashes until there is a stable signal. The cell constant determined is displayed. The meter automatically stores the cell constant.

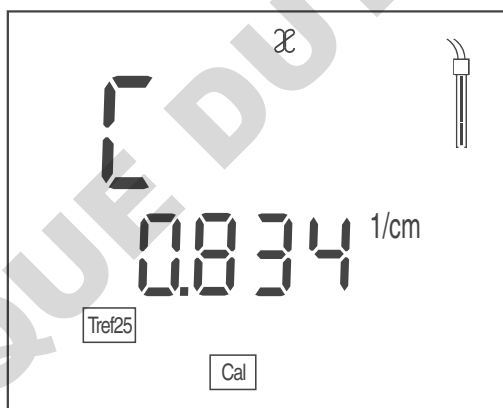

- 5 Switch to the measuring mode with **<ENTER>**. The determined cell constant is used.



Stability control

Note

If the error message *E3* appears, refer to chapter 6 WHAT TO DO IF...

During calibration, the stability control is automatically activated.



Note

This method of automatically determining the cell constant by calibration in the 0.01 mol/l KCL control standard solution can only be used for measuring cells with cell constants in the range 0.450 ... 0.500 cm^{-1} or 0.800 ... 0.880 cm^{-1} .

Calibration evaluation

After the calibration, the meter automatically evaluates the current status. The evaluation appears on the display.

Display	Cell constant [cm ⁻¹]
 You are working with a correctly calibrated measuring cell.	in the range 0.450 ... 0.500 cm ⁻¹ 0.800 ... 0.880 cm ⁻¹
E3 Eliminate the error according to chapter 6 WHAT TO DO IF...	outside the ranges 0.450 ... 0.500 cm ⁻¹ or 0.800 ... 0.880 cm ⁻¹

Downloading calibration data

You can download the calibration data.

- 1 Press <CAL__> to display the calibration data. The calibrated cell constant is displayed.

4.3.2 Using the last calibrated cell constant

Precondition

A valid calibration must be available (see section 4.3.1).

- 1 Press <CAL> repeatedly until *USE CELL* is displayed.



- 2 Press <ENTER> or <CAL__> to confirm the selection of *USE CELL*.

- If necessary, press **<CAL>** repeatedly until *CAL* and the last calibrated cell constant is displayed.

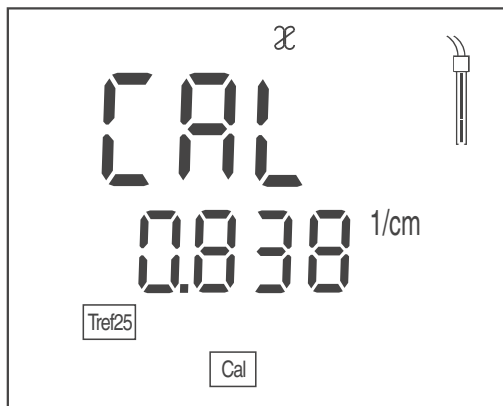

- Confirm the selection with **<ENTER>**.
The displayed cell constant is used.
The meter switches to the measured value display.

4.3.3 Setting the cell constant manually



Note

The cell constant to be set must either be taken from the operating manual of the measuring cell or is printed on the measuring cell.

Range
0.800 ... 0.880 cm⁻¹

- Press **<CAL>** repeatedly until *USE CELL* is displayed.



- Confirm the selection with **<ENTER>** or **<CAL__>**.
The cell constant that was set last is displayed.
- If necessary, press **<CAL>** repeatedly until a cell constant in the range 0.800 ... 0.880 cm⁻¹ is displayed.

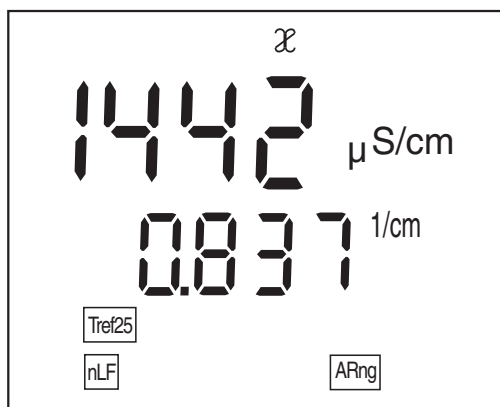

- 4 Set the cell constant to be used with $\langle \rangle \langle \rangle$, e.g. 0.846 cm^{-1} .

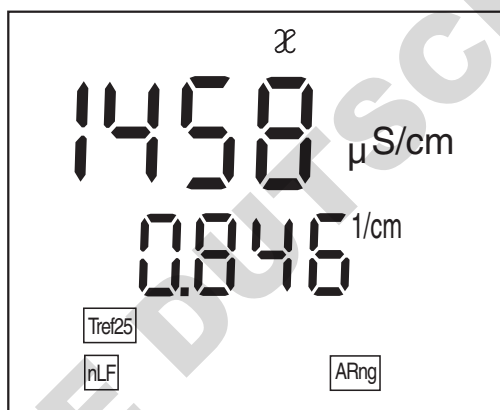

- 5 Confirm the selection with **<ENTER>**.
The new cell constant is used from now on.
The meter switches to the measured value display.

Selecting the cell
constant
 0.475 cm^{-1}

- 1 Press the **<CAL>** key repeatedly until *USE CELL* is displayed.



- 2 Confirm the selection with **<ENTER>** or **<CAL__>**.
- 3 If necessary, press **<CAL>** repeatedly until the cell constant 0.475 cm^{-1} is displayed.

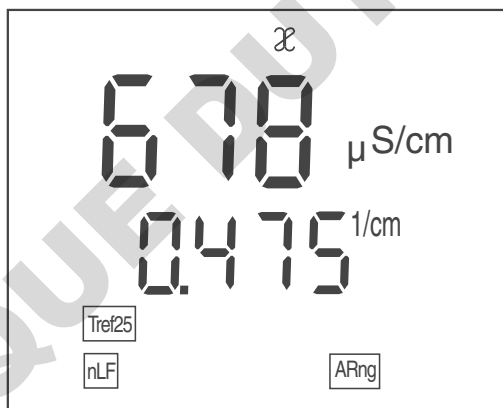

- 4 Confirm the selection with **<ENTER>**.
The meter switches to the measured value display.

4.4 Temperature compensation TC

The calculation of the temperature compensation is based on the preset reference temperature, Tref 20 or Tref 25 (see section 4.5 SETTINGS).

As the temperature compensation, the nonlinear temperature compensation "nLF" according to DIN 38404 or EN 27 888 respectively is permanently set.

Application ranges	Test sample	Temperature compensation TC	Display indicator
	Natural water (ground water, surface water, drinking water)	nLF according to DIN 38404 EN 27 888	nLF
	Ultrapure water	nLF according to DIN 38404 EN 27 888	nLF
	Salinity (seawater)	Automatically nLF according to IOT	Sal, nLF

4.5 Settings

You can adapt the meter to your individual requirements. The settings are done in the following menus:

- System settings (<ENTER__>)
 - Switch-off interval (*tOff*)
- Measurement settings (<M__>)
 - Reference temperature (*Tref25* or *Tref20*)
 - Temperature unit (°C / °F)
 - Cleaning interval (*Int.C* [0 ... 999])



Note

You can exit the setting menu at any time by pressing <M>. Settings already modified and confirmed with <ENTER> are stored.

4.5.1 System settings

The default setting is printed in bold.

Switch-off interval (<i>.OFF</i>)	10, 20, 30, 40, 50 min, 1 , 2, 3, 4, 5, 10, 15, 20, 24 h
-------------------------------------	--

1	Open the menu for system settings with <ENTER__>. The first system setting is displayed.
---	--

Switch-off interval
(*.OFF*)



2	Set the switch-off interval with <>>>.
---	--

3	Confirm with <ENTER>. The system settings are completed. The meter switches to the measuring mode.
---	--

4.5.2 Measurement settings

These settings apply to the determination of the cell constant and measurement (the default condition is printed in bold).

Reference temperature	t25 , t20
Temperature unit (<i>Uni</i>)	°C, °F
Cleaning interval (<i>Int.C</i>)	0 ... 180 ... 999 d

Reference temperature

- 1 Open the menu for measurement settings with <M__>. **t25**, the adjusted reference temperature is displayed.

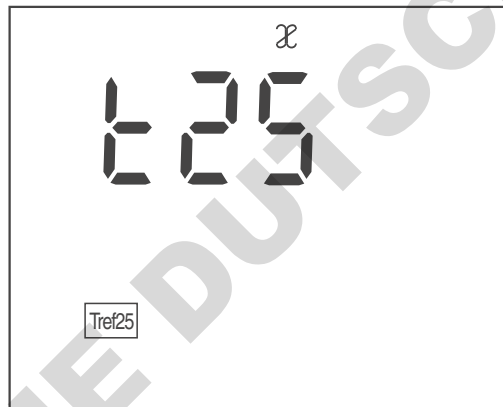

- 2 Select the reference temperature with <>>< .
- 3 Confirm with <ENTER>. **Uni**, the setting of the unit of the temperature value is displayed.

Temperature unit (*Uni*)

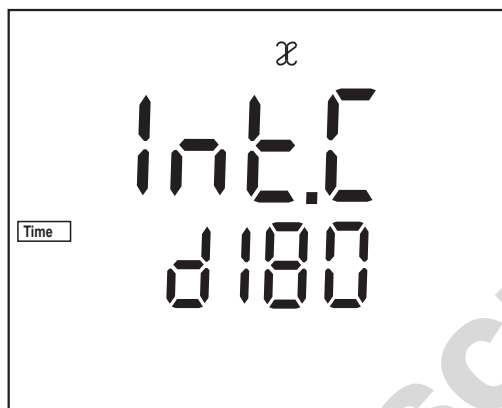

- | | |
|---|--|
| 4 | Using <><>, toggle between °C and °F. |
| 5 | Confirm with <ENTER>.
<i>Int.C</i> , the setting of the cleaning interval is displayed. |

Cleaning interval (*Int.C*)

- | | |
|---|---|
| 6 | Set the interval with <><>. |
| 7 | Confirm with <ENTER>.
The measurement settings are completed.
The meter switches to the measuring mode. |

4.6 Reset

4.6.1 Resetting the cell constant

This function serves to erase the last determined cell constant. Subsequently, the meter uses the last manually set cell constant in the range $0.800 \dots 0.880 \text{ cm}^{-1}$ or the fixed cell constant, 0.475 cm^{-1} .

Based on the last erased cell constant the meter decides to which of the two manually set cell constants the cell constant is reset.

If the erased cell constant was in the calibration range $0.450 \dots 0.500 \text{ cm}^{-1}$, the fixed cell constant 0.475 cm^{-1} is used.

If the erased cell constant was in the calibration range $0.800 \dots 0.880 \text{ cm}^{-1}$, the adjusted cell constant from the range $0.800 \dots 0.880 \text{ cm}^{-1}$ is used.

All other meter settings are retained.



Note

The measuring system is possibly not calibrated after a reset. Before measuring, make sure the meter uses the cell constant suitable for the measuring cell.

Resetting the cell constant

- 1 Press **<On/Off _>** to open the menu for the reset of the cell constant.
Ini.C is displayed.

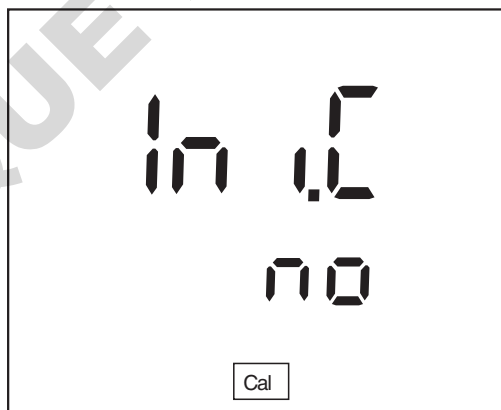

- 2 Press **<>>>** to display *no* or *YES*.
YES: Reset the cell constant.
no: Retain the cell constant.
- 3 Confirm with **<ENTER>**.
The menu is finished.
The meter switches to the measuring mode.

4.6.2 Resetting all meter settings

This function resets all meter settings to the default condition. The relevant values are given in the following sections:

System settings	section 4.5.1
Measurement settings	section 4.5.2

The following settings are also reset to the default condition:

Setting	Default settings
Measured parameter	∞ mS/cm or μ S/cm
Adjusted cell constant	0.840 1/cm

Resetting the meter settings

- 1 Switch on the meter with **<On/Off>**.
The display test appears briefly on the display.
 - 2 During the display test, press **<M>** to open the menu for the reset of the meter settings.
Init is displayed.
- The image shows a rectangular LCD display with a black border. The text 'Init' is displayed in a large, black, 7-segment font at the top. Below it, the text 'no' is displayed in a smaller, black, 7-segment font.
- 3 Press **<>>>** to display *no* or *YES*.
YES: Reset the meter settings.
no: Retain the meter settings.
 - 4 Confirm with **<ENTER>**.
The menu is finished.
The meter switches to the measuring mode.



Note

The measuring system is possibly not calibrated after a reset. Before measuring, make sure the meter uses the cell constant suitable for the measuring cell.

5 Maintenance, cleaning, disposal

5.1 Maintenance

The only maintenance activity required is replacing the batteries.

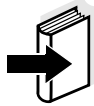

Note

See the relevant operating manuals of the measuring cells for instructions on maintenance.

5.1.1 Replacing the batteries

- | | |
|---|---|
| 1 | Unscrew the two screws (1) on the underside of the meter, |
| 2 | Open the battery compartment (2) on the underside of the meter. |

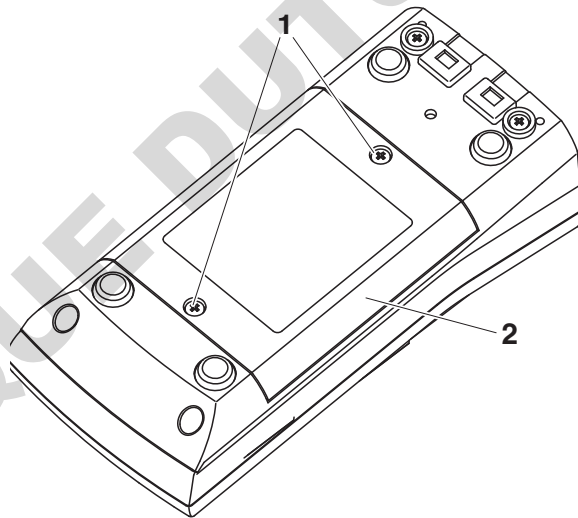

- | | |
|---|---|
| 3 | Remove the four batteries from the battery compartment. |
| 4 | Place four new batteries (type Mignon AA) in the battery compartment. |



Note

Alternatively, you can also use Ni-MH rechargeable batteries (type Mignon AA). In order to charge the batteries, an external charging device is required.

**Caution**

Make sure that the poles of the batteries are the right way round. The \pm signs on the batteries must correspond to the \pm signs in the battery compartment.

- 5 Close the battery compartment (2) and tighten the screws (1).

5.2 Cleaning

Occasionally wipe the outside of the meter with a damp, lint-free cloth. Disinfect the housing with isopropanol as required.

**Caution**

The housing is made of synthetic material (ABS). Thus, avoid contact with acetone or similar detergents that contain solvents. Remove any splashes immediately.

5.3 Packing

This meter is sent out in a protective transport packing. We recommend: Keep the packing material. The original packing protects the meter against damage during transport.

6 What to do if...

Error message <i>OFL, UFL</i>	Cause <ul style="list-style-type: none"> – Measured value outside the measuring range 	Remedy <ul style="list-style-type: none"> – Use suitable measuring cell
Error message, <i>E3</i>	Cause <ul style="list-style-type: none"> – Measuring cell contaminated – Calibration solution not suitable 	Remedy <ul style="list-style-type: none"> – Clean cell and replace it if necessary – Check calibration solutions
Sensor symbol flashes	Cause <ul style="list-style-type: none"> – Cleaning interval expired 	Remedy <ul style="list-style-type: none"> – Recalibrate the measuring system
Display, <i>LoBat</i>	Cause <ul style="list-style-type: none"> – Batteries almost empty 	Remedy <ul style="list-style-type: none"> – Replace the batteries (see section 5.1 MAINTENANCE)
Meter does not react to keystroke	Cause <ul style="list-style-type: none"> – Operating condition undefined or EMC load unallowed 	Remedy <ul style="list-style-type: none"> – Processor reset: Press the <ENTER> and <On/Off> key simultaneously
You want to know which software version is in the meter	Cause <ul style="list-style-type: none"> – E. g., a question by the service department 	Remedy <ul style="list-style-type: none"> – Switch on the meter. During the display test, display the software version with <ENTER>.

DOMINIQUE DUTSCHER SAS

7 Technical data

7.1 General data

Dimensions	approx. 180 x 80 x 55 mm	
Weight	approx. 0.4 kg	
Mechanical structure	Type of protection	IP 67
Electrical safety	Protective class	III
Test certificates	CE	
Ambient conditions	Storage	- 25 °C ... + 65 °C
	Operation	-10 °C ... + 55 °C
	Allowable relative humidity	Annual mean: < 75 % 30 days/year: 95 % Other days: 85 %
Power supply	Batteries	4 x 1.5 V alkali-manganese batteries, type AA
	Rechargeable batteries	4 x 1,2 V NiMH rechargeable batteries, type AA (no charging function)
	Operational life	Approx. 1000 h operating hours (batteries)
Guidelines and norms used	EMC	EC directive 2004/108/EC EN 61326-1 EN 61000-3-2 EN 61000-3-3 FCC Class A
	meter safety	EC directive 2006/95/EC EN 61010-1
	IP protection	EN 60529

7.2 Measuring ranges, resolution, accuracy

Measuring ranges, resolution	Variable	Measuring range	Resolution
	\mathcal{K} [$\mu\text{S}/\text{cm}$]	0.0 ... 199.9	0.1
		200 ... 1999	1
	\mathcal{K} [mS/cm]	2.00 ... 19.99	0.01
		20.0 ... 199.9	0.1
		200 ... 1000	1

Measuring ranges, resolution	Variable	Measuring range	Resolution
	SAL	0.0 ... 70.0 according to the IOT table	0.1
	T [°C]	- 5.0 ... + 105.0	0.1
	T [°F]	+ 23.0 ... + 221.0	0.1

Cell constants	Cell constant C	Values
	Can be calibrated in the ranges	0.450 ... 0.500 cm ⁻¹ 0.800 ... 0.880 cm ⁻¹
	Adjustable	0.800 ... 0.880 cm ⁻¹ 0.475 cm ⁻¹ (fixed)

Reference temperature	Reference temperature	Values
	Adjustable	20 °C (Tref20) 25 °C (Tref25)

Accuracy (± 1 digit)	Variable	Accuracy	Temperature of the test sample
<i>κ</i> / Temperature compensation			
	Nonlinear (nLF)	± 0.5 %	0 °C ... + 35 °C according to EN 27 888
		± 0.5 %	+ 35 °C ... + 50 °C enhanced nLF function
SAL / range			
	0.0 ... 70.0	± 0.1	+ 5 °C ... + 25 °C
		± 0.2	+ 25 °C ... + 30 °C
T [°C] / temperature sensor			
	NTC 30	± 0.1	
	PT 1000	± 0.1	



Note

The accuracy values specified here apply exclusively to the meter. The accuracy of the measuring cell has also to be taken into account.

8 Lists

This chapter provides additional information and orientation aids.

Specialist terms The glossary briefly explains the meaning of the specialist terms. However, terms that should already be familiar to the target group are not described here.

Index The index helps you to find the topics that you are looking for.

Glossary

Adjusting To manipulate a measuring system so that the relevant value (e. g. the displayed value) differs as little as possible from the correct value or a value that is regarded as correct, or that the difference remains within the tolerance.

AutoRange Name of the automatic selection of the measuring range.

Calibration Comparing the value from a measuring system (e. g. the displayed value) to the correct value or a value that is regarded as correct. Often, this expression is also used when the measuring system is adjusted at the same time (see adjusting).

Cell constant, k Characteristic quantity of a conductivity measuring cell, depending on the geometry.

Conductivity Short form of the expression, specific electrical conductivity. It corresponds to the reciprocal value of the resistivity. It is a measured value of the ability of a substance to conduct an electric current. In water analysis, the electrical conductivity is a dimension for the ionized substances in a solution.

Measured parameter The measured parameter is the physical dimension determined by measuring, e. g. pH, conductivity or D.O. concentration.

Measured value The measured value is the special value of a measured parameter to be determined. It is given as a combination of the numerical value and unit (e. g. 3 m; 0.5 s; 5.2 A; 373.15 K).

Molality Molality is the quantity (in Mol) of a dissolved substance in 1000 g solvent.

Reference temperature Fixed temperature value to compare temperature-dependent measured values. For conductivity measurements, the measured value is converted to a conductivity value at a reference temperature of 20 °C or 25 °C.

Reset	Restoring the original condition of all settings of a measuring system.
Resistance	Short name for the specific electrolytic resistance. It corresponds to the reciprocal value of the electrical conductivity.
Resolution	Smallest difference between two measured values that can be displayed by a measuring instrument.
Salinity	The absolute salinity S_A of seawater corresponds to the relationship of the mass of dissolved salts to the mass of the solution (in g/Kg). In practice, this dimension cannot be measured directly. Therefore, the practical salinity according to IOT is used for oceanographic monitoring. It is determined by measuring the electrical conductivity.
Salt content	General designation for the quantity of salt dissolved in water.
Stability control	Function to control the measured value stability.
Standard solution	The standard solution is a solution where the measured value is known by definition. It is used to calibrate a measuring system.
Temperature coefficient	Value of the slope α of a linear temperature function. $\mathcal{X}_{T_{\text{Ref}}} = \mathcal{X}_{\text{Meas}} * \frac{1}{1 + \alpha * (T - T_{\text{Ref}})}$
Temperature compensation	Name of a function that considers the temperature influence on the measurement and converts it accordingly. Depending on the measured parameter to be determined, the temperature compensation functions in different ways. For conductimetric measurements, the measured value is converted to a defined reference temperature. For potentiometric measurements, the slope value is adjusted to the temperature of the test sample but the measured value is not converted.
Temperature function	Name of a mathematical function expressing the temperature behavior of a test sample, a probe or part of a probe.
Test sample	Designation of the test sample ready to be measured. Normally, a test sample is made by processing the original sample. The test sample and original sample are identical if the test sample was not processed.

Index

A

- Authorized use 10
- AutoRead 19

B

- Battery compartment 13, 31

C

- Calibration 19
- Calibration evaluation 21
- Cell constant 19
- Cleaning interval 19
- Copyright 2

D

- Display 7

E

- Energy saving feature 14

I

- Initial commissioning 13, 14
- Interval
 - Calibration 19

K

- Keys 6

L

- LoBat 33

M

- Measurement accuracy 19

N

- Nonlinear
 - Temperature compensation 25

O

- Operational safety 10

P

- Precautions 9

R

- Reset 29
 - All meter settings 30
 - Cell constant 29
- Resolution setting 27

S

- Safety 9
- Scope of delivery 13
- Socket field 8

T

- Temperature compensation 25
 - Nonlinear 25
- Temperature sensor 16

DOMINIQUE DUTSCHER SAS

DOMINIQUE DUTSCHER SAS

Xylem |'zīləm|

- 1) The tissue in plants that brings water upward from the roots;
- 2) a leading global water technology company.

We're a global team unified in a common purpose: creating advanced technology solutions to the world's water challenges. Developing new technologies that will improve the way water is used, conserved, and re-used in the future is central to our work. Our products and services move, treat, analyze, monitor and return water to the environment, in public utility, industrial, residential and commercial building services settings. Xylem also provides a leading portfolio of smart metering, network technologies and advanced analytics solutions for water, electric and gas utilities. In more than 150 countries, we have strong, long-standing relationships with customers who know us for our powerful combination of leading product brands and applications expertise with a strong focus on developing comprehensive, sustainable solutions.

For more information on how Xylem can help you, go to www.xylem.com.



Service and Returns:

Xylem Analytics Germany
Sales GmbH & Co. KG
WTW
Am Achalaich 11
82362 Weilheim
Germany

Tel.: +49 881 183-325

Fax: +49 881 183-414

E-Mail wtw.rma@xylem.com

Internet: www.xylemanalytics.com

xylem
Let's Solve Water

Xylem Analytics Germany GmbH
Am Achalaich 11
82362 Weilheim
Germany

CE

UK
CA