

Valid for Item-No.: 683201, 683271, 683273, 683274, 683275, 683276, 683277

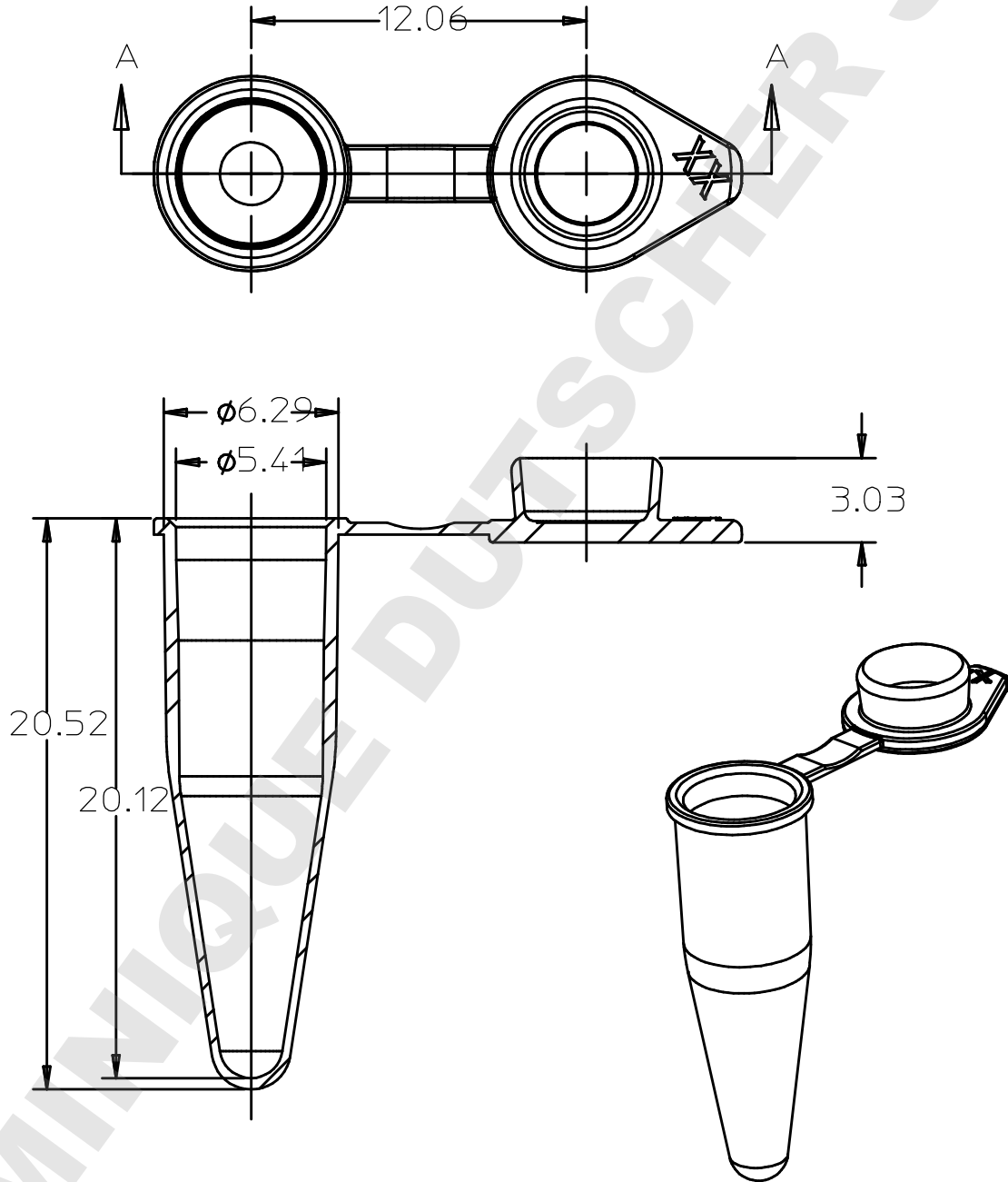

"All dimensions in mm"

Customer drawing subject to change without notice!

Uncontrolled Copy

Prior Issue	Drawn	Approved	Released	CONFIDENTIAL: Information contained in this document or drawing is confidential and proprietary to Greiner Bio-One GmbH. This document may not be reproduced for any reason without written permission from Greiner Bio-One GmbH. All rights of design, invention, and copyright are reserved.
Revision	Date	Date	Date	
2	2011/08/15	2015/11/23	2015/11/23	
Date	Name	Name	Name	
2015/09/16	forb	forb	sonntag	