

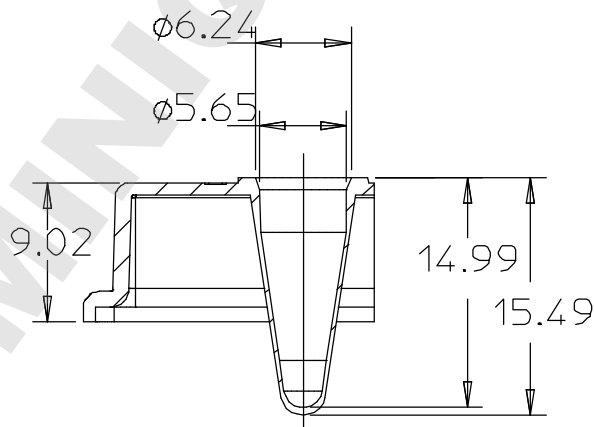

Valid for Item-No.: 669285

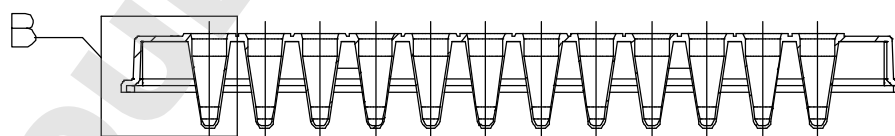
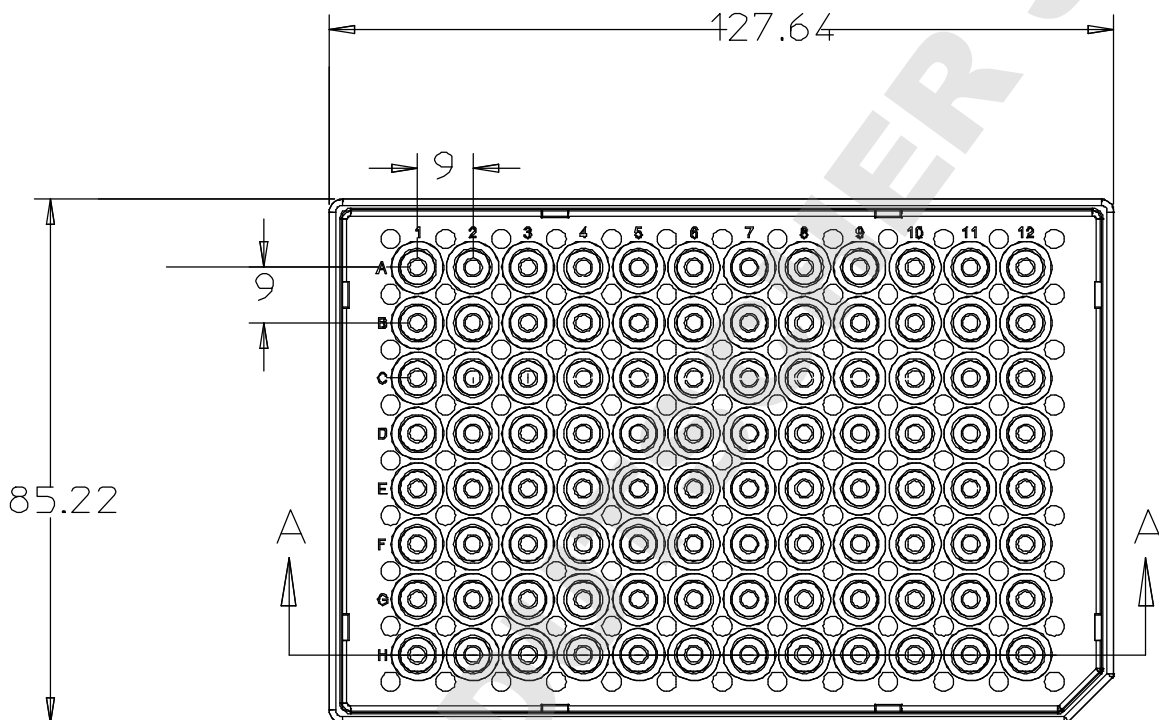

"All dimensions in mm"

Customer drawing subject to change without notice!

Uncontrolled Copy

Prior Issue	Drawn	Approved	Released	CONFIDENTIAL: Information contained in this document or drawing is confidential and property of Greiner Bio-One GmbH. This document may not be reproduced for any reason without written permission from Greiner Bio-One GmbH. All rights of design, invention, and copyright are reserved.
Revision	Date 2015/08/06	Date 2015/08/06	Date 2015/09/16	
Date	Name forb	Name forb	Name sonntag	