

Curvature max.0,2

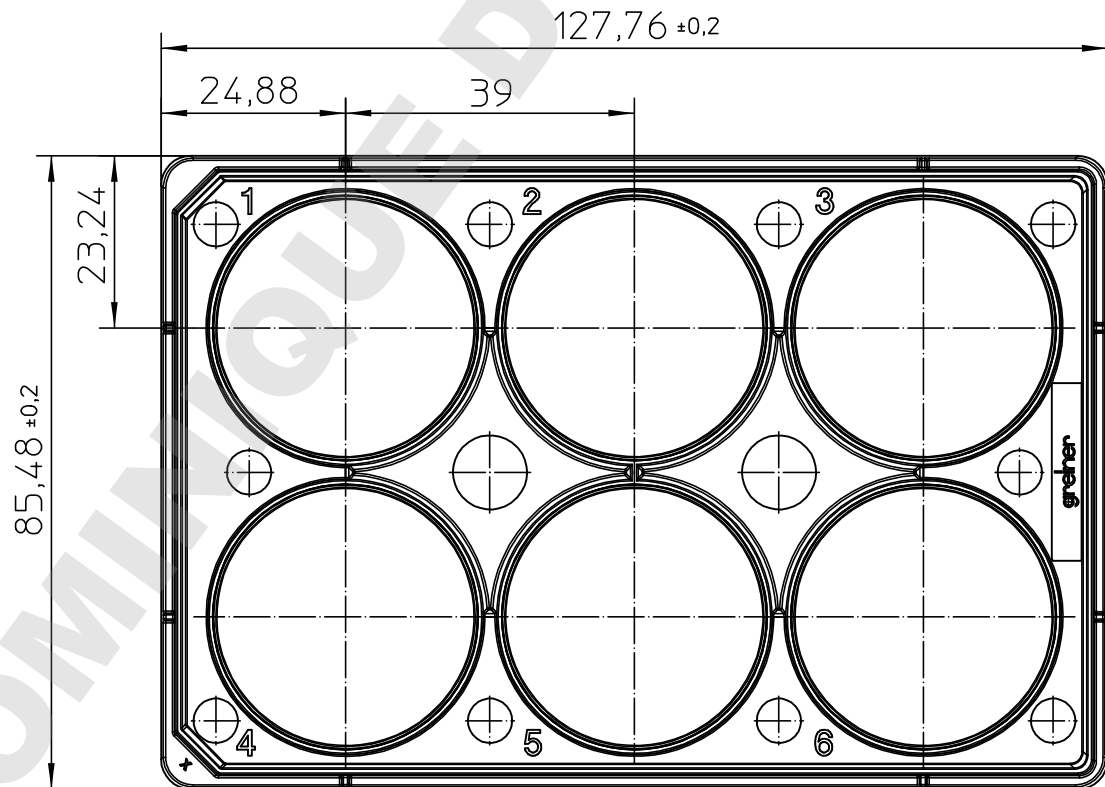
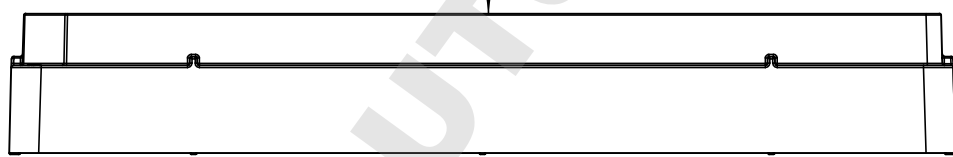

"All dimensions in mm"

Customer drawing subject to change without notice!

Uncontrolled Copy

Prior Issue	Drawn	Approved	Released	<small>CONFIDENTIAL: Information contained in this document or drawing is confidential and proprietary to Greiner Bio-One GmbH. This document may not be reproduced for any reason without written permission from Greiner Bio-One GmbH. All rights of design, invention, and copyright are reserved.</small>
Revision 1	Date 2011/06/22	Date 2015/01/09	Date 2015/01/09	
Date 2011/06/22	Name forb	Name schwarzj	Name sonntag	



Curvature $+0,2$
0

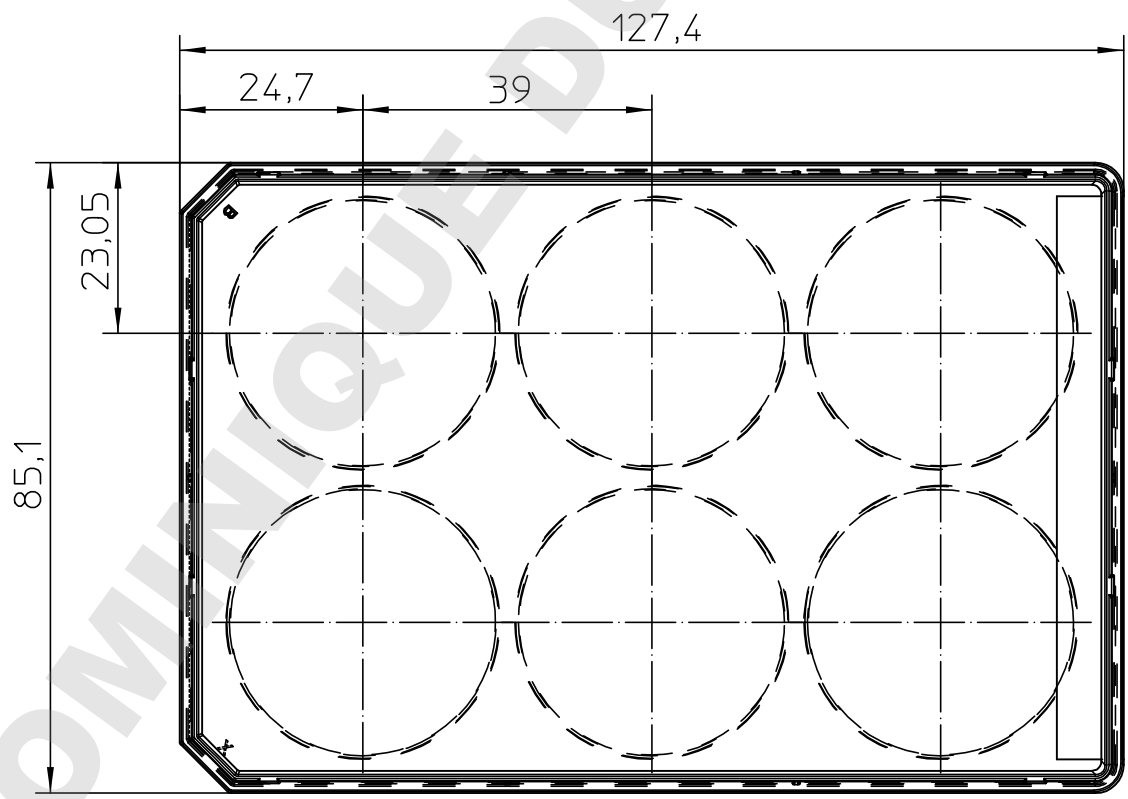
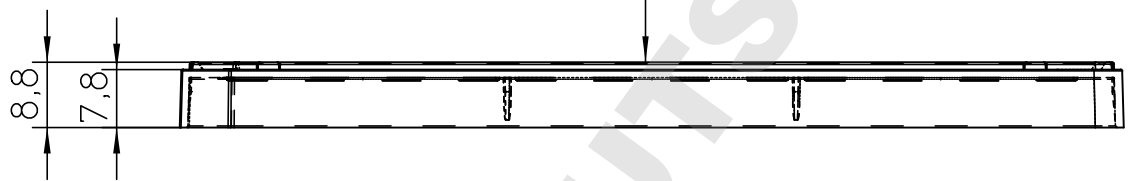

"All dimensions in mm"

Customer drawing subject to change without notice!

Uncontrolled Copy

Prior Issue	Drawn	Approved	Released	<small>CONFIDENTIAL: Information contained in this document or drawing is confidential and proprietary to Greiner Bio-One GmbH. This document may not be reproduced for any reason without written permission from Greiner Bio-One GmbH. All rights of design, invention, and copyright are reserved.</small>
Revision 1	Date 2011/06/22	Date 2015/01/09	Date 2015/01/09	
Date 2011/06/22	Name forb	Name schwarzj	Name sonntag	