

Valid for Item-No.: 639160, 639960

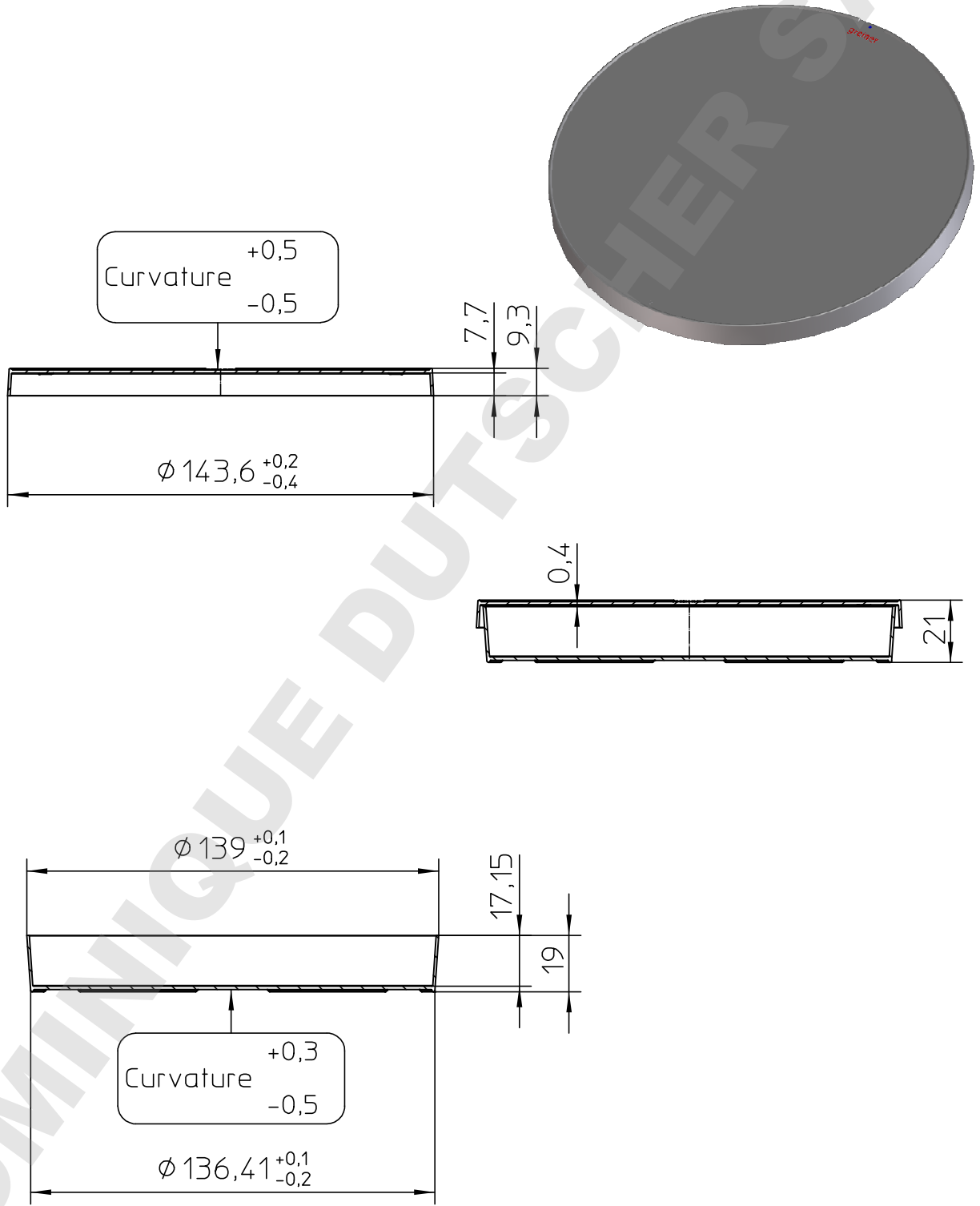

"All dimensions in mm"

Customer drawing subject to change without notice!

Uncontrolled Copy

Prior Issue	Drawn	Approved	Released	<small>CONFIDENTIAL: Information contained in this document or drawing is confidential and proprietary to Greiner Bio-One GmbH. This document may not be reproduced for any reason without written permission from Greiner Bio-One GmbH. All rights of design, invention, and copyright are reserved.</small>
Revision 2	Date 2012/10/11	Date 2015/02/13	Date 2015/02/13	
Date 2012/11/20	Name forb	Name schwarzj	Name sonntag	