

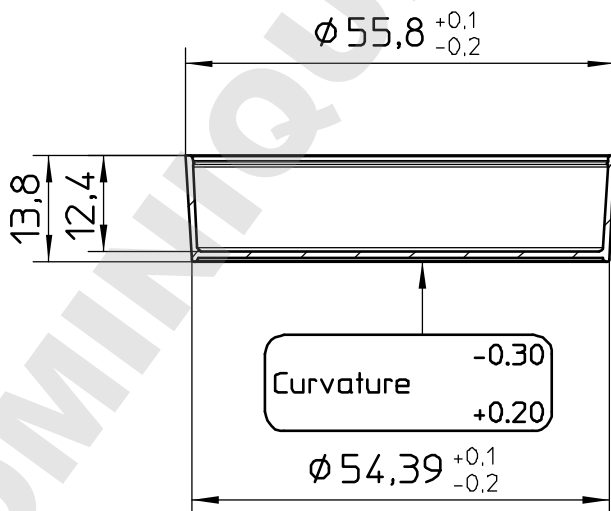

Valid for Item-No.: 628102, 628160, 628160-TRI, 628161

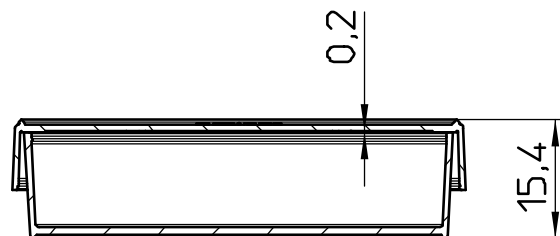
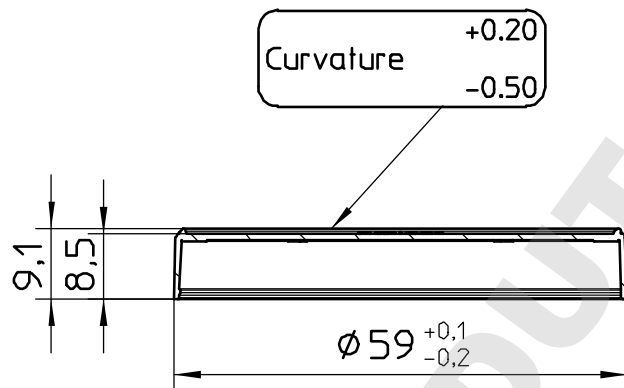

"All dimensions in mm"

Customer drawing subject to change without notice!

Uncontrolled Copy

Prior Issue	Drawn	Approved	Released	CONFIDENTIAL: Information contained in this document or drawing is confidential and proprietary to Greiner Bio-One GmbH. This document may not be reproduced for any reason without written permission from Greiner Bio-One GmbH. All rights of design, invention, and copyright are reserved.
Revision 2	Date 2011/04/01	Date 2017/02/09	Date 2017/02/09	
Date 2015/04/30	Name forb	Name schwarzj	Name sonntag	