

DWG NO: LM31-CUST

NOTES:

1 MATERIAL: POLYPROPYLENE
FDA 21 CFR 177.1500
RoHS COMPLIANT
ANIMAL FREE
USP CLASS VI
COLOR: NATURAL

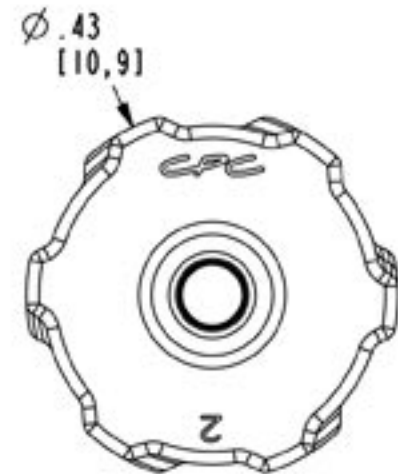
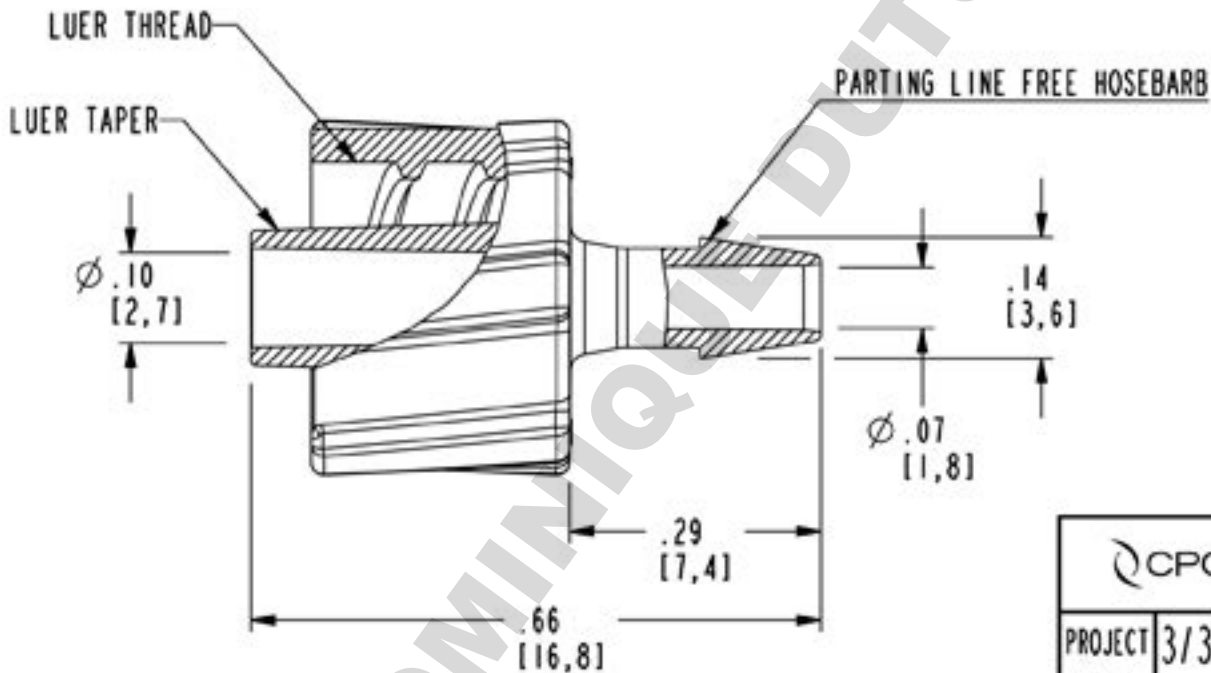

CPC 1 800 444 2474 cpcworldwide.com

PROJECT 3/32 HB MALE LUER INTEGRAL LOCK RING
7362 (CUSTOMER DRAWING)

DWG BY: KRN DATE: 06-30-09 CHKD BY:

MATL/FIN: SEE NOTE 1 DWG NO: LM31-CUST