

Operation Manual

V1.3

Auto-Pure Series Nucleic Acid Purification System

Auto-Pure 24/48/96

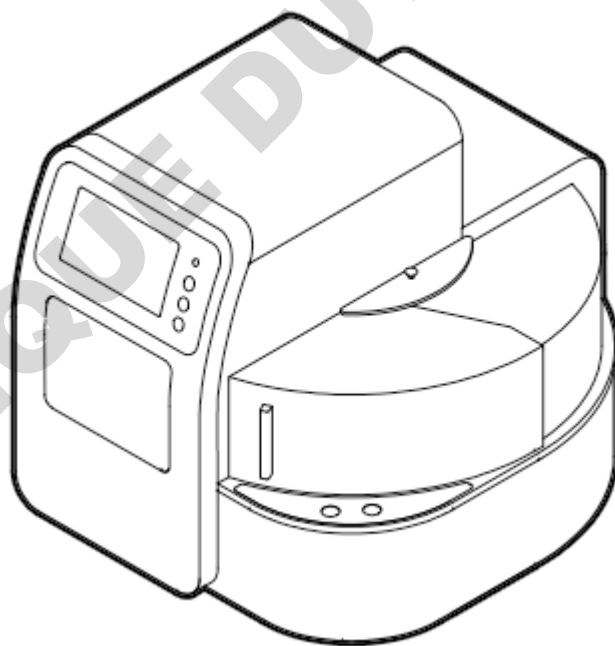

ALLSHENG

Hangzhou Allsheng Instruments Co., Ltd.

Foreword

Thank you for purchasing our Auto-Pure series Nucleic Acid Purification System. This Manual describes the function and operation of the instrument. In order to use the instrument properly, please read this manual carefully before using. Keep it for later use when you meet with difficulties.

Opening Check

Please check the Instrument and Accessories according to the packing list when you first open the packing case. If anything wrong or missing, please contact the distributor or the manufacturer.

HANGZHOU ALLSHENG INSTRUMENTS CO., LTD.

Add: Building 1 & 2, Zheheng Science Park, Zhuantang Town, Xihu

District, Hangzhou, Zhejiang 310024, China

Tel.: 0086-0571-89948289

Fax: 0086-0571-87205673

Website: www.allsheng.com

E-mail: info@allsheng.com

File No.: AS180SM

Version No.: V1.3, Jul. 2020

Safety Warnings and Guidelines

1. Important information for safe use

Users should have a clear understanding of how to use this instrument before operation, please read this manual carefully prior to operation.



Any improper operation may cause injured or electric shock. Please read the manual carefully and operate safely according to the guidelines.

2. Security

The operation and maintenance and of the instrument should comply with the basic guidelines and warnings below. Incorrect operation or maintenance will have effect on using life, performance, and safety features of the instrument.



The instrument is normal indoor instrument which conforms to class I of GB 4793.1 standard.



Please read this manual carefully before operation. The device must be used by experienced personnel with appropriate training.



The operator should not repair the instrument in case any injury or out-of warranty. If service required, please contact Allsheng or your local distributor for repair.



Before powering on, please make sure the voltage of the power supply is consistent with the required voltage. And make sure the rated load of the power outlet is not less than required by the instrument.

If the power cord is damaged, replace it with the same type and specification power cord. Do not cover anything on the instruments when using. Insert and pull the power line with hand gently and make sure the plug completely insert to the jack.



The temperature of the heating block is high, please do not touch it during the operation in case any injury.



The instrument should be kept in an area with minimal dust, away from wet areas and direct sunlight. In addition, the installation location should have sufficient ventilation, but away from electromagnetic interference and heat sources. The vents on this instrument are designed for ventilation. Do not cover them in case of overheating. When many instruments are used at the same time, the distance between each instrument should be more than 100cm.



Power off when not in use. If the instrument will not be used for a long period of time, cover it with a cloth or plastic to protect it from dust.

Disconnect the power cord from the jack at once in the following cases, and contact your local distributor or Allsheng:



- Liquid enters into the Instrument;
- Instrument was rained or watered.
- Abnormal operation: such as abnormal sound or smell.
- Instrument dropping or outer shell damaged.
- The function has obviously changed.

Indicates disposal instruction.



DO NOT throw this unit into a municipal trash bin when this unit has reached the end of its lifetime. To ensure the utmost protection of the global environment and minimize pollution, please recycle this unit.

3. Maintenance

The instrument should be cleaned regularly using a soft cloth damp with a small amount of alcohol. If any stain on the surface of the instrument, wipe it with a soft cloth damp with cleansing cream.

4. Transportation and storage requirements

Ambient temperature: 10°C ~ 35°C

Relative humidity: ≤70%

Atmosphere pressure range: 500 ~ 1060hpa

Locate it in a well-ventilated room, away from corrosive gas.

DOMINIQUE DUTSCHER SAS

Contents

Chapter 1 Introduction	1
1. Application.....	1
2. Contraindication.....	1
3. Service Life.....	1
Chapter 2 Specifications	2
1. Working Conditions.....	2
2. Basic Parameters.....	2
3. Overall Dimensions.....	3
Chapter 3 Basic Operating Instructions	4
1. Structures.....	4
2. Touch Screen.....	6
Chapter 4 Operations	7
1. Power Connection.....	7
2. Kits Installation.....	7
3. Detailed Operations.....	8
3.1. Start-up Interface.....	8
3.2. Run Program Interface.....	8
3.3. Manage Program.....	15
3.4. System Settings.....	19
3.5. UV Sterilization.....	25
3.6. Help.....	26
Chapter 5 Trouble Shooting	27
1. Troubleshootings.....	27
2. Software Error Alarm List.....	28
Chapter 6 Accessory	29
Chapter 7 Abbreviations and Tags	30
1. Abbreviations.....	30
2. Tags.....	31

Chapter 1 Introduction

Auto-Pure 24/48/96 nucleic acid purification instrument is a newly launched automatic extraction and purification system for DNA/RNA, proteins and cells. It can absorb, transfer and release magnetic beads by magnetic rod and magnetic rod sleeve to separate magnetic beads and samples. The operation is automatic, fast and simple. Users can extract 1~24, 1~48 or 1~96 samples simultaneously with special kits. Auto pure series can extract samples of animal/plant tissue, blood and body fluids, etc with different kinds of magnetic bead nucleic acid extraction reagents. It is mainly used for the extraction and purification of nucleic acid from human body samples.

1. Application

This instrument is suitable for the extraction and purification of nucleic acids in animal and plant tissues, blood and body fluids and other samples(mainly used in human body samples).

2. Contraindication

No contraindication.

3. Service Life

Service life of the instrument is five years.

For production date, please see the label on back of the instrument.

Chapter 2 Specifications

1. Working Conditions

Environmental Temperature: 10°C~35°C

Relative Humidity: ≤70%

Input Voltage: AC 100~240V, 50Hz/60Hz

2. Basic Parameters

Model Parameters	Auto-Pure 24	Auto-Pure 48	Auto-Pure 96
Principle	Magnetic Particle Method, Magnet type		
Sample Volume	200μL-10000μL	50μL-3000μL	50μL—1000μL
Throughput	24	48	96
Stability	CV≤5%		
Extraction time	10 ~ 60min/time		
Temperature control module	Ambient temperature ~ 120°C for lysis and elution		
Heating time	Heating time (Ambient temperature ~120°C) ≤7 minutes		
Temp. Accuracy	±1°C		
Vibrate and mix	10 different speeds for option		
Operation	7 inch color touch screen, mouse can be connected		
Programs	8 groups of programs can be preset, and can store 100 groups of programs		
Program management	Including create, edit, delete and protocol mode		
Extension interface	With USB port and Ethernet port		
Network	Extended Ethernet remote control, WiFi function, 4G		
Power Supply	AC100-240V, 50Hz/60Hz, 450VA		

3. Overall Dimensions

Unit: mm

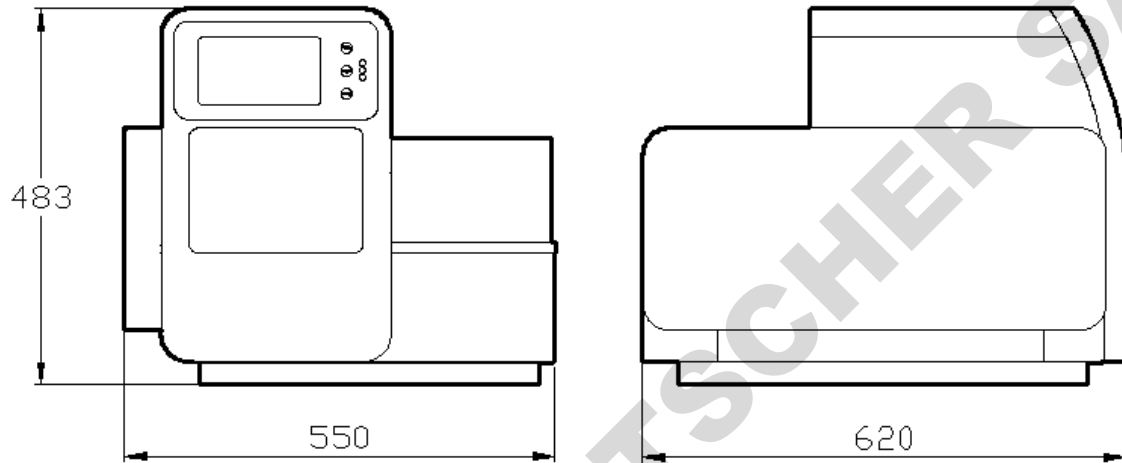

Fig 1

Chapter 3 Basic Operating Instructions

This chapter mainly introduces structures, basic operation keys, displays, as well as preparations before starting up. Please read this chapter carefully before using this instrument.

1. Structures

1.1. Front

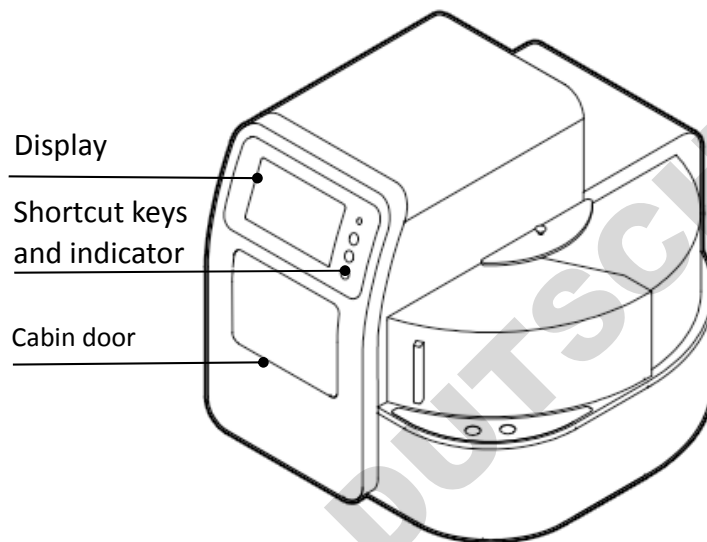

Fig 2

1.2. Back

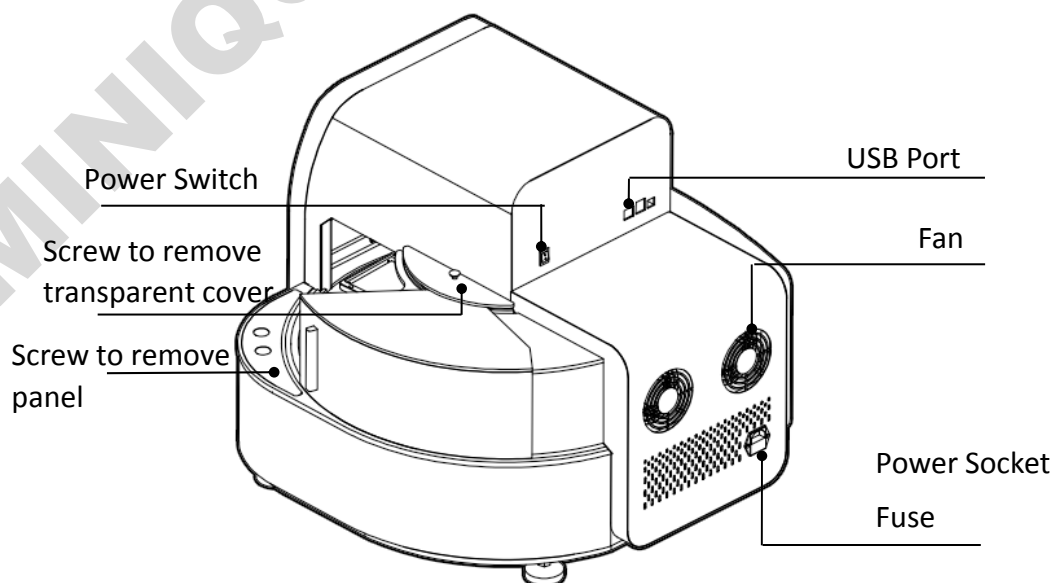

Fig 3

1.3. Cabin Door

The cabin door of Auto-Pure 24/48/96 can be opened which is convenient for cleaning and maintenance.

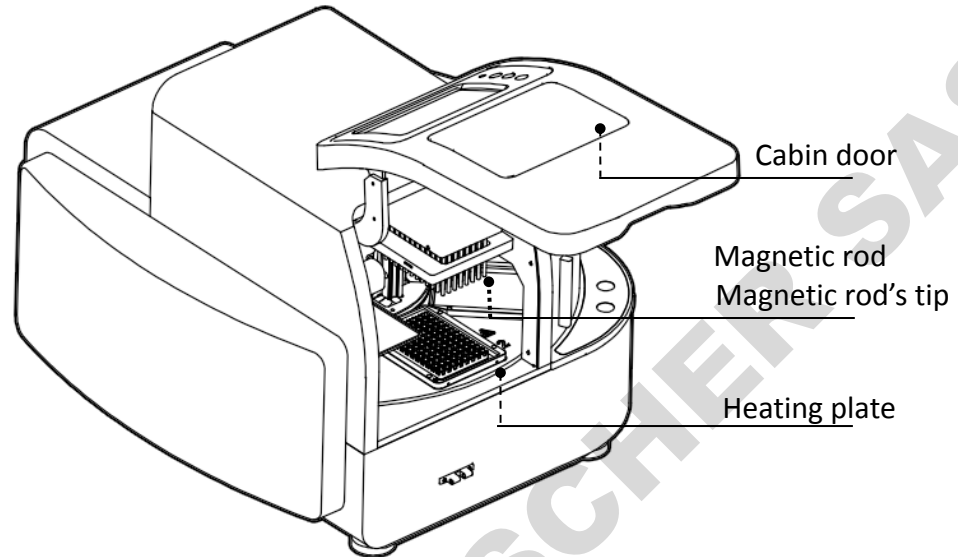

Fig 4

1.4. Transparent Cover

The transparent cover is on the right side of the instrument which is for placing or taking out kits.

The cover can be removed which makes it convenient matching with automatic liquid transfer workstation.

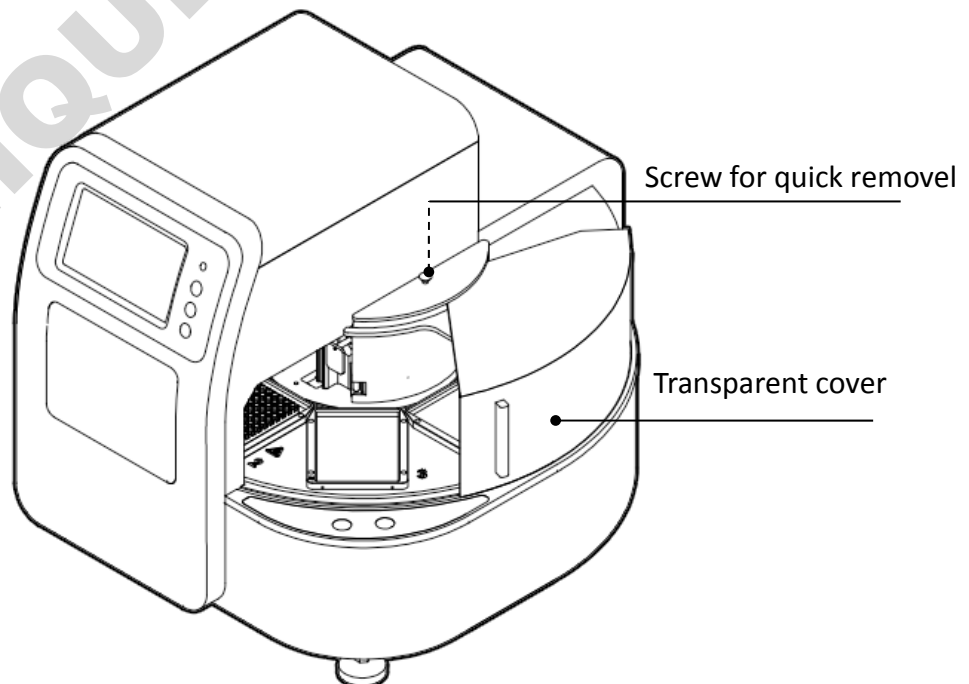

Fig 5

2. Touch Screen

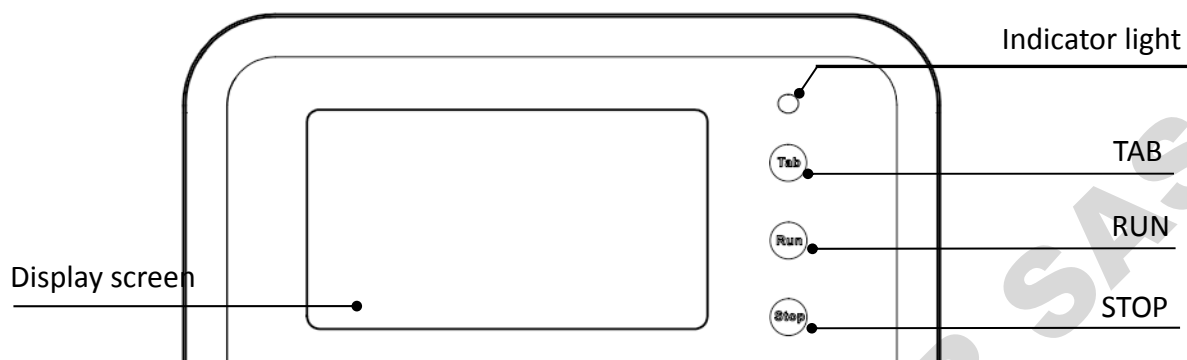

Fig 6

Display screen: Touch screen, mouse also can be connected for operation.

TAB: Select shortcut program.

RUN: Start the shortcut program and run the instrument.

STOP: Stop the operation.

Chapter 4 Operations

1. Power Connection

AC 100 ~ 240V

2. Kits Installation

Open the cabin door, put kits on the plate position of the rotary table, press position button to turn the rotary table and place all the kits in turn. Auto- pure24/48/96 are suitable for 24-well kit, 48-well kit and 96-well kit separately.

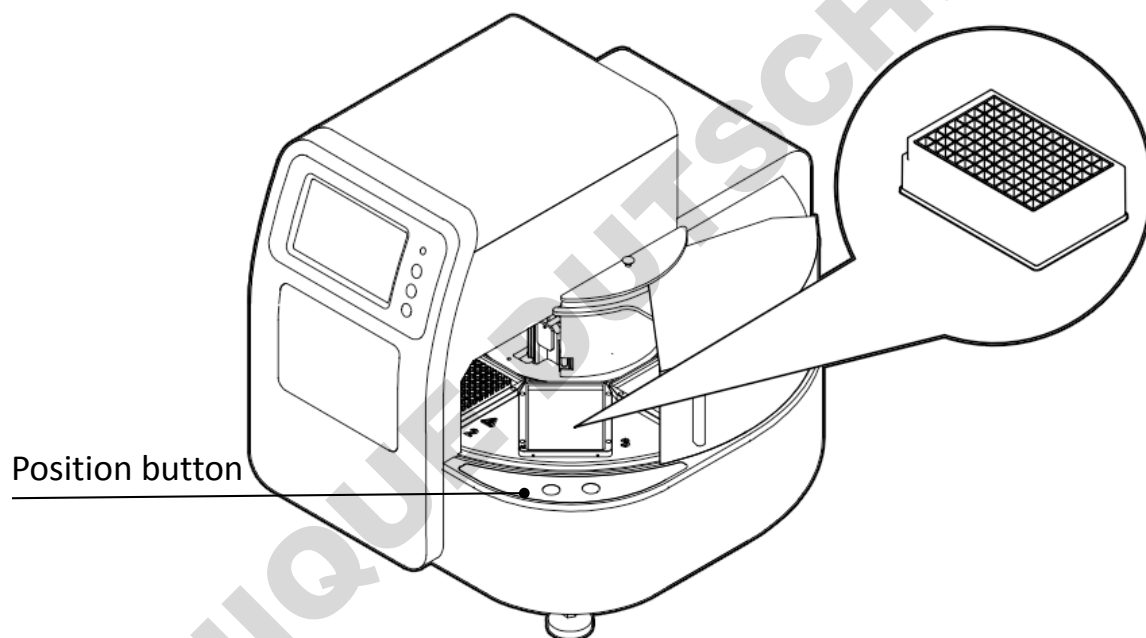

Fig 7

3. Detailed Operations

3.1. Start-up Interface

Turn on the instrument and make sure the door is closed before start, start-up interface will comes up.



Fig 8

Then, it will enter into “Run Prog.” interface.

3.2. Run Program Interface

This interface including two modes: “shortcut” mode and “list mode”, as shown in below Fig 9 and Fig 10.



Fig 9

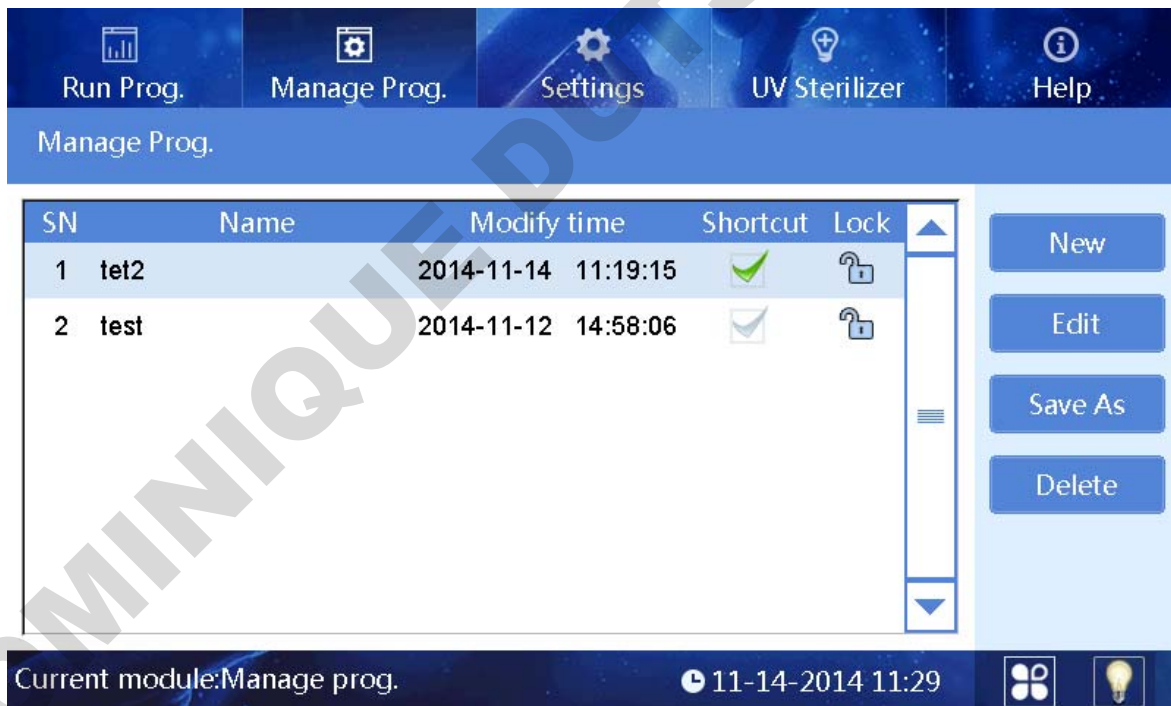

Fig 10

In the “List mode” interface, if one program selected/activated in “Shortcut” column, the icon of the program can be displayed on shortcut interface. 8pcs of programs can be activated in maximum at the same time.

“SN”, “Name”, “Modify time” and “Lock” are non-editable options.

3.2.1. Run Interface

In “List mode” or “Shortcut” mode, select required program and click “Run” to enter into run interface.

When running the program, the instrument will first detect the presence of the kit on the rotary table. If no kit is found on the board of the setup program, the program will prompt to confirm whether the following steps can be continued, as shown in the figure below.



Fig 11

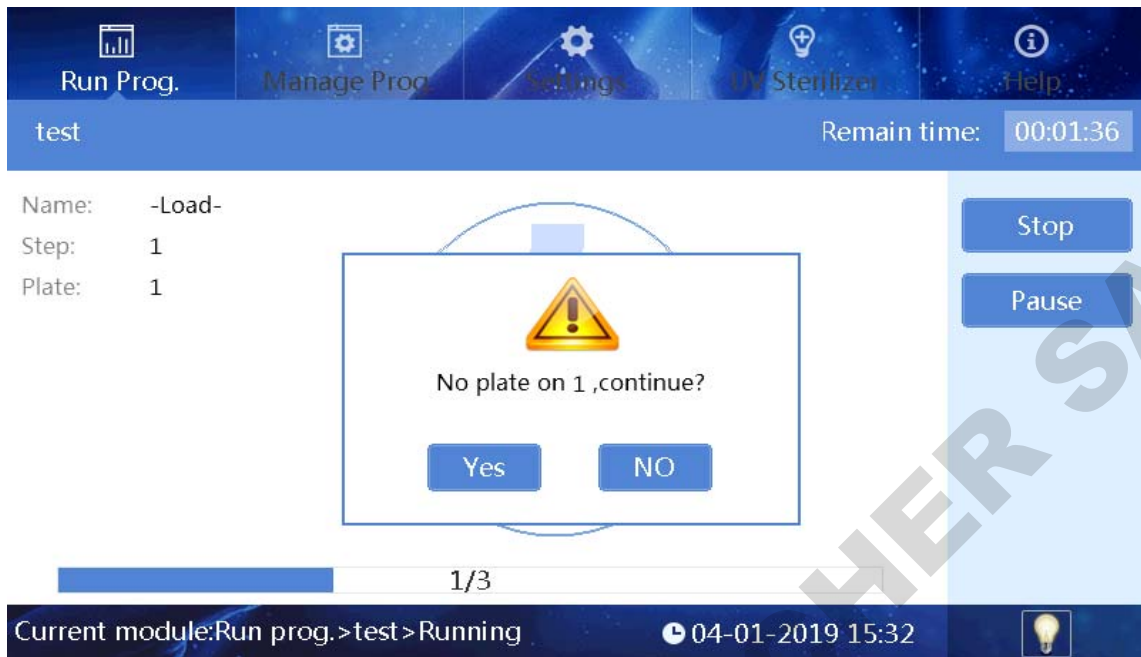

Fig 12

The instrument will install magnetic rod sleeve automatically. If rod sleeves are already installed on the current magnetic rod sleeve rack, "Sleeve loaded, continue?" will pop up. If no magnetic rod sleeve is detected after installing the magnetic rod sleeve, "No sleeve, continue?" will appear.

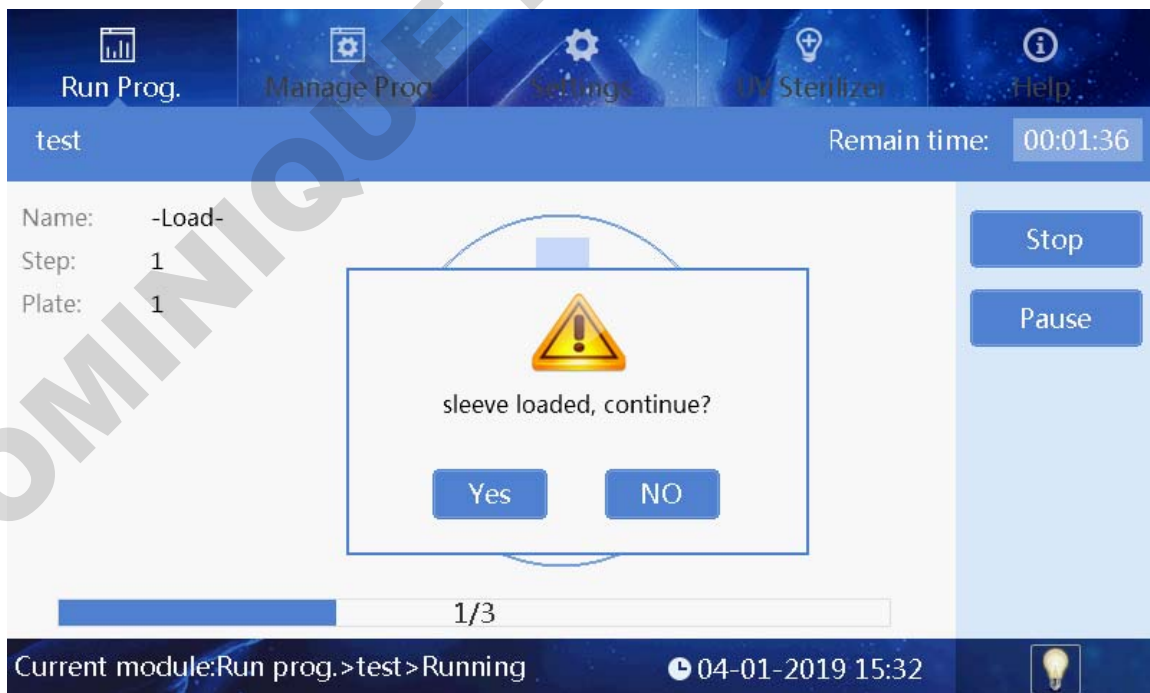

Fig 13

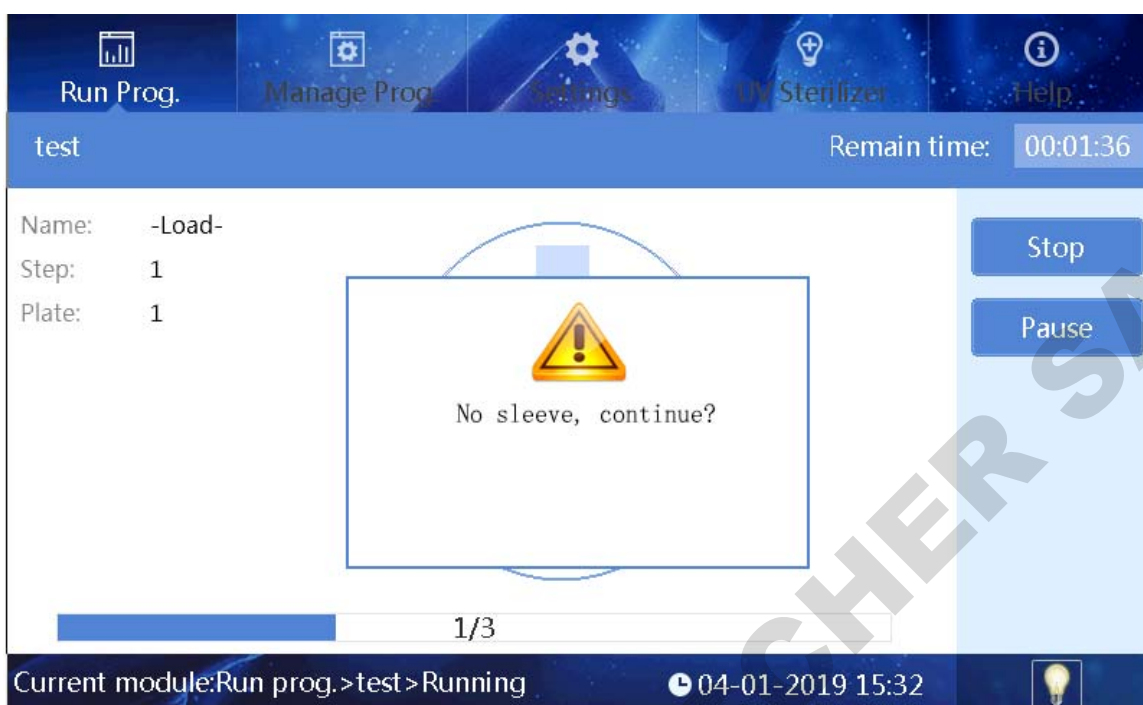

Fig 14

After the magnetic rod sleeve is successfully installed, the instrument automatically performs the following steps, please see Fig 15.



Fig 15

In the running interface, users can stop, pause, continue or run the program again. The plate with dark blue color, number 1, is the working

plate, the red corner marks on it means the plate is running or already finished running, while blue corner mark means the plate which is ready to run, one corner mark means one running and two means two runs. A corner mark represents the plate position used once in the whole program.

After the completion of the operation, the No. 8 plate position will be automatically pushed to the transparent cover on the right side.

3.2.2. View

In the list mode or shortcut mode, select the required program, and click “View” button to enter the view interface (See Fig 16). Users can view each parameter settings of the program.

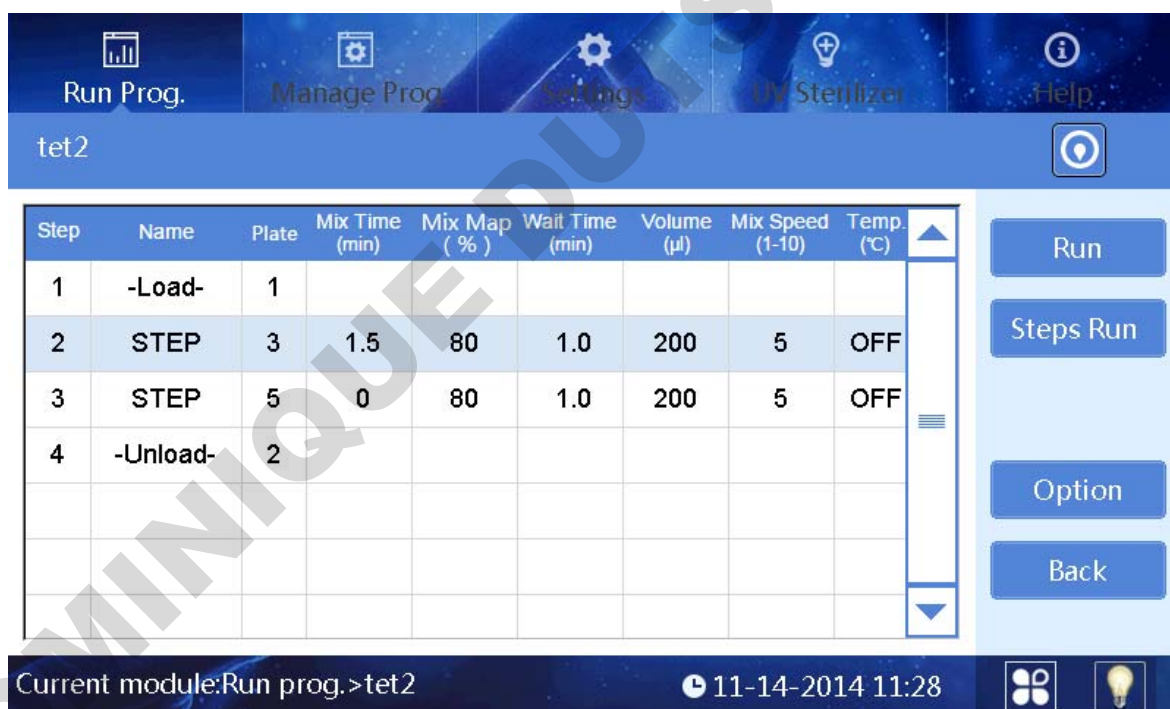



Fig 16

Users can click button  in the upper right corner to switch to the graphic display. Highlight displays the plate position which corresponding to the selected step, please see Fig 17 as below.

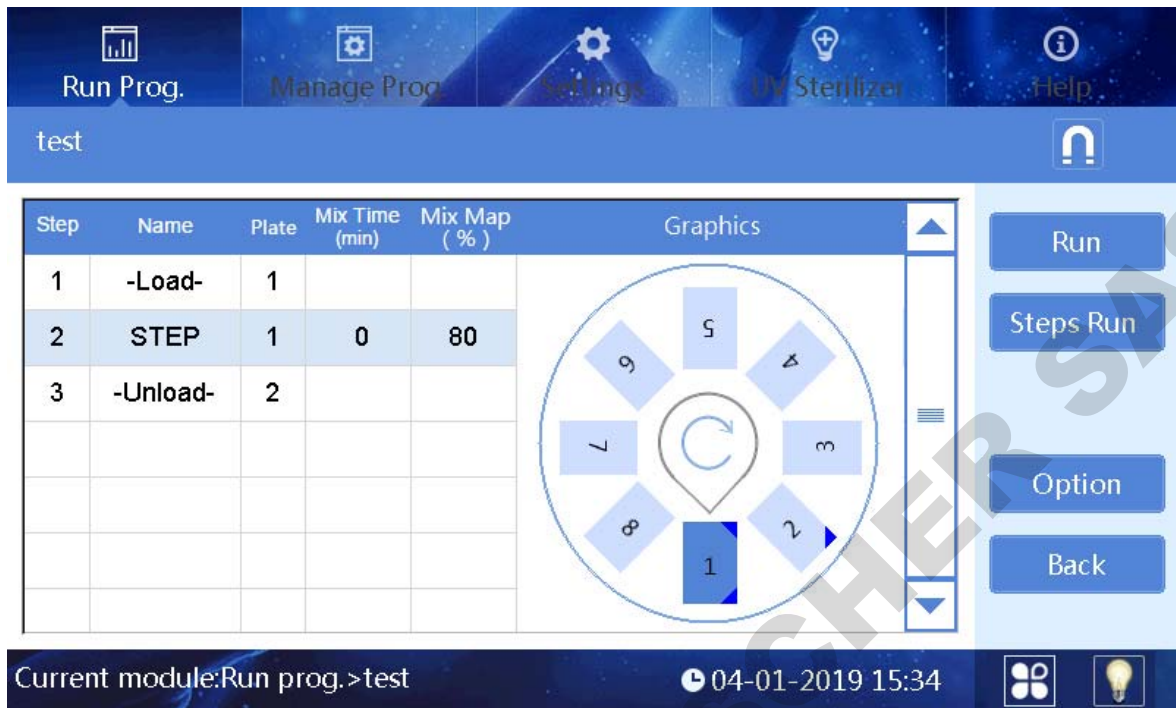



Fig 17

Then click button  to magnetic parameter absorption interface which displays magnetic parameters of selected step as shown in Fig 18.

“Steps Run”: run the program starts from currently selected step.

“Option”: view settings of the program, please see Fig 19.

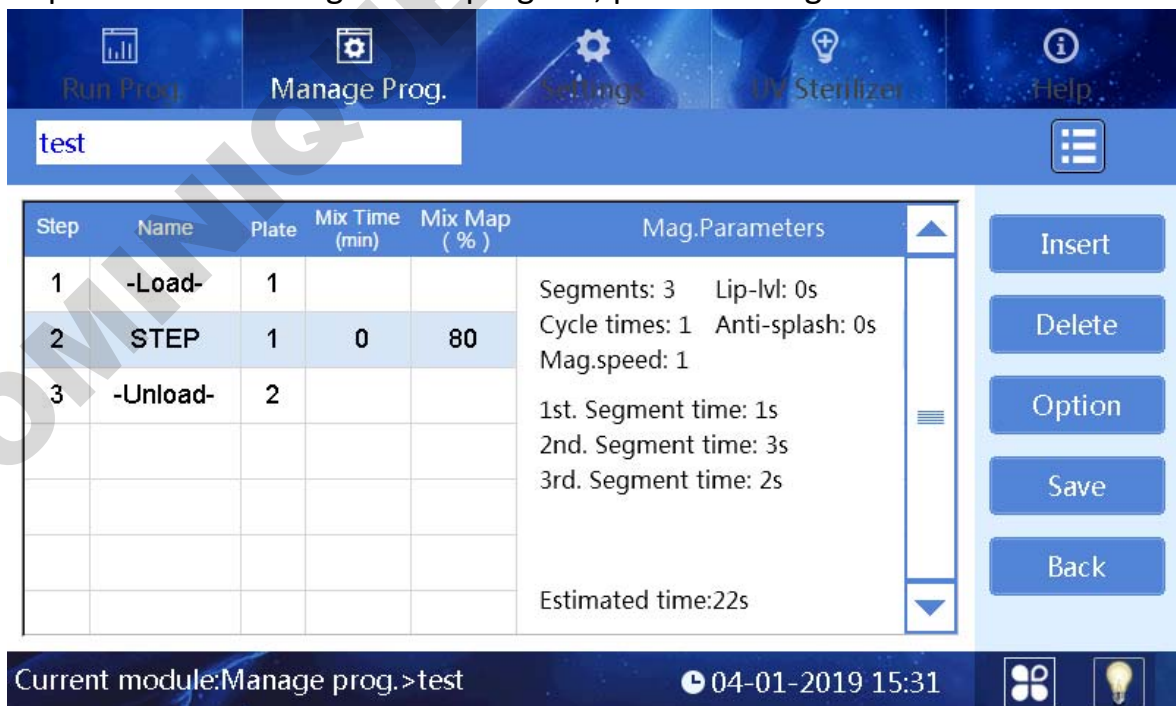

Fig 18

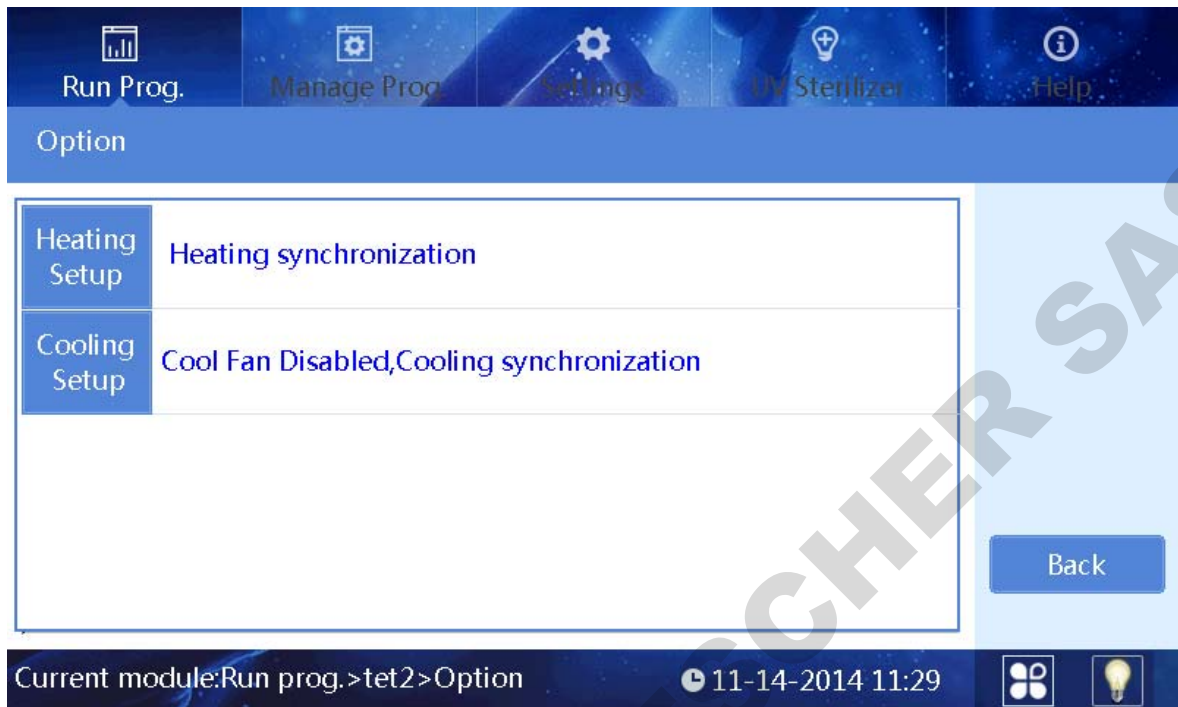

Fig 19

3.3. Manage Program

Users can manage all programs in “Manage Prog.” interface.

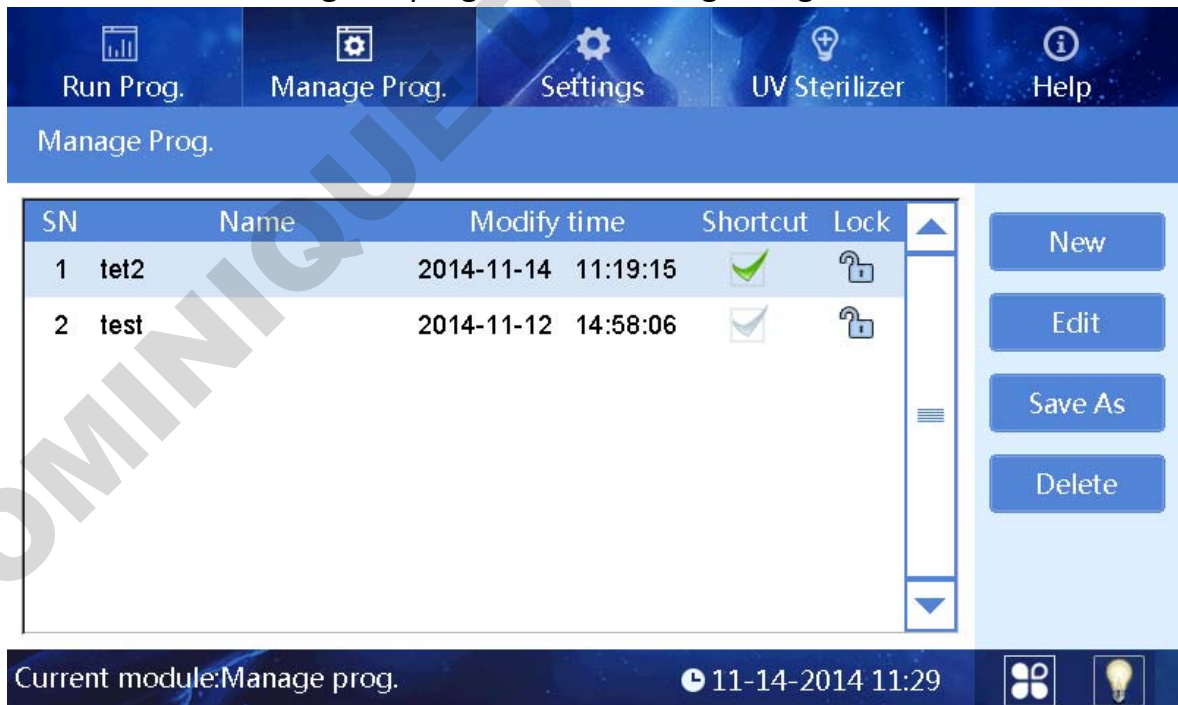

Fig 20

3.3.1. Management Interface

Management interface is similar to list interface in program operation, except that locking column is non-operable option in program run interface while it's an operable option in management interface. Click the lock icon to switch lock and unlock. Programs cannot be edited, saved or deleted if in lock state, please make the change in unlock state.

3.3.2. New/Edit interface

When the users click the "New" or "Edit" button, interface of Fig 23 will appear, the main difference between "New" interface and "Edit" interface is whether the program name exists or not, other operations are similar. This interface mainly includes five buttons: "Insert", "Delete", "Option", "Save" and "Back".

Insert: click "Insert" to add a new program with default parameters next to the current selected program, the new program should be with a valid name.

Delete: delete the selected program.

Option: Option is the high-level parameter setting which applies to the entire program scope.

Save: save the program file, please note a valid program name is necessary.

"Insert" interface as Fig 22.

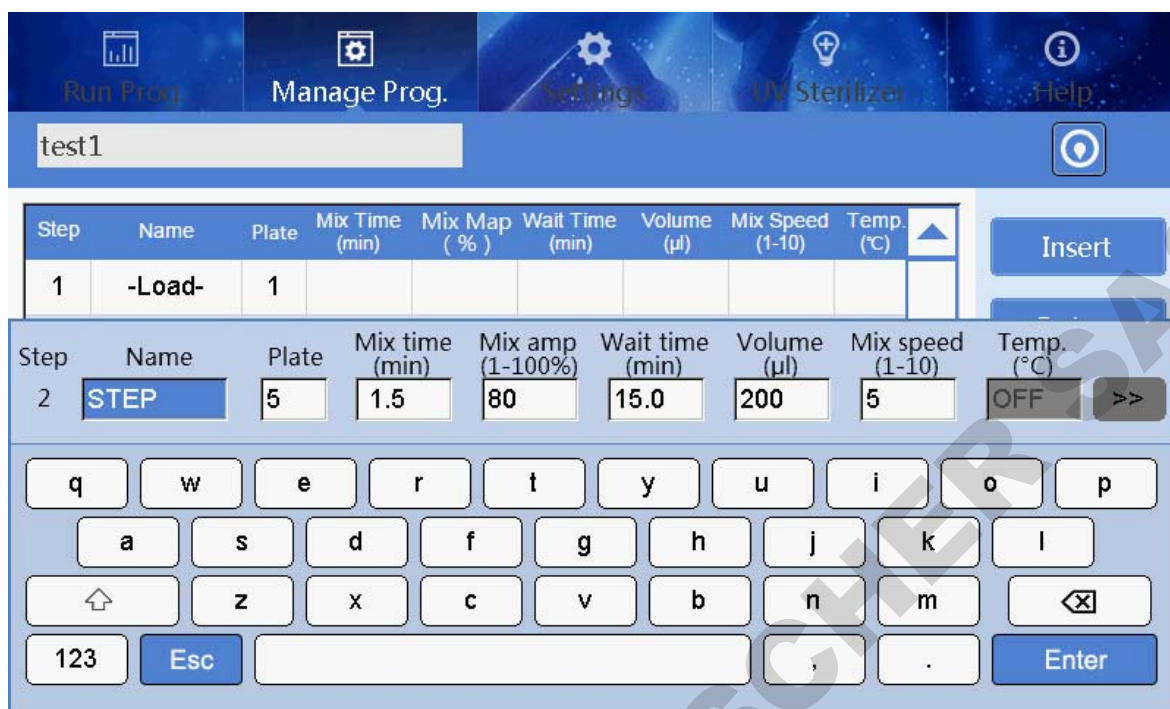

Fig 22

Plate: select a plate position for the coming operation

Name: set a name of the step

Mix time: the mixing time for selected plate.

Mix amp: mix amplitude, the range is from 1 to 100%.

Wait time: interval time between two steps.

Volume: The volume is automatically converted to the amplitude of mixing according to the formula.

Mix speed: 10 kinds of mix speeds from 1 to 10. The higher the value is, the faster the mixing speed will be.

Temp.: The temperature can be set according to actual requirements, only No.2 and 8 wells can be set.

Click “>>” to enter parameter settings of magnetic absorption, see below picture please.

Step	Name	Plate	Mix Time (min)	Mix Map (%)	Wait Time (min)	Volume (µl)	Mix Speed (1-10)	Temp. (°C)
1	-Load-	1						

Step	Segments (1-5)	Cycle times (0-10)	Mag.speed (1-10)	Lip-lvl (0-30)s	Anti-splash (0-30)s	Estimated (s)
2	3	3	1	0	0	48

1st. Segment time	5 (s)	2nd. Segment time	6 (s)
3rd. Segment time	5 (s)	4th. Segment time	0 (s)
5td. Segment time	0 (s)		

1	2	3	4	5	6	7	8	9	0
---	---	---	---	---	---	---	---	---	---

Fig 23

Segments: setting range is 0 ~ 5, it can stop to do magnetic absorption for each segment, magnetization function will be closed if set it to 0.

Cycle times: repeat magnetic absorption times.

Mag.speed: It's magnetic absorption speed when magnetic rod moves under the liquid level. 1 is the slowest while 10 the fastest.

Lip-lvl: the standing time when magnetic rods closing to liquid level after finishing magnetic absorption which is for magnetic beads gathering in case beads falling off due to liquid surface tension.

Anti-splash: the standing time when magnetic rods pulling away from liquid level after finishing magnetic absorption, in case cross contamination which caused by liquid splashing due to some special sample tissues falling off.

1-5 Segment time: independent magnetic absorption time of each segment, the maximum time can reach to 999 seconds.

Estimated: The estimated magnetic absorption time of the software. It can only be displayed on the next entry after exiting the interface.

3.3.3. Option

In program new or edit interface, click the "Option" to enter the option interface. The parameters in the option are applied to the whole program as shown in the figure below.

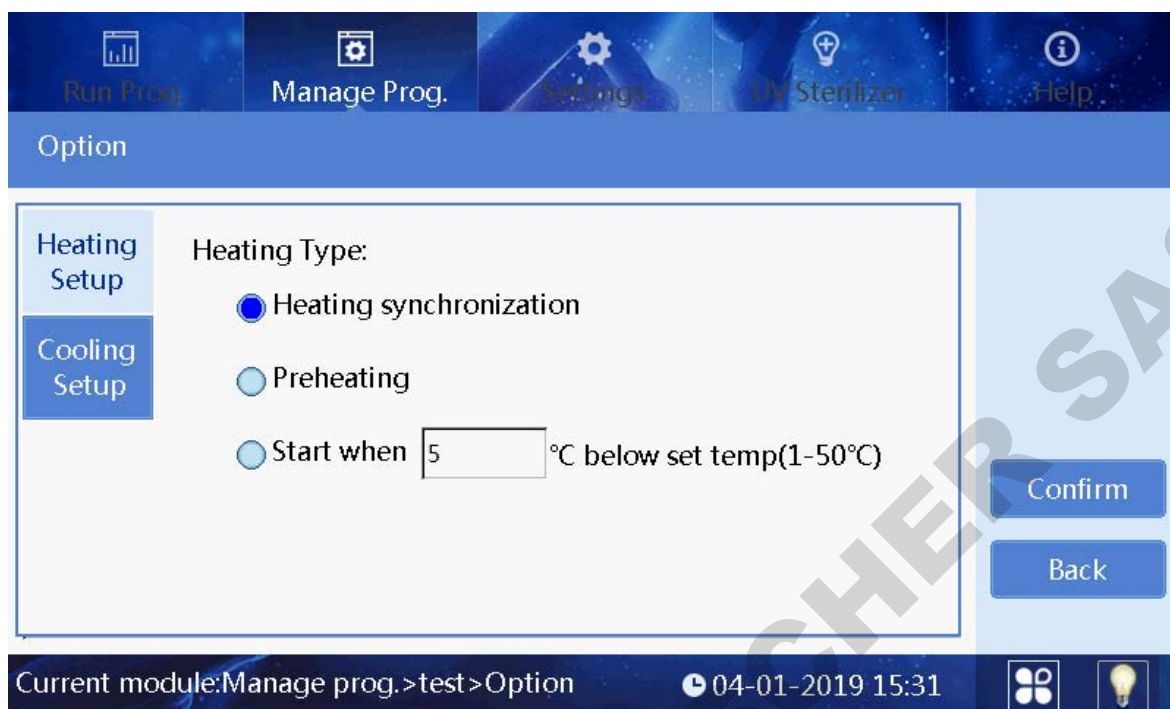

Fig 24

Confirm: Save all settings and exit.

Back: Not save all settings and exit.

Heating Setup: It is used to set the heating type.

➤ Heating synchronization: It indicates that the heating and magnetic rod sleeve action are synchronous.

➤ Preheating: It indicates that the heating board will rise to the set temperature first, and then the magnetic rod sleeve frame starts to work.

➤ Start when: It indicates that the magnetic rod sleeve frame starts to work when the temperature rised to the set temperature which is lower than the target temperature.

Cooling Setup: It is used to set the cooling type.

3.3.4. Save As/Delete

In the “Manage prog” interface, click the save as button to save the file, and click the delete button to delete the file.

3.4. System Settings

In system setting interface, “Instrument”, “Date&time”, “Language”, “Air ejector fan”, “Im.&export” and “Upgrade” can be modified.



Fig 25

3.4.1. System Time

Click “Date & time” button to enter modification interface, as shown in the figure below.



Fig 26

The date and time can be adjusted by “+” or “-” buttons.

3.4.2. Language Settings

Two options: Chinese and English.



Fig 27

Select the language , press “Ok ” to save the modification.

3.4.3. Fan

Click “Air Ejector Fan” to choose “On” or “Off”.

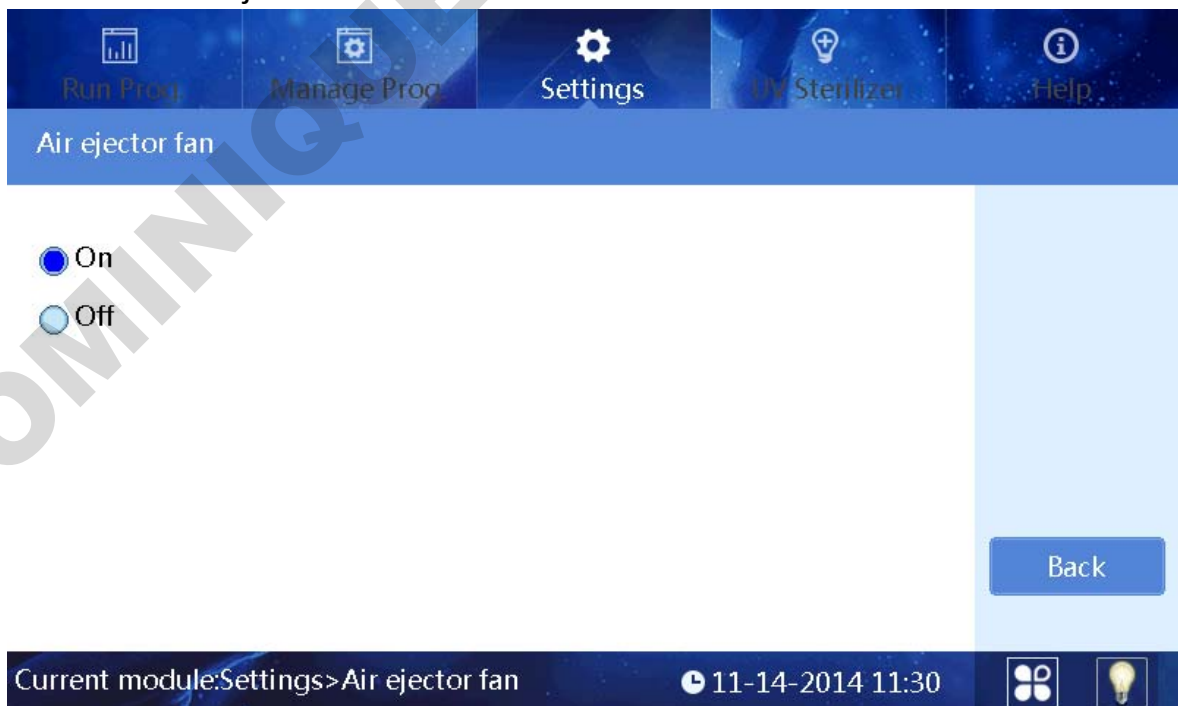

Fig 28

3.4.4. Import and Export

Click the "Im.&export" to below interface.



Fig 29

Press the "Import " to enter U disk directory and then select the program needed, press the "Ok" to import.

Press the "export" button to enter the system directory, select programs and then "Ok" to export files to the U disk.

3.4.5. Software Upgrade

Click "Upgrade" to upgrade interface, see Fig 30 please.

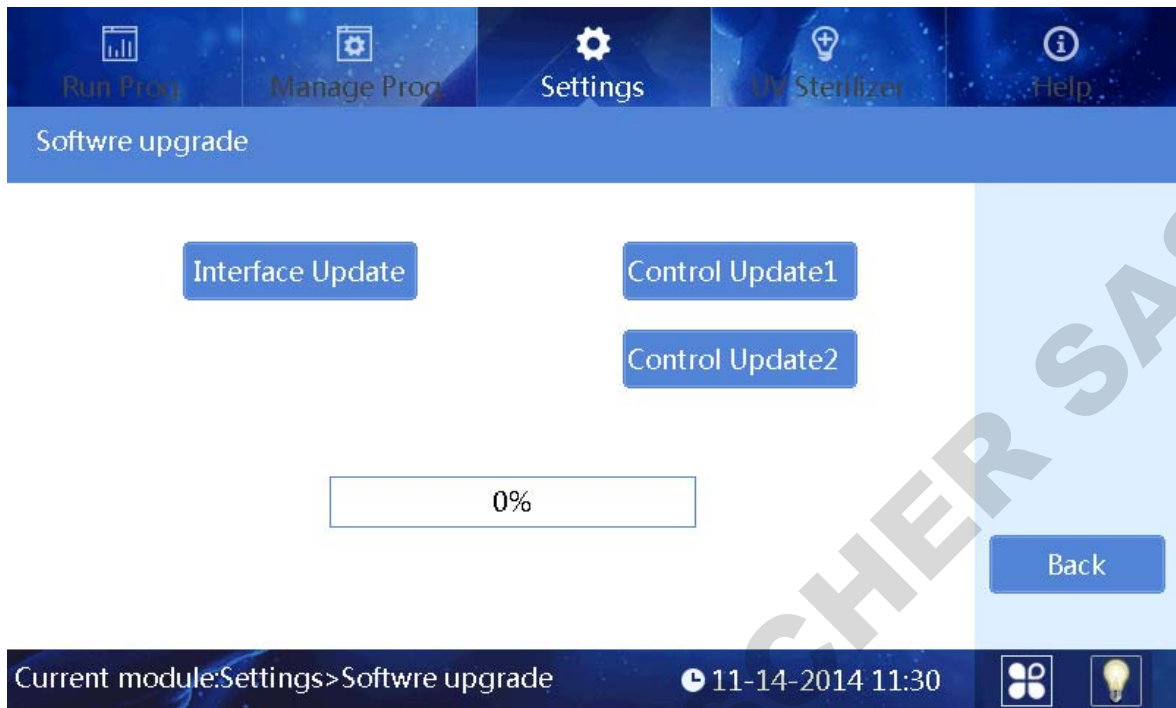

Fig 30

Insert the U disk with the latest software in, and then upgrade the interface software or control software of the instrument.

3.4.6. Operation Record

Each run of the program automatically generates a running record.

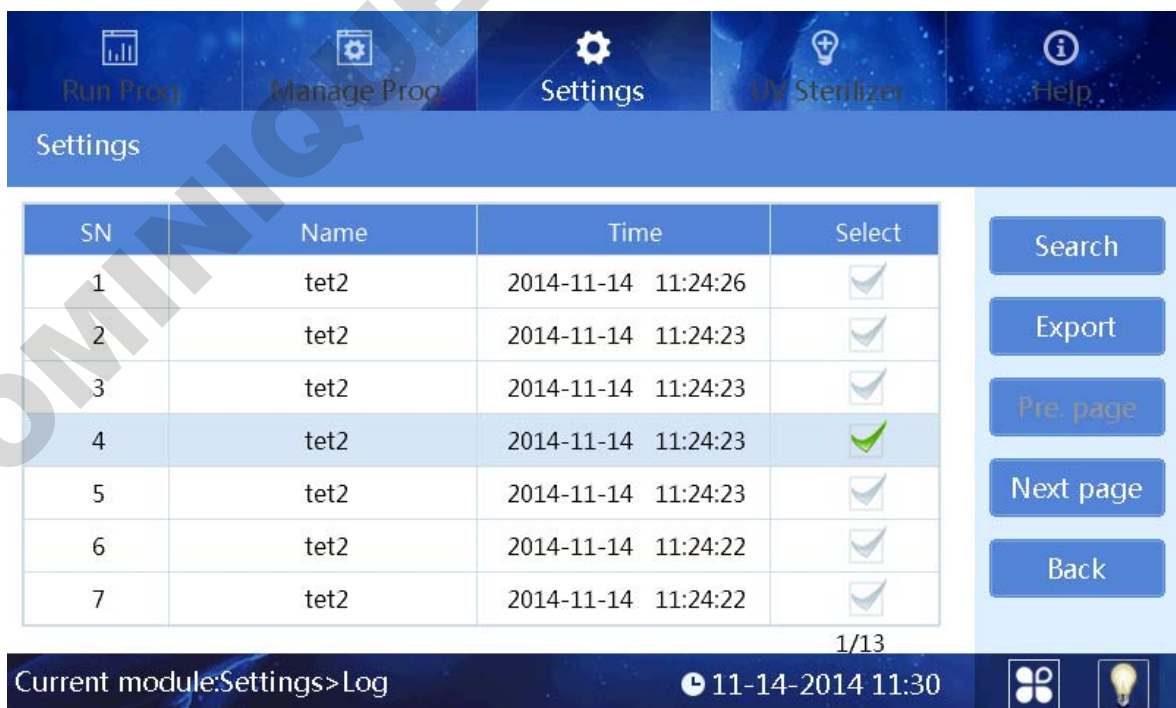

Fig 31

Users can trace records by “Search” button, see Fig 32 please.

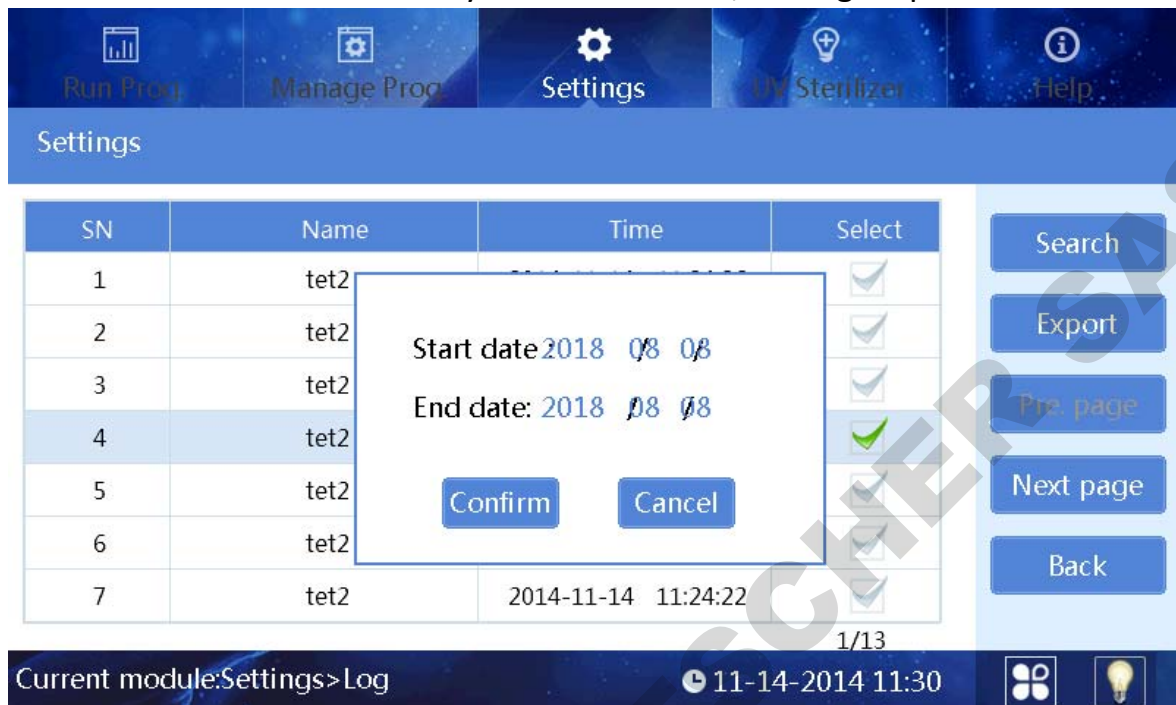





Fig 32

Log exports can be done through the export key.

3.4.7. Lighting

At the rith bottom of the screen, if icon “” appears, it means the lighting is on while lighting is off if the icon displays “”. Users can click the icon to switch between on and off.

3.4.8. Auxiliary function

Plate position switch function and Sleeve automatic installation function can be used with the software. In the plate position switch interface as Fig 33 below, click  to choose the plate that you want to switch it to the position of right transparency window(as the plate 2 position in the Fig 33).

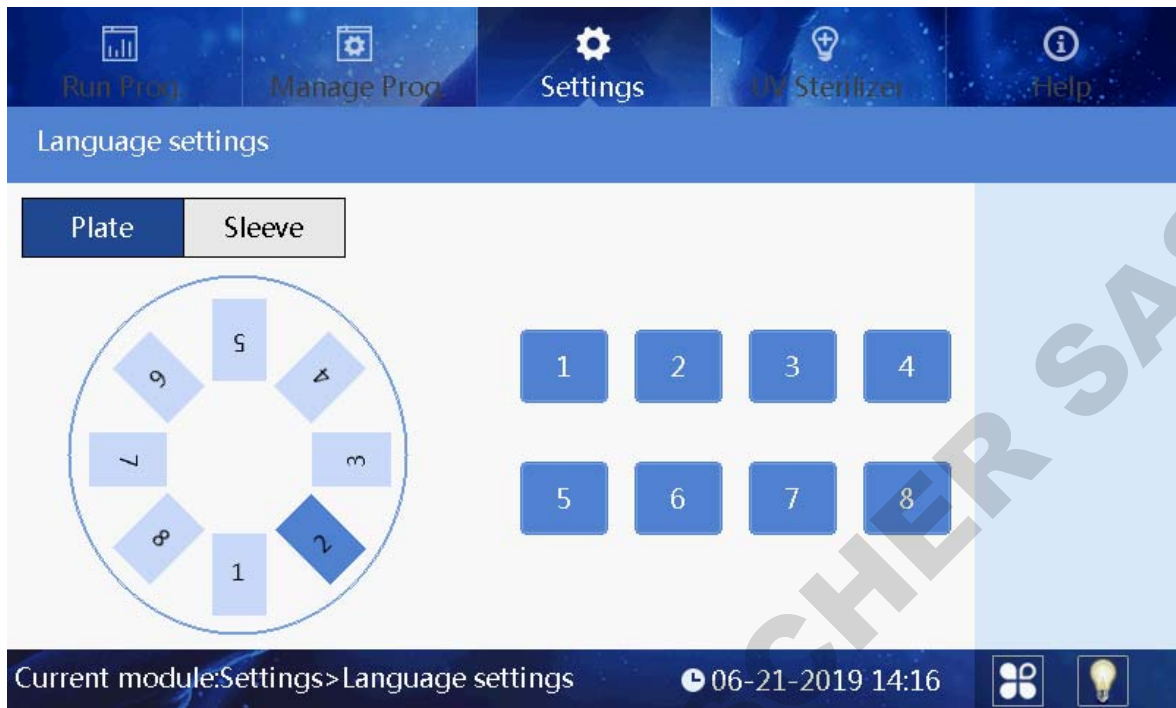

Fig 33

Click Sleeve button to choose the plate position which you want to automatically install/uninstall the sleeve as Fig 34 below.

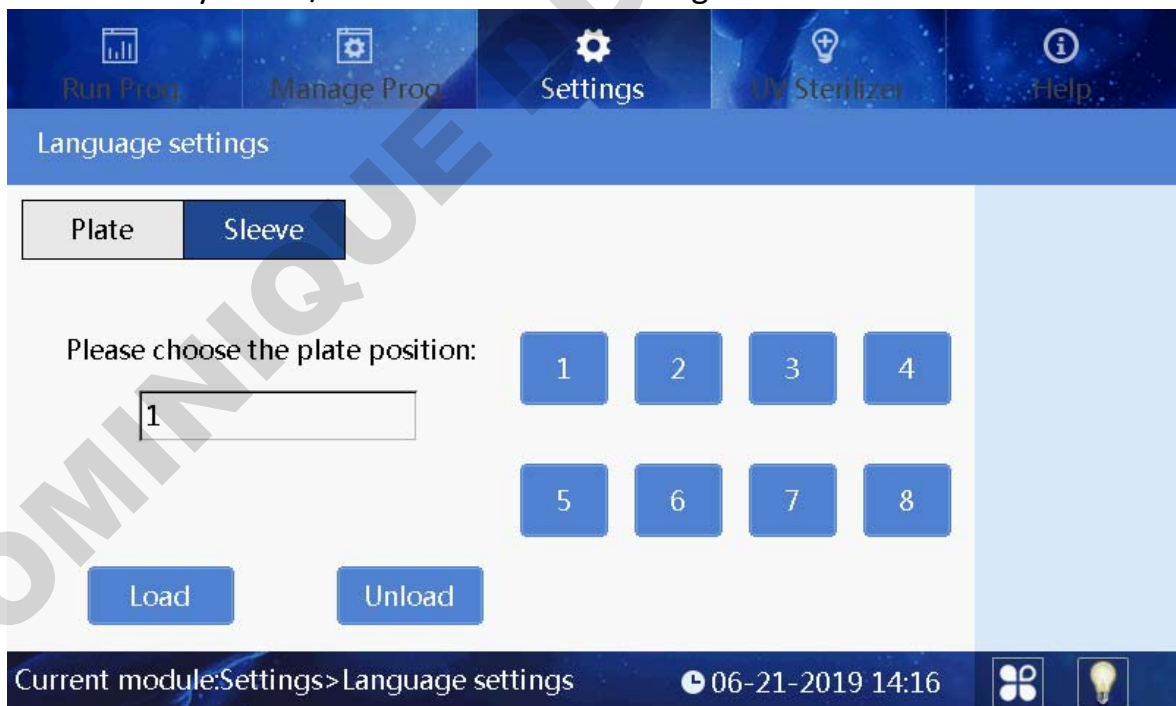

Fig 34

3.5. UV Sterilization

The UV disinfection interface is mainly used for the opening and closing of the UV lamp. The time can be set by pressing “+” or “-” button.

The program can automatically determine half of the set time to sterilize the half circle of the rotary table, with a minimum of 2min, as shown in the figure below.

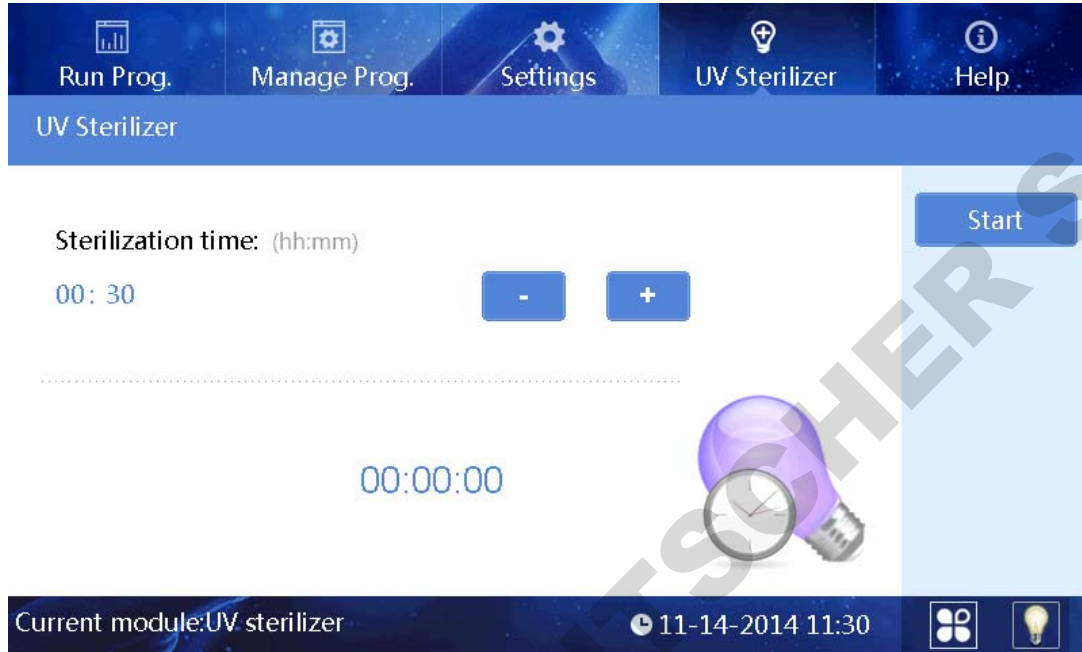

Fig 36

3.6. Help

Help interface displays help information and version as shown in the figure below.

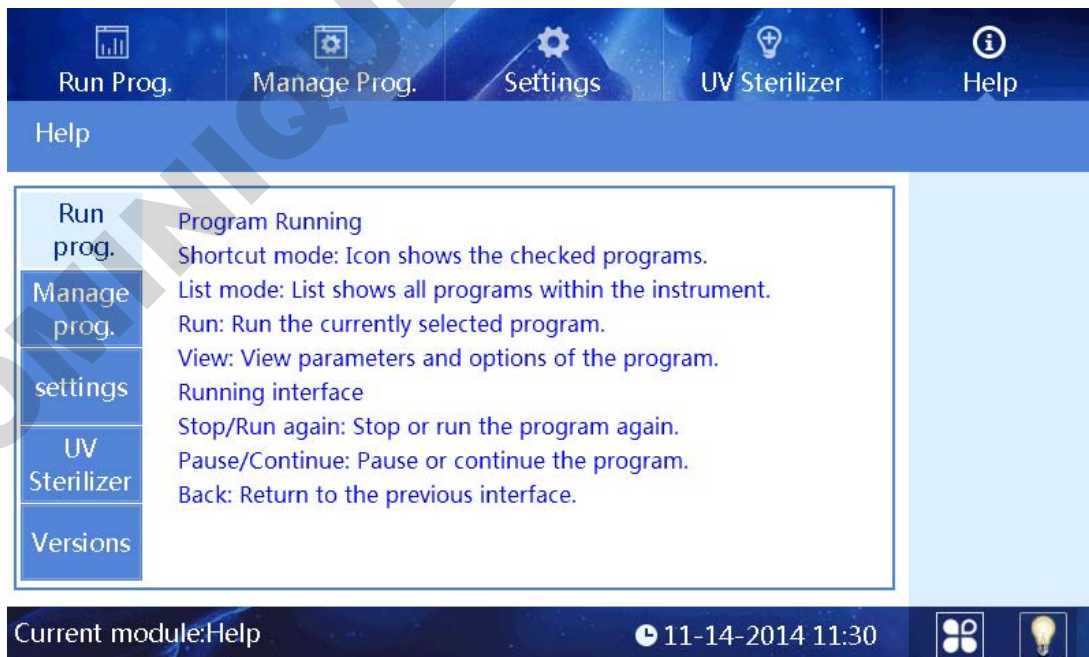

Fig 37

Chapter 5 Trouble Shooting

1. Troubleshooting

No.	Symptom	Causes Analysis	Method
1	No display after switch on	Power not connected	Check power
		Switch failure	Replace switch
		Fuse failure	Replace fuse (5X20 250V 8A)
		Others	Contact with Distributor
2	No UV light	UV light failure	Replace light tube Contact with distributor
3	No light	Light failure	Replace light tube Contact with distributor
4	Can not stop automatically after opening the door.	Sensor failure	Contact with distributor
5	Big variance between actual and display temperature	Sensor failure	Contact with distributor
6	No heating for heating strip	Sensor failure	Contact with distributor
		Heater failure	
7	Instrument can't run	Controller failure	Contact with distributor
		Motor failure	
8	Abnormal sound during working	Guide rail installed incorrect	Contact with distributor
		Motor failure	
		Synchronous belt abrasion	
9	Press button not working	Press button failure	Contact with distributor

2. Software Error Alarm List

Fault type	Fault name	Error
Temperature (code: 0)	T1 Overheat	E011
	T1 Open circuit	E015
	T1 Short circuit	E016
Electric machinery stroke position (code:4)	Baffle motor sensor	E404
	Rotary motor sensor damaged	E405
	Lifting platform motor sensor damaged	E406
	Push rod motor sensor damaged	E407
	Motor position sensor of magnetic rod sleeve damaged	E425
	Magnetic rod motor position sensor damaged	E415
LCD, Crystal oscillator, Storage (code: 7)	The clock crystal fault	E702
	Memory chip E2P damaged Setting parameters lost	E703
	New instrument, instrument type hasn't been set	
	Zero has not been calibrated, the instrument zero calibration is not in the 3 well will lead to the program does not working	
Communication (code: 8)	Moving parts online failure	E801
	Rotary parts online failure	E802

Chapter 6 Accessory

No.	Name	Specs.	Unit	Qty.	Remark
1	Power cord		PCS	1	
2	Mouse	Logitech	PCS	1	
3	U disk	8g	PCS	1	For upgrading software and transferring programs

Chapter 7 Abbreviations and Tags



1. Abbreviations

The following Abbreviations are for reference and will appear in this operation manual.

A	ampere
AC	alternating current
V	volt
Hz	Hertz
W	watt
USB	universal serial bus
SD	secure digital card
WiFi	wireless Fidelity
Kg	kilogram
mm	millimeter
μ L	microliter
hpa	hectopascal
$^{\circ}$ C	degree centigrade
CV	stability
TAB	tab
RUN	run
STOP	stop

2. Tags

Following marks appear on the instrument

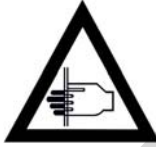
	Warning label
	Heating label
	CONFORMITE EUROPEENNE
	Be careful of hands

Notes

DOMINIQUE DUTSCHER SAS