

Operation Manual

Version 4.0

AMR-100 Microplate Reader



ALLSHENG

Hangzhou Allsheng Instruments Co.Ltd.

Foreword

Thank you for purchasing our Microplate Reader. This user manual describes how the instrument works and the operation guide, please read carefully before operation and keep for future reference.

Opening check

Please check the instruments as well as all accessories with packing list when you first open it. If you find any wrong or missing, please contact distributor or manufacturer.

HANGZHOU ALLSHENG INSTRUMENTS CO., LTD.

Address: Building 1 & 2, Zheheng Science Park, Zhuantang Town, Xihu District, Hangzhou, Zhejiang 310024, China

Tel: +86-571-88802738

Fax: +86-571-87205673

Post code: 310024

Website: www.allsheng.com

Email: info@allsheng.com

File No.: AS112SM

Version No.: 4th, May 2020

Safety warning and guidelines

1. Important information for safe use

Users should have a clear main idea on how to use this instrument before operate, do read this user manual carefully.



Any improper operation without reading manual is forbidden, otherwise there will be risks in cause accidental injury or electrical shock.
Do read manual carefully and operate safely according to this guidelines.



This instrument intended to use in Scientific Research only!

2. Safety Tips

The operation, maintenance and repair of the Instrument should comply with the basic guidelines and the remarked warning below. If you don't comply with them, it will have effect on the scheduled using life of the Instrument and the protection provided.



Indoor use only.



Warning: Biological contamination!! All samples for test, quality control, calibration are regarded as infectious, and any part contact with samples will also need to be treated as infectious. Please wear gloves when operate this device.



Before using the device, read the Manual carefully. These units are designed for use in laboratory environments. The device must be used by skilled personnel with the appropriate training.



Warning: Avoid injury. Keep your body or any part of body away 15cm (or more) from the instrument when running.



The operator should not open or repair the Instrument by himself, which will result in losing the qualification of repair guarantee or occur accident. If there is some wrong with the Instrument, please contact manufacturer for repair.



Before power on, guarantee the voltage used should be accordant to the voltage needed, and the rated load of electrical outlet should not lower than the demand.

If the electric line is damaged, you should replace it with the same type. You should assure there's nothing on the electric line and you should not put the electric line in the ambulatory place.

Hold the socket when you pull out the plug, and don't pull the electric line only.



The Instrument should be put in the place of low temperature, less dust, no water and no sun or strong lamp. What's more, the place should be good ventilation, no corrosively gas or strong disturbing magnetic field, far away from central heating, camp stove and other hot resource.



Power off when you finish your work. Pull off the connector plug when there's long time no use of the Instrument and cover it with a cloth or plastic paper to prevent from dust.



Pull the connector plug from the socket at once in the following cases, and contact the vendor:

- There is some liquid flowing into the Instrument;
- Drenched or fire burned.
- Abnormal operation: such as abnormal sound or smell.
- Instrument dropping or outer shell damaged.
- Malfunction

Contents

Foreword.....	I
Safety warning and guidelines.....	II
1. Important information for safe use.....	II
2. Safety Tips.....	II
Contents.....	IV
Chapter 1 Brief introduction.....	1
Chapter 2 Features.....	2
Chapter 3 Instrument structure.....	3
Chapter 4 Installation.....	5
1. Opening check.....	5
2. Installation.....	5
3. Installation steps.....	5
Chapter 5 Operation guide.....	6
Section 1 Instrument self checking.....	6
Section 2 protocol interface.....	7
1. File management, Function Key and Operation.....	7
1.1. File management.....	7
1.2. Function button.....	11
1.3. Procedure.....	12
2. Protocol setting.....	13
2.1. Mode setting (Measure).....	13
2.2. Layout.....	15
2.2.1. Layout.....	15
2.2.2. Standard sample concentration setting.....	18
2.3. Shake setting.....	19
2.4. Calculate.....	21
2.4.1. Kinetic setting.....	21
2.4.2. Pre-process setting (double wavelength).....	23
2.4.3. Curves fitting setting.....	24
2.5. Interpret.....	24
2.6. Quality controls setting.....	25
Section 3 Report.....	27
1. Ordinary Report interface.....	27
1.1 Raw data.....	27
1.2 Interpret analysis data.....	28
1.3 Analysis.....	29
1.4 Curves.....	30
1.5 QC measurement result.....	30
2. Kinetics Report interface.....	31
2.1 Kinetics measurement Raw data.....	31
2.2 Kinetics measurement Analysis.....	32

2.3 Kinetics measurement Curve.....	32
Section 4 Settings.....	34
1. Language setting.....	34
2. Filter setting.....	35
3. Maintenance.....	36
4. Print setting.....	37
5. Time and Date setting.....	37
6. Help.....	39
Chapter 6 Maintenance, storage, transportation.....	40
1. Maintenance.....	40
2. Storage and transportation.....	42
Chapter 7 Trouble shooting.....	43
Chapter 8 Accessories.....	44

Chapter 1 Brief introduction

This microplate reader AMR-100 is professional instrument for ELISA test , measuring concentration, absorbance, positive or negative of the antibody and antigen in the sample by testing the color of the Enzyme - Linked Immunosorbent Assay (ELISA). This reader is widely used in clinical test, biology agriculture, food and environment research, especially benefit from ELISA kits increasingly wide utilization.

Highlights:

- Easy of use with 7 inch touch screen together with 3 external keys.
- English or Chinese operation system available for complete edit, measurement, save data.
- Able to use individually or connect with PC or PAD to control and export data.
- 8 positions optical filter wheel, equipped with 4 standard optical filters and optional filters available.
- 9 channel vertical optical path, zero dispersion single mode fiber measurement system, automatic plate well center position function.
- 96-well visual layout helps to mark blank, sample, positive/negative control, quality control and multi-value control.
- Multi-choice tests on single plate.
- Single or double wavelength measurement.
- Self-checking optical path, mechanical motion.
- Plate shaking function, time and speed are adjustable.
- Designed with light source energy saving.
- Different kind of data export ports available.
- Measurement results can be exported to “MS Excel” file.

Chapter 2 Features

Working conditions:

Ambient temperature: 4°C~45°C

The relative humidity: 10%~80%

Power: AC100-240V 50-60Hz 2A

The basic parameters and characteristics:

Model	AMR-100
Parameter	
Light source	6V 10W Quartz-Halogen lamp
Wavelength	340~750nm
Optical filter	Four standard filter 405/450/492/630nm, max load eight filters.
Read-out range	0.000-4.000Abs
Resolution	0.001Abs
Linearity	$R^2 \geq 0.995$ [0.0,3.0Abs]
Wavelength Accuracy	$\leq \pm 2\text{nm}$
Abs. Precision	[0,3) CV \leq 0.3% [3,4) CV \leq 1%
Abs. Stability	$\leq 0.005\text{Abs}$ [0.0,2.0Abs) $\leq 0.3\%$ [2.0,3.0Abs) $\leq 2.0\%$ [3.0,4.0Abs)
Abs. Accuracy	$\leq \pm 0.005\text{Abs}$ [0.0,2.0Abs) $\leq \pm 1.0\%$ [2.0,3.0Abs) $\leq \pm 1.5\%$ [3.0,4.0Abs)
Sensitivity	$\geq 0.01\text{Abs}$
Channel deviation	$< 0.01\text{Abs}$
Speed	Single wavelength $< 15\text{s}/96\text{well}$, double wavelength $< 28\text{s}/96\text{well}$ (Normal mode)
Dimension (W×D×H)	295 × 440 × 225 mm
Weight (kg)	10

Chapter 3 Instrument structure

Before first use of this instrument, please read this chapter carefully to make a better preparation.

Structure:

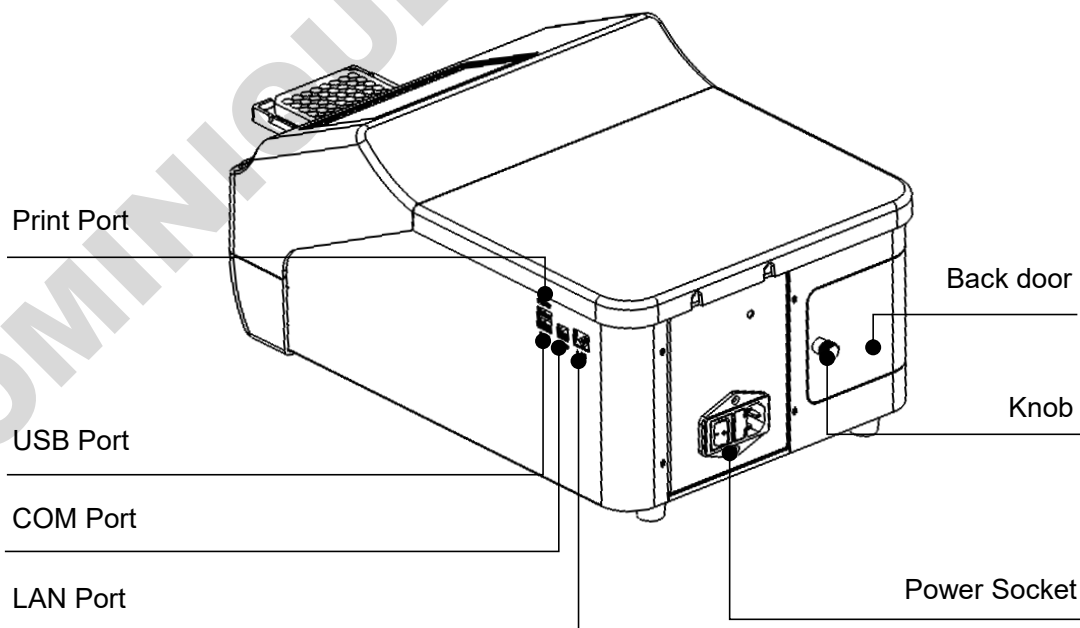
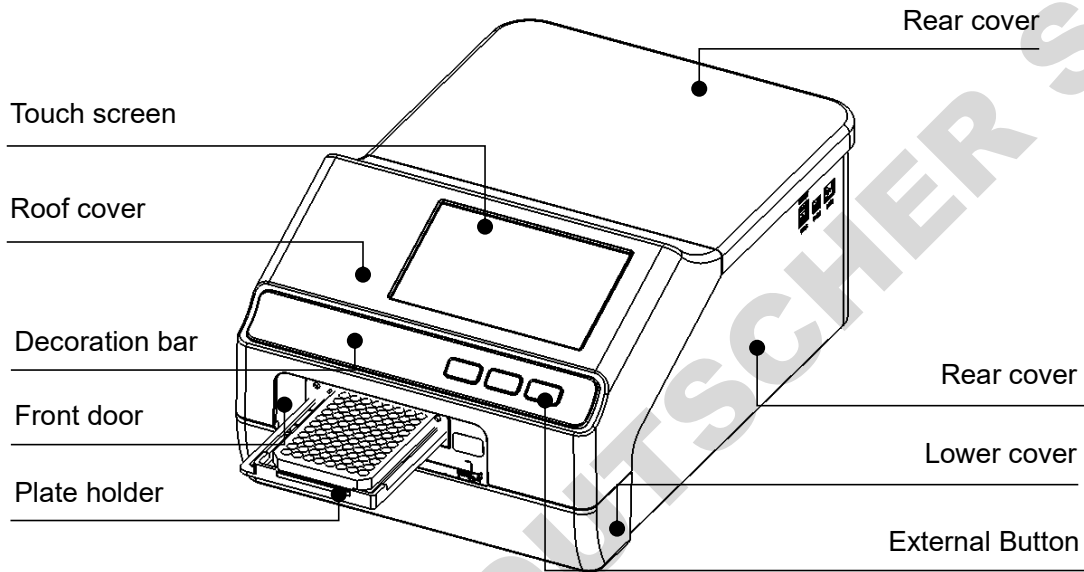

External button:	“Start”, “Stop” and “Plate in/out”.
Plate holder:	Hold microplate.
Print Port:	The port is only used to connect the printer.
USB Port:	the port can be used to connect U disk and mouse.
COM Port:	connect PC.
Back door:	can open to change light source and optical filter.
Knob:	To open back door.

DOMINIQUE DUTSCHER SAS

Chapter 4 Installation

1. Opening check

Each AMR-100 is completely checked before package, please check again when you receive instrument after transportation, contact your local distributor or manufacturer in case of:

- The outer package inverted or deformation.
- The outer package has an obvious stains of water.
- The outer package has marks of impact.
- The outer package has sign of open.

In case of outer good package, please check instrument and appendix.

- According to your packing list to check all accessories.
- Check instrument appearance if there is cracks or damage or deformation.

2. Installation

- Working condition: locate instrument on a flat dry and clean work table, keeping the front side with enough space for plate holder in and out, also keeping 15cm space for back, left and right side to enable put or connect wires.
- Working environment:
 - a.Clean air free from corrosion steam or smoke.
 - b.Temperature within +4°C to +45°C.
 - c.Relative humidity within 10% to 80% to avoid condensation.

Note: KEEP INSTRUMENT AWAY FROM DESTRUCTIVE GAS OR LIQUID!

3. Installation steps

- locate instrument on work table.

Note: Don't drive off any screws or parts unless for any specified steps, or it will affect the warranty and leads to damage of the device.

- Connect instrument to power supply.
- Instrument will start to self-checking after turning on.

Warning: The Instrument must be properly grounded before operating!!

Chapter 5 Operation guide

Section 1 Instrument self checking

This chapter introduces default protocol operation, it begins to self checking after turned on.
Refer to the picture below



fig 1

There are 4 parts in the software: protocol, Report, Settings, Help.
You can swift these 4parts by clicking icon area upside.

Section 2 protocol interface

After self-check complete, enter the software main “protocol” interface.

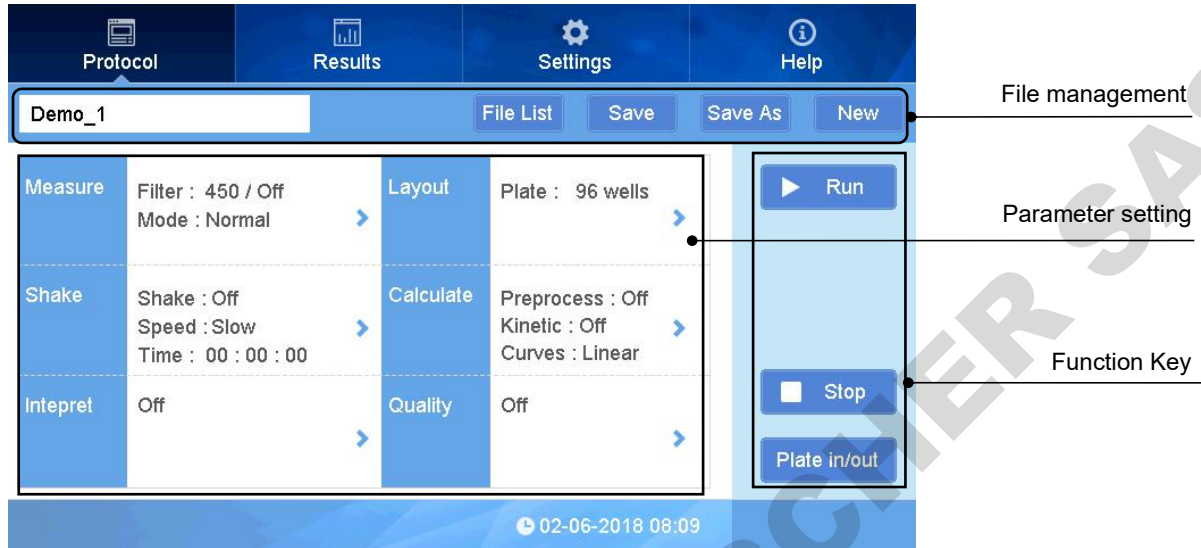



fig 2

1. File management, Function Key and Operation

1.1. File management

- The name of current protocol file: (Fig 2),

Note: There are two kinds of protocol files: one includes the detection data and analysis results with the icon “”, the parameter can’t be changed and can be used in measuring after rename the protocol file; the other only has the parameter of the protocol without any icon, the parameter setting can be changed and used in measurement.

- : New protocol

Click “New” to set the name of new protocol and then click “Enter” to save. After that, the parameter setting can be changed(Fig 3).

Note: The new protocol will be named automatically after the first protocol.

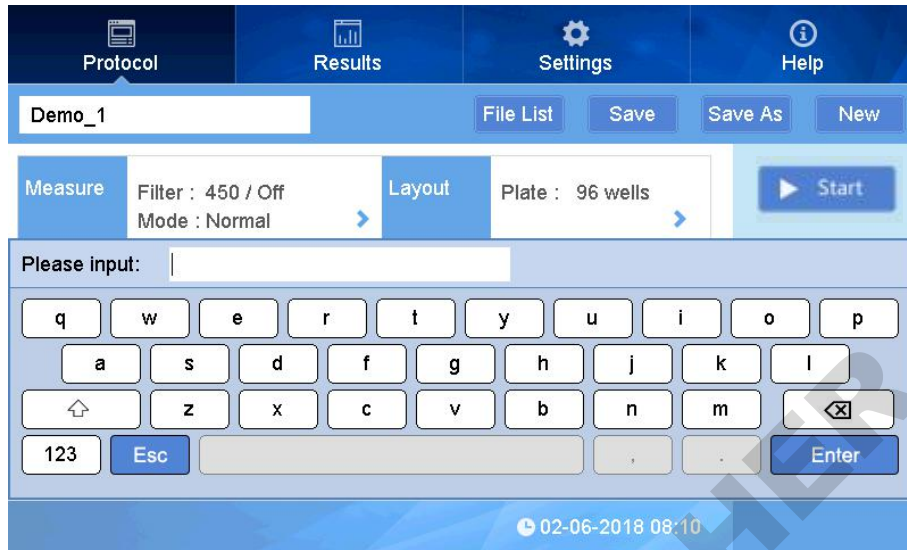

fig 3

- **Save** : Save the current protocol

Click "Save" button to save the setting protocol and view it in "File List".

Note: The new protocol will not be set after detecting sample and display in gray font; on the contrary, it still can be set.

- **Save As** : Save as new protocol

Click "Save As" to rename the protocol and save as new one.

Note: The save as protocol can be set based on the previous parameters. The detection data and parameter will be save at the same time.

- **File List** : Open the protocol file list

Click "File List" button to enter the interface(Fig 4) of all the protocol file. Choose the protocol file and click "Open" button, you can view the specific information of the protocol.

Click the "**Data** ↑↓" or "**Time** ↑↓" button to rank the protocol files.

Click the "**◀**", "**▶**", "**◀◀**", "**▶▶**" to page quickly.



fig 4

Click "Batch OP" to enter the interface(Fig 5):

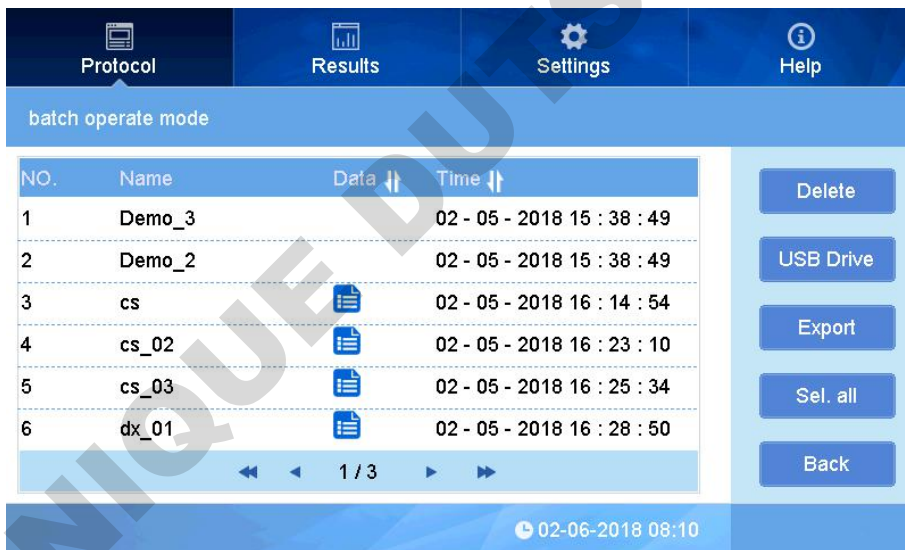





fig 5

You can batch deletion, import and export the protocol files.

 :Delete the protocol file(Fig 7).

 ,  : Click "USB Drive" button to exchange the protocol files between hard disk drive and external USB drive(Fig 6,8).

Export : Export the hard disk drive data to external USB drive.

Import : Import the external USB drive data to hard disk drive.

Sel. all : Select the whole protocol files in the hard disk drive (external USB drive) and then the button will be change to "**Desel. all**".



fig 6

Back : Back to the protocol interface.

Note: The protocol files in external USB drive couldn't be deleted.

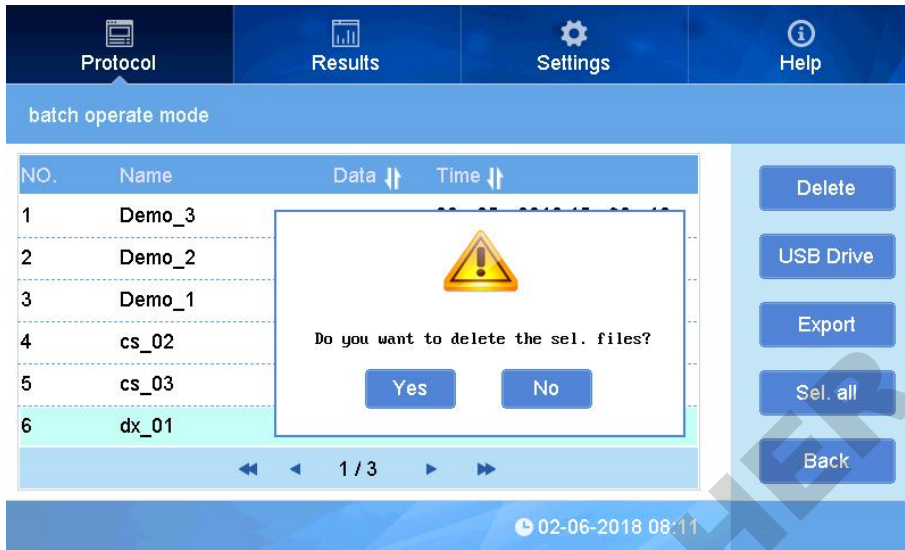

fig 7

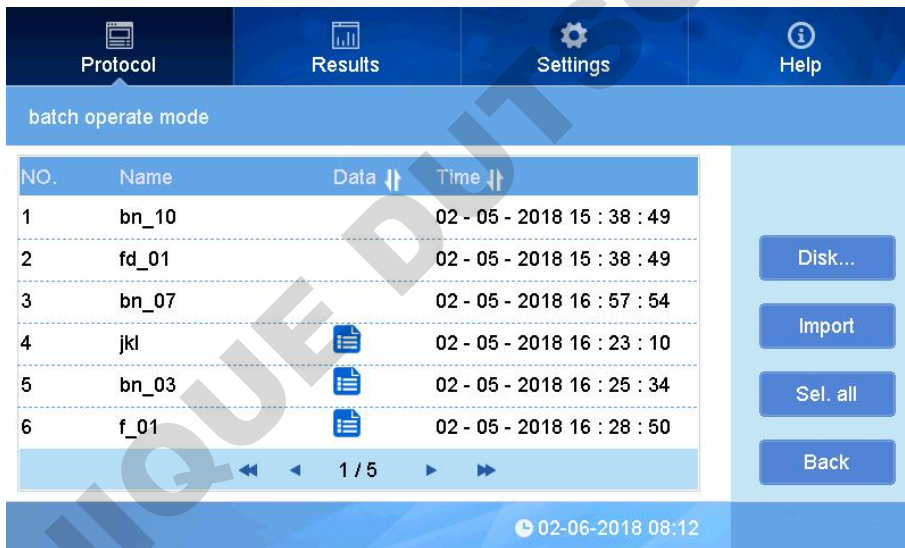





fig 8

1.2. Function button

 **Run** : Click to detect the sample.

 **Stop** : Click to stop the detection.

 **Plate in/out** : Click to control the Elisa plate in and out.

Note: It will create a new file when click “Run” button and then input the name of protocol file. Click “Enter” to start the running.

1.3. Procedure

Sample detecting procedure:

- Open the procedure file (or New) and set the parameter.
- Click the “Plate in/out” button on the screen or the front panel to put the Elisa plate into the instrument as Fig 9.



fig 9

- Click “▶ Start” on the screen or “Start” button on the front panel to start the running(Fig 10).

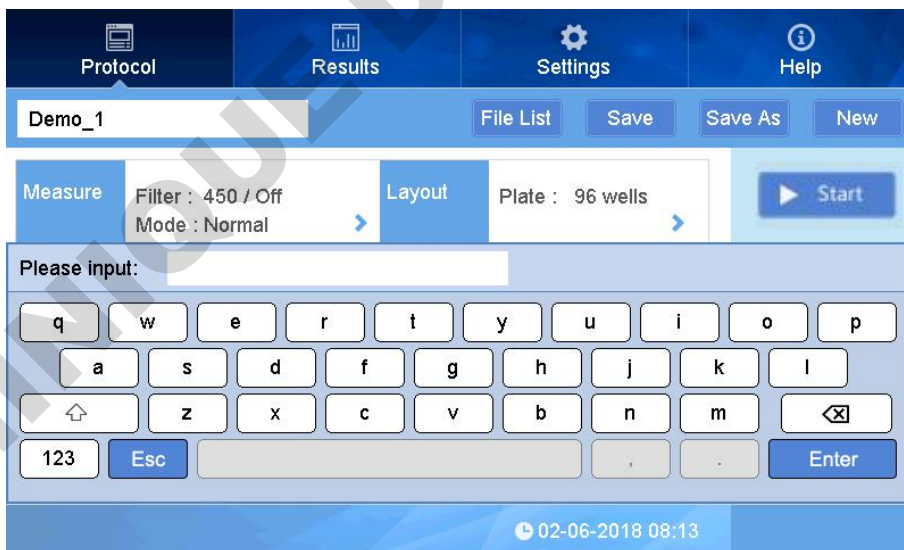

fig 10

Note: You can only click “Stop” button to stop the running.

After 15 sec running, it will enter the “Report” interface automatically and display the detection report(Fig 11).

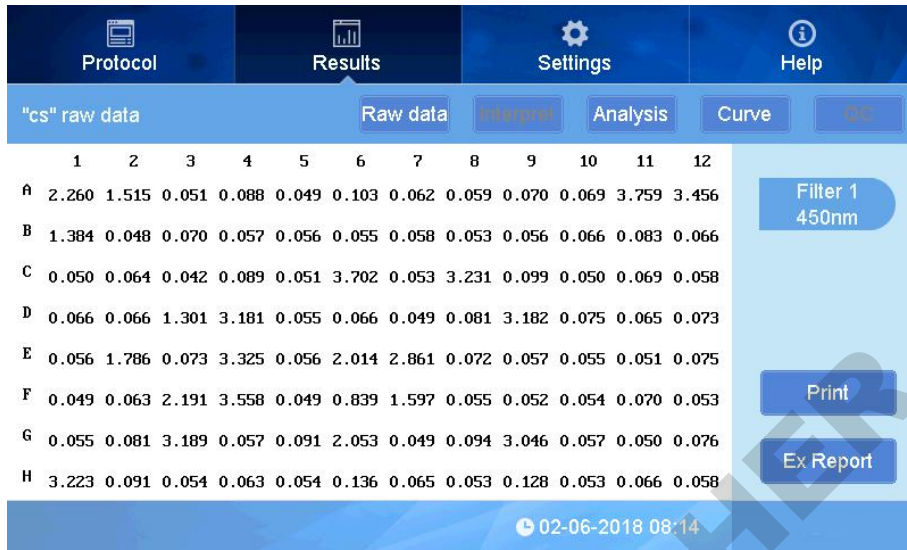

fig 11

2. Protocol setting

This part introduces how to create protocol, set parameters(wavelength, shaking mode), layout, shaking setting, data calculate, qualitative setting, quality control setting and protocol save.

2.1. Mode setting (Measure)

Wavelength and mode can be set in measurement mode.

- On interface “protocol”, click blank area near “Measure” to set parameters(Fig 12).

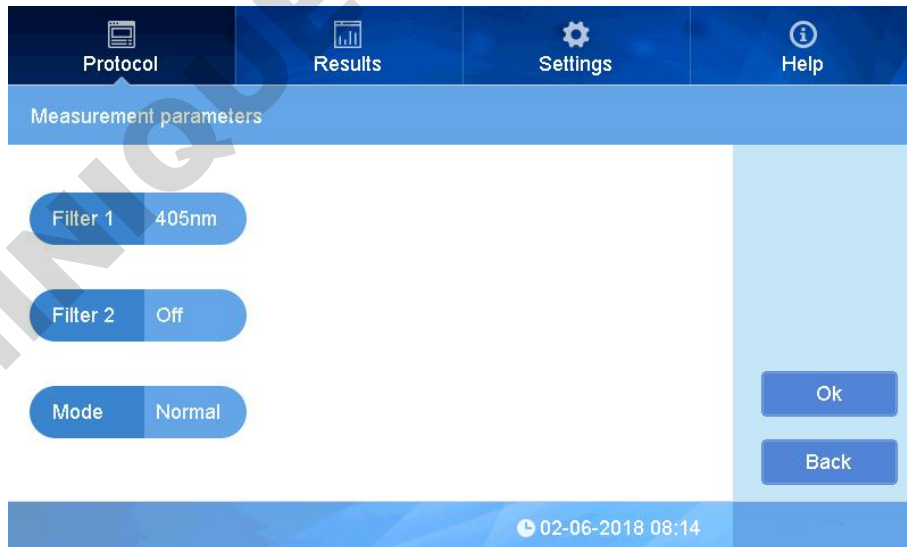

fig 12

● Filter1 Setting

Click right part near “Filter1” to choose wavelength(Fig 9).

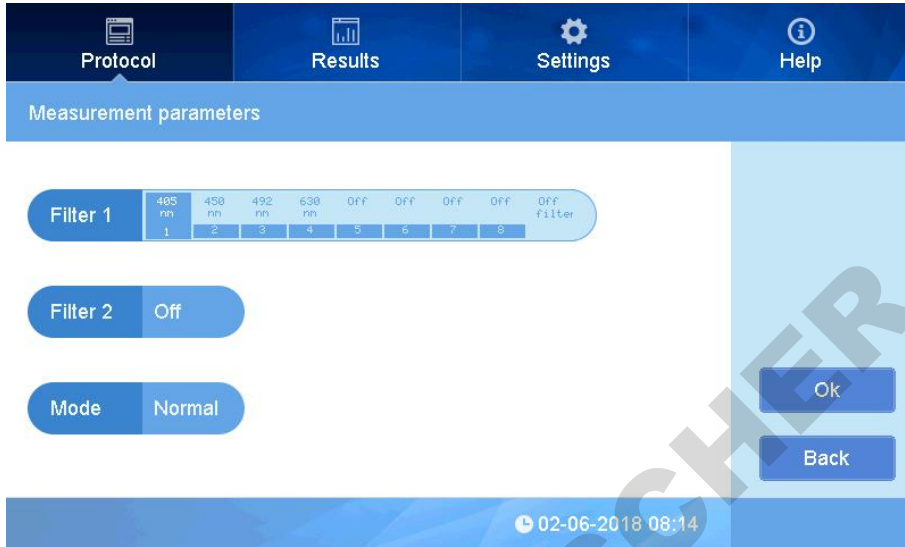

fig 13

There are 4 standard filter equipped: 405nm, 450nm, 492nm, 630nm, choose one as Filter1’s wavelength.

● Filter2 Setting

This instruments can measure with single wavelength as well as double wavelength. Click right part near “Filter2” to choose wavelength (choose a different wavelength to Filter1), see picture below:

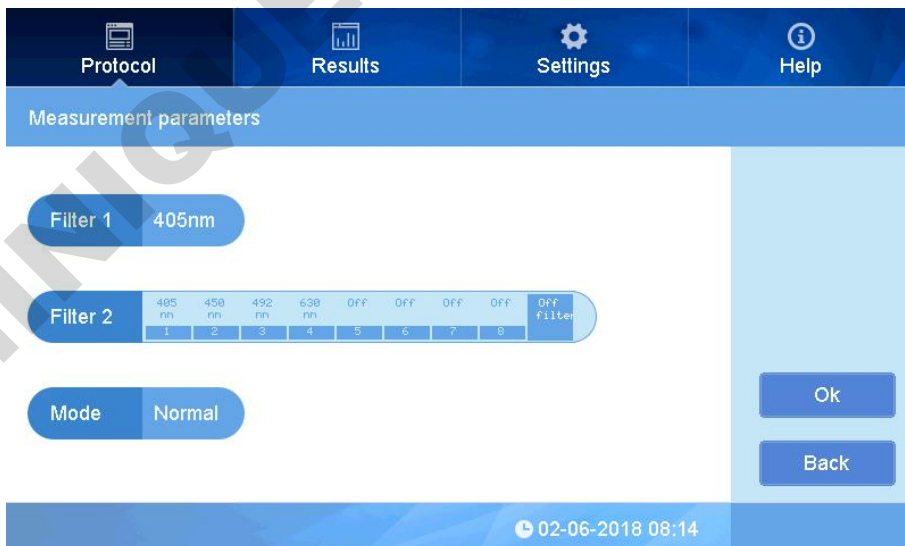

fig 14

Note: For single wavelength measurement, please choose “Off Filter” on Filter 2.

● Measurement speed choice:

Two mode available : Fast, Normal. Click right part near "Mode" to choose , see picture below:

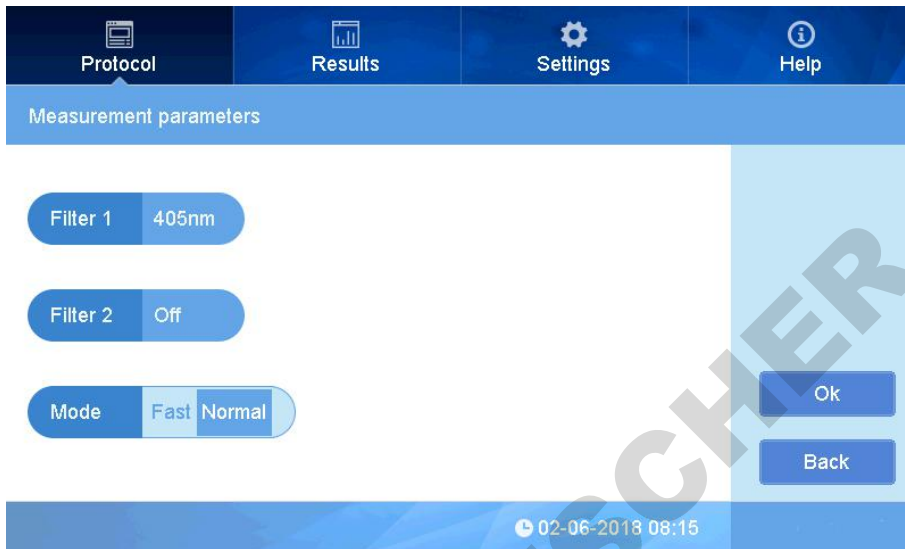

fig 15

Note: "Normal" mode is recommended .

- Press "OK" to finish setting and return back to main interface.

2.2. Layout

2.2.1. Layout

- In interface "protocol", "Plate layout" interface appears by pressing button right beside it, at the right side there are some buttons " Concentration", "Delete all", "OK", "Back", as Fig 16.

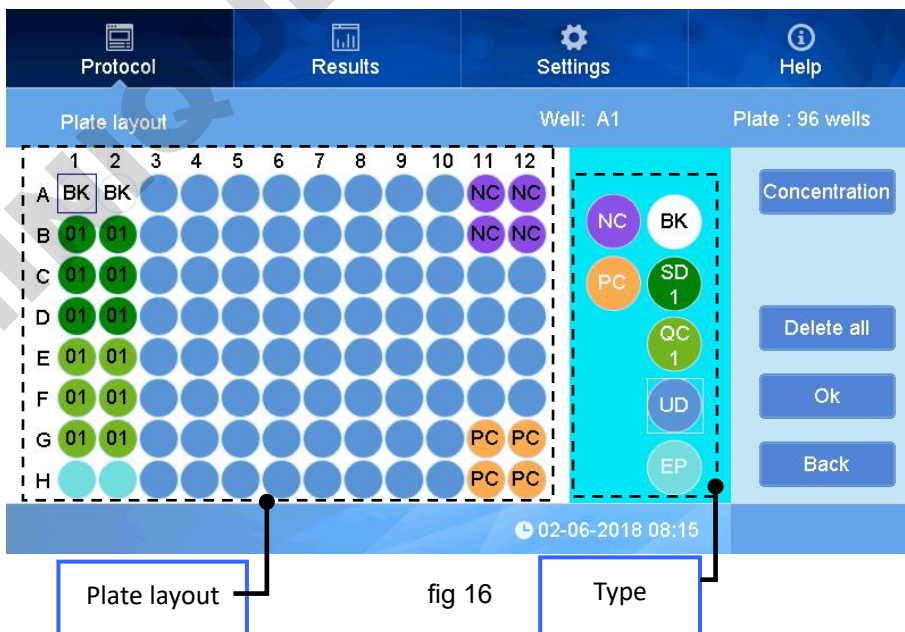



fig 16

- How to set layout: Firstly choose a type needed (the one be selected will be marked with white frame, like picture above UD(unknown sample) Type, then select well positions on plate layout (all positions are correspondent between plate layout and microplate) , the selected positions on layout will show the color of the type.
- Choose a Type from these seven types: BK,SD,QC,UD,EP,NC,PC, they are defined as below:



: Blank well for blank control, you can set several wells as blank.



: Standard sample well to set standard curve. Press  key(Fig 17), you can choose numbers for standard sample, choose the number you need, then number bar will disappear, and select the right well position on layout.

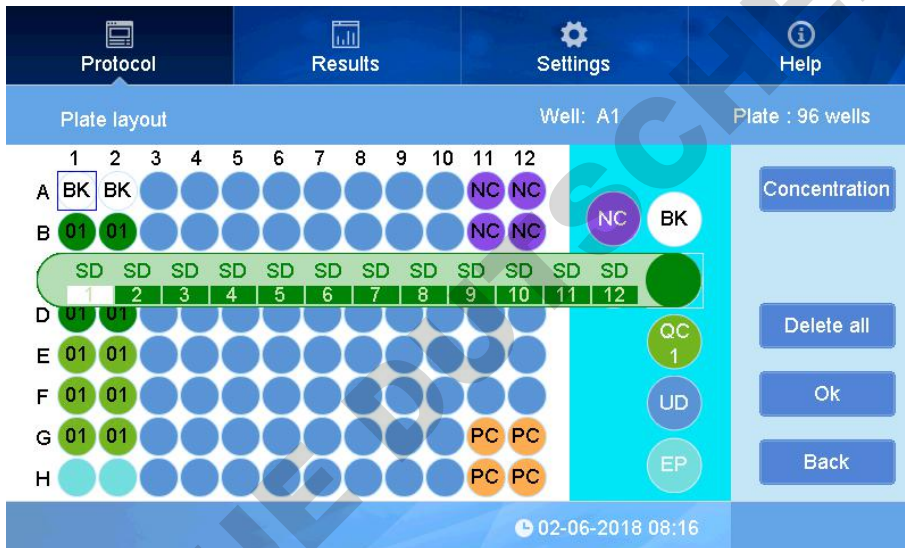

fig 17

At most you can set 12 standard sample positions, and can set several wells with same number.



: QA control well. Setting steps same to standard sample position(Fig 18).

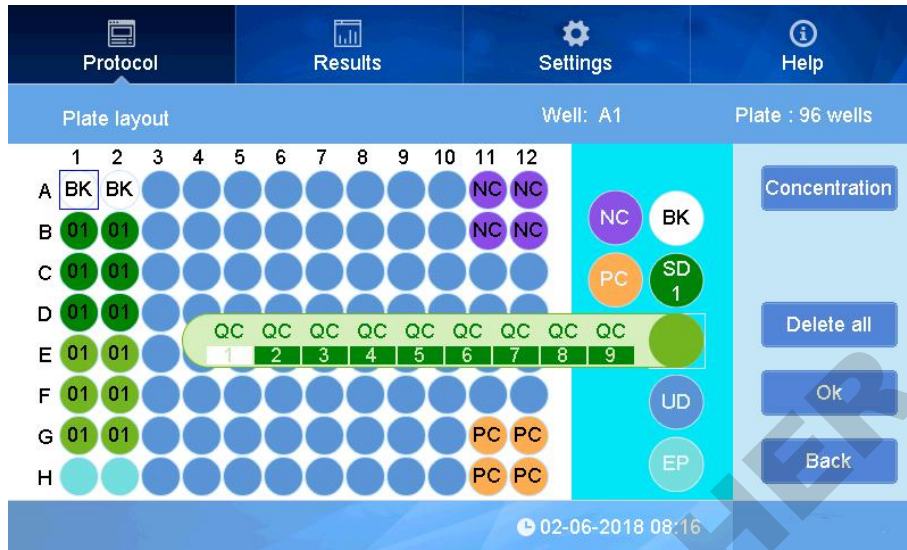

fig 18

You can set 9 QA control positions, and can set several wells with same number.



: Unknown sample position. Set several position as unknown position. Instrument default setting all positions on plate as unknown sample.



: Without sample position, the correspondent positions on microplate are without sample, the measurement result showing EP rather than data.



: Negative control position. Can set several position as negative ones.



: Positive control position. Can set several position as positive ones.

- After setting all position type, press “OK” to return to “protocol” interface and start to measure. If there are standard sample, please input the standard sample concentration and then start to measure.

Note: You can firstly add samples onto microplate and then setting the layout type. You also can do it vice versa.

2.2.2. Standard sample concentration setting

On interface “Plate layout”, press “Concentration” at the right side, you will come to concentration setting interface as below(Fig 19):



fig 19

- It will show all 12 standard samples on this interface, only set the concentration for position which have been set on layout. The ones which have not set on layout will not be measured.
- When setting concentration, only click the correspondent No. to input the concentration value(Fig 20).

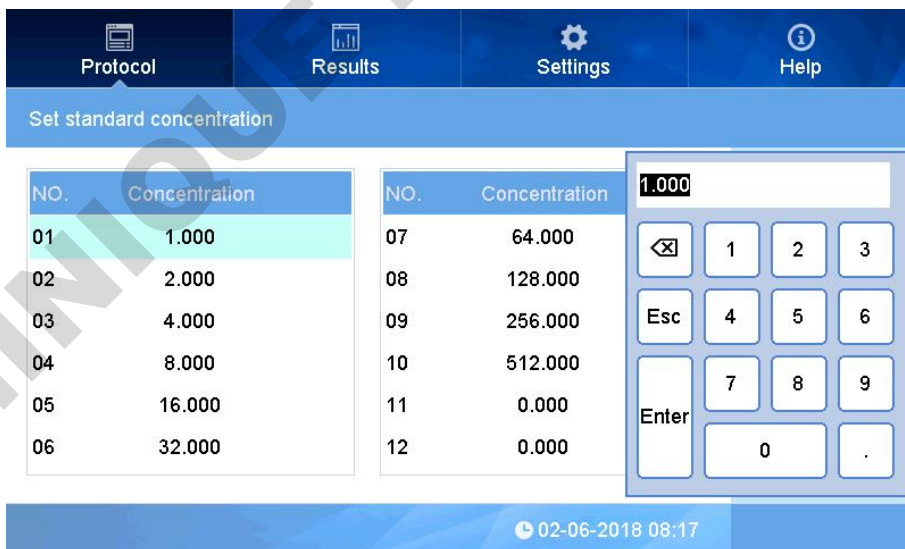

fig 20

Note: make sure the No. of each sample position should be correspondent between layout and microplate and the sample concentration should be correct, any mistake will affect

curve fitting and measurement result.

- “Unit” can set/select by pressing button of ”Unit” at right side(Fig 21).



fig 21

- Press “OK” to confirm and return back to main interface.

2.3. Shake setting

In order to get more precise measurement result, this instrument can shake to make down drops on the wall before measurement.

- On “protocol” interface, click area near “Shake” to “Shake parameters” to set shake function On or Off, speed and time(Fig 22).



fig 22

- Click button right beside “Shake” to choose “On” or “Off”(Fig 23).

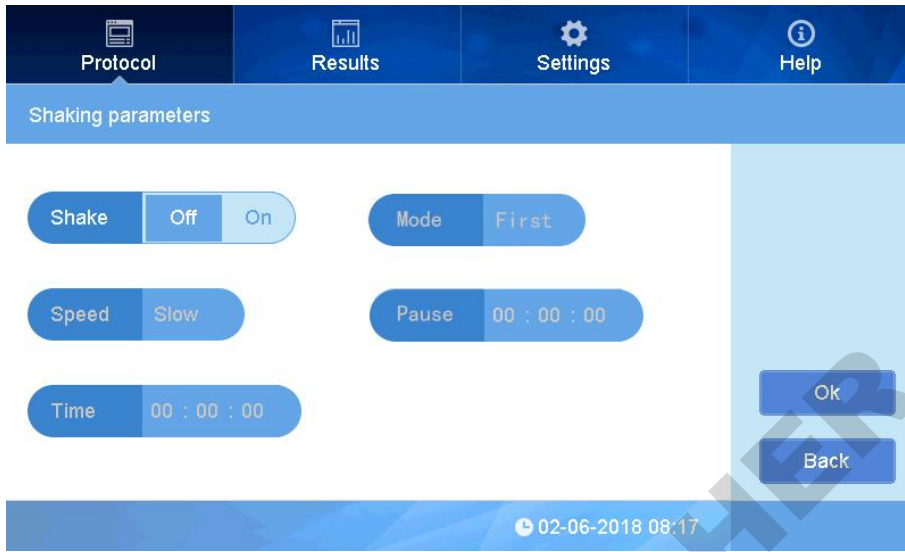

fig 23

- Click button right beside “Speed” to set speed, Slow, Normal, Fast(Fig 24).



fig 24

- Click button right beside “Time” to set time, input numbers to set hour/minute/second(Fig 25).

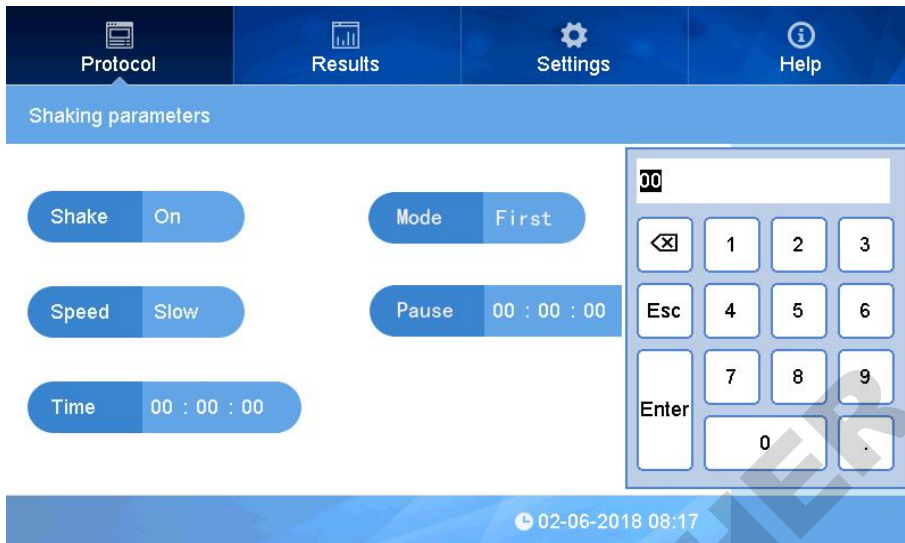

fig 25

- There are two options “First” and “Each” in the “Mode” setting, “First” means only shake in the first testing, “Each” means every test will shake before testing.
- Click "Pause" button to set the waiting time after every shaking which is ahead of testing the absorbance.
- Press **OK** to complete settings, and return back to “protocol” interface.

2.4. Calculate

This part is setting for sample testing result processing method, including Kinetic, Pre-process, Curves.

2.4.1. Kinetic setting

- On interface “protocol”, click white area near “Calculate” to set “Calculate parameters”. Click button right beside Kinetic to choose Open or Close. Set parameters when it is “On”(Fig 26).

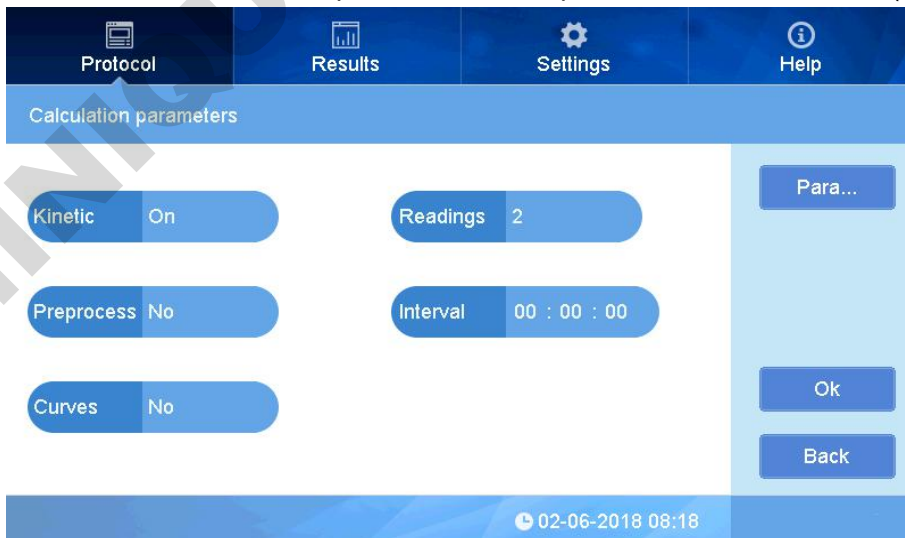

fig 26

- Click button right beside “Readings”, a little keyboard for inputting measurement times.
- Click button right beside “Interval” to set interval of each reading, time format: hour/minute/second.
- At right side of interface , click “Parameters” to set(Fig 27).



fig 27

- Type: There are different Results in report indicating Rate of change, time to change, absorbance rate, due to different types you choose. In case of Kinetic type, average speed, max speed, max time to speed, time to change, max absorbance and max absorbance time. In case of average speed, result will show the average speed of change in absorbance of several detection for each position on plate.
- When at mode of “time to change”, three parameters at right side would be active(Fig 28), set parameters according to experiments.
- Baseline: Baseline setting, Beginning or End are for option.
- Baseline Points: Set baseline point.
- Change: Set change value (The absorbance change is less than setting one will not be recorded).
- First readings: Beginning reading point of data record.
- Last readings: End reading point of data record.



fig 28

2.4.2. Pre-process setting (double wavelength)

In the interface of “Calculate parameters”, click button right beside “Preprocess”, interface comes out as below(Fig 29):

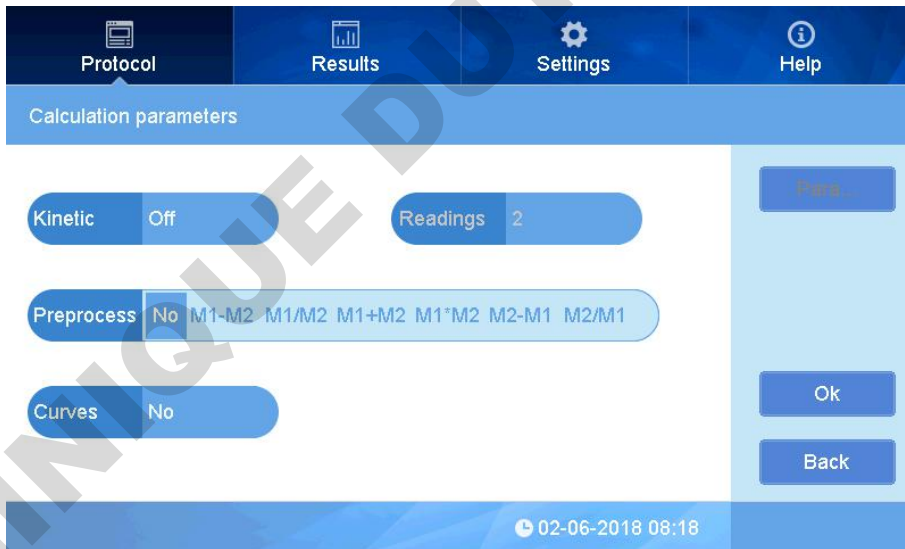

fig 29

You can choose the preprocess method when testing by double wavelength as needed. There are : $M1-M2$, $M1/M2$, $M1+M2$, $M1*M2$, $M2-M1$, $M2/M1$ ($M1, M2$ means absorbance value for two wavelength).

2.4.3. Curves fitting setting

In the interface “Calculate parameters”, click button right beside “Curves”, interface comes out as below(Fig 30):

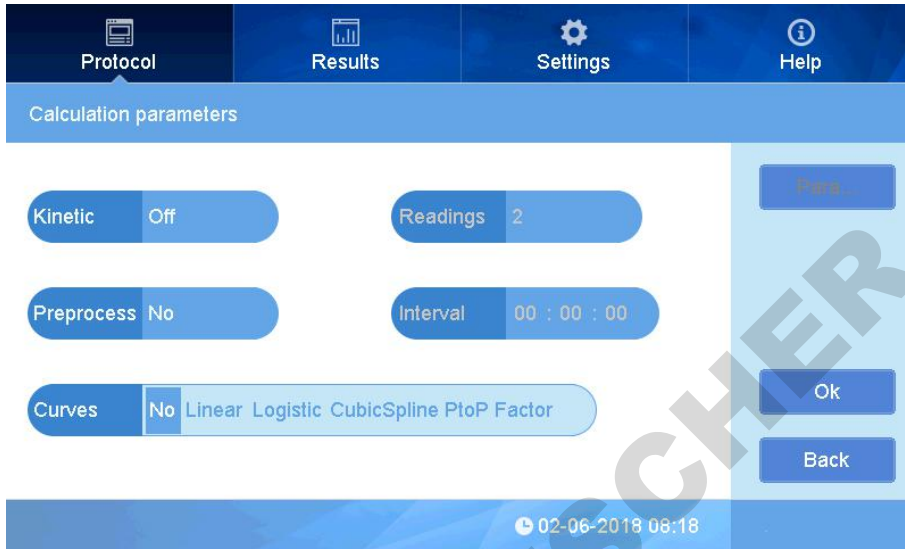

fig 30

Here, you can set curving fitting by different options: linear, logistic, CubicSpline, PtoP, Factor. Choose one type needed, after measurement, software will make curve fitting by sample absorbance value data and input concentration.

2.5. Interpret

● In interface “protocol”, click button right beside Interpret. Choose ”On”, set “Interpret”, interface shows as below(Fig 31):



fig 31

- Click button right beside “source”, choose one from “ABS” and con.(for concentration) as needed. Formula for threshold value “cutoff”: $a \times NC + b \times PC + c$, the “a,b,c” are reagent control coefficient, can be set as needed, “NC” is negative control average value, “PC” is positive control average value.

Click coefficient “a” inputting area to type value which is coefficient needed multiply NC, and confirm by press “OK”, set “b、c” by same way. If “cutoff” needn’t calculate with “PC” or “C”, “b、c” are not required to set, default is zero.

- Weak positive: (+/- Cutoff%) is judged as “weak positive”: Input a value which means the measurement result within Cutoff% and would be judged as week positive. The value comes from the calculation of Weak positive percentage according to the reagent user manual.

- Click symbol “>” to shift “>” or “<” of Positive interpretation to “Cutoff”, set it according to reagent user manual.

- Click “OK” to complete and return to main interface.

2.6. Quality controls setting

- In interface “protocol”, press white area near “Quality”, interface “Quality controls” as below(Fig 32):

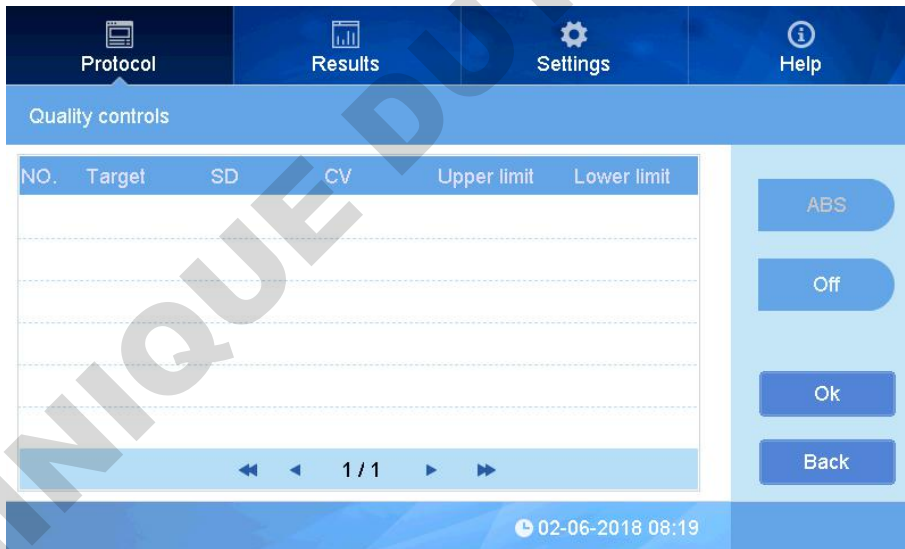

fig 32

- Press button “ABS” to set ABS and conc., can set the control sample ABS or concentration as quality control variables.



fig 33

- Click button “On” to set quality controls function by choosing Open or Close.
- Click “Target” column date to set Quality controls concentration or ABS value, click SD column date to set the standard deviation value for QC concentration or ABS. Set Concentration value, ABS and SD according to reagent user manual.
- When doing Quality controls, set the QC sample on Layout, refer to part of “Layout”.

Section 3 Report

Report interface is for showing you measurement result as well as the history data of latest measurement.

After measurement in interface protocol, software will go to “Report” automatically, showing the current protocol measurement result. Also you can enter by clicking “Report” button.

There are two types on the report: One is ordinary measurement with qualitative and quantitative analysis result. Fig 30, there are data: Raw data, Interpret, Analysis, Curve, QC. And Interpret, Analysis, Curve, QC can be function on or off in protocol setting, when off(close), there will be no results.

1. Ordinary Report interface

1.1 Raw data

Click “**Raw data**” button to view the raw absorbance of the sample(Fig 34). If you have set double-wavelength detection, click “**Filter 1 405nm**” to choose the wavelength.

	1	2	3	4	5	6	7	8	9	10	11	12
A	2.260	1.515	0.051	0.088	0.049	0.103	0.062	0.059	0.070	0.069	3.759	3.456
B	1.384	0.048	0.070	0.057	0.056	0.055	0.058	0.053	0.056	0.066	0.083	0.066
C	0.050	0.064	0.042	0.089	0.051	3.702	0.053	3.231	0.099	0.050	0.069	0.058
D	0.066	0.066	1.301	3.181	0.055	0.066	0.049	0.081	3.182	0.075	0.065	0.073
E	0.056	1.786	0.073	3.325	0.056	2.014	2.861	0.072	0.057	0.055	0.051	0.075
F	0.049	0.063	2.191	3.558	0.049	0.839	1.597	0.055	0.052	0.054	0.070	0.053
G	0.055	0.081	3.189	0.057	0.091	2.053	0.049	0.094	3.046	0.057	0.050	0.076
H	3.223	0.091	0.054	0.063	0.054	0.136	0.065	0.053	0.128	0.053	0.066	0.058

fig 34

Click “**Ex Report**” enter the export report interface(Fig 35,36), click “**Export**”

to export the data you need to the USB flash disk.

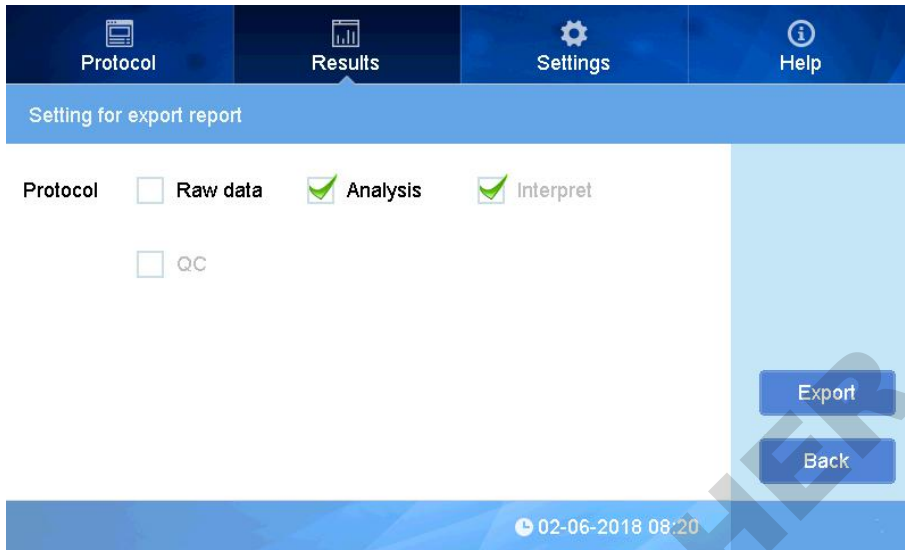

fig 35 End point method export interface

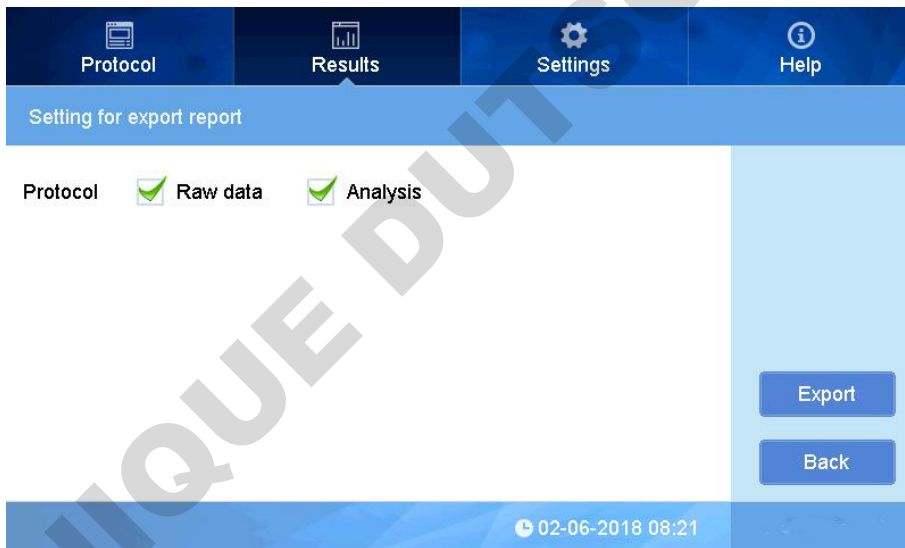



fig 36 Dynamics data export interface

Note: Check the USB flash disk has been inserted in the instrument before export data.

 : Click "Print" button to print the data when connect the thermal printer(Optional).

1.2 Interpret analysis data

Click  to show the current interpret measurement result.

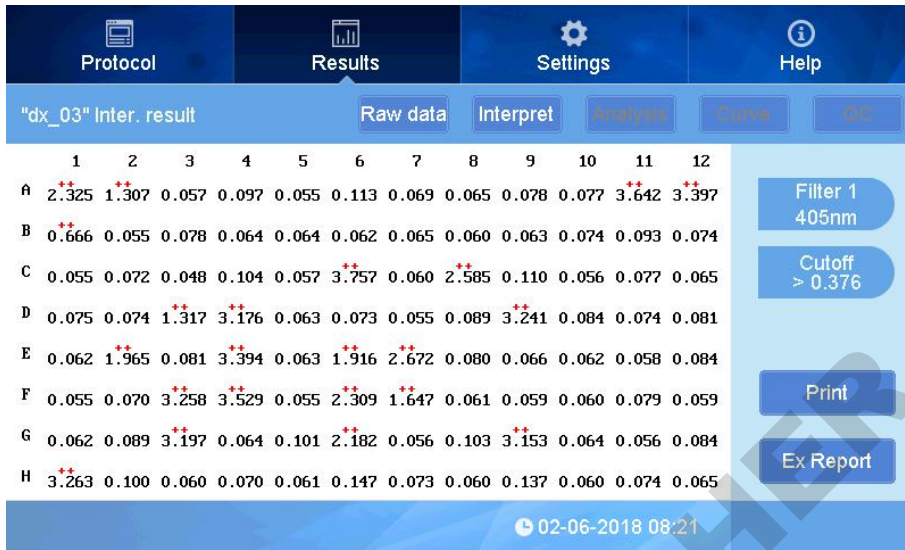

fig 37

Symbol “+” and “++” above each ABS means positive, “++” : positive, “+” : weak positive. Right side shows threshold value “Cutoff”, refer part 2.5 for details(Fig 37).

Note: The print result “P” is positive, “+” is weak positive which is different from the display of the screen.

1.3 Analysis

Click **Analysis** to show the analysis result, there are :

- Concentration : This protocol is not set with kinetic measurement, it is only set as sample concentration calculated according to the standard sample curve by curving fitting. There are also results for standard samples according to the standard curve, this result is different to value input to the Layout(Fig 38).

Linear / Linear

Showing the curving fitting, and pre-process method of the curve fitting which will be introduced in part of “Curve”.

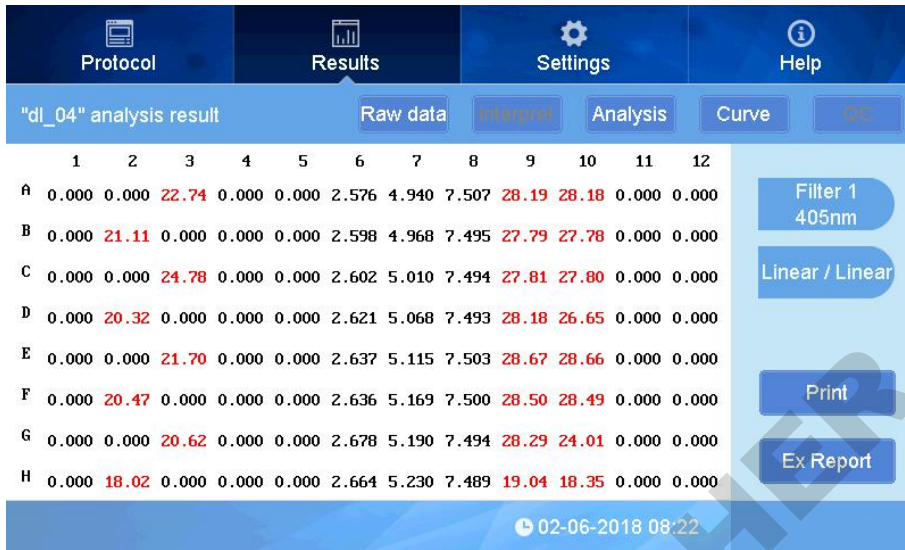

fig 38

1.4 Curves

Standard curve fitting result with formula, you can preprocess the ABS and input standard concentration and then make curve fitting if the previous fitting is not good enough(Fig 39). How to preprocess: Linear/Linear (Linear the ABS and corresponding concentration), Linear/Log(Linear the ABS and corresponding concentration log value), Log/Linear, Log/Log, Log/Linear.

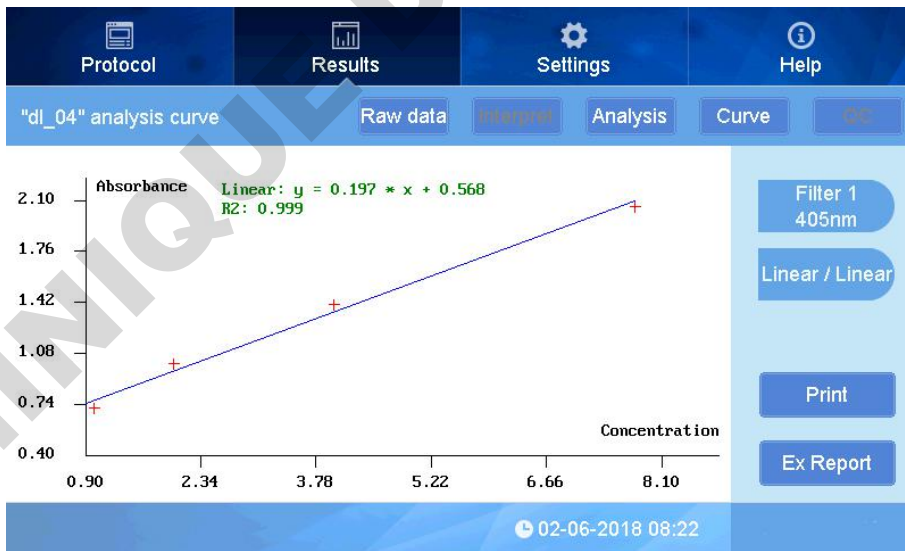

fig 39

1.5 QC measurement result

When protocol setting with QC measurement, the results of QC sample on the plate will come out according to the protocol setting(Fig 40).

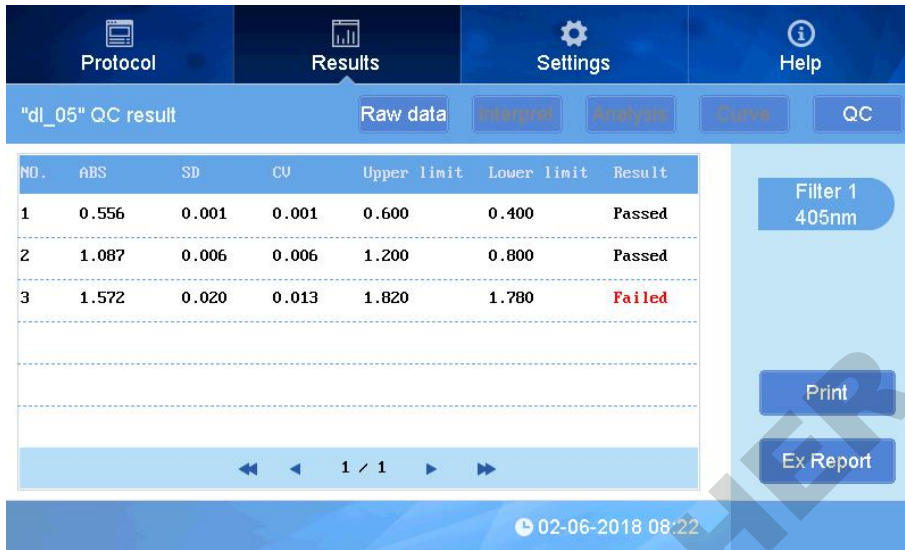

fig 40

2. Kinetics Report interface

2.1 Kinetics measurement Raw data

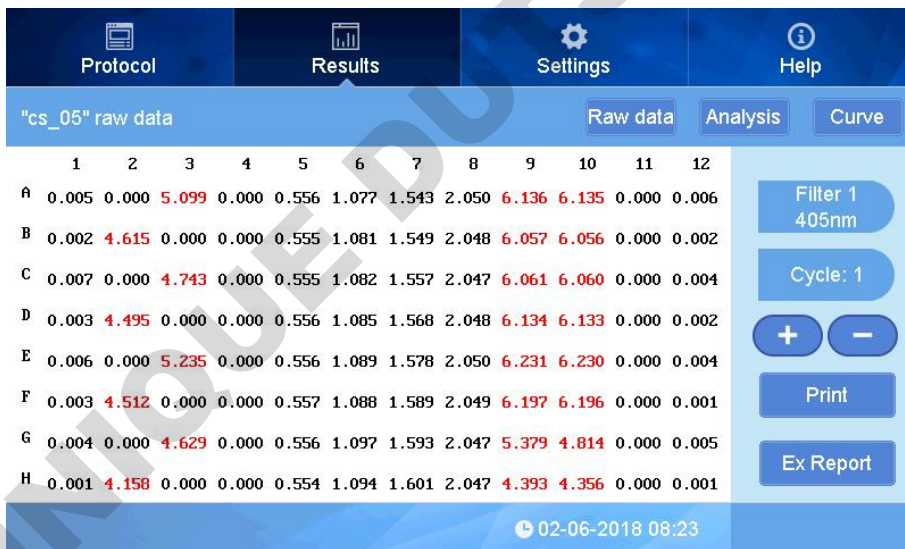

fig 41

The picture above(Fig 41) showing the ABS value under the current measurement cycle, click



to shift the cycles.



indicates the cycle no., click this button and input

cycle no. to shift and check.

2.2 Kinetics measurement Analysis



fig 42



indicating the data process method of kinetics measurement(Fig 42). (See section 2, 2.4.1 Kinetics setting)

2.3 Kinetics measurement Curve



fig 43

It indicates change curve of each sample position ABS detection according to different cycles under kinetics measurement(Fig 43).



Press   to shift sample position on microplate, when at A1 and click  to see absorbance change curve all of sample positions(Fig 44).



fig 44

Section 4 Settings

This part mainly introduces settings of Language, filter, maintenance, print, quality control, screen calibration, date and time.

Click Setting at the upper are of the main interface:



fig 45

1. Language setting

Steps:

- Press "Language" icon in the setting interface :



fig 46

- Click button right beside Language, see picture below :

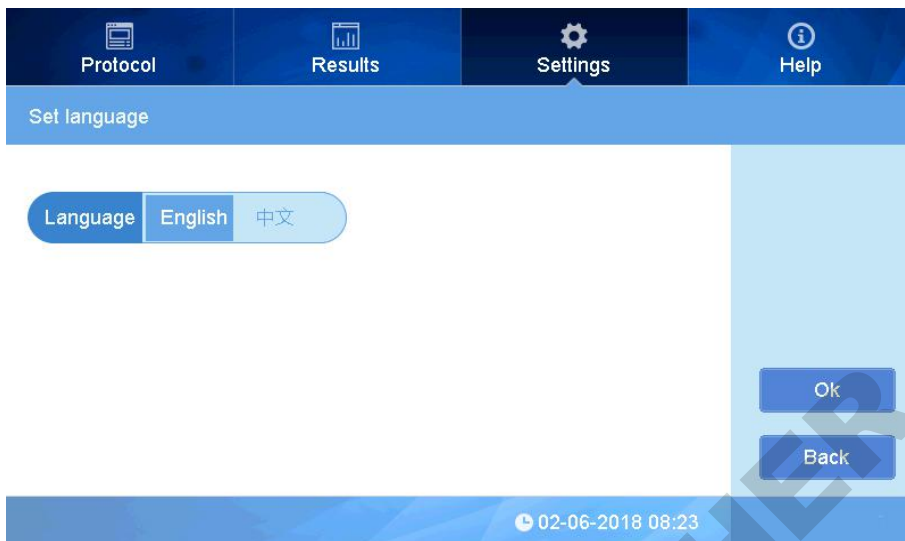

fig 47

Select one language needed and press OK to complete. Now only English and Chinese are available.

2. Filter setting

This instrument is equipped with four standard filters which have positions on the filter wheel from 1-4. Customer also can expand to 8 filters when purchasing instrument as well as after purchase. If the extra filters bought together with instrument, manufacturer would set filter position, no need extra setting. If the extra filters bought after instrument purchase, customer should set by yourself.

Note: Please install filters into instrument prior setting protocol. Please refer to Chapter 4, section 3 for details.

- Click Filter icon in interface of setting(Fig 48).

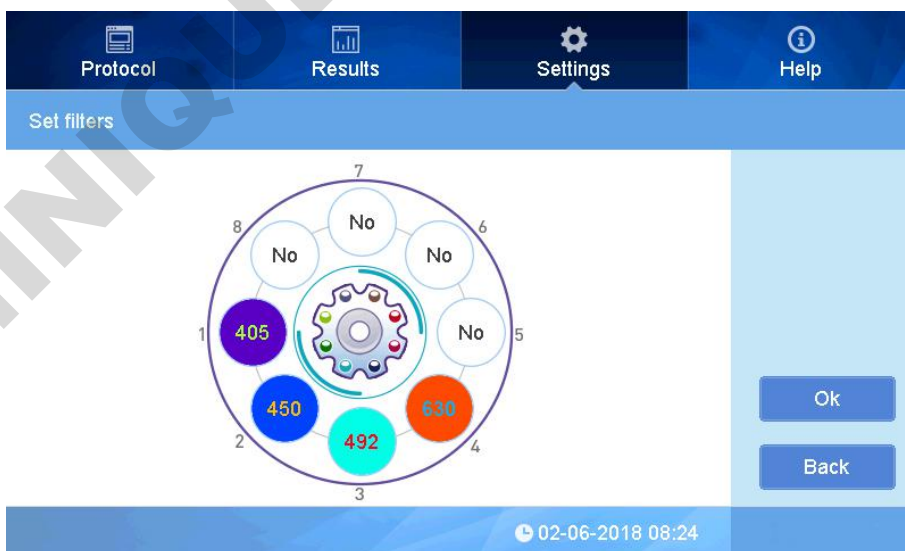

fig 48

- lick the blank position No., input the wavelength, default unit is nm(Fig 49).

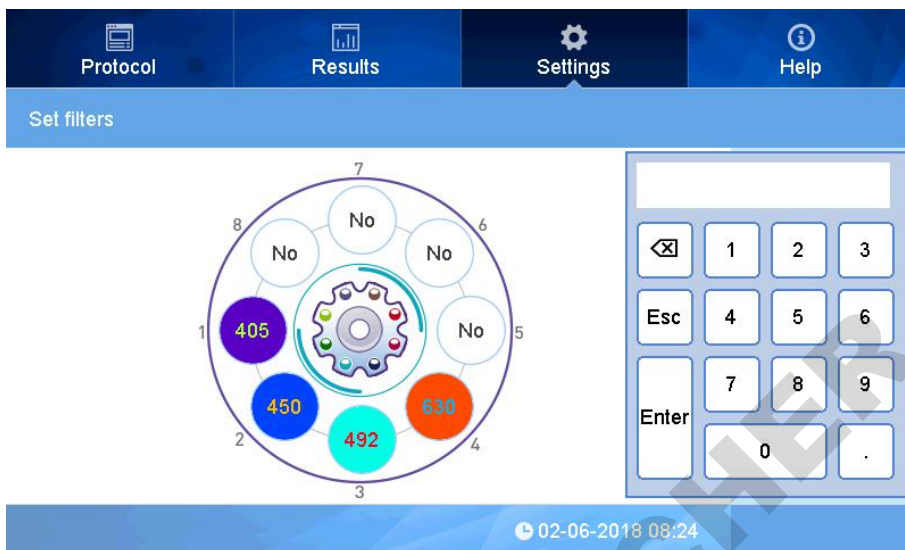

fig 49

In case of wrong input, double click to input again. Standard equipped with 1-4 filter, and the wavelength are as picture above.

Note: The position Nos. in software and filter wheel should be same, or it will lead wrong data.

Click OK to complete after setting.

3. Maintenance

Here you can set microplate holder position, factory set, other maintenance.

- Click “Maintenance” to enter into interface(Fig 50).

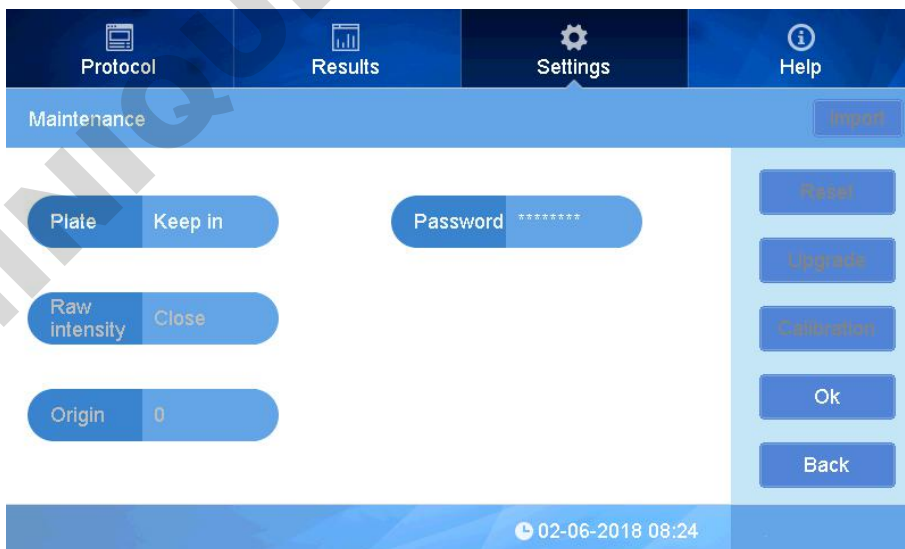

fig 50

● Plate Keep in control microplate holder position in or out of the instrument. Click “Keep in” button to choose “Keep in” or “Keep out” . “Keep in” will make microplate holder in side after measurement, while “Keep out” will make microplate holder come out after measurement.

Reset No this button can reset instrument to factory setting. Choose “Yes”, reset it, but only for the three Demo protocol, the data saved will remain. “Password” is only for factory calibration and maintenance not for users.
Return to main interface by press “OK”.

4. Print setting

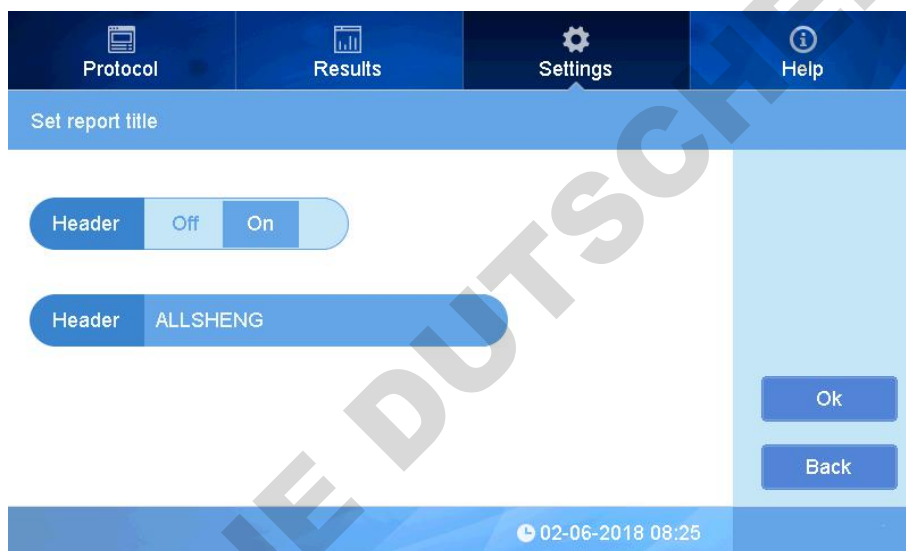

fig 51

Click the right area of “Header” and then click “On” to edit the title of print.

Note: “Print” setting is unavailable for the moment.

5. Time and Date setting

Click “Data & time” to set, Format of Data: month/date/Year, Time: hour:minute:second(Fig 52).

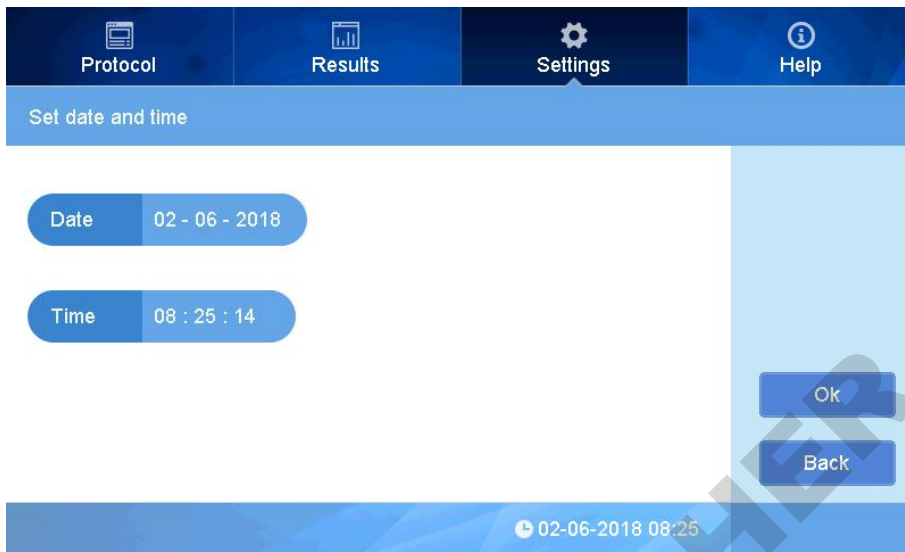

fig 52

In case that you want to change date and time, click the area to set(Fig 53),



fig 53

Click "Enter" to complete setting.

6. Help

Brief introduction every function button as fig 54 below.

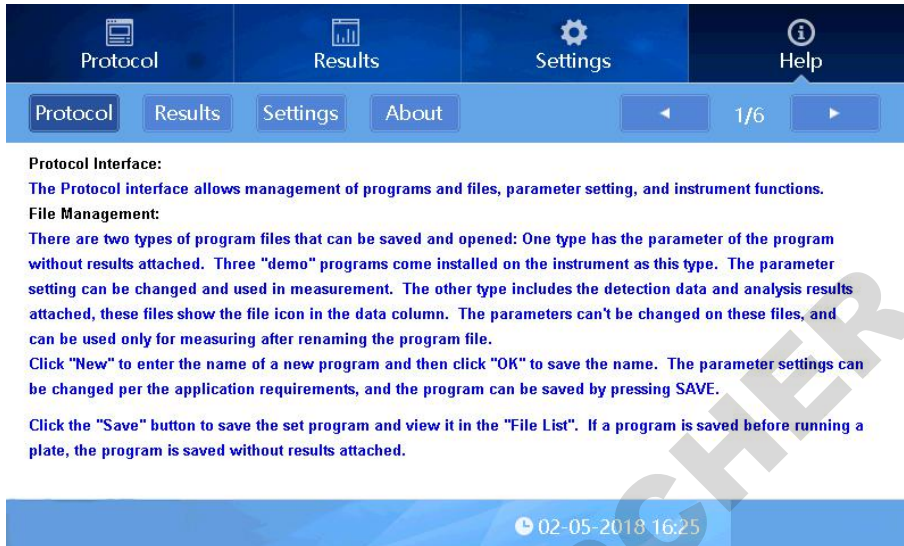

fig 54

- ① Click "Protocol" enter the function introduce interface.
- ② Click "Results" enter the result introduce interface.
- ③ Click "Settings" enter the set introduce interface.
- ④ Click "◀" or "▶" to change the introduce page which is displayed as the "1/6".

Chapter 6 Maintenance, storage, transportation

1. Maintenance

- Keep storage environment dry and clean to prevent moisture, corrosion, away from strong electromagnetic interference sources.
- Instrument already calibrated before leave factory. User is not allowed to disassembly and make adjustment. Any defectiveness, please contact manufacturer.
- Continuous emergency turning on/off is not allowed.
- Make sure apply the device with correct input voltage scope.
- Parts replacement.

Reliability and effectiveness of the basic components for the instrument are tested to ensure quality, as well as structural design and machine design also taken during developing process. In normal use, there is no need to replace the regular functional parts, while some special parts need to be replaced if necessary.

1) Light source replacement

Contact manufacturer for a new light source once light source life cycle is over after long term usage. Replacement steps as below, (make sure cut off power supply before replace)

- a. Open the back door of the instrument, light source showed as Fig 55, loose screws on light source connection by a small screw driver, remove connection upwards.
- b. Loose light source fixing plate and remove it, remove the light source upward and take out from the instrument. (Caution to the high temperature light source)
- c. Replace a new light source by reverse steps, pay attention to the position of the light on the light source part, loaded flat and stable then fix the fixing plate (Fig56).

Note: Don't touch the surface of the lamp, holding at the lamp base when replace with uniform force, avoid damage.

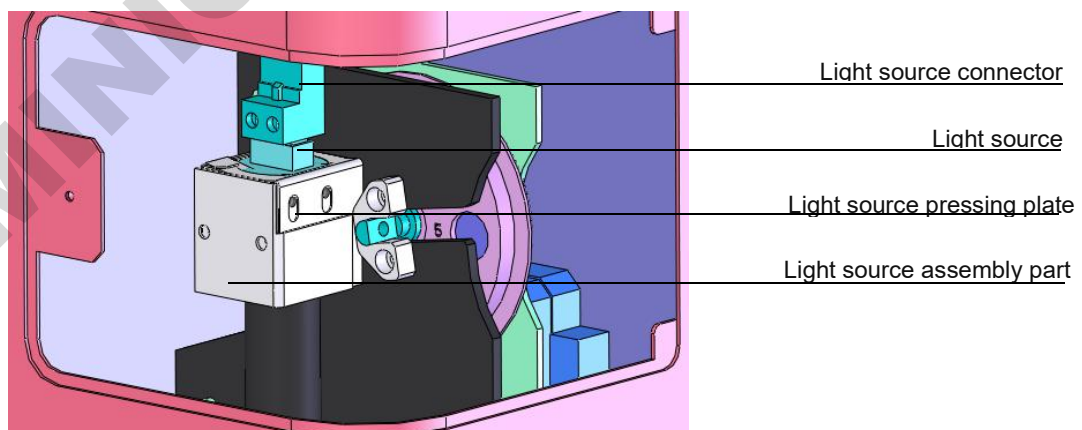

fig 55

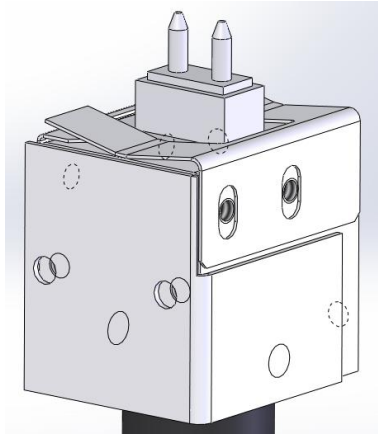

fig 56

2) Install optical filter

Instrument is equipped with four standard filter inside, in case of need other wavelength, please operate as following steps, turn off the instrument before changing filter.

- a. Loosen the knob to open the back door, take out the optical filter wheel by the equipped allen wrench(Fig 57).
- b. Take off the fixing plate on wheel and put the optical filters onto the wheel and fix filter by fixing plate. Arrows on filters should be same as light incident direction(Fig 58).
- c. Load the wheel to slot with number marks outward, and fix the wheel on slot.

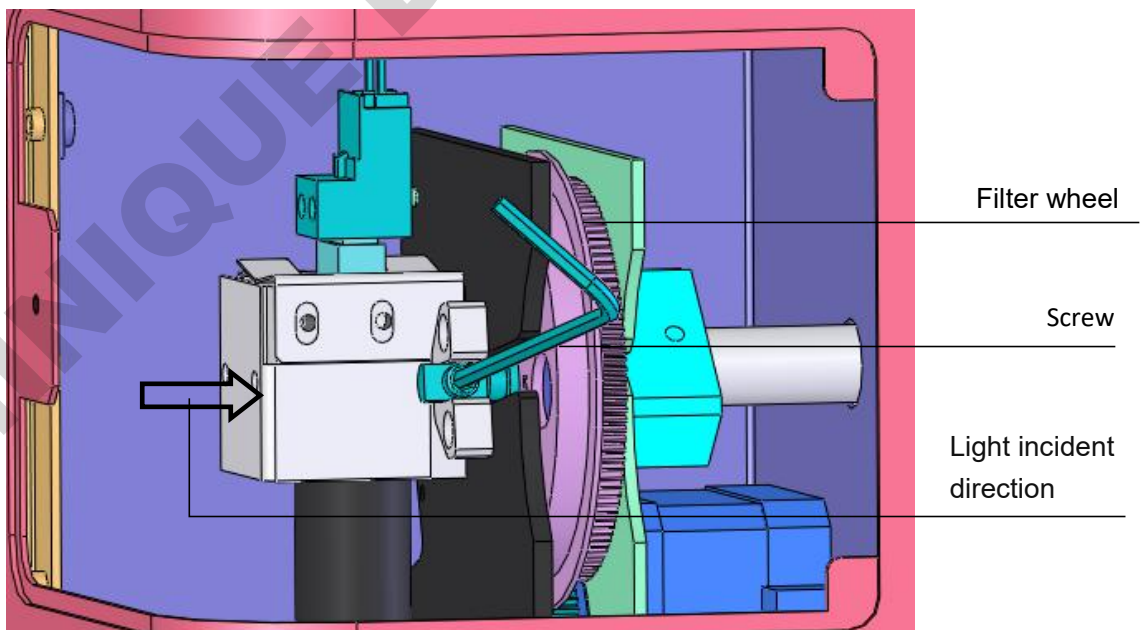

fig 57

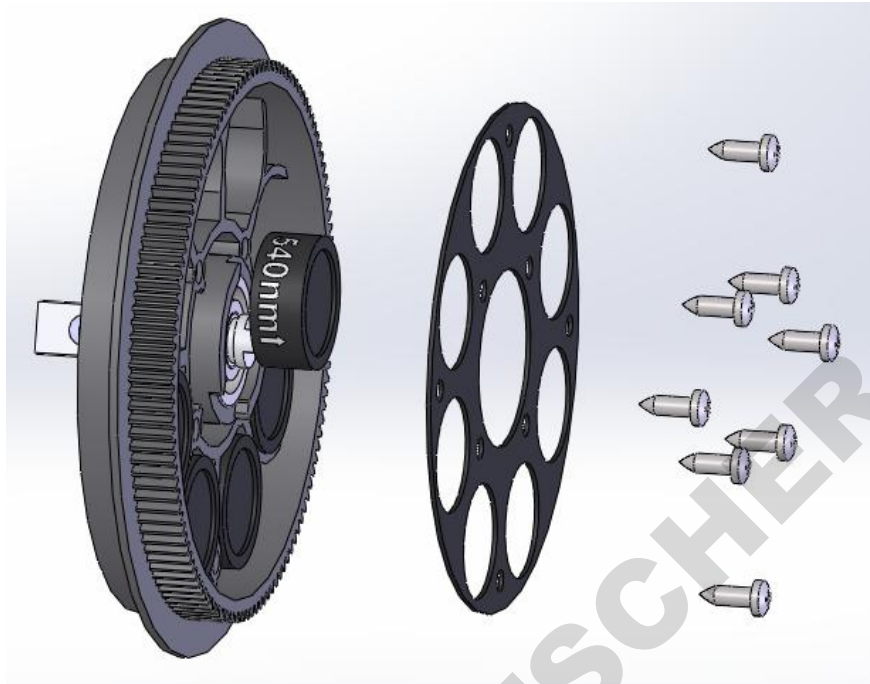

fig 58

Note:

- Instrument is equipped with four standard filter inside, please ignore this step if you don't need other filters.
- Other filters besides standard ones need to be purchased separately.
- Don't touch filter to avoid contamination or affect the precision.
- Don't touch any other mechanical or electric part when installing the filter wheel.

2. Storage and transportation

1. Storage in room temperature $-10^{\circ}\text{C}\sim 40^{\circ}\text{C}$, relative humidity less than 80%, without corrosive gas and with good ventilation.
2. Avoid heavy shock, vibration, and humidity during transportation.

Chapter 7 Trouble shooting

No	Fault phenomenon	Possible Causes	Solutions
1	Instrument can not start	Power defective	Check power supply, Check cable plug status, Check fuse, Check voltage
2	Lamp not on	Power to lamp failure, Lamp defective	Check power before replace, Replace a lamp
3	Weak light	Lamp defective	Replace lamp
4	No reset signal of microplate	Photoelectric switch defective	Replace photoelectric switch
5	Measurement result with big deviation or no result. Filter wheel does not work, or turn too much before stopping.	Filter wheel photoelectric switch defective	Replace Filter wheel photoelectric switch
6	Microplate does not move forward or no backward.	There is obstacle stops it	Check microplate holder
7	Measurement result not precise	Microplate is not placed smooth and steady	Check if microplate placed steady or not.
8	Start measurement is interrupted	Communication interrupt.	Press "stop", restart to measure.
9	Strong light	Software add new filter, but without filter on wheel.	Delete the filter setting which is not needed.

Chapter 8 Accessories

No.	Item	Specs	Unit	Qty	Remark
1	Power cord		PCS	1	
2	Touch pen		PCS	1	
3	Mouse	Logitech	PCS	1	
4	Cross screwdriver	SATA 62307	PCS	1	Install or remove filter
5	Allen wrench	2.5mm	PCS	1	Install or remove filter wheel
6	Certification		PCS	1	
7	Operation Manual		PCS	1	
8	Performance test statement		PCS	1	
9	Packing List		PCS	1	
10	U-Disk	8G	PCS	1	

Standard equipped with four filters: 405nm, 450nm, 492nm, 630nm.

Memo

DOMINIQUE DUTSCHER SAS