



The OD600 DiluPhotometer™ User Manual

Version 1.6





Implen GmbH · Schatzbogen 52 · D-81829 Munich

Declaration of Conformity

This is to certify that the Implen OD600 DiluPhotometer™ conforms to the requirements of the following directives:

2014/35/EU	Low Voltage directive (LVD)
2014/30/EU	Electromagnetic Compatibility directive (EMC)
2011/65/EU	Restriction on the use of certain hazardous substances directive (RoHS)
2012/19/EU	Waste electrical and electronic equipment directive (WEEE)
2006/42/EC	Machinery directive

Standards used to demonstrate conformity include:

EN 61010-1:2010	Safety requirements for electrical equipment for measurement, control and laboratory use, General Requirements
EN 61010-2-101:2002	Safety requirements for electrical equipment for measurement, control and laboratory use.
EN 61326-1:2013	Electrical equipment for measurement, control and laboratory use –EMC requirements (class B)
EN ISO 12100:2010	Safety of machinery-General principles for design, risk assessment and risk reduction

Signed:

Dated: October 18, 2021



Dr. Thomas Sahiri
Managing Director
Implen GmbH

TABLE OF CONTENTS

1.	ESSENTIAL SAFETY NOTES	4
1.1	Unpacking, Positioning and Installation	4
2.	INTRODUCTION	5
2.1	Your Spectrophotometer	5
2.2	Sample Handling Tips	5
2.3	Keypad and Display	6
3.	DILUCELL™	7
3.1	Description	7
3.2	Operation Instructions	7
3.3	Specifications	8
4.	OD600 DILUPHOTOMETER™ - DILUCELL™ APPLICATION	9
4.1	Bacterial Cell Culture Measurement	9
4.1.1	Description	9
4.1.2	Operation Instructions.....	9
5.	OD600 DILUPHOTOMETER™ - STANDARD CUVETTE APPLICATION	11
5.1	Protein Quantification with Bradford Assay	11
5.1.1	Description	11
5.1.2	Operation Instructions.....	11
6.	TROUBLE SHOOTING NOTES	12
7.	ACCESSORIES	13
8.	MAINTENANCE	13
8.1	Cleaning and General Care of the Instrument.....	13
8.2	De-contamination Procedure	13
9.	SPECIFICATION AND WARRANTY	14

1. ESSENTIAL SAFETY NOTES

1.1 Unpacking, Positioning and Installation

- Check the contents of the pack against the packing list. If any shortages are discovered, please inform your supplier immediately.
- Inspect the instrument for any signs of damage caused in transit. If any damage is discovered, please inform your supplier immediately.
- Ensure your proposed installation site conforms to the environmental conditions for safe operation:
Indoor use only
Temperature 5°C to 35°C
Maximum relative humidity of 80 % up to 31°C decreasing linearly to 50 % at 40°C
- The instrument is powered by the internal rechargeable battery or by mains electricity using the supplied power-adaptor. Using the instrument with the mains adapter will automatically recharge the battery.
- The battery will last approx. 1 month when fully charged with normal use.
- A full battery recharge will take approx. 12 hours (overnight).
- Please read through this user manual prior to use.
- Please contact your original supplier in the first instance if you experience technical or sample handling difficulties.

If this equipment is used in a manner not specified or in environmental conditions not appropriate for safe operation, the protection provided by the equipment may be impaired and instrument warranty withdrawn.

2. INTRODUCTION

2.1 Your Spectrophotometer

Your OD600 DiluPhotometer™ is a small, easy to use instrument that is dedicated to measuring samples at a wavelength of 600 nm. It is suitable for measuring growth rates of all types of cell (e.g. *E. coli* and yeast). Combining OD600 DiluPhotometer™ with DiluCell™ 10 facilitates measurements with low sample volumes of 300 µl and a virtual sample dilution of factor 11.

With a bandwidth of 40 nm the OD600 DiluPhotometer™ enables also measurements nearby 600 nm like the protein quantification assay according to Bradford (595 nm).

A 600 nm LED source in combination with a fibre optic is used to obtain the measurement. The instrument can be used in incubation cabinets and under anaerobic conditions.

2.2 Sample Handling Tips

- Note that the light beam is directed horizontal from the front of the instrument to the back; therefore please ensure the cell is inserted in the correct alignment.
- The optical height is 8.5 mm.
- The cell holder supplied with the instrument accepts:

	Pathlength	min. Volume	virtual Dilution	Adapter
DiluCell™ 10 (8.5 mm center height)	0.9 mm	300 µl	1:11	No
Macro cuvette (max fill volume 4.5 ml)	10 mm	1 ml	No	No
Semi-micro cuvette (max fill volume 1.4 ml)	10 mm	0.5 ml	No	No
10 mm diameter tubes	n/a*	0.9 ml	No	Yes
12 mm diameter tubes	n/a*	1.1 ml	No	Yes
16 mm diameter tubes	n/a*	2.2 ml	No	No

*Depends on tube being used.

IMPORTANT WARNING

Always wear protective clothing when handling bacteria or other cells.

2.3 Keypad and Display

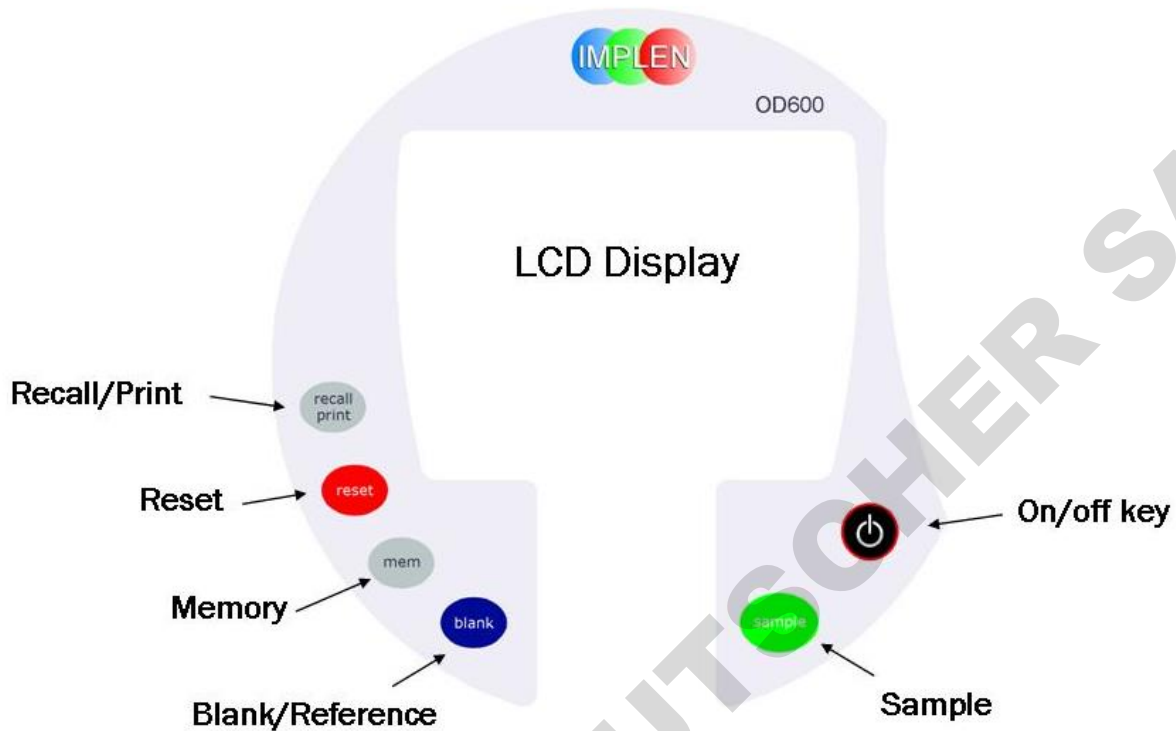

Key	Action
On/Off key 	Turns the instrument on/off
Blank	Set reference to 0.000 OD at 600 nm on a reference
Sample	Take a measurement
Mem	Memory button
Reset	Press twice to clear stored values
Recall / Print	Print results stored in memory
Display	There is a memory number indicator and a battery indicator

3. DILUCELL™

3.1 Description

DiluCell™ is designed for the usage of the OD600 DiluPhotometer™ for the analysis of samples at a wavelength range of 340 nm to 950 nm. Due to the reduced pathlength, DiluCell™ provides a virtual dilution without the need of a physical dilution of higher concentrated samples.

DiluCell™ 10 allows an automatic 1/11 dilution of the sample at a center height of 8.5 mm. The required sample volume is 300 µl.

The following scheme explains the functionality of the DiluCell™ technology:

Lambert-Beer-Law:

$$Abs = \log \frac{I_0}{I} = \epsilon \times c \times d$$

Abs = measured absorbance value on your instrument screen

I_0 = incoming light

I = outgoing light

ϵ = extinction coefficient

c = concentration

d = pathlength (standard 1 cm / 15 mm center height)

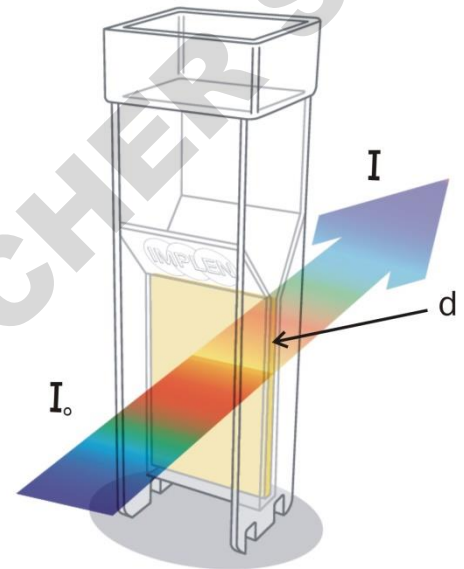

IMPLEN DiluCell™

3.2 Operation Instructions

Step 1 Place the DiluCell™ into the cuvette sample compartment. Ensure the correct positioning of the DiluCell™. The light beam of the OD600 DiluPhotometer™ is directed horizontal from the front of the instrument to the back.

Important Note: DiluCell™ will not work in any other orientation; do not mix other cuvette types within a DiluCell™ measurement series (for blank, etc.).

Step 2 Pipette your reference or sample into the DiluCell™. DiluCell™ is very easy to fill; the geometrical setup supports air bubble free sample application. It is recommended however that you check for air bubbles before the measurement. In case of an air bubble in the cell please remove it by gently tapping the cell.

Volume requirement is: 300 µl for DiluCell™ 10

Important Information:

Remember to multiply the reading from the OD600 DiluPhotometer™ after the measurement with the proper virtual dilution factor:

Virtual dilution factor is: 10 for DiluCell™ 11

Important Note: It is not recommended to reuse DiluCell™ due to:

- high probability of cross contamination
- high probability of air bubbles when refilling the cell
- decontamination not easily possible (for cell culture measurements, e.g.)

3.3 Specifications

	DiluCell™ 10
Material	PMMA
Wavelength Range	340 nm - 950 nm
Volume Requirement	300 µl
Pathlength (at 8.5 mm center height)	0.9 mm
Tolerance	+/- 10%
Ordering Information (pack with 96 cells)	DC 10

Limitations

Do not autoclave DiluCell™.

The DiluCell™ is approved only for the usage with the OD600 DiluPhotometer™.

For solvent compatibility please contact your local Implen partner or the Implen Team at www.implen.de.

DOMINIQUE DUTSCHER SAS

4. OD600 DILUPHOTOMETER™ - DILUCELL™ APPLICATION

4.1 Bacterial Cell Culture Measurement

4.1.1 Description

- The stage of growth of a bacterial culture needs to be monitored to ensure that the cells are harvested at the optimum point for the greatest density of live cells. An exemplary growth curve is given below. Cells should be harvested towards the end of the log phase. The optical density of the sample indicates when this point has been reached. This value varies dependent on the cells being grown. Routinely the cells are grown until the absorbance at 600 nm (known as OD 600) reaches approximately 0.4 prior to induction or harvesting. A linear relationship exists between cell number (density) and OD 600 up to approx. 0.6.

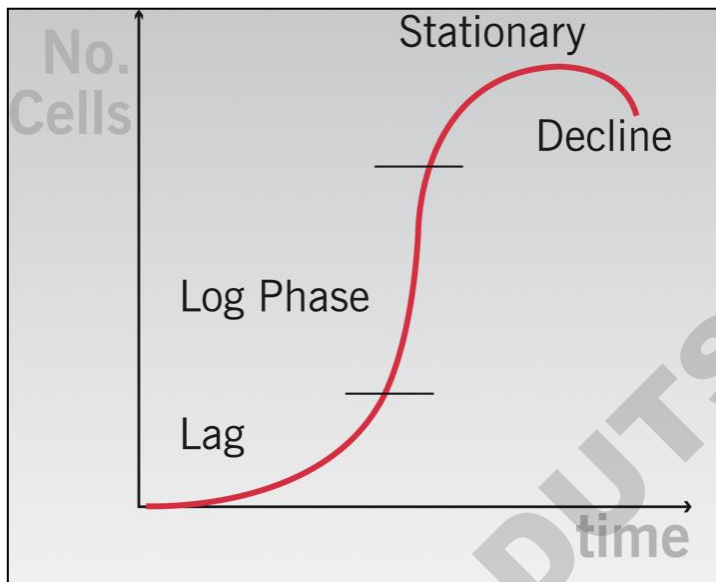

- It is important to note that for turbid samples such as cell cultures, the absorbance measured is due to light scattering, and not the result of molecular absorption. The amount of scatter is affected by the optics of the system (distance between the cell holder and instrument exit slit, geometry of this slit and the monochromator optics). Different spectrophotometer types therefore give different responses for the same turbid sample; to compare results, they must be normalized using calibration curves.
- A calibration curve can be determined by comparing measured OD 600 to expected OD 600. Expected OD 600 is determined by counting cell number using an alternative technique (for example microscope slide method) and converting to OD 600 using the rule of thumb that 1 OD 600 = 8×10^8 cells/ml for *E. coli*. Clumping together of cells will also affect readings, so the medium they are suspended in will also make a difference.

4.1.2 Operation Instructions

Making a measurement:

- Step 1** Switch the instrument on by pressing the **ON/OFF**  button.
- Step 2** Place a reference into the cuvette compartment.
- Step 3** Press the **blank** button. The display will show 0.00.
- Step 4** Remove the reference and replace with the sample solution in a cuvette.
- Step 5** Press the **sample** button. The display will show the OD of the sample in absorbance units.

Important Information:

If using DiluCell™ remember to multiply the reading from the OD600 DiluPhotometer™ after the measurement with the proper virtual dilution factor:

Virtual dilution factor is: 10 for DiluCell™ 11

Multiple samples can be compared with the same reference by placing different samples in the cuvette chamber and making measurements for each one. It is recommended to re-reference with the reference solution every 10 to 15 minutes to avoid any slow instrument drift. Please re-reference always if in doubt.

Using the memory function

The instrument can store up to 99 readings in the memory. The results can then be viewed, printed or downloaded at a later time. This enables readings to be taken at, for example, an incubator and downloaded to a PC in a different laboratory. The results remain in the memory even when the instrument is switched off.

- Step 1** Switch the instrument on by pressing the **ON/OFF**  button.
- Step 2** Press **mem** button to display MEM (if not already displayed).
- Step 3** Place a reference into the cuvette compartment.
- Step 4** Press the **blank** button. The display will show 0.00 but the memory number will not change.
- Step 5** Insert the sample and press the **sample** button. The result will be displayed and automatically stored and the Memory Number will increase by one.
- Step 6** To retrieve the results press **recall/print**. This will print out all of the results held in the memory if the instrument is connected to a PC or printer and cause the memory number to flash. Repeated pressing of the button will display the results in the memory on the screen in reverse order scrolling back to the beginning.
- Step 7** Press **reset** or **mem** to go back to the latest result.
- Step 8** Pressing **reset** when the latest result in the memory is showing will cause the screen to flash "rSt and?".
- Step 9** If no further action is taken the screen will revert to its normal state after 7 seconds. If **reset** is pressed again whilst the screen is flashing all of the memory positions will be cleared.

Important Note: The instrument can store up to 99 readings.
The hundredth reading will automatically overwrite the first reading.

5. OD600 DILUPHOTOMETER™ - STANDARD CUVETTE APPLICATION

5.1 Protein Quantification with Bradford Assay

5.1.1 Description

Bradford Assay is a rapid and accurate method used to determine the total protein concentration of a sample by quantifying the binding of a dye, Coomassie Brilliant Blue G-250, to an unknown protein. The assay is based on the observation that the absorbance maximum for an acidic solution of Coomassie Brilliant Blue G-250 shifts from 465 nm to 595 nm when binding to protein occurs. By comparing this binding to that of different, known concentrations of a standard protein, the concentration of the unknown protein can be calculated. Standard curves with bovine serum albumin (BSA) are given below as an example.

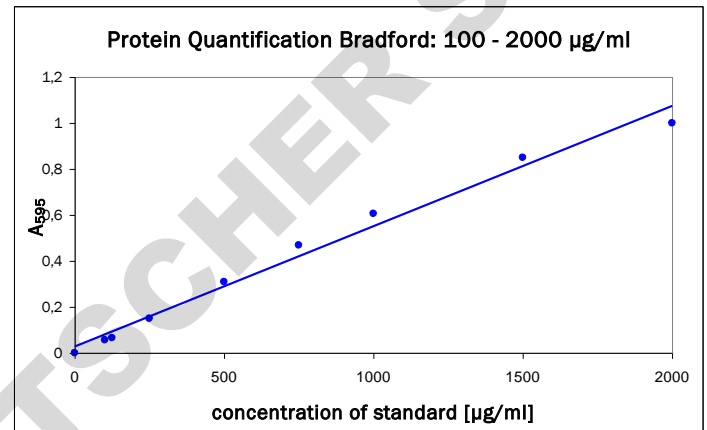
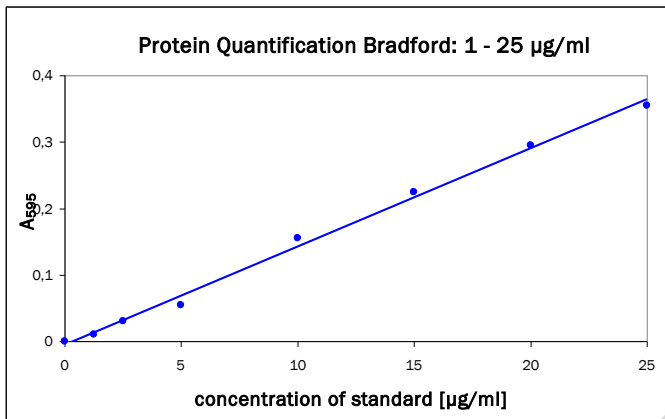

5.1.2 Operation Instructions

Important Note:

Please follow the detailed protocols supplied with your Bradford assay kit to ensure accurate results.

Making a measurement:

- Step 1** Switch the instrument on by pressing the **ON/OFF**  button.
- Step 2** Place a reference into the cuvette compartment.
- Step 3** Press the **blank** button. The display will show 0.00.
- Step 4** Remove the reference and replace with standard solutions.
- Step 5** Press the **sample** button. The display will show the OD of the standard solutions in absorbance units.
- Step 6** Create a standard curve.
- Step 7** Measure the absorbance of sample solutions.
- Step 8** Determine the protein concentration of unknown samples according to the standard curve.

6. TROUBLE SHOOTING NOTES

ERROR INDICATION	SOLUTION
A flashing Absorbance reading of 2.00 Abs is obtained.	This indicates an Absorbance of more than 1.99 and is therefore out of range. The sample needs to be diluted or use DiluCell™ 10 for virtual dilution.
A negative reading is obtained.	In normal measurements the test sample has a positive Absorbance compared to that of the Reference. Negative readings will be obtained if the Reference and Test cuvettes are mixed up.
A flashing Absorbance reading of – 0.30 Abs is obtained.	This indicates an Absorbance of less than –0.30 Abs and is therefore out of range. You need a higher concentrated sample.
Unexpected results are obtained.	Any bubbles in solution will produce considerable error. Check LED is flashing
REF is displayed when sample is pressed	The baseline has not been set. Replace the sample with a blank or reference and press blank. The samples can then be tested.
No reading is obtained when using the instrument in battery mode.	Check that there is sufficient battery power available. The battery power available is indicated by the battery symbol at the bottom right hand corner of the display. Three bars in the battery indicate that it is fully charged. If only one or no bars are present the battery needs to be recharged. Connect the instrument to the electric power supply using the adaptor/recharge unit. The battery will be fully recharged in 12 hours.
The OD600 DiluPhotometer™ value is different to that obtained on another instrument in the lab.	When you measure turbid solutions you do not measure the absorbance/transmittance of light at the detector, you measure the amount of scattered light that reaches the detector. Thus optical geometry is very important - the further the distance from the sample to the detector, the greater the effect of the scattered light. Thus instead of harvesting at 0.4 OD, for example, you have do it at 0.8 OD. A simple conversion factor can be calculated from the OD 600 of your existing instrument compared to that of the OD600 DiluPhotometer™ instrument. for further information see also Technical Note #8 OD600.

7. ACCESSORIES

DiluCell™ 10
Adapter set for 10 and 12 mm tubes

DC 10
OD600-AT

8. MAINTENANCE

8.1 Cleaning and General Care of the Instrument

The instrument has no serviceable parts.

The instrument requires little maintenance, but the following are considered good practice:

1. Keep the instrument clean and dry. Wipe off any spilt liquids immediately. Clean with a slightly damp cloth; a non-abrasive water-based soap or detergent may be used. The instrument may be wiped.
2. Remove the cuvettes from the instrument when not in use.
3. Store in a cool place away from corrosive chemicals or fumes.

8.2 De-contamination Procedure

To decontaminate we recommend that the instrument is wiped with ethanol or other antibacterial detergent as required. A soaked cloth may be inserted into the cuvette chamber or ethanol sprayed directly into the compartment.

The instrument can be sterilised using formaldehyde or ethylene oxide, but not with UV light (due to plastic degradation).

For severe contamination it is possible to remove the 4 screws in the base and separate the top and bottom covers (taking care to not drop the battery inside the instrument). The contaminated areas in the instrument may then be wiped with a suitable anti-bacterial detergent.

9. SPECIFICATION AND WARRANTY

Technical Specification

Wavelength	600 nm
Bandwidth	40 nm
Range	Optical Density –0.3 A to 1.99 A
Accuracy	<±0.05 A at 1 A using Neutral Density Filters
Repeatability	±0.02 A at 1 A
Controls	6 button – power, blank, sample, memory, reset, recall/print
Optical height	8.5 mm
Cuvette holder	Fixed with drain hole. Accepts DiluCell™10, 10 mm pathlength semi micro and macro cuvettes or 14-16 mm round tubes.
Output	RS232, USB
Memory	99 readings
Display	Custom LCD
Power requirements	External power adaptor (110 to 220 V, 50/60 Hz, 20 VA) or internal rechargeable NiMH battery
Approximate dimensions	180 x 150 x 60 mm
Weight	0.6 kg

Specifications are measured after the instrument has warmed up at a constant ambient temperature and are typical of a production unit. As part of our policy of continuous development, we reserve the right to alter specifications without notice. The product does not fulfil the specific requirements of the IVD.

Warranty

IMPLEN guarantees that the product supplied has been thoroughly tested to ensure that it meets its published specification. The warranty is as defined in our current terms and conditions and is only valid if the product has been used according to the instructions supplied. IMPLEN or your supplier can accept no liability for loss or damage, however caused, arising from the faulty or incorrect use of this product.