



Intelligent Evaporation

Leading Safety Standards

Superior Ease of Use

Reduced Cost of Ownership

Operating Manual

Page 2

Rotary Evaporator Hei-VAP Value, Hei-VAP Value Digital, Hei-VAP Advantage

Operating manual must be read before initial start-up. Please follow the safety instructions provided. Please keep for future reference.

Original-Betriebsanleitung

Page 58

Rotationsverdampfer Hei-VAP Value, Hei-VAP Value Digital, Hei-VAP Advantage

Betriebsanleitung vor Erstinbetriebnahme unbedingt lesen. Sicherheitshinweise beachten. Für künftige Verwendung aufbewahren.

About this Document	4
Version and variants	4
About this manual	4
Terms and signs used.....	5
Safety Instructions	6
General safety instructions / Consignes de sécurité générales.....	6
EU Declaration of Conformity / Déclaration de conformité UE	6
Intended use / Utilisation conforme.....	7
Installation, Electrical safety / Installation, sécurité électrique	7
Personnel qualification / Qualification du personnel.....	8
Operating company's obligations / Obligations de la société exploitante	8
Installation site / Lieu de montage	8
Changes to the unit	9
Safety for the personnel / Sécurité du personnel.....	9
Safety during use / Sécurité durant l'utilisation.....	10
Disposal / Mise au rebut	11
Device Description	12
Device overview	12
Hei-VAP Value, Hei-VAP Advantage: Overall view.....	12
Hei-VAP Value: Control panel.....	12
Hei-VAP Value Digital: Control panel.....	13
Hei-VAP Advantage: Control panel	13
Start-Up	14
Connect/disconnect power cord	14
Switch unit on and off	14
Heating bath and lift	15
Fill heating bath	16
Connect heating bath	16
Empty heating bath	17
Menu navigation.....	18
Operation	19
Adjust flask rotation.....	19
Setting bath temperature	21
Determine vapor temperature	22
Set duration for process	23
Evaporating and receiving flask	24
Mount and remove evaporating flask	24
Mount and remove receiving flask	25
Dispensing sample.....	26
Ventilation	26

Cleaning and Maintenance	27
Cleaning.....	27
Maintenance	27
Troubleshooting	28
Malfunctions and resolution.....	28
Overheat protection: reset.....	30
Assembly	31
Electrical connections.....	31
Connexions Electriques.....	32
Mount device	33
Assembly parts.....	33
Transportation lock	34
Heating bath	35
Vapor tube.....	35
Condenser	37
Inlet tubes.....	42
Vapor temperature sensor, AUTOaccurate sensor.....	43
Evaporating flask angle and depth	43
Control panel	45
Connecting peripheral devices	46
Connect vacuum.....	46
Connect cooling water	48
Mount tubes.....	49
Additional accessories	49
Disassembly and Storage	50
Dismantling, transportation and storage	50
Dismantling	50
Transportation and storage	51
Accessories and Spare Parts	52
Scope of delivery.....	52
Accessories.....	52
Attachments	53
Technical data	53
Service	54
Contact / Technical Service	54
Warranty	55
Confirmation of condition of unit.....	56
Déclaration de non-opposition	57



> Version and variants

Version

This manual describes the function, operation and maintenance of the Hei-VAP Value, Hei-VAP Value Digital and Hei-VAP Advantage evaporators.

Version	Alteration date
1.2	12/2016

Variants

The units are available in different configurations. Certain features and functions apply to specific configurations only. The varieties are documented in this manual.

> About this manual

This operating manual is a component of the device described here.



- Please read this manual carefully and obey all safety and warning notices.
- Ensure that every operator reads this manual.
- Ensure that this manual is accessible for every operator.
- Pass on the operating manual to the subsequent owner.



For the current version of this operating manual in pdf format, please go to:



[http://www.heidolph.com/Support/Operation Manuals/Rotary Evaporators/Hei-VAP Series/Hei-VAP Value, Hei-VAP Value Digital and Hei-VAP Advantage.](http://www.heidolph.com/Support/Operation%20Manuals/Rotary%20Evaporators/Hei-VAP%20Series/Hei-VAP%20Value,%20Hei-VAP%20Value%20Digital%20and%20Hei-VAP%20Advantage)

In addition, please observe the regional regulations.

➤ Terms and signs used

In this manual you will find standardized terms and signs to warn you of possible dangers or give important hints. Please take special notice to these signs to avoid personal injury or damage to the appliance.

The following terms and type of signs (basic drawing elements) are used:

Symbol	Additional term / Description
Warning signs 	<p>The yellow triangle indicates hazardous situations. It is used in combination with the following terms:</p> <p>DANGER: Indicates a hazardous situation which, if not avoided, will result in irreversible injury or death.</p> <p>WARNING: Indicates a hazardous situation which, if not avoided, could result in serious injury or material damage.</p> <p>CAUTION: Indicates a hazardous situation which, if not avoided, may result in a minor injury or material damage.</p>
Pictogrammes d'avertissement 	<p>Le triangle jaune indique les situations dangereuses. Il est utilisé en association avec les termes suivants:</p> <p>DANGER : Indique une situation dangereuse qui, si elle n'est pas évitée, entraîne une blessure irréversible certaine ou la mort.</p> <p>AVERTISSEMENT: Indique une situation dangereuse qui, si elle n'est pas évitée, pourrait entraîner une blessure ou des dommages matériels graves.</p> <p>ATTENTION : Indique une situation dangereuse qui, si elle n'est pas évitée, peut entraîner une blessure ou des dommages matériels légers.</p>
Mandatory signs 	<p>Must do:</p> <p>The blue circle indicates important information. Please obey to avoid property damage.</p>
Other signs used	
Symbol	Description
→	Handling instruction, action required
✓	Result of action
▪ ▪ ▪	List of information
a. b. c.	List of variants



➤ General safety instructions / Consignes de sécurité générales

EU Declaration of Conformity / Déclaration de conformité UE



This device complies with the following EC-Directives*:

- 2006/42/EC Machinery Directive
- 2014/30/EU Electromagnetic Compatibility Directive

*Also see attachment „EU Declaration of Conformity“.



Cet appareil est conforme aux directives EU suivantes *:

- 2006/42/CE Directive sur les machines
- 2014/30/UE Directive sur les compatibilités électromagnétiques

*Voir les pièces attachées „Déclaration de Conformité CE“

The device has been constructed according to state-of-the-art technology and recognized safety regulations. However, risks may still arise during installation, operation and maintenance./

L'appareil a été construit selon les règles de l'art de la technologie et selon les règlements de sécurité reconnus. Toutefois, les risques peuvent encore se poser lors de l'installation, l'exploitation et la maintenance.

- Please ensure the operating manual is available at all times./
S'il vous plaît assurez-vous que le manuel d'utilisation soit disponible à tout moment.

The device may only be used under the following circumstances:/ L'évaporateur rotatif doit être utilisé uniquement :

- Only operate the device, if it is in full working order.
Dans des conditions techniques parfaites.
- Ensure all operators of the device possess the necessary safety and risk awareness./
Assurez-vous que l'utilisatrice / l'utilisateur possède les connaissances nécessaires quant à la sécurité et aux dangers.
- Operate the device according to the instructions stipulated in this manual only. /
Dans des conditions d'utilisation conformes aux instructions du manuel uniquement.
- If there is something you do not understand, or certain information is missing, ask your manager or contact the manufacturer. /
Demandez à votre responsable ou au fabricant si vous ne comprenez pas ou ne trouvez pas certaines informations.
- Do not do anything on the device without authorization./
Ne modifiez en rien l'appareil sans autorisation.
- Only use the device according to its intended use./
Lorsque les instructions de ce manuel d'utilisation sont respectées.



Intended use / Utilisation conforme

The device is intended for use by trained and authorized personnel only./
L'appareil ne doit être exploité que par du personnel dûment formé et autorisé.

The device is suitable for the following use:/ L'appareil est appropriée pour:	<ul style="list-style-type: none">▪ Distillation to separate substances/ Distillation, évaporation▪ Concentration / Concentration▪ Crystallization / Crystallisation▪ Powder drying / Séchage de poudre
Operation of the device is suitable in one of the following locations:/ L'opération de l'appareil est appropriée dans laboratoire de:	<ul style="list-style-type: none">▪ Chemistry / Chimie▪ Pharmacy / Pharmacie▪ Biology / Biologie▪ Environmental analytics / Analyse environment▪ Basic research / Recherche fondamentale▪ Any other research laboratory / autre recherche laboratoire

Improper use / Utilisation non autorisée

Any use which deviates from the device's intended use is considered to be improper. The manufacturer does not accept liability for any damages resulting from non-permitted uses. The risk is carried by the operator alone./
Toute utilisation ne correspondant pas à l'utilisation conforme de l'appareil est considérée comme une utilisation non autorisée. Le fabricant décline toute responsabilité quant aux éventuels dommages. L'utilisateur en assume l'entière responsabilité.

Installation, Electrical safety / Installation, sécurité électrique

- The device may only be connected when the mains voltage corresponds to the information on the rating plate of the unit./
Veuillez vérifier, avant le raccordement de l'appareil au secteur, que la tension du secteur correspond aux indications inscrites sur la plaque caractéristique.
- The mains connection must be accessible at all times./
Connecteur et prise doivent être accessibles à tout moment.
- Repairs may only be performed by a qualified electrician./
Les réparations de toute nature sont autorisées uniquement par un professionnel qualifié.
- Never operate the unit with a damaged power cord./
N'utilisez pas l'appareil avec un câble électrique endommagé.
- Always turn the unit OFF and disconnect mains power before performing any maintenance or service./
Éteignez toujours l'appareil et débranchez l'alimentation avant l'entretien ou la réparation.



Personnel qualification / Qualification du personnel

- The device may only be operated by qualified persons./
L'appareil doit être utilisé uniquement par le personnel qualifié.
- The device may only be operated by individuals who have been instructed in its proper use by qualified persons./
L'appareil doit être utilisé uniquement par les personnes spécialement formées par du personnel qualifié.
- The device may only be operated and maintained by persons who are of legal age./
L'appareil doit être utilisé et entretenu uniquement par des personnes majeures.
- Other personnel may only work with the unit under continuous supervision of an experienced qualified operator./
D'autres personnes peuvent utiliser l'appareil uniquement sous surveillance continue du personnel qualifié.
- This manual must be read and understood by all persons working with the device. The personnel must receive special safety instructions in order to guarantee responsible and safe work procedures in the laboratory./
Ce manuel d'utilisation doit être lu et compris par toutes les personnes qui travaillent près de l'appareil. Le personnel doit avoir reçu des consignes de sécurité particulières afin d'assurer la responsabilité et la sécurité des procédures de travail dans le laboratoire.

➤ Operating company's obligations / Obligations de la société exploitante

Installation site / Lieu de montage

- The device must be positioned in a suitable location./
L'appareil doit être installé dans un endroit approprié.
- The device must be installed sufficiently stable on a temperature resistant surface./
L'appareil doit être monté sur une surface suffisamment stable et résistante à de fortes températures.
- Do not install the device in the vicinity of highly inflammable or explosive substances./
Aucune substance inflammable ou explosive ne doit être entreposée à proximité de l'évaporateur.
- Installation and operation of the device is only permitted in facilities which are fitted with the appropriate laboratory equipment (e.g. with air extraction units)./
L'appareil peut être utilisé uniquement dans des lieux disposant de l'équipement de laboratoire approprié (par ex. des hottes d'aspiration).



Safety Instructions

- The device may only be operated in enclosed spaces and under the following environmental conditions:
L'appareil ne peut être utilisé que dans un espace clos et dans les conditions environnementales suivantes :

Ambient temperature / température d'environnement	5 - 31 °C at 80 % relative humidity/ 5 - 31 °C pour 80 % d'humidité relative de l'air
	32 - 40 °C decrease linearly till max. 50 % relative humidity/ 32 - 40 °C décroissant de façon linéaire jusqu'à max. 50% d'humidité relative de l'air
Installation altitude / Altitude d'installation	0 - 2,000 m (6,500 feet) height above sea level/ 0 - 2000m au-dessus du niveau de la mer
Degree of pollution / Degré de pollution	2
Overvoltage category / Catégorie de surtension	II

Depending on the medium used / Selon le type de support utilisé:

- Only operate the device in conjunction with an extractor hood (at least 10-fold air change, with error monitoring), see DIN EN 14175 and DIN 12924./
Assurez-vous que l'évaporateur rotatif est utilisé uniquement lorsqu'il est raccordé à une hotte d'aspiration, renouvellement de l'air x10, avec contrôle des erreurs (voir les normes DIN EN 14175 et DIN 12924).

Changes to the unit

- No unauthorized changes may be made to the unit.
- No parts may be used which have not been approved by the manufacturer.
- Unauthorized changes result in the EC Declaration of Conformity losing its validity, and the appliance may no longer be operated.
- The manufacturer is not liable for any damage, danger or injuries that result from unauthorized changes or from operating the unit other than as described in this manual.

Safety for the personnel / Sécurité du personnel

- Ensure that only qualified personnel operate the device./
Assurez-vous que l'appareil est utilisé uniquement par du personnel qualifié.
- Observe the following regulations: / Respectez les directives suivantes :
 - Laboratory guidelines / Directive concernant les laboratoires
 - Accident prevention regulation /
Règlementations relatives à la prévention des accidents
 - Ordinance on hazardous substances /
Ordonnance relative aux substances dangereuses
 - Other generally accepted rules of safety engineering and occupational health/
Diverses règlementations généralement reconnues, relatives à la sécurité et la médecine du travail
 - Local regulations / Dispositions locales



➤ Safety during use / Sécurité durant l'utilisation

- Wear the appropriate protective clothing when working on the device (protective glasses and, if necessary, safety gloves)./
Porter des vêtements de protection appropriés (lunettes de protection et gants de protection, le cas échéant) lors de l'utilisation de l'évaporateur rotatif.
- Do not use the device in potentially explosive areas. The device is not protected against explosion. There is no explosion or ATEX protection available./
Ne pas utiliser l'appareil dans des zones à risque d'explosion. L'appareil n'est pas protégé contre les explosions. Il ne possède pas de protection conforme aux normes Ex ou ATEX.
- Do not use distillation material where the distillation residue might be explosive./
Ne pas utiliser de matière à distiller dont les résidus de distillation peuvent être explosibles.
- Do not carry out work with naked flames in the vicinity of the device (risk of explosion)./
Ne produire aucune flamme nue près de l'évaporateur rotatif (danger d'explosion).
- Do not apply excess pressure on the device. /
Ne pas exercer de pression trop importante sur l'appareil.
- Do not exceed the flow rate of 1 m/s while sucking in liquids with flammable materials (electrostatic charge; risk of ignition)./
Ne pas dépasser un débit de 1 m/s lors de l'aspiration de liquides contenant des substances inflammables (charge électrostatique ; danger d'inflammation).
- Eliminate the production of gases classified in explosion group IIC during distillation by materials or due to chemical reactions, e.g. hydrogen./
Éliminer la formation de gaz du groupe d'explosion IIC lors de manipulation de matières et de réactions chimiques, par ex. l'hydrogène.
- Do not operate or assemble devices in the vicinity which are emission or radiation sources (electromagnetic waves) for the frequency range ($3 \cdot 10^{11}$ Hz to $3 \cdot 10^{15}$ Hz)./
Ne monter ni mettre en service aucun appareil qui représente une source d'émission ou de radiation (ondes électromagnétiques) pour la gamme de fréquence ($3 \cdot 10^{11}$ Hz à $3 \cdot 10^{15}$ Hz).
- Do not operate or assemble appliances in the vicinity of the device which constitute emission or radiation sources for ionizing radiation or in the ultrasonic range./
Ne monter ni mettre en service aucun appareil qui représente une source d'émission ou de radiation pour les ondes ionisantes ou dans le domaine des ultrasons.
- Do not operate the device where adiabatic compression or shock waves might occur (shock wave combustion)./
Ne pas mettre en service l'appareil alors qu'une compression adiabatique ou onde de choc ne peuvent être générées (inflammation d'ondes de pression).
- Do not use materials which pose a potential risk of uncontrolled energy release which might result in pressure increase (exothermic reaction; spontaneous combustion of dusts)./
Ne pas utiliser des matières impliquant un danger potentiel de libération d'énergie non maîtrisée, causant une augmentation de la pression (réaction exothermique ; combustion spontanée de poussières).
- Verify that the basic device is only plugged to or unplugged from the heating bath if the main switch is switched off and/or the main power supply is disconnected./
S'assurer que l'appareil de base n'est branché au bain chauffant ou débranché du bain chauffant que lorsque l'interrupteur est fermé et/ou que le raccordement de l'appareil est débranché.



Safety Instructions

- Only use suited heat transfer fluid./
Utiliser uniquement des fluides caloporteurs appropriés.
- Do not adjust the maximum excess pressure of the coolant to more than 2 bar in the condenser./
Ne pas ajuster la surpression maximale du fluide réfrigérant à plus de 2 bar dans le condensateur.
- Glassware may not be operated with pressure difference above 2 bar./
L'écart entre la pression interne et externe des objets en verre ne doit pas être supérieur à 2 bar.
- Connect all cables and tubes correctly and locate them outside the operating and danger zone./
Raccorder tous les câbles et conduites correctement et les placer hors de la zone d'exploitation et de danger.
- Avoid putting pressure on the display when you are not operating the device./
Éviter d'appuyer sur l'écran lorsque l'appareil n'est pas en marche.
- Eliminate errors immediately./
Les anomalies doivent être immédiatement résolues.
- Do not use abrasive material to clean the glass surface. Only wipe with damp cloth./
Utiliser uniquement des tissus humidifiés pour nettoyer les surfaces en verre et jamais un tissu abrasif.
- Always switch the mains off after use./
Toujours éteindre l'appareil après utilisation.

➤ Disposal / Mise au rebut

- Check the device components for hazardous substances and solvents./
Contrôler si les composants de l'appareil sont contaminés par des substances et des solvants dangereux.
- Clean all components before disposal./
Nettoyer tous les composants avant la mise au rebut.
- Dispose of the device according to the appropriate national legal regulations./
Éliminer l'appareil conformément aux dispositions légales en vigueur.
- Dispose of the packaging material in accordance with the appropriate national legal regulations./
Éliminer l'emballage conformément aux dispositions légales en vigueur.



➤ Device overview

Hei-VAP Value, Hei-VAP Advantage: Overall view



Hei-VAP Value: Control panel





Hei-VAP Value Digital: Control panel



Hei-VAP Advantage: Control panel





➤ Connect/disconnect power cord

Connect power cord

The power cord comes with a three-wire plug and a recess on the bottom side.



Unit plug

Power cord

The socket is located on the back side of the unit.

- Connect plug to the socket with the recess facing down.
- Push plug up against socket until securely attached.
- Connect plug to power socket.



Unit socket

Disconnect power cord

- Disconnect plug from power socket first.
- Then disconnect plug from socket on unit.

➤ Switch unit on and off

The ON/OFF switch is situated on the left side of the device beneath the control panel.

Switch unit on

- Press the ON/OFF switch on the left side.

Hei-VAP Value

- ✓ The operating indicator light switches on.

Hei-VAP Value Digital, Hei-VAP Advantage

- ✓ The display switches on and shows set parameters.
- ✓ The unit is switched on.



ON/OFF switch: ON

Switch unit off

- Press the ON/OFF switch on the left side.

Hei-VAP Value

- ✓ The operating indicator light switches off.

Hei-VAP Value Digital, Hei-VAP Advantage

- ✓ The display switches off.
- ✓ The unit powers off.



➤ Heating bath and lift

You can fill the heating bath with various heating bath fluids:

- Tap water (no deionized or distilled water)
- Water soluble polyethylene glycol
- Oil with low viscosity (40 cP) and flashpoint > 285°C.



Danger/ Danger Risk of explosion! / Danger d'explosion !

Heating bath fluid oil with a flashpoint < 285 °C might ignite and lead to uncontrollable thermic reactions and explosion./

Chauffer avec un bain chauffant de l'huile ou un liquide avec un point d'inflammation < 285 °C est dangereux car il pourrait s'enflammer avec des températures élevées et conduire à des réactions thermiques incontrôlables et à des explosions.

- ➔ Only use > 285 °C flashpoint oils./
N'utiliser que des huiles avec un point éclair > 285°C.

The marks inside heating the bath show the minimum and maximum level for heating bath fluid with evaporating flask completely immersed.

Evaporating flask is immersed by moving up and down via the heating bath lift.



When heating bath lift is moved downwards the evaporating flask displaces already filled in fluid.

To prevent heating bath from overflow:

- Move down the lift with evaporating flask mounted before filling bath.
- Fill in heating bath fluid till the maximum level mark is reached.



Do not let the evaporating flask touch the bottom or the edge of the heating bath.

(To adjust the evaporating flask depth and flask angle please view chapter "Assembly", section "Evaporating flask: Adjust Evaporating flask angle and depth".)



Start-Up



Immerse Flask: Hand lift

- Push down hand lift lever.
- Move pushed hand lift lever to the left to lower or to the right to raise lift.
- Release hand lift at the desired position.
- ✓ The hand lift locks into place.



Hand lift lever: upper lift position

Immerse Flask: Motor lift

- ✓ Unit is switched on.
- Push lift key down  or up  to move motor lift.
- Release lift key at desired position.
- ✓ The motor lift stops.



Lift keys: up, down

Fill heating bath

- ✓ Evaporating flask is immersed.
- Fill in heating bath fluid till maximum level mark is reached.
- ✓ The level of fluid is between the minimum and the maximum mark.

Connect heating bath



Warning:

Risk of crushing! Risk of scalding!

When unit is switched on, rotation or heating can be started accidentally and result in severe injuries.

Only connect heating bath to base unit when the unit is switched off.



Avertissement :

Danger d'écrasement ! Risque de brûlures !

Quand l'unité est allumée, la rotation ou le chauffage peut s'enclencher accidentellement et entraîner des blessures graves.

Connecter le bain chauffant à l'unité de base uniquement lorsque l'unité est éteinte.





Start-Up

The heating bath plug is located on the right side in the back of the heating bath.

- ✓ Unit is switched off.
- ✓ Heating bath is locked into place at the base of the unit.



- Connect 7-pole socket to plug of the heating bath with the recess facing up.
- Fix with knurled nut turning it clockwise.

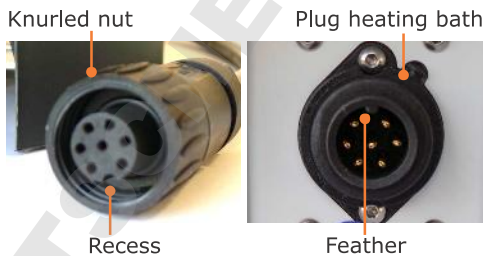

Empty heating bath



Warning:
Risk of scalding! Risk of slipping!

When emptying the heating bath, you may burn yourself or slip on spilled fluid.

Before emptying heating bath:

- Remove evaporating flask.
- Disconnect base unit and heating bath.
- Wait until the heating bath fluid cools down to $<50^{\circ}\text{C}$.
- Please wear protective clothes.



Avertissement :
Risque de brûlures ! Risque de glissade !

Lors de la vidange du bain chauffant, vous risquez de vous brûler ou de glisser sur du liquide répandu.

Avant de vider le bain chauffant :

- Retirer le ballon d'évaporation.
- Déconnecter l'unité de base et le bain chauffant.
- Attendre que le liquide du bain chauffant refroidisse à $<50^{\circ}\text{C}$.
- Porter des vêtements de protection.

- ✓ Evaporating flask is removed.
- Turn knurled nut counter clockwise to unlock it.
- Remove socket from heating bath.
- Empty heating bath.
- Lift bath carefully at both handles and empty.



➤ Menu navigation

Control panel Hei-VAP Value Digital

Start screen shows the last set and the actual temperature.

- ✓ Both rotary knobs are turned left as far as they will go.
- ✓ The unit is switched on.
- ✓ The display shows set and actual temperature.
- ➔ Turn rotation knob or temperature knob clockwise.
- ✓ When adjusting temperature the display shows the setting.
- ➔ Press ON/OFF key above knob.
- ✓ ON/OFF key lights up and set process starts.
- ➔ Press ON/OFF key again.
- ✓ Light of ON/OFF key switches off.
- ✓ The process is discontinued.



Control panel Hei-VAP Advantage

The start screen shows the actual values. Adjust parameters temperature and rotation with select knob Hei-GUIDE.

- ➔ Turn select knob Hei-GUIDE clockwise slowly to the right.
- ✓ Selected parameter is framed.
- ✓ The frame jumps to next parameter when turning select knob.
- ➔ Press select knob Hei-GUIDE.
- ✓ The addressed parameter field is shown.
- ➔ Turn select knob Hei-GUIDE to adjust parameter.
- ➔ Press select knob to confirm setting.
- ➔ Turn select knob Hei-GUIDE to select and adjust next parameter.
- ➔ Start heating and rotation by pushing appropriate ON/OFF key.
- ✓ When heating is switched on the heating key lights up.
- ✓ A preset timer starts as soon as rotation is started.





➤ Adjust flask rotation

By increasing flask rotation you can increase your evaporation rate. A shorter evaporation time may prevent thermal damage to your sample.

Depending on flask size and heating bath temperature different rotation speeds may be suitable.

Speed range and setting

Rotation speed can be set from 10 rpm - 280 rpm.



Warning: **Risk of scalding and slipping!**

At high flask rotation speeds bath fluid may splash or spill over and result in a slippery floor and/or severe scalding.

If you are operating the unit without a safety hood:

- Run a test with your heating bath fluid temperature and rotation speed and document any size of splashing.
- Ensure that this documentation is communicated and accessible to all individuals.
- Wear safety clothes if you are working in near proximity to the unit.
- Pay attention to any amount of heating bath fluid on the floor.



Avertissement : **Risque de brûlures et de glissade !**

La vitesse de rotation rapide du ballon peut provoquer des éclaboussures ou des débordements rendant le sol glissant et/ou entraînant des brûlures graves.

En cas d'exploitation de l'unité sans capot de protection :

- Pratiquer un test avec la température et la vitesse de rotation du bain chauffant et noter le volume des éclaboussures.
- S'assurer que ces notes sont communiquées et mises à disposition de tous les individus.
- Porter des vêtements de protection lors du travail à proximité de l'unité.
- Faire attention à toute quantité de liquide de bain chauffant répandu sur le sol.

→ Test your selected fluid

- with slowly increasing temperatures
- with different evaporating flasks
- with increasing rotation speeds

→ Note these results and make them accessible for all contributors.



Depending on the oil and age of oil you are utilizing the heating bath temperature may change the viscosity and the volume of the bath fluid.

Keep records of the exact description/manufacturer information and period of use and repeat the documentation in the determined time interval.



Operation

Hei-VAP Value



- ✓ Rotation knob is turned to the left as far as it will go.
- ✓ Unit is switched on.
- ✓ Evaporating flask is immersed into the heating bath.
- Press rotation key .
- Enter desired rpm with rotation knob.
- Press rotation key to stop the rotation.

Rotation key



Rotation knob

Hei-VAP Advantage

- ✓ Unit is switched on.
- Select „rotation“ field with select knob Hei-GUIDE.
- Enter desired rpm and confirm.
- Press rotation key  to start rotation.
- Adjust speed via field „rotation“.
- ✓ Actual rpm is shown in the field „rotation“.
- ✓ Time of your process is shown under „timer“ in minutes. An up arrow is displayed next to the time.
- Press rotation key  to stop rotation.

„rotation“ field



Select knob Hei-GUIDE

Rotation key



› Setting bath temperature

Possible temperature range:

- Water bath application 20°C - 100°C
- Oil bath application 20°C - 210°C



With a pre-set temperature above 75 °C to 80 °C we recommend oil or polyethylen glycol as heating bath fluid.

Set "Oil" as medium if you work with polyethylen glycol. Please follow temperature specification provided by manufacturer.



Danger / Danger Risk of explosion! / Danger d'explosion !

Potential loss of life/ Danger de mort

- Only use > 285°C flashpoint oils./
N'utiliser que des huiles avec un point éclair >285°C.



Warning / Avertissement: Risk of scalding! / Risque de brûlures !

If you operate your unit without a safety hood and at high heating bath temperatures there is a risk of scalding./

En cas d'exploitation de l'unité sans capot de protection et à des températures de chauffage élevées, il existe un risque de brûlures.

Please wear safety clothes (lab coat, gloves, safety glasses) every time you are in near proximity to the unit during operation./

Portez des vêtements de protection (blouse de laboratoire, gants, lunettes de protection) à chaque fois que vous vous trouvez à proximité de l'unité lors de son exploitation.



Caution / Attention: Potential damage of unit / Dommages potentiels sur l'unité

The heating starts quickly and if empty, the heating bath can be stained./



La chaleur augmente rapidement et si le bain chauffant est vide, il peut être taché.

Switch on heating only when heating bath is filled sufficiently with fluid./

Allumer le chauffage uniquement lorsque le bain chauffant est suffisamment rempli de liquide.



Adjust heating bath temperature: Hei-VAP Value, Hei-VAP Digital

- ✓ Unit is switched on.
- ✓ Heating bath is filled with water or oil.
- ✓ Evaporating flask is immersed into heating bath.
- Set temperature with temperature knob.
- Press heating key  to start heating.
- ✓ The heating key is illuminated as long as the heating function is on.
- ✓ Control light „heating“ is lit as long as unit heats up and set temperature has not been reached yet.
- Press heating key  to stop heating.

Set heating bath fluid (Hei-VAP Advantage only)



- ✓ Unit is switched on.
- ✓ The frame blinks over previously selected medium „oil“ or „H₂O“.
- Select your heating bath fluid within 10 seconds.
- ✓ The frame jumps to the field „temperature“.



After 10 seconds of inactivity, the frame over heating bath fluid disappears.

If you still need to select the heating bath fluid, switch unit off and on again.

Adjust heating bath temperature: Hei-VAP Advantage

- ✓ „bath temp“ is selected.
- Enter desired temperature and confirm.
- Press heating key  to start heating.
- ✓ Heating key is illuminated as long as heating function is on.
- ✓ Actual temperature is shown under „bath temp“.
- Adjust temperature via „bath temp“ field.
- Press heating key  to stop heating.



With heating bath fluid water temperatures above 100°C are not permitted due to safety reasons. Please use oil as heating bath fluid if you adjust temperatures above 100°C.

➤ Determine vapor temperature

(Hei-VAP Advantage only)

- ✓ A vapor temperature sensor is inserted to the condenser and connected with the temperature sensor socket (see chapter „Assembly, Mount device“, section „Vapor temperature sensor“).
- Switch on unit.
- ✓ Actual vapor temperature is shown under „vapor temp“ in the display.



➤ Set duration for process

(Hei-VAP Advantage only)

Duration of process can be set with the function „timer“.

Adjustable process time: 0 min. – 999 min.

- ✓ Unit is switched on.
- ✓ Speed and temperature are set.
- Enter process time in “timer” field and confirm.
- Start heating and rotation.
- ✓ As soon as rotation is started, the timer clock starts to run in reverse.
- ✓ A down arrow is shown under „min“.
- ✓ After end of process time:
 - heating bath turns off
 - frame around time blinks „000“

Variant hand lift

- rotation is reduced to 20 rpm

Variant motor lift

- rotation switches off
- lift drives up



Arrow pointing down: timer active



➤ Evaporating and receiving flask



Warning: **Risk of injury!**

If unit is switched on during assembly of evaporating flask, rotation can be started accidentally and might lead to injuries.

Mount and remove evaporating flask only while unit is switched off.



Warning: **Risk of glass breakage!**

If a flask is damaged, glass can break causing serious injuries.

Work with undamaged glass only and check all glassware regularly for any damage.



Avertissement : **Risque de blessure !**

Si l'unité est allumée pendant l'assemblage du ballon d'évaporation, la rotation peut s'enclencher accidentellement et entraîner des blessures.

Monter et retirer le ballon d'évaporation uniquement lorsque l'unité est éteinte.



Avertissement : **Risque de bris de verre !**

Si un ballon est endommagé, cela peut entraîner un bris de verre supplémentaire et causer des blessures graves.

Travailler uniquement avec du verre sans défaut et vérifier que toutes les pièces en verre sont exemptes de dommages.

Mount and remove evaporating flask

Mount evaporating flask

- Insert evaporating flask with Easy-Clip open over the vapor tube.
- Tilt Easy-Clip over flange of evaporating flask.
- ✓ Easy-Clip is clicked into place.
- ✓ Evaporating flask is safely assembled.



Easy-Clip open



Easy-Clip closed

Remove evaporating flask

Removing the evaporating flask:

- Heating must be switched off.
- Rotation must be at „0“.
- Vacuum pump must be switched off.
- Lift with the evaporating flask must be in top position (see chapter "Start-Up, Heating bath and lift").
- Unit must be switched off.



Danger:
Risk of scalding!

If the evaporating flask has not cooled down it may cause severe scalding.

- Ensure that the evaporating flask has cooled down prior to exchanging it.
- The evaporating flask should not show a temperature above 50 °C or 122 °F.
- Wear protective clothing.
- Wear appropriate gloves to ensure a safe grip.



Danger :
Risque de brûlures !

Si le ballon d'évaporation n'a pas refroidi, il peut entraîner des brûlures graves.

- S'assurer que le ballon d'évaporation a refroidi avant de le changer.
- Le ballon d'évaporation ne devrait pas afficher une température supérieure à 50 °C ou 122 °F.
- Porter des vêtements de protection.
- Porter des gants appropriés afin d'assurer une prise sûre.

- With 1-2 turns counter clockwise unscrew coupling of the flask clamp Easy-Clip.
- Hold evaporating flask with one hand and open the Easy-Clip.
- Remove evaporating flask carefully.

Mount and remove receiving flask

Mount receiving flask

- Hold receiving flask with open end onto the flange of the condenser.
- Slide clamp over flange of condenser and receiving flask.
- Tighten knurled screw of clamp carefully.
- The receiving flask is mounted.

Remove receiving flask

- Hold receiving flask with one hand.
- Loosen knurled screw of clamp.
- Remove clamp from flange.



Knurled screw

Clamp



➤ Dispensing sample

Regulate refill of sample during a process through the inlet tube.

- ✓ Glassware is under vacuum.
- Turn inlet valve counter clockwise.
- ✓ Inlet valve is open and sample is drawn into evaporating flask.
- ✓ The further you open the inlet valve, the faster the sample will be drawn in.
- Turn inlet valve clockwise.

Refill of sample will be reduced respectively stopped.

Inlet valve



Ventilation cap

➤ Ventilation

The system can be ventilated with the ventilation cap manually.

- To ventilate turn ventilation cap slowly counter clockwise.
- ✓ System is ventilated.
- Turn ventilation cap slowly clockwise.
- ✓ Air inlet is closed gradually.



> Cleaning

The housing parts and all surfaces of the unit allow for cleaning with a damp cloth and if required a mild soap lotion.



Caution:
Damage to the surfaces

All surfaces can be damaged by improper cleaning.

Never use:

- Chlorine bleach or any cleaning agent including chlorine
- Ammonia
- Abrasive cleaning agents such as cleaning rags, scrubbing agents or any other agents which include metal components



Attention :
Dommages sur les surfaces

Toutes les surfaces peuvent être endommagées par un nettoyage inapproprié.

Ne jamais utiliser :

- Un agent de blanchiment au chlore ou tout agent nettoyant contenant du chlore
- D'ammoniaque
- D'agents nettoyants abrasifs comme des torchons, des agents de lavage ou tout autre agent contenant des composants métalliques

Cleaning instructions for heating bath

Over a shorter or longer period of time rust and deposition of solids may be observed.



Rust can be removed easily with stainless steel polish.

Lime deposits can be removed with standard cleaning agents based on acetic or citric acid.

Please follow the manufacturer's instructions in both cases.

> Maintenance



Caution:
Damage to your system

Never continue working with a damaged or a worn-off PTFE seal. Otherwise the unit can be damaged accordingly.

Seals must be checked on a regular basis and must eventually be replaced.



Attention :
Dommages sur votre système

Ne jamais continuer à travailler avec un joint en PTFE endommagé ou abîmé. Si c'est le cas, l'unité peut être endommagée en conséquence.

Les joints doivent être vérifiés régulièrement et remplacés si besoin.

The unit is maintenance-free. Any necessary repair must be performed by an authorized Heidolph distributor.

Please contact Heidolph Instruments or your local Heidolph Instruments distributor.

Troubleshooting

Malfunctions and resolution

General Malfunctions	Possible reason	Troubleshooting
<ul style="list-style-type: none"> Unit cannot be switched on. Display doesn't switch on. 	No power supply	<ul style="list-style-type: none"> Check size and shape of plug and compatibility to your electrical socket Check circuit breakers
	Fuse defective	Replace device fuse (see chapter "Assembly, Electrical Connections")
	ON/OFF-switch off	Switch on ON/OFF-switch
	ON/OFF-switch defective	Please contact your local Heidolph Instruments distributor
No heating function	Connecting cable heating bath not connected	Connect cable
	Heater defective	Please contact your local Heidolph Instruments distributor
	Overheat protection on	<ul style="list-style-type: none"> Heating bath is filled: Cool down heating bath, reset overheat protection (see next section) Heating bath is empty: Contact your local Heidolph Instruments distributor
No rotation function	Speed controller turned left as far as it will go (Hei-VAP Value, Hei-VAP Value Digital)	Adjust speed
	Drive defective	Please contact your local Heidolph Instruments distributor
Lift not working	Lift is at end of stop	Move lift in opposite direction
	Lift is at height stop	Change height stop
	Mechanic / Motor defective	Please contact your local Heidolph Instruments distributor
No vacuum	Vacuum pump switched off	Switch vacuum pump on
	Vacuum valve defective	Replace vacuum valve
Insufficient vacuum	Leakage in system	<ul style="list-style-type: none"> Check seals and connections Check joints and grease if necessary
	Vacuum pump defective	Refer to manufacturers instructions
No display of vapor temperature	Vapor temperature sensor not connected	Connect vapor temperature sensor
Device switches off (Hei-VAP Advantage)	Process time activated	Check and turn off timer if necessary

Troubleshooting

Hei-VAP Value Digital Error message (blinking code)	Possible reason	Troubleshooting
**	Cable connection between controller and base unit disconnected	Connect cable
	Failure in database	Please contact your local Heidolph Instruments distributor
***	<ul style="list-style-type: none"> ▪ Heating defective ▪ Overheat protection on 	<ul style="list-style-type: none"> ▪ Heating bath is filled: Cool down heating bath, reset overheat protection (see next section) ▪ Heating bath is empty: Contact your local Heidolph Instruments distributor
	Safety temperature exceeded by +5°C	Please contact your local Heidolph Instruments distributor
	Heating bath fluid vaporized	<ul style="list-style-type: none"> ▪ Switch off unit ▪ No heating: reset overheat protection (see next section) ▪ Refill heating bath fluid
	Heating bath sensor difference > 10°C	Please contact your local Heidolph Instruments distributor
	<ul style="list-style-type: none"> ▪ Temperature sensor heating bath defective ▪ Temperature of heating bath fluid > 217 °C ▪ Temperature of heating bath fluid < 0 °C 	Please contact your local Heidolph Instruments distributor
****	<ul style="list-style-type: none"> ▪ Potentiometer temperature defective ▪ Potentiometer speed defective 	Please contact your local Heidolph Instruments distributor
*****	Motor overloaded	<ul style="list-style-type: none"> ▪ Switch off unit ▪ Contact your local Heidolph Instruments distributor
Display shows --- instead of vapor temperature	Vapor temperature sensor defective	Replace vapor temperature sensor

Troubleshooting

Hei-VAP Advantage: Error message	Possible reason	Troubleshooting
1	<p>Motor lift only: Transportation lock activated</p> <p>Cable connection between controller and base unit disconnected</p>	<ul style="list-style-type: none"> ▪ Remove transportation lock ▪ Move lift upwards ▪ Switch unit off and on <hr/> <ul style="list-style-type: none"> ▪ Connect cable ▪ Switch unit off and on
3	<ul style="list-style-type: none"> ▪ Heating defective ▪ Overheat protection on <hr/> <p>Safety temperature exceeded by +5°C</p> <hr/> <p>Heating bath fluid vaporized</p> <hr/> <p>Heating bath sensor difference > 10°C</p> <ul style="list-style-type: none"> ▪ Temperature sensor heating bath defective ▪ Temperature of heating bath fluid > 217 °C ▪ Temperature of heating bath fluid < 0 °C 	<ul style="list-style-type: none"> ▪ Heating bath is filled: Cool down heating bath, reset overheat protection (see next section) ▪ Heating bath is empty: Contact your local Heidolph Instruments distributor <hr/> <p>Please contact your local Heidolph Instruments distributor</p> <hr/> <ul style="list-style-type: none"> ▪ Switch off unit ▪ No heating: reset overheat temperature (see next section) ▪ Refill heating bath fluid <hr/> <p>Please contact your local Heidolph Instruments distributor</p> <hr/> <p>Please contact your local Heidolph Instruments distributor</p>
5	Motor overloaded	<ul style="list-style-type: none"> ▪ Switch off unit ▪ Contact your local Heidolph Instruments distributor
Display shows --- instead of vapor temperature	Vapor temperature sensor defective	Replace vapor temperature sensor

Overheat protection: reset

- Switch unit off. Remove cooled down evaporating flask.
- Disconnect heating bath plug and remove heating bath.
- If necessary empty heating bath and turn it upside down.
- Push the red knob on the bottom of the heating bath with a pointed object.
- ✓ Thermal cut-out is reset.



Reset overheat protection

If you experience a malfunction which can not be resolved, please contact your authorized Heidolph distributor immediately.



Electrical connections

- Fuses must **only** be replaced by a **professional electrician**.
- **Repairs** of any kind are allowed by **qualified professional electricians only**. Any improper repair can result in a dangerous situation. Contact your local Heidolph Instruments distributor for any repair you may have.



Warning: Electric shock!

This unit must only be connected to a grounded electrical socket.

The unit and voltage must match. The rating plate on the back side of the unit provides all voltage specifics (see picture below).

When shipped, the unit is grounded. In case the original plug is changed, the new plug must have a protective conductor!

If the device is still connected to power while changing the fuse, you might get in contact with live parts.

Prior to replacing the fuse ensure that the unit is switched off and pull the plug from the electric socket. Only use original fuses from Heidolph.

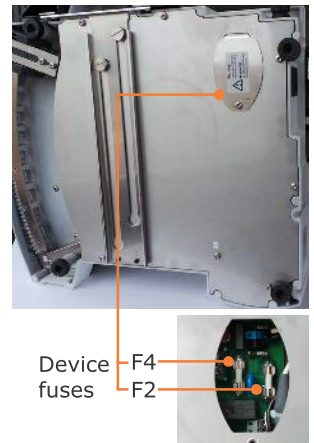
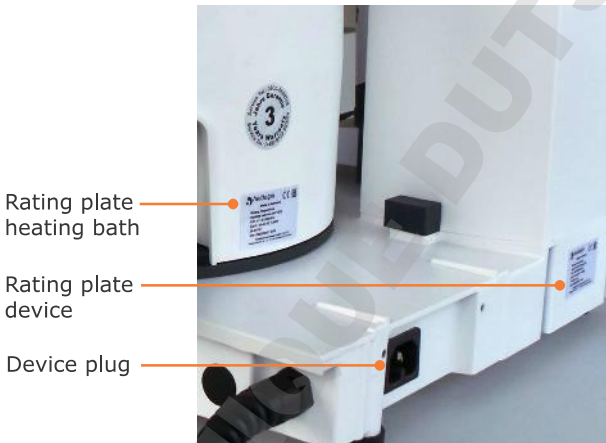

Color code for electrical connections:

Europe	
GREEN/YELLOW	PE: Protective conductor (Earth)
BLUE	N: Neutral conductor
BROWN	P: Phase

North America	
GREEN	PE: Protective conductor (Earth)
WHITE	N: Neutral conductor
BLACK	P: Phase

The unit is connected with the power cord supplied to the electrical socket. It plugs into the housing on the rear side of the unit.

For countries utilizing a plug other than the standard one supplied:

- The plug supplied may only be changed by a professional electrician.
- If utilizing an adaptor ensure that it is approved by the local regulations.



Connexions Electriques

- Les fusibles ne peuvent être remplacés que par **un Electricien professionnel**.
- Les **réparations** de toute nature sont autorisées **uniquement par un Electricien professionnel**. Une réparation incorrecte peut entrainer une situation dangereuse, contactez votre distributeur Heidolph pour toute réparation.



Avertissement: Choc Electrique !

Cet appareil doit être connecté à une prise électrique mise à la terre.

Voltage et intensité de cette prise. Derrière l'instrument, il y a une étiquette avec les requis obligatoires (voir image plus bas).

Avant tout envoi, l'appareil est mis à la terre. Si le connecteur original est changé, alors le nouveau devra obligatoirement avoir une connexion à la terre!

Si l'appareil est toujours connecté à l'alimentation, Il y a DANGER.

Pour changer un fusible, l'appareil doit-êtré éteint et celui-ci ne doit plus être relié au réseau électrique, donc enlever le cordon d'alimentation. N'utilisez que des fusibles provenant de chez Heidolph.

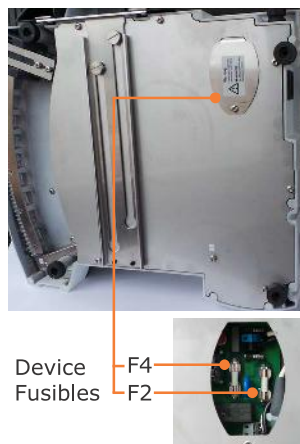

Connexion électrique, code couleur:

Europe

VERT/JAUNE	PE: fil de protection (Terre)
BLEU	N: Conducteur Neutre
MARRON	P: Phase

North Amerika

VERT	PE: fil de protection (Terre)
BLANC	N: Conducteur Neutre
NOIR	P: Phase

L'instrument doit être connecté avec le cordon secteur fournit. Il faudra insérer celui-ci à l'arrière de l'appareil dans le connecteur prévu à cet effet.

Pour les pays utilisant un autre système de branchement que le connecteur standard fournit:

- Le connecteur changé devra être effectué par un électricien professionnel.
- Si vous utilisez un adaptateur, celui-ci devra être conforme aux normes locales.



➤ Mount device

Assembly parts

Base unit



Heating bath

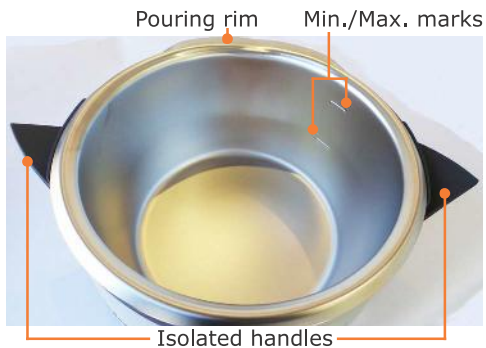

Control panel





Warning / Avertissement :
Risk of crushing! Risk of scalding! / Danger d'écrasement !
Risque de brûlures !

When unit is switched on, rotation or heating can be started accidentally and result in severe injuries./
 Quand l'unité est allumée, la rotation ou le chauffage peut s'enclencher accidentellement et entraîner des blessures graves.

Only assemble device when the unit is switched off. /
 Connecter l'unité uniquement lorsque l'unité est éteinte.

Transportation lock

(Motor lift only)

Transportation lock must be removed before you start. Keep the transportation lock for possible return shipments.

The transportation lock consists of three M5x8 screws and a connection plate with drilled holes to fix the position.

- ✓ Base unit is placed on a stable surface.
- Press and hold lift contact on the lift.



Lift contact

Transportation lock

- Loosen the three screws with allen key supplied and remove plate.
- Release lift contact.
- ✓ Lift drives up automatically.
- Keep all individual parts for subsequent use.



Transportation lock



Heating bath

Attach heating bath

- ✓ A movable base plate with an enhanced guide rail is located on the right side of the base unit.
- Place heating bath with gap on the guide rail.
- Move heating bath carefully to the left and right to lock it.



Move heating bath

It may be necessary to increase the distance between heating bath and drive when bigger evaporating flasks or spacers between evaporating flask and vapor tube are used.

- ✓ Base unit is placed on a stable surface.
- Allow sufficient space to move heating bath.
- ✓ On the right side the heating bath slides out approximately 20 cm to allow for adjustment.
- Hold heating bath on both handles and slide it to the right until you have reached the desired position.

Vapor tube

Assembly parts

- Vapor tube
- Flask clamp Easy-Clip
- Coupling vapor tube
- Clamping sleeve

The flask clamp Easy-Clip is pre-assembled in NS 29. For smaller flasks the Easy-Clip NS 24 is enclosed.

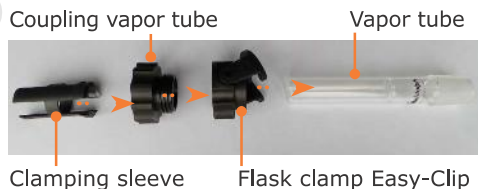

The device is delivered with pre-assembled coupling for the vapor tube and the condenser.

- Hold the locking knob beneath "lock" for a quarter turn.
- Unscrew coupling of the vapor tube along with the vapor tube on the right side of the drive.
- Unscrew coupling of the condenser on the left side of the drive.

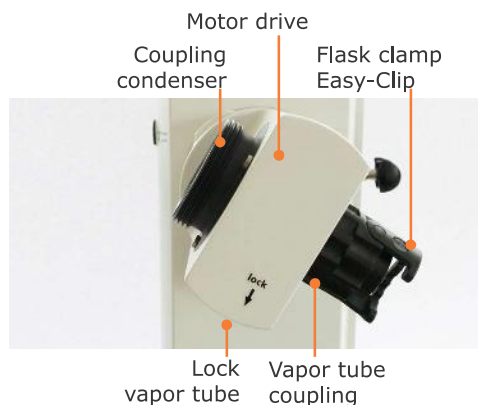



Assembly

- Remove tension spring and PTFE seal on the condenser side.



Caution:
Possible contamination, leakage, damage to your unit

Due to a damaged PTFE seal your SET vacuum may not be reached, your sample may be contaminated, your unit may be damaged.

Especially the sealing lip of the vacuum seal is susceptible to damage in handling. Never operate your system with a damaged or worn-off PTFE seal! Always check the condition of your PTFE seal regularly and if required replace it.



Attention :
Possibilité de contamination, de fuite et de dommage sur l'unité

À cause d'un joint en PTFE endommagé, le niveau de vide PROGRAMMÉ peut ne pas être atteint, l'échantillon peut être contaminé et l'unité endommagée.

La lèvre d'étanchéité en particulier est susceptible d'être endommagée lors de la manipulation. Ne jamais exploiter le système avec un joint en PTFE endommagé ou abimé ! Toujours vérifier l'état du joint en PTFE régulièrement et le remplacer si besoin.

- ✓ Coupling and Easy-Clip are screwed together.
- Push coupling of the vapor tube along with Easy-Clip on the vapor tube (direction and order as shown under "Assembly parts").
- Push clamping sleeve with the bead to the glass on vapor tube until it audibly locks.
- Insert vapor tube with clamping sleeve first from below to the drive and screw it tight.
- At the very last quarter turn, press locking knob.
- ✓ Coupling locks in and vapor tube is securely mounted.



Vapor tube, clamping sleeve and coupling



Condenser



Warning:
Risk of glass breakage!

If a flask is damaged, glass can break causing serious harm.
Work with undamaged glass only and check all glassware regularly for any damage.



Avertissement :
Risque de bris de verre !

Si un ballon est endommagé, cela peut entraîner un bris de verre supplémentaire et causer des blessures graves.
Travailler uniquement avec du verre sans défaut et vérifier régulièrement que toutes les pièces en verre sont exemptes de dommages.

PTFE seal

- Slide PTFE seal with the labeling "Motor Side" facing drive onto the vapor tube.
- ✓ The PTFE seal is tightened as far as it will go.



PTFE seal

Condenser: Glassware set G1 and G3

- Push coupling of glassware over condenser flange.
- Push tension ring over condenser flange.
- Screw condenser to the drive hand-tight.



Tension ring Coupling

- ✓ Condenser is mounted to the drive.





Condenser:

Glassware set G5 dry ice

- ✓ Condenser is mounted to the drive.
- Screw inlet tube with inlet valve onto opening opposite of vapor tube (see chapter "Assembly, Inlet tubes").
- If using inert gas screw inlet tube with inert gas valve onto opening above inlet valve.

Inert gas valve



Inlet valve

- Place red seal ring into notch at top of condenser flange.
- Place white PTFE ring with collar up on to condenser flange.
- Insert the jacket trap into condenser.
- ✓ Due to vacuum inside condenser, the flange is drawn in and the system is tight.
- To protect the dry ice, place black cap on top.





Assembly

Condenser: Glassware set G6 (Condenser for reflux distillation)

Additional assembly parts on the vapor tube:

- PTFE seal ring
- Spacer sleeve
- Additional coupling

✓ Vapor tube together with PTFE seal is mounted.

→ Insert PTFE seal ring into spacer sleeve.

→ Place spacer sleeve including PTFE seal ring with the narrow side facing to vapor tube on condenser side.

→ Screw on additional coupling with external thread pointing left.

→ Tighten distributor with coupling including tension spring on external thread.

→ Insert condenser to the upper joint of distributor.

→ Screw inlet tube with inlet valve onto opening opposite vapor tube (see chapter "Assembly, Inlet tubes").



Distributor



Distributor



Inlet tube



Assembly

- ✓ Distributor is mounted.
- Turn reflux valve clockwise until O-ring is clearly visible and white plug blocks output to receiving flask.
- ✓ Valve is closed and sample flows back to evaporating flask.
- Turn reflux valve counter clockwise until white plug unblocks the output of receiving flask.
- ✓ Valve is open and sample flows into receiving flask.

(For inlet valve and inlet tube see chapter "Assembly, Inlet tubes".)

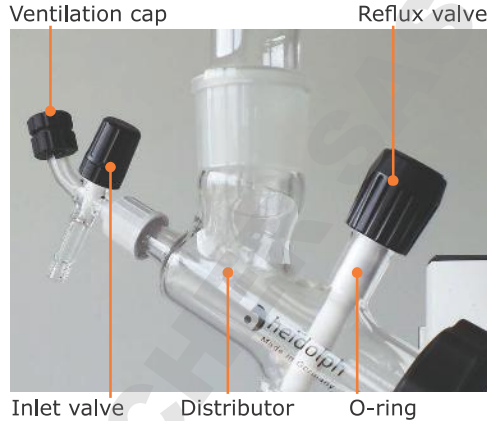

The system is not vacuum-tight if valve is opened too far. Open valve only in a way that the white seal ring beneath knurled screw remains visible 0.5 cm wide.



Assembly

Condenser support for vertical condenser: Glassware set G3 and G6

Assembly parts:

- Support rod
- Boss head with condenser clamp
- Allen key

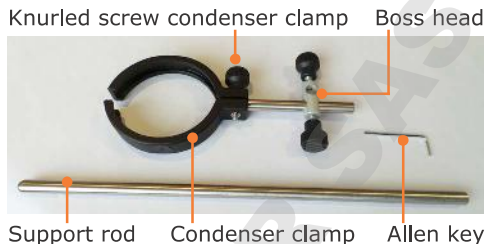

On the left side of the unit a drilling hole is placed to fix the support rod.

- Insert support rod with the flattened side downwards into hole.
- Secure support rod with allen screw using supplied allen key.

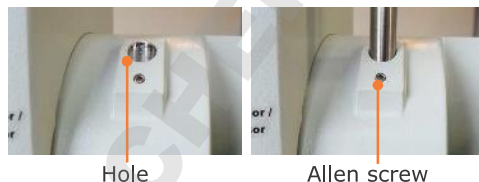

- Slide boss head of cross pole over support rod.
- Fix cross pole with knurled screw at support rod.
- Fix the condenser clamp with knurled screw around the condenser.

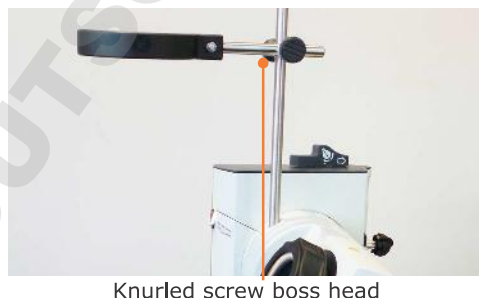

Knurled screw boss head

Condenser support for vertical condenser: Glassware set G5

Assembly parts:

- Support rod
- Boss head with tension band
- Allen key
- Mount condenser support analog to condenser support for G3 and G6.
- Fix condenser with the tension band.

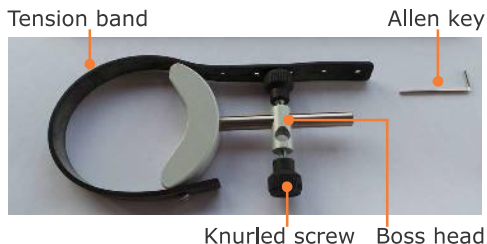



Inlet tubes

Assembly parts:

- 2x Inlet tube
- 1x Inlet valve

On the bottom left side of the condenser a ground opening is located to include stopcock with inlet tube.

Inlet tube 1

- Shorten supplied PTFE tube so that the end of the tube leads to the evaporating flask and attach it to the stopcock.
- Slide drain disk onto PTFE tube so that it is placed below the vapor opening of condenser.
- ✓ Condensed fluid cannot flow back into evaporating flask through inlet tube.
- Unscrew screw cap from condenser.
- Slide seal ring and screw cap approx. 3 cm onto PTFE tube.
- Insert PTFE tube with seal ahead into inlet opening and tighten screw cap.

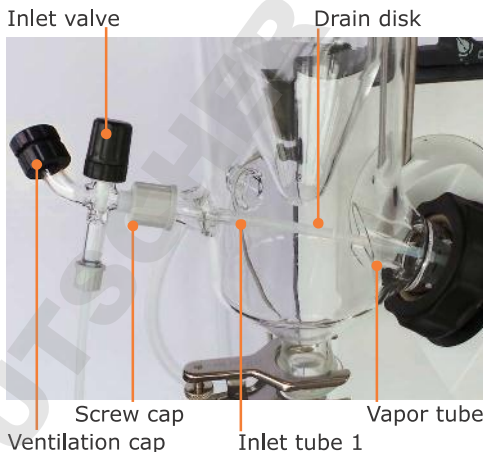

Inlet tube 2

- Unscrew the screw cap including the seal ring of inlet opening.
- Slide seal ring and screw cap approx. 3 cm onto PTFE tube.
- Insert PTFE tube with seal ahead into inlet opening and tighten screw cap.
- ✓ Inlet tubes are mounted.

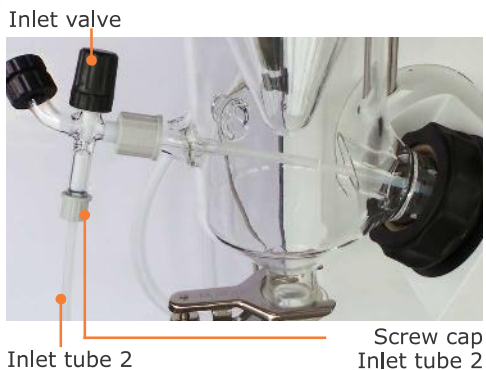

Inlet tubes glassware set G1

Openings for inlet tubes are located on the top of the condenser.





Vapor temperature sensor, AUTOaccurate sensor

Vapor temperature sensor

(Optional accessory, Hei-VAP Advantage only)

AUTOaccurate sensor

(Glassware set G3 and G6 and upgrade to Hei-VAP Precision only)

Opening for vapor temperature sensor and AUTOaccurate sensor is located at the bottom of the condenser.

Opening vapor temperature sensor



- Remove sealing cap of condenser.
- Insert vapor temperature sensor into condenser.
- Tighten vapor temperature sensor with screw cap.
- Plug in connector plug with white mark upwards into receptacle on the left side of unit.

Connector plug vapor temperature sensor



Screw cap vapor temperature sensor

Evaporating flask angle and depth

Evaporating flask angle

Evaporating flask angle can be adjusted by turning the drive.

- ✓ Rotation is set to 0 rpm.
- ✓ Evaporating flask is mounted (see chapter "Operation", section "Mount evaporating flask").
- Hold condenser with your left hand.
- Slide locking mechanism on lift pillar to the right and hold it against the spring force.
- Move condenser carefully until connected evaporating flask has the correct angle.
- Release locking mechanism.
- If necessary move condenser slightly until it locks in.

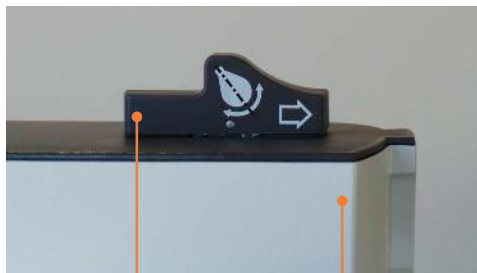

Locking

Lift pillar



Flask depth

A stop bolt is located on the right side of the lift pillar with which you can adjust a constant depth for the evaporating flask.

- ✓ Rotation is set to 0 rpm.
- ✓ Evaporating flask is mounted (see chapter "Operation", section "Mount evaporating flask").
- ✓ Height stop is at top position.

Adjust height without guard hood:

- Move down lift until it has reached the desired depth (see chapter "Start-Up, Heating bath and lift").
- Turn fixing screw on stop bolt of lift pillar approx. 180° counter clockwise.
- Slide stop bolt via fixing screw downwards as far as it will go.
- Fasten fixing screw clockwise.
- Move the lift upwards.
- ✓ The fixing screw allows to individually adjust the lowest flask position.
- ✓ The lift cannot be lowered beyond this point.

Adjust height with guard hood:

- Hold guard hood with one hand.
- Move guard hood manually when adjusting the lift.

Fixing screw



Lift contact

Stop bolt



Control panel

Control panel can be removed from console to be fixed to a wall or fume hood.
Connection cable is 1 meter long.



Warning: Risk of poisoning!

If operating with control panel inside of fume hood, there is a risk of harm if fume hood is opened during process.

Remove control panel and place it outside the fume hood.



Avertissement : Risque d'intoxication !

En cas d'exploitation avec le panneau de contrôle à l'intérieur de la hotte, il existe un risque physique si la hotte est ouverte pendant le processus.

Retirer le panneau de contrôle et le placer hors de la hotte.

Open cable carrier

- Grab control panel on the top left side and tip it to the front.
- Avoid pressure to the LCD display.
- ✓ The cable winding is surrounded by a shell.
- Pull shell of cable winding open.
- Wrap cable to the desired length on or off.



Position control panel

- If necessary turn shell 180°.
- Press shell and control panel together until they lock audibly.
- Place control panel on a clean and stable surface or attach it to a wall.



Insert control panel into console

- Turn shell into initial position with the wide side downwards.
- Wrap cable up to the yellow colored cable mark.
- Press shell and control panel together.
- If necessary plug in connecting plug with white colored tag upwards into console.



Yellow cable mark



- Place control panel with an angle of approx. 30° forward into the console.
- Press control panel into console until it locks audibly.



➤ Connecting peripheral devices

Connect vacuum



Warning / Attention:
Risk of implosion and poisoning/
Risque d'implosion et d'empoisonnement



Flasks which show even the slightest signs of damage may burst and depending on the solvent poison the environment./
 Les flacons qui montrent des signes de dommage peuvent éclater et en fonction du solvant peuvent empoisonner l'environnement.

Increase vacuum pressure and/or leakage pressure only if necessary. Do not increase pressure/under-pressure beyond the limit required by your solvents./

Augmenter la pression du vide et/ou la pression de fuite seulement si cela est nécessaire. Ne pas augmenter la pression ou le vide au-delà de la limite requise par vos solvants.

To connect the vacuum you need:

- a vacuum source
- a vacuum tube (Ø 7-8 mm inside)

Glassware set G1, G3 and G6

The opening of the vacuum connection is located on the top of condenser

- Unscrew either one of the screw caps with nipple.
- Push vacuum tubing onto nipple.
- Tighten screw cap with nipple and tubing.
- Connect other end of vacuum tube with vacuum source.

Vacuum connection G1, G3 and G6



Screw caps vacuum

Glassware set G5

The opening for vacuum connection is located on the top of condenser.

Vacuum connection G5

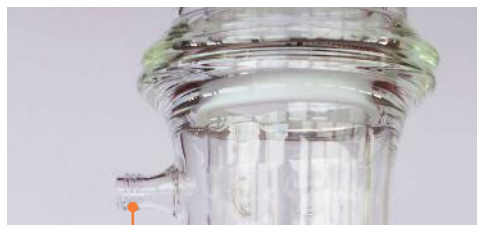

Opening vacuum connection



Connect cooling water



Warning:
Risk of explosion

A closed valve in the recirculation system will build up high pressure in the glassware and may result in glass bursting.

The pressure in the condenser shall not exceed 2 bar to ensure that a higher pressure never occurs.

No valve or restriction may be built into the recirculation system.

Assembly parts:

- 2x tube nipples
(included in scope of delivery)
- 1x tube, inner Ø 7-8mm
(not included in scope of delivery)

Tube nipples



Input and output for cooling water is located on the back of condenser.

Input and output cooling water

- Remove screw cap from input and output of the cooling water.
- Push screw cap over tube nipples so that the black seal is placed inside the cap.
- Push intake and outflow hoses for cooling water through screw cap over one of each tube nipple.
- Tighten screw cap with seal side up to the openings of condenser.
- ✓ Intake and outflow of cooling water are connected.

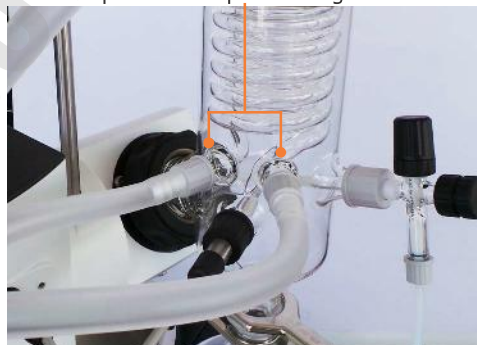



Mount tubes

To mount tubes a tubing clamp is located on the back of device.



➤ Additional accessories

Guard hood

- Fix carrier guard hood at height stop with two allen screws supplied.
- Release clamping screw and align guard hood while moving it horizontally.
- Tighten clamping screw
- ✓ Guard hood is mounted.
- Open guard hood with handle.

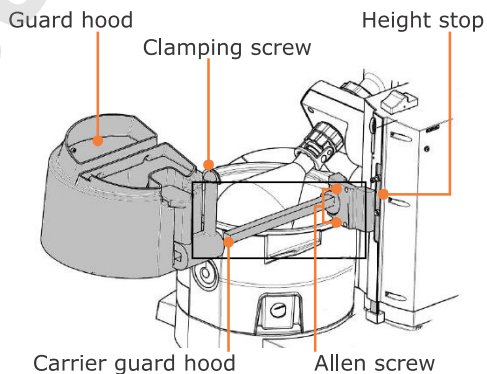

Safety shield

- Move lift upwards.
- Pull up safety shield to heating bath and place it so that the guard hood can be opened easily, where applicable.
- Turn eccentric screw 180° and fix safety shield to heating bath.

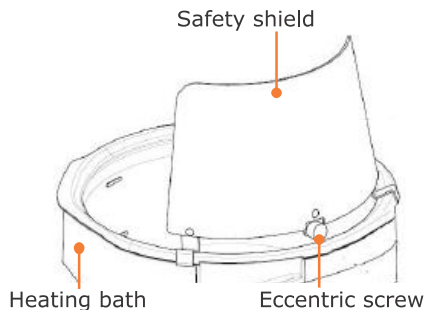



➤ Dismantling, transportation and storage

Dismantling

**Warning:****Risk of scalding!**

Hot glass surfaces and heating bath fluids may result in scalding prior to dismantling.

Ensure that all parts have cooled down to room temperature.

**Risk of poisoning!**

Minor leakages may result in solvents and toxic substances being released into the environment.

Ensure that fluids and solvents are collected in appropriate vessels.

Ensure that the surface of the unit is not contaminated with solvents and hazardous materials.

To clean the unit you may run a distillation with harmless substance.

**Risk of electric shock!**

If the device is still connected to power during dismantling, you might get in contact with live parts.

Prior to dismantling unit ensure that the unit is switched off and the plug is pulled from the electric socket.

**Avertissement :****Risque de brûlures !**

Les surfaces en verre chaudes et les liquides du bain chauffant peuvent entraîner des brûlures avant le démontage.

S'assurer que toutes les pièces ont refroidi jusqu'à température ambiante.

**Risque d'intoxication !**

Des fuites mineures peuvent entraîner l'exposition de l'environnement à des solvants et des substances toxiques.

S'assurer que les liquides et les solvants sont récupérés dans les récipients appropriés.

S'assurer que la surface de l'unité n'est pas contaminée par des solvants et des matériaux dangereux.

Pour nettoyer l'unité, il est possible de réaliser une distillation avec une substance non dangereuse.

**Risque d'électrocution !**

Si l'appareil est toujours raccordé à l'alimentation lors du démontage, il existe un risque de contact avec des parties sous tension.

Avant le démontage de l'unité, s'assurer que l'unité est éteinte et débranchée de la prise électrique.



- ✓ The unit is switched off.
- Remove all connections to cooling water, vacuum and other devices.
- Remove all glass ware and heating bath.

Motor lift

- Switch unit ON.
- Move lift downwards as far as it will go.
- Screw transportation lock while holding down lift contact.
- Switch the unit OFF.
- Disconnect plug from power socket and unit socket.

Transportation and storage

- Store and transport the unit and its components only if they were emptied and cleaned.
- Store and transport the unit and parts of unit in the original packing material or alternatively in an adequate container to prevent damage.
- Seal the package carefully against unauthorized or accidental opening.
- Store the unit in a dry and frost-free place.



Improper storage and transportation may result in damages to the system and the mechanical components.

Avoid any kind of shocks during transportation.



➤ Scope of delivery

Component	Variant	Quantity	Product number
Model with hand lift and glassware set G3: Hei-VAP	Value	1	560-01300-00
	Value Digital	1	560-01302-00
	Advantage	1	561-01300-00
Model with motor lift and glassware set G3: Hei-VAP	Advantage	1	562-01300-00
PTFE/FKM seal		1	23-30-01-01-30
Vapor tube		1	514-00000-01
Clamping sleeve		1	23-30-01-05-31
Transportation lock (motor lift)		1	11-300-006-28
Coupling		1	23-09-03-01-03
Tension ring		1	22-03-02-01-05
Flask clamp Easy-Clip NS 29		1	23-30-01-05-29
Flask clamp Easy-Clip NS 24		1	23-30-01-05-57
Joint clamp		1	515-42000-00
Operating Manual English / German		1	01-005-004-79
Warranty registration / Confirmation of condition		1	01-006-002-78
EU Declaration of Conformity		1	01-001-025-01
Power cord		1	depending on country

➤ Accessories

Component	Quantity	Product number
Device fuses (115 V and 230 V)	2	11-300-009-40
Vapor temperature sensor	1	569-00030-00
Guard hood	1	569-00010-00
Tube (suitable for vacuum and water)	1	591-35000-00
PTFE/FFKM seal	1	23-30-01-06-70
Glassware set		see general catalog
Vacuum pumps and chillers type and size vary		see general catalog

Additional accessories are shown in the general catalog or on our website at www.heidolph.com



Technical data

Hei-VAP Value, Hei-VAP Value Digital, Hei-VAP Advantage

Standard supply voltage	230 V/50 Hz or 115 V/60 Hz	
Supply power (W)	1400	
Protection class (DIN EN 60529)	<ul style="list-style-type: none"> ▪ IP 20 device ▪ IP 67 cable heating bath 	
Lift distance (mm)	155	
Drive	EC motor	
Rotation speed (rpm)	10 - 280	
Speed control	electronic	
Heating bath	<ul style="list-style-type: none"> ▪ inner Ø: 253 mm, outer Ø: 291 mm ▪ Material: V4A-steel (1.4404) stainless steel X2CrNiMo 17-12-2 ▪ Volume 4,5 L 	
Heating capacity (W)	1,300	
Temperature range (°C)	20 - 100 H ₂ O / 20 - 210 oil	
Temperature control	electronic	
Temperature accuracy	±1	
Heating bath (°C)		
Overtemperature protection heating bath	cut off at 5 °C difference to set temperature	
Overheat protection (°C)	250	
Condensing surface (cm ²)	1,400	
Airborne noise level	< 85 db(A)	
Permissible ambient conditions	<ul style="list-style-type: none"> ▪ 5 - 31 °C at 80 % relative humidity, no condensation ▪ 32 - 40 °C linear decrease down to 50 % relative humidity ▪ up to 2,000 m (6,500 feet) height above sea level 	
Evaporation rates (L/h) ΔT* = 40°C (continuous operation)	<ul style="list-style-type: none"> ▪ Toluene 8,5 ▪ Acetone 5,8 ▪ Ethanol 3,5 ▪ Water 1,2 	
Lift	Manual	Motor
Weight (without glassware) (kg)	14.7	15
Lifting speed (mm/s)	-	25
Dimensions with glassware set G3 (w x d x h) (mm)	739 x 490 x 887	739 x H 420 x 887
Device	Value Digital	Advantage
Display bath temperature (°C)	digital	digital
Display vapor temperature (°C)	-	digital (required: vapor temperature sensor)
Display rotation speed	-	digital
Timer	-	yes

* ΔT = Difference between heating bath temperature and boiling temperature



> Contact / Technical Service

Questions / Repair work

If any aspect of installation, operation or maintenance remains unanswered in the present manual, please contact us.

For repairs please call Heidolph Instruments or your local authorized Heidolph distributor.



Warning: Danger of poisoning!

Contaminated units can lead to severe injury or death of our employees!

When shipping items for repair that may have been contaminated by hazardous substances, please

- advise exact substance
 - take adequate protective action towards our parts receiving and service personnel
 - mark the pack in accordance with Ordinance on Hazardous Substances
-



Avertissement : Danger d'intoxication !

Les unités contaminées peuvent entraîner des blessures graves ou la mort de nos employés !

Lors de l'expédition de pièces pour la réparation qui peuvent avoir été contaminées par des substances dangereuses, veuillez

- indiquer la substance exacte
 - prendre les mesures protectrices adéquates vis-à-vis de nos parties réceptrices et notre personnel de réparation
 - classer l'emballage selon l'Ordonnance relative aux substances dangereuses
-

Included at the end of this manual you will find a „Confirmation of condition of unit“.

→ Kindly copy and fill in this form and submit it prior to shipping the unit for repair.



Contact details:



Heidolph Instruments Germany

Heidolph Instruments GmbH & Co. KG
Technical Service
Walpersdorfer Str. 12
D-91126 Schwabach / Germany

Tel.: +49 - 9122 - 9920-74
Fax: +49 - 9122 - 9920-84

E-Mail: service@heidolph.de
www.heidolph.de

Heidolph Instruments North America

Phone: 1-866-650-9604
E-mail: service@heidolph.com
www.heidolphNA.com

Heidolph Instruments United Kingdom

Phone: 01799 - 5133-20
E-mail: service@radleys.co.uk
www.heidolph-instruments.co.uk

All other countries

You will find contact details of your local Heidolph distributor at
www.heidolph.com

Warranty



Heidolph Instruments provides a 3-year warranty for the products described here (excluding glass and wearing parts) if you register using the warranty card enclosed or online (www.heidolph.com). The warranty is valid from the point of registration. The serial number is also valid without registering.

The warranty covers part and manufacturing defects.

In the case of a part or manufacturing defect, the device shall be repaired or replaced free of charge under the terms of the warranty.

Heidolph Instruments shall not assume liability for any damages incurred as a result of improper handling or transport.

Warranty claim?

→ Please inform Heidolph Instruments or your local Heidolph distributor should you wish to make a warranty claim.



Confirmation of condition of unit

→ In the case of repair, copy and complete the Confirmation of condition of unit and send it to Heidolph Instruments.

1. Details about the unit

Product number

Serial number

Reason for repair

2. Has the device been cleaned, decontaminated/sterilized?

Yes

No

3. Is the unit in a condition which does not represent any health threats for the staff of our service department?

Yes

No

If not, which substances has the unit come into contact with?

4. Legally binding declaration

The customer is aware of being legally liable to Heidolph Instruments for any damages arising from incomplete and incorrect information.

Date

Signature

Company stamp

Please note

The shipper is responsible for the return of the goods in well packed condition, suitable for the mode of transport.

Sender information

Name, first name

Company

Department, research group

Street

Zip code, city

Country

Phone

E-mail



➤ Déclaration de non-opposition

→ En cas de panne, vous pouvez copier, remplir, puis nous envoyer / faxer la présente déclaration à Heidolph Ins-truments GmbH & Co KG.

1. Description de l'appareil

Type _____

Numéro de série _____

Motif de l'envoi _____

2. L'appareil a-t-il été nettoyé, le cas échéant décontaminé / désinfecté ?

Oui _____

Non _____

3. L'appareil représente-t-il des risques sanitaires pour les réparateurs ?

Oui _____

Non _____

Si non, avec quelles substances
l'appareil a-t-il eu contact ?

4. Déclaration de conformité

Le mandant déclare avoir pris connaissance de sa responsabilité envers le mandataire quant aux dommages dus à des informations incomplètes ou erronées.

Date _____

Signature _____

Company stamp _____

Please note

The shipper is responsible for the return of the goods in well packed condition, suitable for the mode of transport.

Expéditeur

Nom / Prénom _____

Société _____

Service _____

Adresse _____

CP / Ville _____

Pays _____

Téléphone _____

E-mail _____



MADE IN
GERMANY

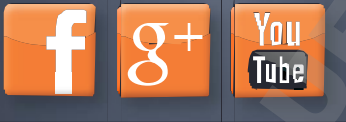

01-005-004-79-2b, 06.12.2016

© Heidolph Instruments GmbH & Co. KG

This is a translation of the original operating manual. We reserve the right to make any technical modifications without prior notification. This documentation is not subject to revision; the latest version of this documentation can be found on our homepage. The copyright for all texts and images is held by Heidolph Instruments GmbH & Co. KG.

Technische Änderungen sind ohne vorherige Ankündigung vorbehalten. Diese Dokumentation unterliegt keinem Änderungsdienst, neueste Stände dieser Dokumentation finden Sie auf unserer Homepage. Das Urheberrecht für Texte und Bilder liegt bei Heidolph Instruments GmbH & Co. KG.