



# Intelligent Evaporation

Leading Safety Standards

Superior Ease of Use

Reduced Cost of Ownership

 **heidolph**  
research made easy



Do you demand the highest safety standards, perfectly engineered ease of use and reduced cost of ownership?

## Intelligent Evaporation...

... stands for an overheat protection design that prevents water baths running dry, provides a detachable panel for superior ease of use from outside closed fume hoods and offers a proven vacuum seal and vapor tube system guaranteed for years of operation!

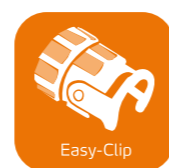
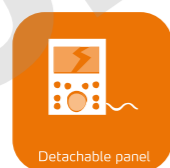

## Leading **Safety Standards**

- Two independent safety circuits **avoid an overheat situation** of your heating bath: If bath temperature overshoots by 5 °C and if your water bath runs dry, heating will be switched off automatically
- To avoid** an overtemperature situation and potential **thermal damage** to your sample, you can individually pre-program a maximum temperature on the Hei-VAP Precision, at which the bath powers off
- In case of a power cut, all motor lift models will remove the flask from the heating bath **preventing safety hazards** and potential thermal damage to your sample
- To protect you from splashes and scalding**, the Hei-VAP heating bath features an integrated pour spout to remove bath fluid safely
- Heating bath is constructed with a **double wall** for your protection against burns and scalding
- The guard hood **covers the entire bath completely** even if the heating bath is adjusted horizontally to its most extreme limit
- A **metal support** between the heating bath and the base unit **prevents bath instability**
- To **protect** your heating bath **against short-circuits and systematic corrosion**, the cable coupling complies with the protection class IP 67
- For your protection, the operating panel is located near the base so as to **keep your hands out of the dangerous zone** of rotating flasks, steam and splashing bath fluids
- All heating baths feature **non-slip handles** with safety grip to protect you from scalding bath liquids and allow for easy installation/removal of the bath
- A separate on/off switch for heating **prevents unintentional heat-up**. The button is illuminated for visual control
- In case of an overshoot of any parameter setting, all models will show a **warning on the operating panel**
- Glassware assemblies are optionally available with **transparent plastic safety coating** ensuring ultimate protection while allowing visual control at all times
- IQ-OQ documentation** is available for Hei-VAP models on request

### ➤ Hei-VAP heating bath



#### YOUR ADVANTAGES

- Only the Hei-VAP heating bath reaches a temperature of 210 °C
- The universal heating bath can even accommodate 5-liter flasks
- The heating bath can be adjusted horizontally up to 200 mm
- To prevent short circuits and corrosion, the cable coupling complies with the protection class IP 67
- Non-slip handles for safe transportation eliminate the risk of scalding
- An integrated pour spout to remove bath fluid safely

## Superior **Ease of Use**

- The detachable operating panel can be attached via velcro or with a special suspension at eye level for your convenience from **outside closed fume hoods**
- The patented evaporating flask **clamp Easy-Clip cannot be lost** due to a connection to the vapor tube coupling ring
- The integrated screwed ring allows you to **remove sticking evaporating flasks** from the vapor tube **just in seconds** in a safe manner
- The universal heating bath can be adjusted horizontally up to 200 mm and offers efficient space to **accommodate even 5-liter flasks**
- For your convenience, the **height of 160 mm** and the **angle** of the evaporating flask can be **adjusted easily from 20° to 80°**
- The optional automatic module Distimatic Bench-top allows for **continuous and unattended automatic operations**

## **Reduced Cost** of Ownership

- **Reduce your process times** up to 30 %
- The chemical-resistant vacuum seal **reduces your spare parts budget** up to 75 % with prolonged operational lifespan
- The patented clamping sleeve ensures a **long life performance of the vapor tube**
- Increase your range of applications by using 5-liter flasks in the universal bath at **no additional cost**
- Maintenance-free and non-sparking motors **reduce repairs and down times significantly** to ensure years of continuous operation
- The flange on the condenser side of the drive is made of PPS (Polyphenylene sulfide), a robust industrial-designed resin with **superior chemical resistance** which provides more chemical resistance than stainless steel or welded aluminum. This reduces corrosion to a minimum which results in additional savings on maintenance and replacement components
- Only Hei-VAP heating baths reach a temperature of 210 °C which is 30 °C higher than other evaporators on the market and allow for a **broader range of applications** which previously could not be performed on any rotary evaporator (for example bitumen distillation). Thus, increasing the range of applications eliminates the need for investment in other equipment
- Spend your working hours more effectively on other challenges which require your attention and **evaporate large quantities continuously** with the automatic module Distimatic Bench-top
- Maximize your initial investment significantly: the automatic module Distimatic Bench-top is an **affordable and more flexible alternative** to large-scale rotary evaporators
- Reduce your maintenance costs. The sealed housing protects your rotary evaporator from aggressive fumes, liquids and vapors to prevent internal corrosion. This results in an **increased lifespan of 10 years** on average at a reduced maintenance and repair cost

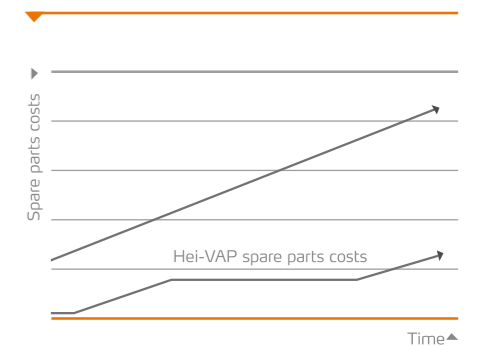

# Intelligent Evaporation

Leading Safety Standards

Superior Ease of Use

Reduced Cost of Ownership

## Vapor tube with patented clamping sleeve

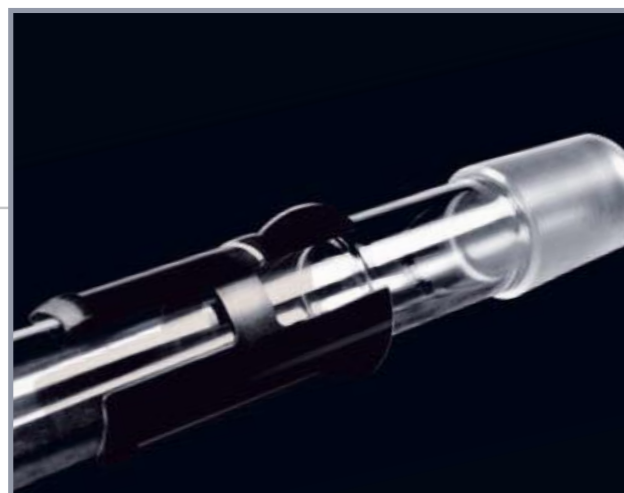

### YOUR ADVANTAGES

- The patented clamping sleeve system allows easy removal of the vapor tube from the drive
- Years of performance life reduce your spare parts budget up to 75 %
- The Hei-VAP vapor tube does not get stuck in the drive, thus eliminating the risk of broken glass
- Immediate removal of the vapor tube from the drive facilitates your work

## Patented flask clamp Easy-Clip



### YOUR ADVANTAGES

- Easy-Clip can't get lost due to a direct connection to the drive
- The integrated screw thread allows an easy removal of sticking flasks
- The Easy-Clip is made of highly resistant synthetic material which ensures a long life performance

## Operating panel



### YOUR ADVANTAGES

- Changing all parameters from outside closed fume hoods guarantees the highest safety level
- Standard for all models is a panel with 1 m cable connection. Thus data security is guaranteed at any time
- Immediate access to the panel ensures ultimate control of the process while increasing your ease of use
- A separate on/off switch for heating prevents unintentional heat-up – the button is illuminated for visual control

The average operational **lifespan of 10 years** is backed by a **3 year warranty** and makes your purchase a worthwhile investment.

Chemical-resistant **vacuum seal** allows for **years of operation** and reduces spare parts budget up to 75 %

Bath power cable coupling complies with protection class IP 67 to **prevent corrosion and short circuits**

Detachable panel allows for the **highest operational safety** from outside closed fume hoods

**Continuous unattended evaporation without limits** - the automatic module Distimatic Bench-top with automatic drainage of residue is an affordable and more flexible alternative to large-scale rotary evaporators

The flange made of **chemical-resistant PPS** reduces corrosion, maintenance and spare parts cost to a minimum

**Non-sticking vapor tube** with patented clamping sleeve eliminates broken glass and reduces spare parts cost significantly

The **patented Easy-Clip** provides an **easy removal** of sticking flasks and **can't get lost** due to the direct connection to the drive

**Safety bath** will power off if temperature overshoots by 5 °C or runs dry

**210 °C heating bath** with safety handles and pour spout accommodates **5-liter flasks**



A separate on/off switch for heating **prevents unintentional heat-up** – the button is illuminated for visual control

**A metal support** between the heating bath and the base unit **prevents bath instability**

## ➤ Hei-VAP Value / Hei-VAP Value Digital

### Affordable model with hand lift for all standard applications

Includes leading safety standards and features for superior ease of use and reduced cost of ownership, plus:

- The convenience of large dial controls for adjustment of rotation speed and bath temperature
- For limited budgets, we recommend the optional Manual vacuum controller
- **Hei-VAP Value Digital** models come with a digital display for set and actual heating bath temperature
- **Hei-VAP Value** models have no digital display



**Hei-VAP Value Digital HL/G3**  
P/N 560-01302-00

Model	Hei-VAP Value hand lift (HL)		Hei-VAP Value Digital hand lift (HL)	
	standard	coated	standard	coated
G1 Diagonal	560-01100-00	560-01110-00	560-01102-00	560-01112-00
G3 Vertical	560-01300-00	560-01310-00	560-01302-00	560-01312-00
G5 Dry Ice Condenser	560-01500-00	560-01510-00	560-01502-00	560-01512-00
G6 Vertical for Reflux	560-01600-00	560-01610-00	560-01602-00	560-01612-00

## ➤ Hei-VAP Advantage

### For your routine distillation applications and reproducible results

Includes leading safety standards and features for superior ease of use and reduced cost of ownership, plus:

- Available in hand lift or motor lift configurations
- Experience the advantages of our large digital 3.5" LCD display which indicates rotation speed, heating bath and vapor temperature
- We recommend the optional Manual vacuum controller
- Experience the advantages of the automatic process timer which turns off your evaporator at a pre-programmed time and removes evaporating flasks from bath on motor lift models
- Upgrade your Hei-VAP Advantage to a Hei-VAP Precision:



**Hei-VAP Advantage ML/G3**  
P/N 562-01300-00

**Upgrade-KIT Advantage Precision-HL**  
P/N 569-30009-00

**Upgrade-KIT Advantage Precision-ML**  
P/N 569-40009-00

Model	Hei-VAP Advantage hand lift (HL)		Hei-VAP Advantage motor lift (ML)	
	standard	coated	standard	coated
G1 Diagonal	561-01100-00	561-01110-00	562-01100-00	562-01110-00
G3 Vertical	561-01300-00	561-01310-00	562-01300-00	562-01310-00
G5 Dry Ice Condenser	561-01500-00	561-01510-00	562-01500-00	562-01510-00
G6 Vertical for Reflux	561-01600-00	561-01610-00	562-01600-00	562-01610-00

## ➤ Hei-VAP Precision

### Most demanding applications and the finest integrated vacuum control capabilities

Includes leading safety standards and features for superior ease of use and reduced cost of ownership, plus:

- Available in hand lift or motor lift configurations
- Experience the advantages of our large 4.3" color graphic display which features all parameters, integrated vacuum controller and includes programs for automated distillations
- Make your life easier by utilizing the integrated software support which leads you through the capabilities of the evaporator
- For data management Hei-VAP Precision models feature a USB interface
- Save time by configuring the unit - all connected devices will be recognized by the evaporator, which eliminates the need to configure the unit manually
- Now you can manage even the most demanding applications easily and prevent foaming, excessive bubbling or bumping
- Save time with your individualized pre-programmed parameter settings for your 30 most common applications used on a daily basis by saving them in a "Favorites" section
- Each ramp offers 20 separate steps for demanding applications
- Apply an individual name to those ramps to avoid a mix-up
- Experience the advantages of the automatic process timer which turns off your evaporator at a pre-programmed time by raising the flask on motor lift models and releasing vacuum
- Control your process individually by pre-programming vacuum gradients
- Hei-VAP Precision models feature a built-in vacuum controller as a standard



Hei-VAP Precision ML/G3  
P/N 564-01300-00

For increased safety all bath temperature adjustments can be limited

Even from a distance you will be able to monitor the numbers on the display easily

Large color graphic display for all parameters and automated programs

### Programs facilitate process control

Reduce your process times significantly by using these three programs for automated distillation

#### SET<sub>pressure</sub>

##### Program for solvent separations

This program holds a pre-set vacuum constant. During the evacuation you have the full flexibility to choose another level of vacuum by the press of a button

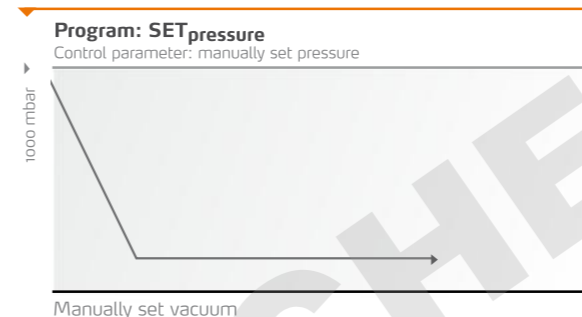

#### AUTO<sub>easy</sub>

##### Supports the automatic pressure control for solvent separations

The pressure level for the first boiling point is found automatically. This program can be used with all Heidolph glassware assemblies and does not require any accessories

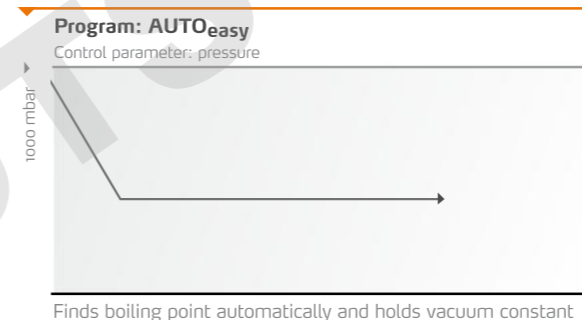

#### AUTO<sub>accurate</sub>

##### Supports very precise automatic pressure control for solvent separations

This program works similar to AUTO<sub>easy</sub> but in addition is able to identify multiple boiling points automatically by reducing vacuum accordingly. Also the AUTO<sub>accurate</sub> program delivers the finest and most precise vacuum control. To take advantage of this program, the optional AUTO<sub>accurate</sub>-sensor is required. This program cannot be used on Heidolph G1 and G5 glassware assemblies. Leading parameter of this program is the vapor temperature

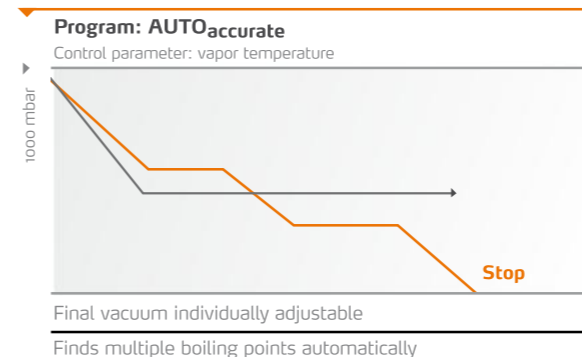

### ➤ Reduce your process times via automated distillation programs

Model	Hei-VAP Precision hand lift (HL)		Hei-VAP Precision motor lift (ML)	
	standard	coated	standard	coated
G1 Diagonal	563-01100-00	563-01110-00	564-01100-00	564-01110-00
G3 Vertical	563-01300-00	563-01310-00	564-01300-00	564-01310-00
G5 Dry Ice Condenser	563-01500-00	563-01510-00	564-01500-00	564-01510-00
G6 Vertical for Reflux	563-01600-00	563-01610-00	564-01600-00	564-01610-00

# Hei-VAP Precision

for the highest level  
of accuracy

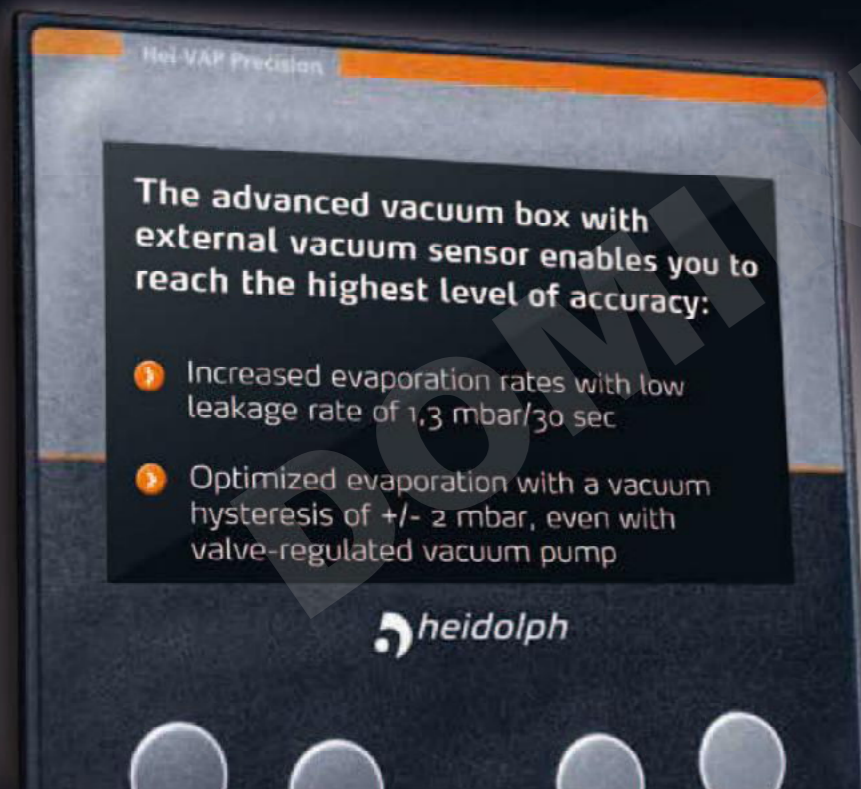

## ➤ Vacuum Pumps

Advantages of all chemical-resistant diaphragm vacuum pumps



- All components which come in contact with media are built from chemically resistant fluoropolymer
- The durable PTFE design guarantees an superior diaphragm lifespan
- The head cover and clamping disc have a stable core made of metal which offers unsurpassed long-term performance of your operational parameters
- The direct pump drive (without belt) is exceptionally quiet, creates a very low vibrational environment and reduces the need of wear and tear parts to a minimum
- The gas ballast valve has been optimized to prevent media condensing in the pump

## ➤ RPM Regulated Vacuum Pumps

RPM regulated pumps adjust their speed individually and come to a complete stop when the required vacuum level is reached

### YOUR ADVANTAGES

- Speed adjustment stops completely if vacuum is reached and runs intermittently at very low speed to hold vacuum constant
- Increased diaphragm performance life due to periods of non-operation
- Low energy consumption due to intermittent operation
- Significant noise and vibration reduction due to periods of non-operation
- Operates without vacuum valve
- Most precise vacuum level at all times

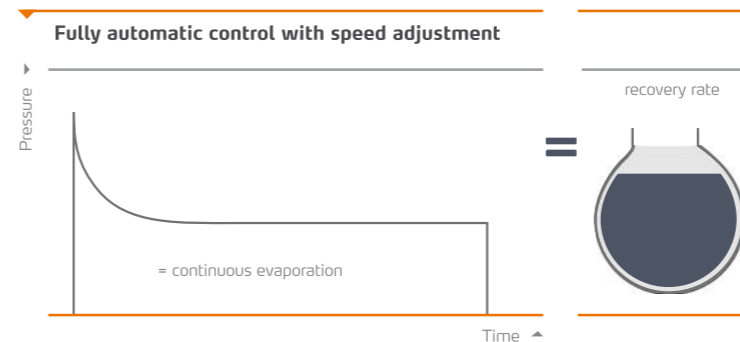

- Highest distillation rates possible and reducing process time by 30 %
- Stable distillation conditions account for solvent recovery up to 100 %

## ➤ RPM Regulated Vacuum Pumps

### Rotovac Vario Pumping Unit

Fully controllable stand-alone pumping unit including vacuum controller.  
For Hei-VAP Value and Hei-VAP Advantage



### Rotovac Vario Pumping Unit

P/N 591-00142-00

#### Condenser

P/N 591-00084-00

- Three-stage diaphragm pump is made from chemical-resistant material
- High suction capacity of 1.7 m<sup>3</sup>/h for fastest evacuation
- Achieves an ultimate vacuum of 5 mbar
- Precise vacuum control avoids bumping and eliminates foaming of your evaporation solution
- Due to automatic vacuum supply to the process parameters you have more time for important laboratory activities
- Can be combined with a condenser
- Power input: 160 W, Weight: 6.0 kg
- Dimensions (without condenser): L263 / W193 / H299 mm

### Rotovac Vario Tec

For Hei-VAP Precision



### Rotovac Vario Tec

P/N 591-00171-00

#### Condenser

P/N 591-00084-00

- Two-stage diaphragm pump is made from chemical-resistant material
- Suction capacity of 1.0 m<sup>3</sup>/h
- Achieves an ultimate vacuum of 12 mbar
- Recommended for solvents with low or medium boiling points
- Can be combined with a condenser
- Power input: 160 W, Weight: 4.3 kg
- Dimensions (without condenser): L156 / W236 / H196 mm

### Rotovac Vario Control

For Hei-VAP Precision



### Rotovac Vario Control

P/N 591-00141-00

#### Condenser

P/N 591-00084-00

- Three-stage diaphragm pump is made from chemical-resistant material
- High suction capacity of 1.7 m<sup>3</sup>/h for fastest evacuation
- Achieves an ultimate vacuum of 2 mbar
- Even if the gas ballast valve is open an excellent ultimate vacuum is reached when working with easily condensable vapors. This makes distilling high boiling point solvents such as DMF or DMSO possible at low bath temperatures
- Can be combined with a condenser
- Power input: 160 W, Weight: 5.4 kg
- Dimensions (without condenser): L167 / W236 / H196 mm

## ➤ Valve-Regulated Vacuum Pumps

Standard vacuum pumps can be controlled manually or via valve operated vacuum controllers

### Rotovac Valve Tec

For all Hei-VAP models



### Rotovac Valve Tec

P/N 591-00160-00

#### Condenser

P/N 591-00083-00

- Two-stage diaphragm vacuum pump made of chemical-resistant material
- Suction capacity of 0.75 m<sup>3</sup>/h
- Achieves an ultimate vacuum of 12 mbar
- Recommended for solvents with low or medium boiling points

- Vacuum can be controlled manually or via valve operated vacuum controllers
- Can be combined with a condenser
- Power input: 80 W, Weight: 6.0 kg
- Dimensions (without condenser): L145 / W315 / H169 mm

### Rotovac Valve Control

For all Hei-VAP models



### Rotovac Valve Control

P/N 591-00130-00

#### Condenser

P/N 591-00083-00

- Two-stage diaphragm pump made from chemical-resistant material
- High suction capacity of 2.0 m<sup>3</sup>/h for fastest evacuation
- Achieves an ultimate vacuum of 7 mbar
- Suction capacity for up to 3 rotary evaporators at the same time
- Vacuum can be controlled manually or via valve operated vacuum controllers

- Depending on your application you can switch on and off the vacuum pump via switchbox
- Can be combined with a condenser
- Power input: 180 W, Weight: 12.8 kg
- Dimensions (without condenser): L195 / W245 / H310 mm



## Chillers

### RotaChill Large

Highest cooling capacity



**RotaChill Large**  
P/N 591-00240-00

- Highest cooling capacity for any application
- Temperature range from -20 °C to +40 °C
- Temperature control accuracy of ±0.1 °C
- Digital display for temperature setting and reading out actual temperature
- Cooling capacity at +20 °C: 1,290 W
- Footprint of chiller: L607 / W254 / H483 mm

### Rotacool Mini

Ideal for standard applications



**Rotacool Mini**  
P/N 591-00210-00

- Chiller for all standard applications
- Temperature range from -10 °C to +40 °C
- Temperature control accuracy of ±1 °C
- Digital display for temperature settings and reading out actual temperature
- Cooling capacity at +20 °C: 580 W
- Footprint of chiller: L360 / W310 / H520 mm

### RotaChill Small

The affordable model



**RotaChill Small**  
P/N 591-00220-00

- Temperature range from 0 °C to +100 °C
- Precise temperature control accuracy of ±0.2 °C
- The RotaChill should be placed directly besides the evaporator to ensure a sufficient pump performance
- Footprint of chiller: L450 / W210 / H570 mm

	RotaChill Large	Rotacool Mini	RotaChill Small
Temperature range [°C]	-20 to +40	-10 to +40	0 to +100
Coolant volume [L]	2.7	3	6
Cooling capacity* at: +20 °C [W]	1,290	580	200
0 °C	750	370	140
-10 °C	-	80	-
-20 °C	260	-	-

\* at 20 °C ambient temperature

## Accessories



**Guard hood**  
P/N 569-00010-00

- Strong and transparent guard hood to protect you from implosions
- Provides easy and immediate access to flask and bath



**Guard shield**  
P/N 569-00020-00

- Strong and transparent guard shield for your protection while changing flasks
- Attached at the edge of the bath



**Vapor temperature sensor**  
P/N 569-00030-00

- For Hei-VAP Advantage and Hei-VAP Precision



**AUTOaccurate-sensor**  
P/N 569-00040-00

- For Hei-VAP Precision
- Only in combination with glassware set G3 and G6



**Tube set**  
P/N 591-35000-00

- Includes 6.25 meter vacuum tubing and 6.25 meter water tubing



**Spare PTFE vacuum seal**  
P/N 23-30-01-01-30



**Aqua-Stop**  
P/N 569-00500-00

The integrated valve closes automatically by turning off the evaporator. The system saves money by reducing your consumption of cooling tap water. Moreover the safety mechanism avoids flooding in your laboratory. (Only for Hei-VAP Advantage and Hei-VAP Precision)



**Spare clamping sleeve**  
P/N 23-30-01-05-31

**Spare vapor tube NS 29/32**  
P/N 514-00000-01



**Heating bath liquid**  
P/N 569-00600-00

- Heating bath liquid up to 220 °C (5 L)

## ➤ Glassware

- Glassware set includes one 1,000-ml evaporating flask and one 1,000-ml receiving flask
- All glassware sets are also available with transparent plastic coating for added safety
- Evaporating flasks and vapor tubes which come with a standard NS 29/32 joint size are also available with NS 24/29 ground joints
- Also available upon request: glassware sets for Soxhlet extraction and descending condenser system
- All glassware sets feature GL 10 thread; the inlet tube can be connected with a threaded fitting
- Glassware sets G3 and G6 allow for the automated distillation program AUTOaccurate on Hei-VAP Precision models

### Glassware set G1

- Diagonal condenser for all standard distillations; the option with the **most affordable price**

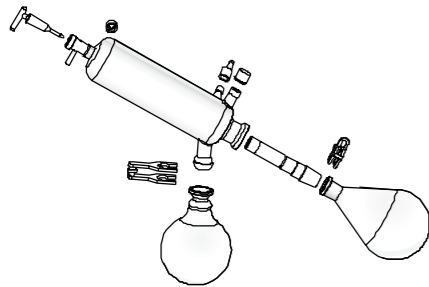

### Glassware set G5

- **Dry Ice** condenser for low-boiling solvents

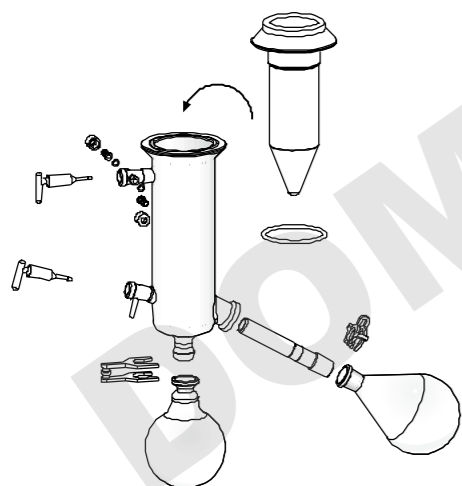

### Glassware set G3

- Vertical condenser for all standard distillations; the option with the **smallest space requirement**

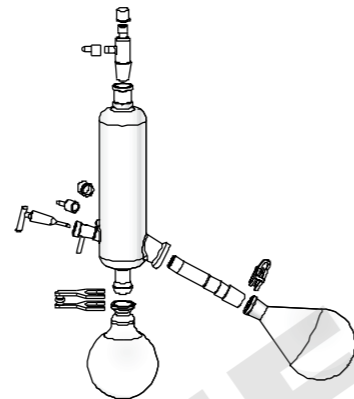

### Glassware set G6

- Vertical condenser; centerpiece with valve **for reflux distillation**

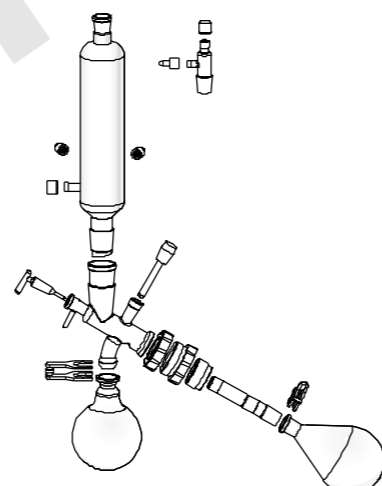

## ➤ Accessories



Evaporating flasks	NS 29/32	NS 24/29
Evaporating flask* 50 ml	514-70000-00	514-70000-01
Evaporating flask 100 ml	514-71000-00	514-71000-01
Evaporating flask 250 ml	514-72000-00	514-72000-01
Evaporating flask 500 ml	514-73000-00	514-73000-01
Evaporating flask 1,000 ml	514-74000-00	514-74000-01
Evaporating flask 2,000 ml	514-75000-00	514-75000-01
Evaporating flask 3,000 ml	514-76300-00	514-76300-01
Evaporating flask 5,000 ml	514-78000-00	514-78000-03

\* Evaporating flask NS 14.5 incl. adaptor (NS 29 or NS 24)



Receiving flasks	standard	coated
Receiving flask - NS 35/20 100 ml	514-81000-00	514-81000-02
Receiving flask - NS 35/20 250 ml	514-82000-00	514-82000-02
Receiving flask - NS 35/20 500 ml	514-83000-00	514-83000-02
Receiving flask - NS 35/20 1,000 ml	514-84000-00	514-84000-02
Receiving flask - NS 35/20 2,000 ml	514-85000-00	514-85000-02
Receiving flask - NS 35/20 3,000 ml	514-87000-00	514-87000-02



Powder flasks	NS 29/32	NS 24/29
Powder flask 500 ml	514-73200-00	514-73200-01
Powder flask 1,000 ml	514-74200-00	514-74200-01
Powder flask 2,000 ml	514-75300-00	514-75300-01

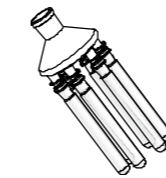

Spider	NS 29/32	NS 24/29
Spider with 6 distillation sleeves NS 14,5 20 ml	15-300-005-09	15-300-005-12
Spider with 12 distillation sleeves NS 14,5 20 ml	15-300-005-10	15-300-005-13
Spider with 20 distillation sleeves NS 14,5 20 ml	15-300-005-11	15-300-005-06



Spider	NS 29/32	NS 24/29
Spider with 5 flasks NS 24 50 ml	15-300-005-04	15-300-005-08
Spider with 5 flasks NS 24 100 ml	15-300-005-07	15-300-005-05



Evaporating cylinder	NS 29/32	NS 24/29
Evaporating cylinder 500 ml	514-00070-00	514-00070-01
Evaporating cylinder 1,500 ml	514-00071-00	514-00071-01



Foam brake	NS 29/32	NS 24/29
Foam brake with flask clamp	514-00004-00	514-00005-00

## ➤ Vacuum Accessories

### Switchbox

Connect up to 3 rotary evaporators to one vacuum pump



### Switchbox

P/N 569-00400-00

- Connect up to 3 rotary evaporators to one pump and control vacuum individually
- Pump switches off automatically at required vacuum
- Reduces energy consumption of pump
- Increases performance life of the pump due to a complete switch-off if vacuum is reached
- Vacuum valve and non-return valve are required for every evaporator if you work with different pressures at the same time
- Delivery includes 3 non-return valves
- Designed for Hei-VAP Precision
- Weight: 0.6 kg
- Dimensions: L80 / W160 / H45 mm

### Manual vacuum controller

For Hei-VAP Value and Hei-VAP Advantage



### Manual vacuum controller

P/N 591-26000-00

- Control your house vacuum or any other vacuum source
- Pressure range from 0 to 1,020 mbar
- Scaling on display in steps of 50 mbar
- Connection for tubes with 8 mm inner diameter
- Support rod included
- A vacuum valve is not required
- Dimensions: L80 / W80 / H150 mm

### Vacuum valve

Required to control vacuum for Hei-VAP Precision models with valve-regulated pumps



### Vacuum valve

P/N 569-00060-00

- External attachment design for easy cleaning
- Can be combined with the Woulff Bottle to one unit
- Not required if you utilize a Manual vacuum controller

### Woulff bottle

P/N 569-00070-00

- Additional recovery of solvent to protect vacuum valve and vacuum pump
- Compatible with all Hei-VAP configurations
- Direct connection to the vacuum valve is possible
- Features connection to vacuum controller
- Volume of 250 ml

## ➤ Equipment Combinations

### Rotary Evaporator



Hei-VAP Value / Hei-VAP Value Digital



Hei-VAP Advantage



Hei-VAP Precision

### Vacuum source

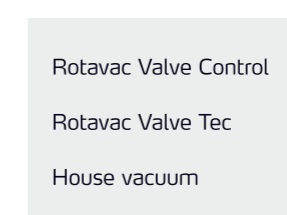
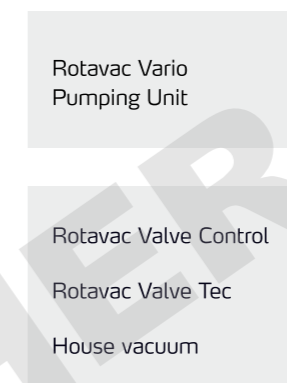

### Accessories

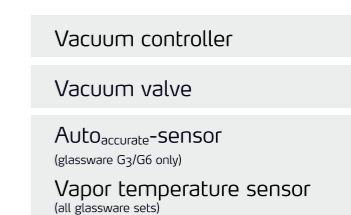
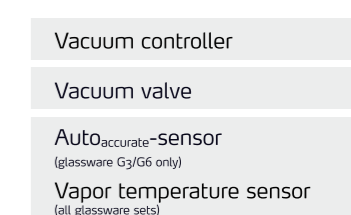
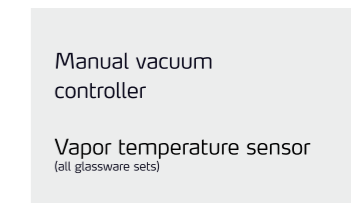
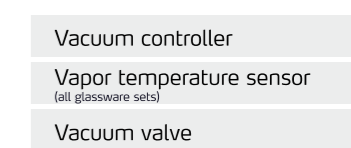
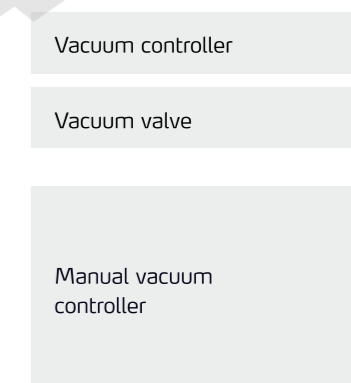

Rotavac Valve Control with condenser

Rotavac Valve Tec with condenser

Rotavac Vario Control with condenser

Rotavac Vario Tec with condenser

Rotavac Vario Pumping Unit with condenser

Manual vacuum controller

Vacuum valve with Woulff bottle

AUTOaccurate-sensor

Vapor temperature sensor

## ➤ Hei-VAP Packages



**Hei-VAP Silver 3 Package**  
P/N 560-91309-00



**Hei-VAP Gold 3 Package**  
P/N 562-91307-00



**Hei-VAP Platinum 2 Package**  
P/N 563-51310-00



**Hei-VAP Platinum 5 Package**  
P/N 564-31318-00

### Hei-VAP Silver Packages

Standard equipment for your lab

#### Hei-VAP Silver 1 Package

P/N 560-91300-00

- Hei-VAP Value with hand lift and vertical glassware set G3
- Vacuum pump Rotavac Valve Tec
- Manual vacuum controller
- Tube set

#### Hei-VAP Silver 2 Package

P/N 560-81310-00

- Hei-VAP Value with hand lift and coated vertical glassware set G3B
- Vacuum pump Rotavac Valve Control
- Manual vacuum controller
- Tube set

#### Hei-VAP Silver 3 Package

P/N 560-91309-00

- Hei-VAP Value with hand lift and vertical glassware set G3
- Vacuum pump Rotavac Valve Tec
- Manual vacuum controller
- Chiller RotaChill Small
- Tube set

#### Hei-VAP Silver 4 Package

P/N 560-91302-00

- Similar to „Hei-VAP Silver 1 Package“ but comes with Hei-VAP Value Digital

#### Hei-VAP Silver 5 Package

P/N 560-81312-00

- Similar to „Hei-VAP Silver 2 Package“ but comes with Hei-VAP Value Digital

#### Hei-VAP Silver 6 Package

P/N 560-91309-20

- Similar to „Hei-VAP Silver 3 Package“ but comes with Hei-VAP Value Digital

### Hei-VAP Gold Packages

For standard distillations with vacuum control

#### Hei-VAP Gold 1 Package

P/N 561-41300-00

- Hei-VAP Advantage with hand lift and vertical glassware set G3
- Vapor temperature sensor
- Vacuum pump Rotavac Valve Tec
- Manual vacuum controller
- Tube set

#### Hei-VAP Gold 2 Package

P/N 562-11310-00

- Hei-VAP Advantage with motor lift and coated vertical glassware set G3B
- Vapor temperature sensor
- Vacuum pump Rotavac Vario Pumping Unit
- Tube set

#### Hei-VAP Gold 3 Package

P/N 562-91307-00

- Hei-VAP Advantage with motor lift and vertical glassware set G3
- Vacuum pump Rotavac Valve Tec
- Manual vacuum controller
- Chiller Rotacool Mini
- Tube set

### Hei-VAP Platinum Packages

Automatic distillations with Hei-VAP Precision hand lift models and valve-regulated vacuum pumps

#### Hei-VAP Platinum 1 Package

P/N 563-61300-00

- Hei-VAP Precision with hand lift and vertical glassware set G3
- Vapor temperature sensor
- Vacuum valve
- Vacuum pump Rotavac Valve Tec with condenser
- Tube set

#### Hei-VAP Platinum 2 Package

P/N 563-51310-00

- Hei-VAP Precision with hand lift and coated vertical glassware set G3B
- AUTOaccurate-sensor
- Vacuum valve
- Vacuum pump Rotavac Valve Control with condenser
- Tube set

### Hei-VAP Safety Upgrade

For highest safety

#### Hei-VAP Safety Upgrade

P/N 569-00311-00

Additional guard hood and coating of glassware for your Hei-VAP Package



### Hei-VAP Platinum Packages

Automatic distillations with Hei-VAP Precision motor lift models and RPM-regulated vacuum pumps

#### Hei-VAP Platinum 3 Package

P/N 564-21300-00

- Hei-VAP Precision with motor lift and vertical glassware set G3
- AUTOaccurate-sensor
- Vacuum pump Rotavac Vario Tec with condenser
- Woulff bottle
- Tube set

#### Hei-VAP Platinum 4 Package

P/N 564-31310-00

- Hei-VAP Precision with motor lift and coated vertical glassware set G3B
- AUTOaccurate-sensor
- Vacuum pump Rotavac Vario Control with condenser
- Woulff bottle
- Tube set

#### Hei-VAP Platinum 5 Package

P/N 564-31318-00

- Hei-VAP Precision with motor lift and coated vertical glassware set G3B
- AUTOaccurate-sensor
- Vacuum pump Rotavac Vario Control with condenser
- Woulff bottle
- Chiller RotaChill Large
- Tube set

## Technical Specifications - Rotary Evaporators

Model	Hei-VAP Value (HL) / Value Digital (HL)	Hei-VAP Advantage (HL)	Hei-VAP Advantage (ML)	Hei-VAP Precision (HL)	Hei-VAP Precision (ML)
Hand / Motor lift	hand lift	hand lift	motor lift	hand lift	motor lift
Height adjustment speed	manual	manual	30 mm/s	manual	30 mm/s
Height adjustment (mm)	155	155	155	155	155
Rotation speed (rpm)	10 – 280	10 – 280	10 – 280	10 – 280	10 – 280
Rotation speed setting	scale	3.5" LCD display	3.5" LCD display	4.3" LCD color graphic display	4.3" LCD color graphic display
Drive		brushless DC motor with electronic speed control			
Heating capacity (W)	1,300	1,300	1,300	1,300	1,300
Temp. range heating bath (°C)	20 – 210	20 – 210	20 – 210	20 – 210	20 – 210
Temperature accuracy bath (°C)	±1	±1	±1	±1	±1
Overheat protection bath (°C)		cut-off at 5 °C over set temperature via separate Pt 1000			
Bath temperature setting****	scale / digital	3.5" LCD display	3.5" LCD display	4.3" LCD color graphic display	4.3" LCD color graphic display
Heating bath temperature control	electronic / digital	electronic / digital	electronic / digital	electronic / digital	electronic / digital
Secondary overtemp. cut-off (°C)	250	250	250	250	250
Material heating bath	stainless steel AISI 316L	stainless steel AISI 316L	stainless steel AISI 316L	stainless steel AISI 316L	stainless steel AISI 316L
Diameter heating bath (mm)	255	255	255	255	255
Volume heating bath (L)	4.5	4.5	4.5	4.5	4.5
Display vapor temperature required accessories	no	yes vapor temperature sensor	yes vapor temperature sensor	yes vapor temperature sensor	yes vapor temperature sensor
Integrated vacuum controller	no	no	no	yes	yes
Timer	no	yes	yes	yes	yes
Vacuum program SET <sup>pressure</sup> **	no	no	no	yes	yes
Vacuum program AUTO <sup>easy</sup> **	no	no	no	yes	yes
Vacuum program AUTO <sup>accurate</sup> ** requires AUTO <sup>accurate</sup> -sensor	no	no	no	yes	yes
Remote control function					
- Lift	no	no	yes	no	yes
- Start rotation	yes	yes	yes	yes	yes
- Start vacuum	no	no	no	yes	yes
- Start heating bath	yes	yes	yes	yes	yes
Programmable ramps	no	no	no	yes	yes
Supply power (W)	1,400	1,400	1,400	1,400	1,400
Weight (w/o glassware assembly) (kg)	16	16	16	17	17
Dimensions with glassware set G3 (l x w x h) (mm)	739 x 490 x 887	739 x 490 x 887	739 x 420 x 887	739 x 490 x 887	739 x 420 x 887
Protection class*** (DIN EN 60529)	IP 20	IP 20	IP 20	IP 20	IP 20
Operating conditions (°C)	0 - 40 at 80 % rel. humidity	0 - 40 at 80 % rel. humidity	0 - 40 at 80 % rel. humidity	0 - 40 at 80 % rel. humidity	0 - 40 at 80 % rel. humidity
Rate of evaporation* (L/h)					
- Toluene	8.5	8.5	8.5	8.5	8.5
- Acetone	5.8	5.8	5.8	5.8	5.8
- Ethanol	3.5	3.5	3.5	3.5	3.5
- Water	1.2	1.2	1.2	1.2	1.2
Condensing surface (cm <sup>2</sup> )	1,200	1,200	1,200	1,200	1,200

\* ΔT of 40 °C between heating bath temperature and boiling temperature  
 \*\* Only in combination with vacuum systems  
 \*\*\* IP 67 cable connection on heating bath  
 \*\*\*\* Hei-VAP Value Digital: digital display

Standard supply voltage: 230 V - other voltages upon request, please specify for order

# Certificate

To confirm the ability for  
continuous operation  
of the Hei-VAP series Rotary Evaporators

Hei-VAP series Rotary Evaporators feature overtemperature safety circuits according to DIN EN 61010-1:2001 and DIN EN 61010-2-010:2003 and therefore is designed for continuous operation.

This statement is made under the precondition that all units are operated in accordance with the operation manual and in accordance with good practice standards for safety in laboratories, rules for accident preventions, and compliance with directions on hazardous materials.

Schwabach, January 2016

  
Stefan Peters  
Research and Development Manager

  
Marcell Sarré  
Quality Manager



**Heidolph Instruments GmbH & Co. KG**

Walpersdorfer Str. 12 • 91126 Schwabach/Germany

Phone +49 9122/9920-19 • Fax +49 9122/9920-65

Carina.Wagner@heidolph.de • www.heidolph.com

 **heidolph**  
research made easy