

1 2 3 4 5 6 7 8

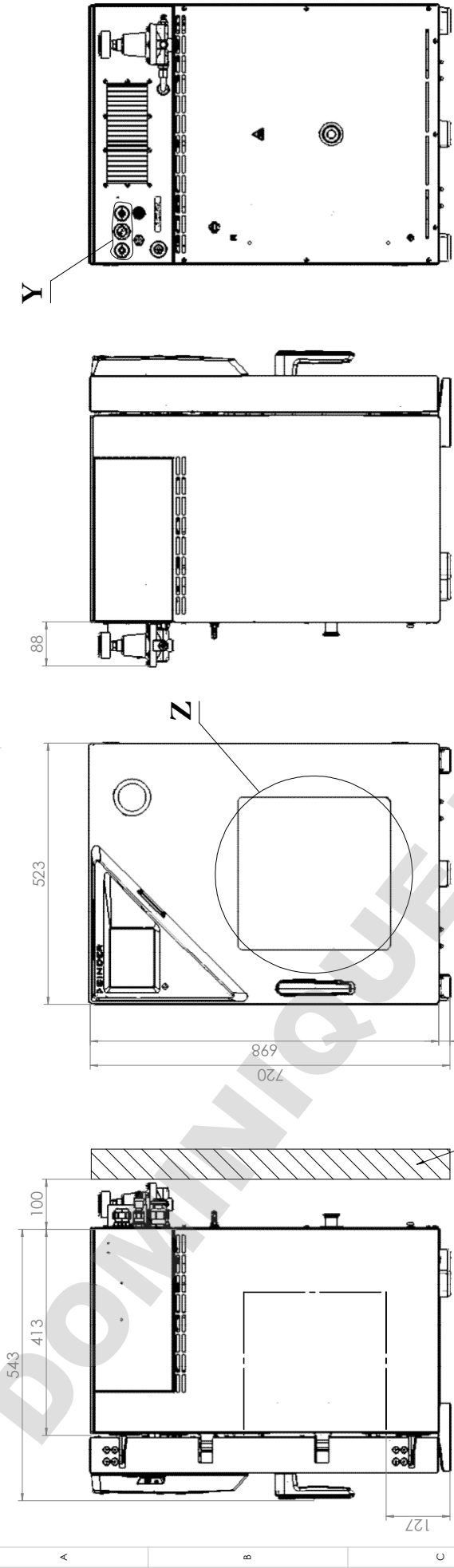

Wand wall

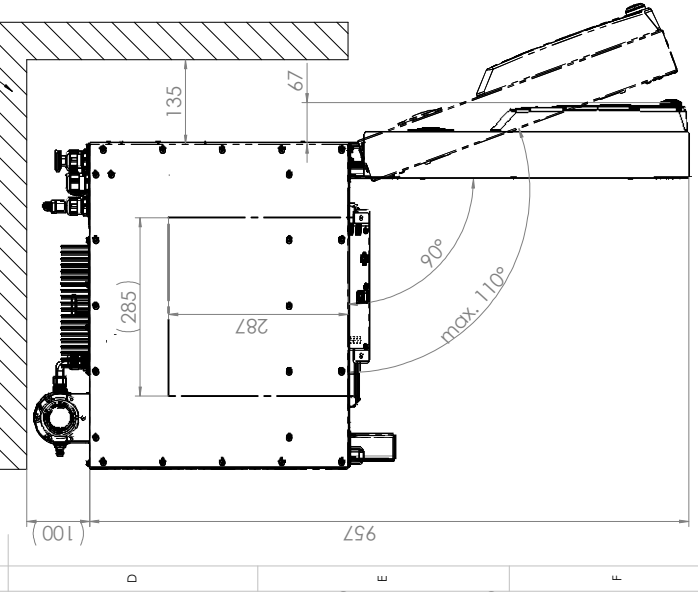

Z
1:4
Ansicht ohne Tür
view without door

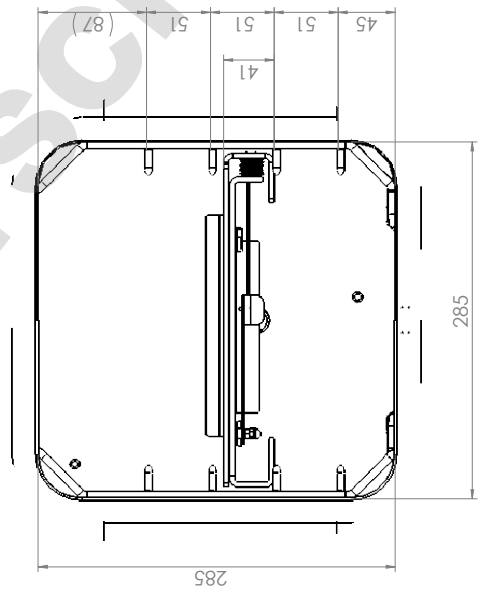

Y
1:2
Netzanschluss
power connection

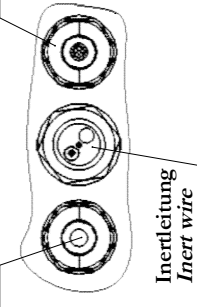

Y
1:15
Innenkessel
inner chamber

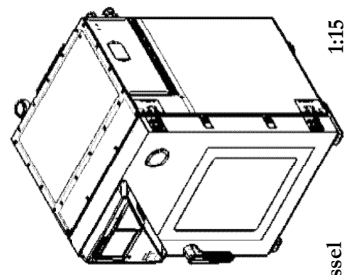

BINDER
Im Mittleren Ösch 5
78532 Tuttingen
Germany 9033-030

Benennung: VDL 023
Title:
Bezeichnung: (230V) (E3)
Description:
Zeichnungsnummer:
Drawing number: 9630-0009

Maßstab:
Scale: 1:8
Messenheit:
measuring unit: mm
DIN A3
Blatt 1 von 2

ISO 2768-mk

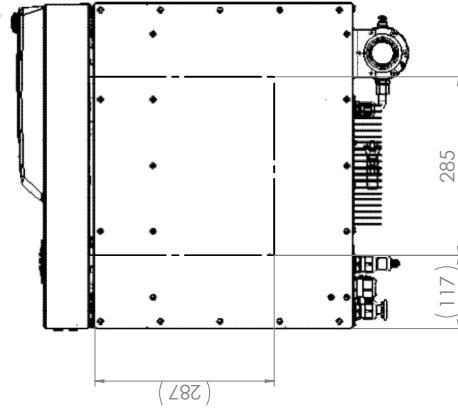
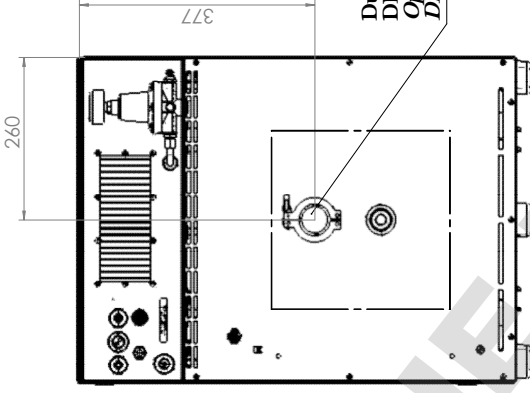
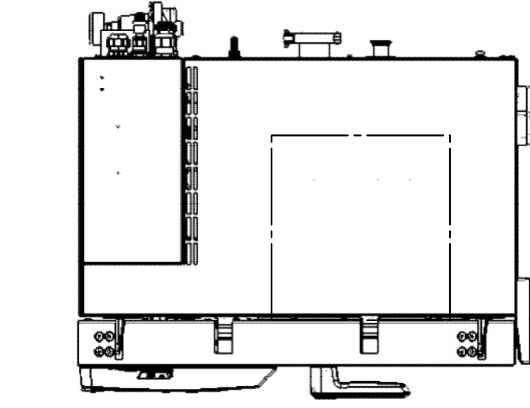

Innenkessel
inner chamber

BINDER Im Mittleren Ösch 5
78532 Tuttingen
ISO 9001:2008

Benennung: VDL 023
Title:

Bezeichnung: (230V) (E3)
Description:

Zeichnungsnummer: 9630-0009
Drawing number:

Maßstab: 1:8
Scale

Maßeinheit: mm
measuring unit

ISO 2768-mk
General tolerance

DIN A3
Blatt 2 von 2