

Operating Manual

Translation of the original operating manual

VD (E3.1) Vacuum Drying Oven

Standard: with RD4 microprocessor program controller

Optional: with MB2 microprocessor program controller

Model	Model version	Art. No.
VD 23	VD023-230V	9630-0001
VD 23-UL	VD023UL-120V	9630-0005
VD 56	VD056-230V	9630-0002
VD 56-UL	VD056UL-120V	9630-0006
VD 115	VD115-230V	9630-0003
VD 115-UL	VD115UL-120V	9630-0007

BINDER GmbH

- ▶ Address: Post office box 102, 78502 Tuttlingen, Germany ▶ Phone: +49 7462 2005 0
- ▶ Fax: +49 7462 2005 100 ▶ Internet: <http://www.binder-world.com>
- ▶ E-mail: info@binder-world.com ▶ Service Hotline: +49 7462 2005 555
- ▶ Service Fax: +49 7462 2005 93 555 ▶ Service E-Mail: service@binder-world.com
- ▶ Service Hotline USA: +1 866 885 9794 or +1 631 224 4340 x3
- ▶ Service Hotline Asia Pacific: +852 390 705 04 or +852 390 705 03
- ▶ Service Hotline Russia and CIS: +7 495 988 15 16

Contents

1. SAFETY	8
1.1 Personnel Qualification	8
1.2 Operating manual.....	8
1.3 Legal considerations	8
1.4 Structure of the safety instructions.....	9
1.4.1 Signal word panel	9
1.4.2 Safety alert symbol	9
1.4.3 Pictograms	10
1.4.4 Word message panel structure.....	10
1.5 Localization / position of safety labels on the chamber	11
1.6 Type plate.....	11
1.7 General safety instructions on installing and operating the chamber	12
1.8 Intended use	14
1.9 Foreseeable Misuse	15
1.10 Residual Risks	16
1.11 Operating instructions	17
1.12 Measures to prevent accidents	17
2. DESCRIPTION OF THE EQUIPMENT	19
2.1 Chamber overview	20
2.2 Instrument panel with regular RD4 controller.....	21
2.3 Instrument panel with optional MB2 controller.....	21
2.4 Connections on the rear of the chamber.....	21
3. COMPLETENESS OF DELIVERY, TRANSPORTATION, STORAGE, AND INSTALLATION	23
3.1 Unpacking, and checking equipment and completeness of delivery	23
3.2 Guidelines for safe lifting and transportation.....	24
3.3 Storage.....	24
3.4 Location of installation and ambient conditions	24
4. INSTALLATION AND CONNECTIONS	26
4.1 Vacuum expansion racks and rack holders	26
4.2 Mounting the tilt protection holders	27
4.3 Pump module (option).....	28
4.3.1 Pump module without pump (option).....	29
4.3.2 Pump module with pump stand (option)	29
4.4 Vacuum connection.....	31
4.4.1 VD connection kit for VAP1-VAP2 (option).....	31
4.5 Connecting inert gas supply.....	32
4.6 Electrical connection	33
5. FUNCTIONAL OVERVIEW AND MENU STRUCTURE OF THE CONTROLLER	34
5.1 RD4 controller	34
5.1.1 Menu structure of the controller and access levels	35
5.2 MB2 controller	36
5.2.1 Operating functions in normal display.....	37
5.2.2 Display views: Normal display, program display, chart-recorder display	38
5.2.3 MB2 controller icons overview.....	39
5.2.4 MB2 controller operating modes.....	41
5.2.5 MB2 controller menu structure.....	41
5.2.5.1 Main menu	42
5.2.5.2 "Settings" submenu	43
5.2.5.3 "Service" submenu	43
5.2.6 Principle of controller entries	44

5.3	Performance during and after power failures	44
5.3.1	RD4 controller	44
5.3.2	MB2 controller	45
6.	START UP	45
6.1	Condition after establishing the power connection	45
6.2	Standby mode: Turning on and off the vacuum drying oven	46
6.2.1	RD4 controller	46
6.2.2	MB2 controller	47
6.3	Controller settings upon start up	48
6.3.1	RD4 controller	48
6.3.2	MB2 controller	48
6.4	Vacuum system	49
6.4.1	Evacuation	49
6.4.2	Ventilation after completing the drying procedure (flooding with ambient air or inert gas)	50
6.4.3	Ventilation / breaking the vacuum in case of a power failure	50
6.4.4	Operation with inert gas	50
7.	SET-POINT ENTRY	51
7.1	RD4 controller	51
7.1.1	Temperature set-point entry	51
7.1.2	Pressure set-point entry	52
7.2	MB2 controller	52
7.2.1	Set-point entry through the "Setpoints" menu	52
7.2.2	Direct setpoint entry via Normal display	53
8.	SETTING SPECIAL CONTROLLER FUNCTIONS	54
8.1	Menu structure	54
8.1.1	RD4 controller	54
8.1.1.1	"Functions on/off" menu	54
8.1.1.2	Quick Access menu	55
8.1.2	MB2 controller	55
8.1.2.1	"Functions on/off" menu	55
8.1.2.2	"Control on/off" menu	57
8.2	Turning off the vacuum pump via the socket on the pump module	57
8.2.1	RD4 controller	57
8.2.2	MB2 controller	58
8.3	Using the optional universal connection "GAS/AIR 2" for ventilation	58
8.3.1	RD4 controller	59
8.3.2	MB2 controller	59
8.4	Close all valves	60
8.4.1	RD4 controller	60
8.4.2	MB2 controller	60
8.5	Activating / deactivating temperature control	61
8.5.1	RD4 controller	61
8.5.2	MB2 controller	61
8.6	Activating / deactivating pressure control	62
8.6.1	RD4 controller	62
8.6.2	MB2 controller	63
8.7	Drying monitoring	64
8.7.1	RD4 controller	65
8.7.2	MB2 controller	65
9.	AUTHORIZATION LEVELS AND PASSWORD PROTECTION	66
9.1	RD4 controller	66
9.1.1	Password request	66
9.1.2	Assign and modify a password	66
9.1.2.1	Assign and modify the User password	66
9.1.2.2	Assign and modify the Admin password	67

9.2	MB2 controller	68
9.2.1	User management, authorization levels and password protection	68
9.2.2	Log in	71
9.2.3	Log out	72
9.2.4	User change	72
9.2.5	Password assignment and password change	73
9.2.5.1	Password change	73
9.2.5.2	Deleting the password for an individual authorization level	75
9.2.5.3	New password assignment for "service" or "admin" authorization level when the password function was deactivated	76
9.2.6	Activation code	77
10.	GENERAL CONTROLLER SETTINGS AND INFORMATION	78
10.1	RD4 controller	78
10.1.1	Selecting the controller's menu language	78
10.1.2	Selecting the temperature unit	78
10.1.3	Setting the current date	79
10.1.4	Setting the current time	80
10.1.5	Function "Language selection at restart"	80
10.1.6	Setting the chamber address	81
10.1.7	Display brightness	81
10.1.8	Display of the inner chamber temperature and the heating temperature	81
10.2	MB2 controller	82
10.2.1	Selecting the controller's menu language	82
10.2.2	Setting date and time	82
10.2.3	Selecting the temperature unit	84
10.2.4	Display configuration	84
10.2.4.1	Adapting the display parameters	84
10.2.4.2	Touchscreen calibration	85
10.2.5	Event list	86
10.2.6	Service contact page	86
10.2.7	Current operating parameters	87
10.2.8	Technical chamber information	87
11.	TEMPERATURE SAFETY DEVICES	88
11.1	Over temperature protective device class 2 (thermal switch)	88
11.2	Overtemperature safety controller class 2	88
11.2.1	Safety controller mode	88
11.2.2	Setting the safety controller	89
11.2.2.1	RD4 controller: Setting the safety controller mode	89
11.2.2.2	RD4 controller: Setting the safety controller value	89
11.2.2.3	MB2 controller	90
11.2.3	Message and measures in the state of alarm	91
11.2.3.1	RD4 controller	91
11.2.3.2	MB2 controller	91
11.2.4	Function check	92
12.	TOLERANCE RANGE SETTINGS	92
12.1	RD4 controller	92
12.1.1	Setting the delay time for temperature tolerance range alarm	92
12.1.2	Setting the temperature tolerance range	92
12.1.3	Setting the delay time for pressure tolerance range alarm	93
12.1.4	Setting the pressure tolerance range	93
12.1.5	State of alarm	93
12.2	MB2 controller	94
12.2.1	Setting the alarm delay times and the tolerance ranges	94
12.2.2	Alarm condition	94

13. NOTIFICATION AND ALARM FUNCTIONS	95
13.1 Information messages	95
13.1.1 RD4 controller	95
13.1.2 MB2 controller	96
13.2 Alarm messages	97
13.2.1 RD4 controller	97
13.2.2 MB2 controller	98
13.3 Resetting an alarm	99
13.3.1 RD4 controller	99
13.3.2 MB2 controller	99
13.4 Activating / deactivating the audible alarm (buzzer)	100
13.4.1 RD4 controller	100
13.4.2 MB2 controller	100
14. RD4 CONTROLLER: PROGRAM START / STOP FUNCTION	101
14.1 Start time program	101
14.2 Start week program	101
14.3 Stop program	102
15. MB2 CONTROLLER: TIMER PROGRAM (STOPWATCH FUNCTION).....	103
15.1 Starting a timer program	103
15.1.1 Performance during program delay time	103
15.2 Stopping a running timer program	104
15.2.1 Pausing a running timer program	104
15.2.2 Cancelling a running timer program	104
15.3 Performance after the end of the program	104
16. MB2 CONTROLLER: TIME PROGRAMS	105
16.1 Starting an existing time program	105
16.1.1 Performance during program delay time	106
16.2 Stopping a running time program	106
16.2.1 Pausing a running time program	106
16.2.2 Cancelling a running time program	106
16.3 Performance after the end of the program	106
16.4 Creating a new time program	107
16.5 Program editor: program management	107
16.5.1 Deleting a time program	108
16.6 Section editor: section management	109
16.6.1 Add a new program section	110
16.6.2 Copy and insert or replace a program section	110
16.6.3 Deleting a program section	111
16.7 Value entry for a program section	112
16.7.1 Section duration	112
16.7.2 Set-point ramp and set-point step	113
16.7.3 Special controller functions	114
16.7.4 Setpoint entry	115
16.7.5 Tolerance range	115
16.7.6 Repeating one or several sections within a time program	116
16.7.7 Saving the time program	117
17. MB2 CONTROLLER: WEEK PROGRAMS.....	118
17.1 Starting an existing week program	118
17.2 Cancelling a running week program	118
17.3 Creating a new week program	119
17.4 Program editor: program management	120
17.4.1 Deleting a week program	121
17.5 Section editor: section management	122
17.5.1 Add a new program section	123

17.5.2	Copy and insert or replace a program section	123
17.5.3	Deleting a program section	124
17.6	Value entry for a program section in the Section view	124
17.6.1	Set-point ramp and set-point step modes	124
17.6.2	Weekday	125
17.6.3	Start time	125
17.6.4	Setpoint entry	125
17.6.5	Special controller functions	126
18.	NETWORK AND COMMUNICATION	126
18.1	RD4 controller: Ethernet network settings	126
18.1.1	Showing the network settings	126
18.1.1.1	Showing the chamber's MAC address	126
18.1.1.2	Showing the IP address	127
18.1.1.3	Showing the subnet mask	127
18.1.1.4	Showing the standard gateway	127
18.1.1.5	Showing the DNS server address	128
18.1.1.6	Showing the DNS chamber name	128
18.1.2	Changing the configuration of the network settings	128
18.1.2.1	Selecting the type of IP address assignment (automatic / manual)	129
18.1.2.2	Selecting the type of assignment of the DNS server address (automatic / manual)	129
18.1.2.3	Assigning the IP address	129
18.1.2.4	Setting the subnet mask	130
18.1.2.5	Setting the standard gateway	131
18.1.2.6	Assigning the DNS server address	131
18.2	MB2 controller	132
18.2.1	Ethernet	132
18.2.1.1	Configuration	132
18.2.1.2	Display of MAC address	133
18.2.2	Web server	133
18.2.3	E-Mail	134
19.	RD4 CONTROLLER: DATA RECORDER	135
19.1	Recorded data	135
19.2	Storage capacity	135
19.3	Setting the storage rate for the "DL1" recorder data	136
19.4	Deleting the data recorder	136
20.	USB MENU: DATA TRANSFER VIA USB INTERFACE	136
20.1	RD4 controller	136
20.1.1	Connecting the USB stick	137
20.1.2	Import function	137
20.1.3	Export functions	137
20.1.4	Ongoing data transfer	138
20.1.5	Error during data transmission	138
20.1.6	Removing the USB stick	138
20.2	MB2 controller	138
21.	MB2 CONTROLLER: CHART RECORDER DISPLAY	140
21.1	Views	140
21.1.1	Show and hide legend	140
21.1.2	History display	140
21.2	Setting the parameters	143
22.	REFERENCE MEASUREMENTS	144
22.1	Checking the temperature in the inner chamber	144
22.1.1	Checking the controller display	144
22.1.2	Checking the spatial temperature exactitude	144

23. OPTIONS	145
23.1 APT-COM™ 4 Multi Management software (Option)	145
23.2 Analog outputs for temperature and pressure (option)	145
23.3 Measuring access port for vacuum, 9 poles (option)	145
23.4 Object temperature display with flexible Pt 100 temperature sensor (option)	146
23.4.1 Connection of the object temperature sensor	146
23.4.2 Display on the RD4 controller	147
23.4.3 Display on the MB2 controller	147
23.5 LED interior lighting	147
24. CLEANING AND DECONTAMINATION	148
24.1 Cleaning	148
24.2 Decontamination / chemical disinfection	149
25. MAINTENANCE AND SERVICE, TROUBLESHOOTING, REPAIR, TESTING.	151
25.1 General information, personnel qualification	151
25.2 Simple troubleshooting	151
25.3 Maintenance intervals, service	154
25.4 Service Reminder	154
25.4.1 RD4 controller	154
25.4.2 MB2 controller	155
25.5 Sending the chamber back to BINDER GmbH	155
26. DISPOSAL	156
26.1 Disposal of the transport packing	156
26.2 Decommissioning	156
26.3 Disposal of the chamber in the Federal Republic of Germany	157
26.4 Disposal of the chamber in the member states of the EU except for the Federal Republic of Germany.....	158
26.5 Disposal of the chamber in non-member states of the EU	159
27. TECHNICAL DESCRIPTION	160
27.1 Factory calibration and adjustment	160
27.2 Over current protection	160
27.3 VD / VD-UL technical data	160
27.4 Equipment and options (extract)	162
27.5 Accessories and spare parts (extract)	163
27.6 Dimensions.....	165
27.6.1 VD 23	165
27.6.2 VD 56	166
27.6.3 VD 115	167
28. CERTIFICATES AND DECLARATIONS OF CONFORMITY	168
28.1 EU Declaration of Conformity.....	168
29. PRODUCT REGISTRATION	171
30. CONTAMINATION CLEARANCE CERTIFICATE	172
30.1 For chambers located outside USA and Canada	172
30.2 For chambers located in USA and Canada	175

Dear customer,

For the correct operation of the chamber, it is important that you read this operating manual completely and carefully and observe all instructions as indicated. Failure to read, understand and follow the instructions may result in personal injury. It can also lead to damage to the chamber and/or poor equipment performance.

1. Safety

1.1 Personnel Qualification



The chamber must only be installed, tested, and started up by personnel qualified for assembly, startup, and operation of the chamber. Qualified personnel are persons whose professional education, knowledge, experience and knowledge of relevant standards allow them to assess, carry out, and identify any potential hazards in the work assigned to them. They must have been trained and instructed, and be authorized, to work on the chamber.

The chamber should only be operated by laboratory personnel especially trained for this purpose and familiar with all precautionary measures required for working in a laboratory. Observe the national regulations on minimum age of laboratory personnel.

1.2 Operating manual

This operating manual is part of the components of delivery. Always keep it handy for reference in the vicinity of the chamber. If selling the unit, hand over the operating manual to the purchaser.

To avoid injuries and damage observe the safety instructions of the operating manual. Failure to follow instructions and safety precautions can lead to significant risks.

	 DANGER
<p>Dangers due to failure to observe the instructions and safety precautions. Serious injuries and chamber damage. Risk of death.</p> <ul style="list-style-type: none"> ➤ Observe the safety instructions in this Operating Manual. ➤ Follow the operating procedures in this Operating Manual. ➤ Carefully read the complete operating instructions of the chamber prior to installing and using the chamber. ➤ Keep the operating manual for future reference 	

	<p>Make sure that all persons who use the chamber and its associated work equipment have read and understood the Operating Manual.</p>
---	--

This Operating Manual is supplemented and updated as needed. Always use the most recent version of the Operating Manual. When in doubt, call the BINDER Service Hotline for information on the up-to-dateness and validity of this Operating Manual.

1.3 Legal considerations

This operating manual is for informational purposes only. It contains information for correct and safe installing, start-up, operation, decommissioning, cleaning and maintenance of the product. Note: the contents and the product described are subject to change without notice.

Understanding and observing the instructions in this operating manual are prerequisites for hazard-free use and safety during operation and maintenance. Images are to provide basic understanding. They may deviate from the actual version of the chamber. The actual scope of delivery can, due to optional or special design, or due to recent technical changes, deviate from the information and illustrations in these instructions this operating manual. In no event shall BINDER be held liable for any damages, direct or incidental arising out of or related to the use of this manual.

This operating manual cannot cover all conceivable applications. If you would like additional information, or if special problems arise that are not sufficiently addressed in this manual, please ask your dealer or contact us directly by phone at the number located on page one of this manual

Furthermore, we emphasize that the contents of this operating manual are not part of an earlier or existing agreement, description, or legal relationship, nor do they modify such a relationship. All obligations on the part of BINDER derive from the respective purchase contract, which also contains the entire and exclusively valid statement of warranty administration and the general terms and conditions, as well as the legal regulations valid at the time the contract is concluded. The statements in this manual neither augment nor restrict the contractual warranty provisions.

1.4 Structure of the safety instructions

In this operating manual, the following safety definitions and symbols indicate dangerous situations following the harmonization of ISO 3864-2 and ANSI Z535.6.

1.4.1 Signal word panel

Depending on the probability of serious consequences, potential dangers are identified with a signal word, the corresponding safety color, and if appropriate, the safety alert symbol.

 DANGER
Indicates an imminently hazardous situation that, if not avoided, will result in death or serious (irreversible) injury.

 WARNING
Indicates a potentially hazardous situation which, if not avoided, could result in death or serious (irreversible) injury.

 CAUTION
Indicates a potentially hazardous situation which, if not avoided, may result in moderate or minor (reversible) injury.

NOTICE
Indicates a potentially hazardous situation which, if not avoided, may result in damage to the product and/or its functions or of a property in its proximity.





















1.4.2 Safety alert symbol



Use of the safety alert symbol indicates a **risk of injury**.

Observe all measures that are marked with the safety alert symbol in order to avoid death or injury.

1.4.3 Pictograms

Warning signs			
 Electrical hazard	 Hot surface	 Explosive atmosphere	 Stability hazard
 Lifting hazard	 Inhalation hazard	 Suffocation hazard	 Harmful substances
 Biohazard	 Risk of corrosion and / or chemical burns	 Pollution Hazard	
Mandatory action signs			
 Mandatory regulation	 Read operating instructions	 Disconnect the power plug	 Lift with several persons
 Environment protection	 Wear protective gloves	 Wear safety goggles	
Prohibition signs			
 Do NOT touch	 Do NOT spray with water		

	Information to be observed in order to ensure optimum function of the product.
---	---

1.4.4 Word message panel structure

<p>Type / cause of hazard.</p> <p>Possible consequences.</p> <ul style="list-style-type: none"> ⊘ Instruction how to avoid the hazard: prohibition ➤ Instruction how to avoid the hazard: mandatory action
--

Observe all other notes and information not necessarily emphasized in the same way, in order to avoid disruptions that could result in direct or indirect injury or property damage.

1.5 Localization / position of safety labels on the chamber

The following labels are located on the chamber:

Pictograms (Warning signs)	
	Hot surface (on the outer chamber door)
Service label	
<div style="background-color: red; color: white; padding: 5px;"> Service - Hotline International: + 49 (0) 7462 / 2005-555 USA Toll Free: + 1 866 885 9794 or: + 1 631 224 4340 Россия и СНГ: + 7 495 98815 17 service@binder-world.com www.binder-world.com </div>	

	Keep safety labels complete and legible.
---	--

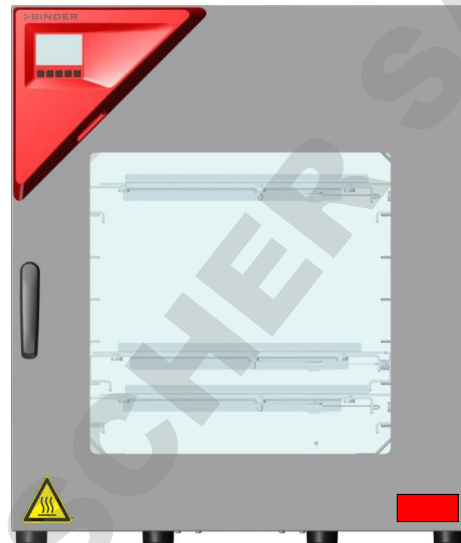

Figure 1: Position of labels on the chamber (example: regular chamber with RD4 controller)

1.6 Type plate



The type plate sticks to the left side of the chamber, bottom right-hand.

Nominal temp.	220 °C 428 °F	1,60 kW / 7,0 A 230 V / 50 Hz		
IP protection	20	230 V / 60 Hz		
Safety device	DIN 12880	1 N ~		
Class	2.0			
Art. No.	9630-0003			
Project No.		Vacuum Drying Oven		
Built	2020			
		BINDER GmbH Im Mittleren Ösch 5 78532 Tuttlingen / Germany www.binder-world.com	VD 115 E3.1	Serial No. 0000000000000 Made in Germany

Figure 2: Type plate (example of VD 115)

Indications of the type plate (example)		Information
BINDER		Manufacturer: BINDER GmbH
VD 115		Model designation
Vacuum Drying Oven		Device name
Serial No.	000000000000	Serial no. of the chamber
Built	2020	Year of construction
Nominal temperature	220 °C 428 °F	Nominal temperature
IP protection	20	IP type of protection acc. to standard EN 60529

Indications of the type plate (example)		Information
Temp. safety device	DIN 12880	Temperature safety device acc. to standard DIN 12880:2007
Class	2.0	Class of temperature safety device
Art. No.	9630-0003	Art. no. of the chamber
Project No.	---	Optional: Special application acc. to project no.
1,60 kW		Nominal power
7,0 A		Nominal current
230 V / 50 Hz		Nominal voltage +/- 10% at the indicated power frequency
230 V / 60 Hz		
1 N ~		Current type

Symbol on the type plate	Information
	CE conformity marking
	Electrical and electronic equipment manufactured / placed on the market in the EC after 13 August 2005 and to be disposed of in a separate collection according to Directive 2012/19/EU on waste electrical and electronic equipment (WEEE).

1.7 General safety instructions on installing and operating the chamber



With regard to operating the chamber and to the installation location, please observe the DGUV guidelines 213-850 on safe working in laboratories, issued by the employers' liability insurance association (for Germany).

BINDER GmbH is only responsible for the safety features of the chamber provided skilled electricians or qualified personnel authorized by BINDER perform all maintenance and repair, and if components relating to chamber safety are replaced in the event of failure with original spare parts.



To operate the chamber, use only original BINDER accessories or accessories from third-party suppliers authorized by BINDER. The user is responsible for any risk caused by using unauthorized accessories.

NOTICE	
	<p>Danger of overheating due to lack of ventilation. Damage to the chamber.</p> <ul style="list-style-type: none"> ⊘ Do NOT install the chamber in unventilated recesses. ➤ Ensure sufficient ventilation for dispersal of the heat. ➤ Observe the prescribed minimum distances when installing the chamber (chap. 3.4)

Do not install or operate the vacuum drying oven VD in potentially explosive areas.

 DANGER	
	<p>Danger of explosion due to combustible dusts or explosive mixtures in the vicinity of the equipment. Serious injury or death from burns and / or explosion pressure.</p> <ul style="list-style-type: none"> ➤ Do NOT operate the equipment in potentially explosive areas. ➤ KEEP combustible dust or air-solvent mixtures AWAY from the equipment.

The chamber does not dispose of any measures of explosion protection.

	 DANGER
	<p>Danger of explosion due to introduction of flammable or explosive substances in the chamber.</p> <p>Serious injury or death from burns and / or explosion pressure.</p> <ul style="list-style-type: none"> ⊘ Do NOT introduce any substance into the chamber which is combustible or explosive at working temperature. ⊘ Do NOT introduce any combustible dust or air-solvent mixture in the inner chamber. ⊘ Do NOT use the vacuum drying oven for drying or heat treatments leading to release of combustible vapors able to form an explosive mixture with air.



Any solvent contained in the charging material must not be explosive or inflammable. I.e., irrespective of the solvent concentration in the steam room, NO explosive mixture with air must form. The drying temperature must lie below the flash point or below the sublimation point of the charging material. Familiarize yourself with the physical and chemical properties of the charging material, as well as the contained moisture constituent and its behavior with the addition of heat energy and changes in pressure.

Familiarize yourself with any potential health risks caused by the charging material, the contained moisture constituent or by reaction products that may arise during the drying process. Take adequate measures to exclude such risks prior to putting the chamber into operation.

	 DANGER
	<p>Electrical hazard by water entering the chamber.</p> <p>Deadly electric shock.</p> <ul style="list-style-type: none"> ⊘ The chamber must NOT become wet during operation, cleaning, or maintenance. ⊘ Do NOT install the chamber in damp areas or in puddles. ➤ Set up the chamber in a splash-proof manner.

The chambers were produced in accordance with the relevant VDE regulations and were routinely tested in accordance to VDE 0411-1 (IEC 61010-1).

During and shortly after operation, the temperature of the inner surfaces almost equals the set-point. The inner chamber will become hot during operation.

	 CAUTION
	<p>Danger of burning when touching the inner surfaces during operation.</p> <p>Burns.</p> <ul style="list-style-type: none"> ⊘ Do NOT touch the inner surfaces or the charging material during and after operation.

In the case of operation with inert gas, the chamber is supplied with an oxygen-displacing gas (e.g. N₂). The gas emerging from the system must therefore be removed from the installation area by means of a suitable extraction system (see technical ventilation measures in the DGUV guidelines 213-850 on safe working in laboratories, issued by the employers' liability insurance association (for Germany).

	<p>With use of a vacuum system or a vacuum pump, observe the permitted gas inlet temperature. Observe the safety instructions of the pump manufacturer.</p>
---	---

1.8 Intended use

	Observing the instructions in this operating manual and conducting regular maintenance work (chap. 24) is part of the intended use.
---	---

Any use of the chambers that does not comply with the requirements specified in this Operating Manual shall be considered improper use.

Other applications than those described in this chapter are not approved.

Use



The VD vacuum drying ovens are suitable for drying and heat treatment of solid or pulverized charging material, as well as bulk material, using the supply of heat under vacuum.

Requirements for the chamber load



Any solvent content must not be explosive or flammable. A mixture of any component of the charging material with air must NOT be explosive. The drying temperature must lie below the flash point or below the sublimation point of the charging material. Any component of the charging material must NOT be able to release toxic gases.

The loading material shall not contain any corrosive ingredients that may damage the machine components made of stainless steel and aluminum. Such ingredients include in particular acids and halides. Any corrosive damage caused by such ingredients is excluded from liability by BINDER GmbH.

The chamber does not dispose of any measures of explosion protection.

 	<div style="background-color: red; color: white; padding: 5px; text-align: center;">  DANGER </div> <p>Explosion or implosion hazard and danger of poisoning through the introduction of unsuitable loading material.</p> <p>Poisoning. Serious injury or death from burns and / or explosion pressure.</p> <ul style="list-style-type: none"> ⊘ Do NOT introduce any substance combustible or explosive at working temperature into the chamber, in particular no energy sources such as batteries or lithium-ion batteries. ⊘ Do NOT introduce explosive dust or air-solvent mixture into the inner chamber. ⊘ Do NOT introduce any substance which could lead to release of toxic gases.
---	--

Contamination of the chamber by toxic, infectious or radioactive substances must be prevented

 	<div style="background-color: orange; color: black; padding: 5px; text-align: center;">  WARNING </div> <p>Danger of intoxication and infection through contamination of the chamber with toxic, infectious or radioactive substances.</p> <p>Damages to health.</p> <ul style="list-style-type: none"> ➤ Protect the interior of the chamber from contamination by toxic, infectious or radioactive substances. ➤ Take suitable protective measures when introducing and removing toxic, infectious or radioactive material
--	--

In case of foreseeable use of the chamber there is no risk for the user through the integration of the chamber into systems or by special environmental or operating conditions in the sense of EN 61010-1:2010. For this, the intended use of the chamber and all its connections must be observed.

Medical devices

The chambers are not classified as medical devices as defined by the Medical Device Directive 93/42/EEC.



Due to the special demands of the Medical Device Directive (MDD), these chambers are not qualified for sterilization of medical devices as defined by the directive 93/42/EEC.

Personnel Requirements

Only trained personnel with knowledge of the Operating Manual can set up and install the chamber, start it up, operate, clean, and take it out of operation. Service and repairs call for further technical requirements (e.g. electrical know-how), as well as knowledge of the service manual.

Installation site requirements

The chambers are designed for setting up inside a building (indoor use).

The requirements described in the Operating Manual for installation site and ambient conditions (Chap. 3.4) must be met.

1.9 Foreseeable Misuse

Other applications than those described in chap. 1.8 are not approved.

This expressly includes the following misuses (the list is not exhaustive), which pose risks despite the inherently safe construction and existing technical safety equipment:

- Non-observance of Operating Manual
- Non-observance of information and warnings on the chamber (e.g. control unit messages, safety identifiers, warning signals)
- Installation, startup, operation, maintenance and repair by untrained, insufficiently qualified, or unauthorized personnel
- Missed or delayed maintenance and testing
- Non-observance of traces of wear and tear
- Insertion of materials excluded or not permitted by this Operating Manual.
- Non-compliance with the admissible parameters for processing the respective material.
- Installation, testing, service or repair in the presence of solvents
- Installation of replacement parts and use of accessories and operating resources not specified and authorized by the manufacturer
- Installation, startup, operation, maintenance or repair of the chamber in absence of operating instructions by the operator
- Bypassing or changing protective systems, operation of the chamber without the designated protective systems
- Non-observance of messages regarding cleaning and disinfection of the chamber.
- Spilling water or cleaning agent on the chamber, water penetrating into the chamber during operation, cleaning or maintenance.
- Cleaning activity while the chamber is turned on.
- Operation of the chamber with a damaged housing or damaged power cord
- Continued operation of the chamber during an obvious malfunction
- Insertion of objects, particularly metallic objects, in louvers or other openings or slots on the chamber
- Human error (e.g. insufficient experience, qualification, stress, exhaustion, laziness)

To prevent these and other risks from incorrect operation, the operator shall issue operating instructions. Standard operating procedures (SOPs) are recommended.

1.10 Residual Risks

The unavoidable design features of a chamber, as well as its proper field of application, can also pose risks, even during correct operation. These residual risks include hazards which, despite the inherently safe design, existing technical protective equipment, safety precautions and supplementary protective measures, cannot be ruled out.

Messages on the chamber and in the Operating Manual warn of residual risks. The consequences of these residual risks and the measures required to prevent them are listed in the Operating Manual. Moreover, the operator must take measures to minimize hazards from unavoidable residual risks. This includes, in particular, issuing operating instructions.

The following list summarizes the hazards against which this Operating Manual and the Service Manual warn, and specifies protective measures at the appropriate spots:

Unpacking, Transport, Installation

- Sliding or tilting the chamber
- Setup of the chamber in unauthorized areas
- Installation of a damaged chamber
- Installation of a chamber with damaged power cord
- Inappropriate site of installation
- Missing protective conductor connection

Normal operation

- Assembly errors
- Contact with hot surfaces on the housing
- Contact with hot surfaces in the interior and inside of doors
- Emission of non-ionizing radiation from electrical operating resources
- Contact with live parts in normal state

Cleaning and Decontamination

- Penetration of water into the chamber
- Inappropriate cleaning and decontamination agents
- Enclosure of persons in the interior

Malfunction and Damage

- Continued operation of the chamber during an obvious malfunction or outage of the heating or the vacuum system
- Contact with live parts during error status
- Operation of a unit with damaged power cord

Maintenance

- Maintenance work on live parts.
- Execution of maintenance work by untrained/insufficiently qualified personnel
- Electrical safety analysis during annual maintenance not performed

Trouble-shooting and Repairs

- Non-observance of warning messages in the Service Manual
- Trouble-shooting of live parts without specified safety measures
- Absence of a plausibility check to rule out erroneous inscription of electrical components
- Performance of repair work by untrained/insufficiently qualified personnel
- Inappropriate repairs which do not meet the quality standard specified by BINDER
- Use of replacement parts other than BINDER original replacement parts
- Electrical safety analysis not performed after repairs

1.11 Operating instructions

Depending on the application and location of the chamber, the operator of the chamber must provide the relevant information for safe operation of the chamber in a set of operating instructions.



Keep these operating instructions with the chamber at all times in a place where they are clearly visible. They must be comprehensible and written in the language of the employees.

1.12 Measures to prevent accidents

The manufacturer took the following measures to prevent ignition and explosions:

- **Indications on the type plate**
See operating manual chap. 1.6.
- **Operating manual**
An operating manual is available for each chamber.
- **Overtemperature monitoring**
The chamber is equipped with a temperature display, which can be read from outside.
The chamber is equipped with an additional safety controller (temperature safety device class 2 acc. to DIN 12880:2007). Visual and audible (buzzer) signals indicate temperature exceeding.
- **Safety, measurement, and control equipment**
The safety, measuring, and control equipment is easily accessible.
- **Electrostatic charge**
The interior parts are grounded.
- **Non-ionizing radiation**
Non-ionizing radiation is not intentionally produced, but released only for technical reasons by electrical equipment (e.g. electric motors, power cables, solenoids). The machine has no permanent magnets. If persons with active implants (e.g. pacemakers, defibrillators) keep a safe distance (distance of field source to implant) of 30 cm, an influence of these implants can be excluded with high probability.
- **Protection against touchable surfaces**
Tested according to EN ISO 13732-1:2008.

-
- **Floors**
See operating manual chap. 3.4 for correct installation
 - **Cleaning**
See operating manual chap. 24.

DOMINIQUE DUTSCHER SAS

2. Description of the equipment

Vacuum drying is used for special drying problems, for which conventional drying methods cannot offer a solution due to physical limitations.

Controller

The chambers are equipped with a multifunctional microprocessor display controller with 2-channel technology for temperature and pressure. Temperature is indicated accurate to one-tenth of a degree, the pressure inside the chamber accurate to one 1 mbar. Pressure is measured by a firmly installed pressure sensor.

Standard RD4 controller: The chamber is regularly equipped with the RD4 controller. This efficient chamber controller is equipped with a multitude of operating functions, in addition to recorder and alarm functions. Set-point entry is easily accomplished directly via the chamber controller and is also possible directly with a computer via Intranet in connection with the optional APT-COM™ 4 Multi Management Software (option, chap. 23.1).

Option MB2 controller: The chamber is optionally available with the MB2 display program controller. This efficient program controller is equipped with a multitude of operating functions, in addition to recorder and alarm functions. Programming of test cycles is easily accomplished via the modern MB2 touch screen controller and is also possible directly with a computer via Intranet in connection with the APT-COM™ 4 Multi Management Software (option, chap. 23.1).

The chamber comes equipped with an Ethernet serial interface for computer communication and with a USB interface. In addition, the BINDER APT-COM™ 4 Multi Management Software permits networking up to 100 chambers and connecting them to a PC for controlling and programming, as well as recording and representing temperature and pressure data. For further options, see chap. 23.

Material

The inner chamber is made of especially corrosion resistant stainless steel V4A (German material no. 1.4404, US equivalent AISI 316L) micro-polished. The rack holder and all of the chamber's vacuum connections and valves are made of especially corrosion resistant stainless steel V4A (German material no. 1.4571, US equivalent AISI 316Ti). The housing is RAL 7035 powder-coated. All corners and edges are also completely coated. When operating the chamber at temperatures above 150 °C / 302 °F, the impact of the oxygen in the air may cause discoloration of the metallic surfaces (yellowish-brown or blue) by natural oxidation processes. These colorations are harmless and will in no way impair the function or quality of the chamber.

The chambers are jacket-heated. The preheating chamber technique ensures a completely homogeneous jacket temperature, ensuring uniform heat transfer into the inner chamber. The low-loss heat transfer to the material uses the aluminum vacuum expansion racks (or optionally available in stainless steel). The elastic-mounted safety glass window reliably compensates any overpressure or explosions that may occur. The additional laminated safety glass pane ensures proven and effective splinter protection in the event of an implosion.

The chambers provide a universal connection for inert gas / ambient air and a measuring connection serving to connect a measuring access port.

All installable items, such as racks and rack holders, can be easily removed. The completely smooth inner chamber with its rounded corners and internally welded seams is easy to clean.

The minimum working temperature of the vacuum drying oven is approx. 10 °C / 18 °F above room temperature. The maximum temperature is 220 °C / 428 °F.

Vacuum pumps with a suction capacity of 1 m³/h to 30 m³/h are suitable for the VD vacuum drying oven.

2.1 Chamber overview

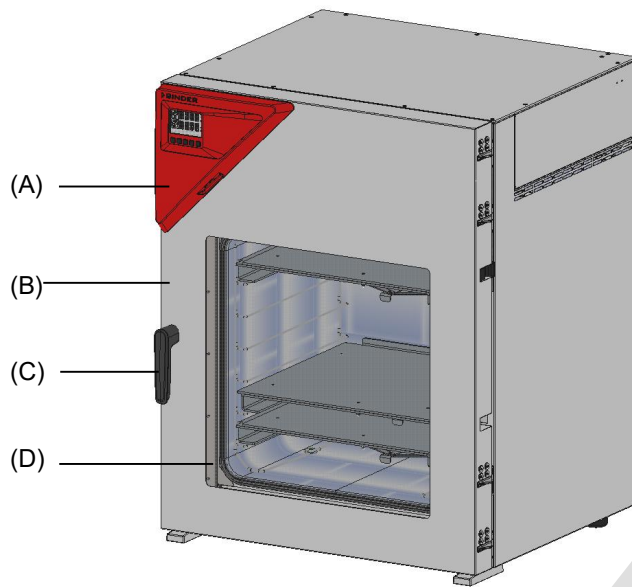

Figure 3: VD 115 with RD4 controller

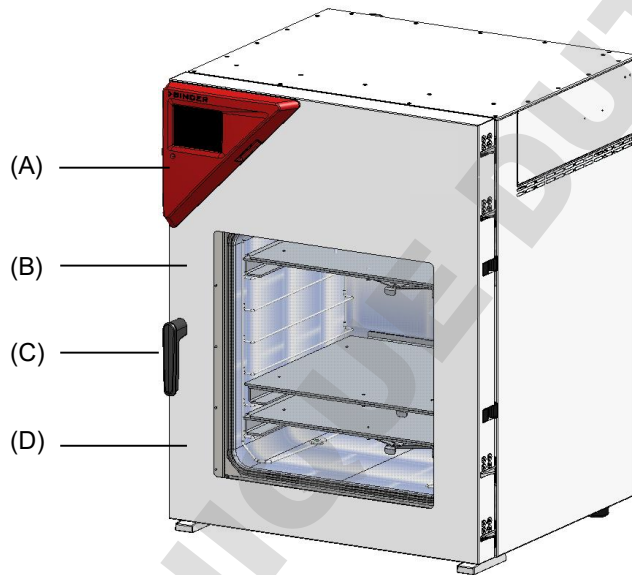

Figure 4: VD 115 with optional MB2 controller

- (A) Triangular instrument panel with chamber controller
- (B) Chamber door
- (C) Door handle
- (D) Elastic-mounted safety glass window

2.2 Instrument panel with regular RD4 controller

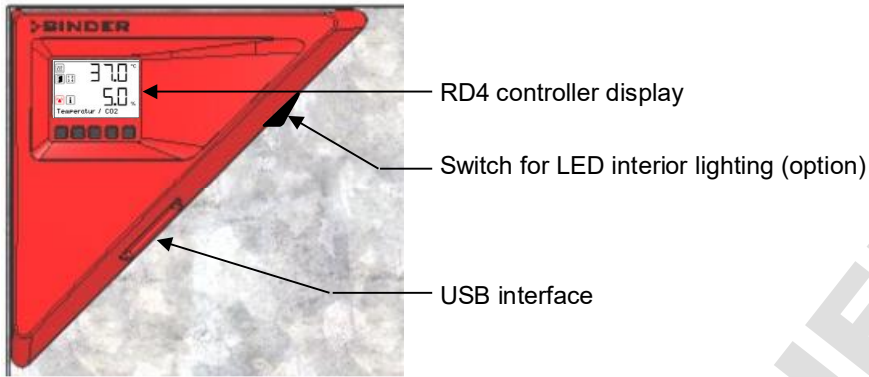

Figure 5: Instrument panel with RD4 controller and USB interface

2.3 Instrument panel with optional MB2 controller

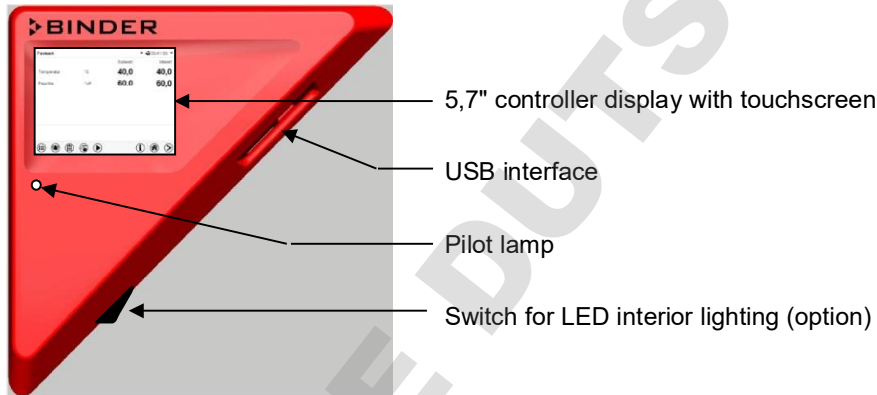

Figure 6: Instrument panel with MB2 program controller and USB interface

2.4 Connections on the rear of the chamber

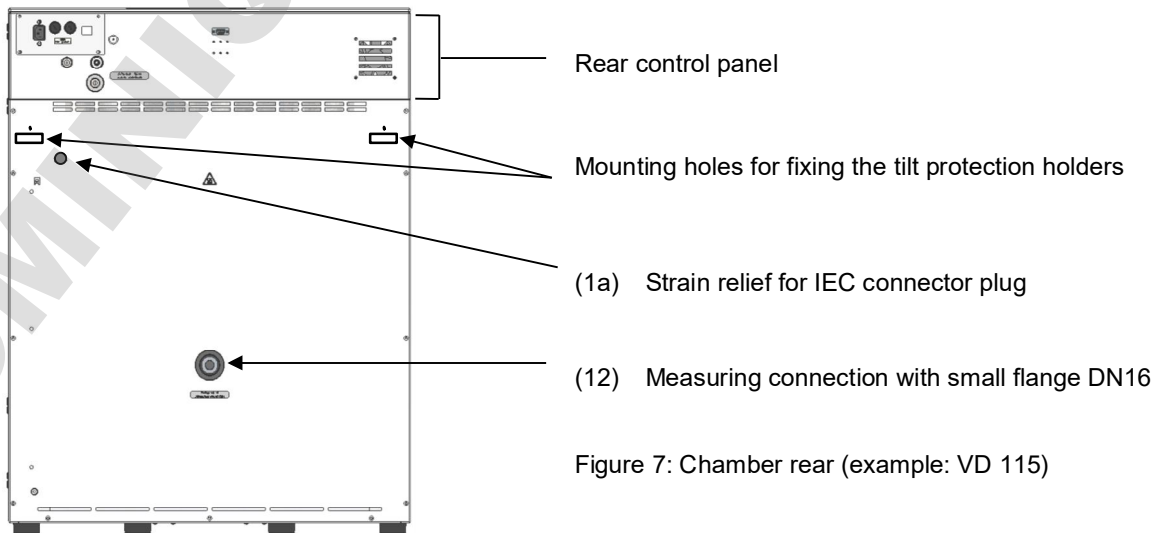

Figure 7: Chamber rear (example: VD 115)

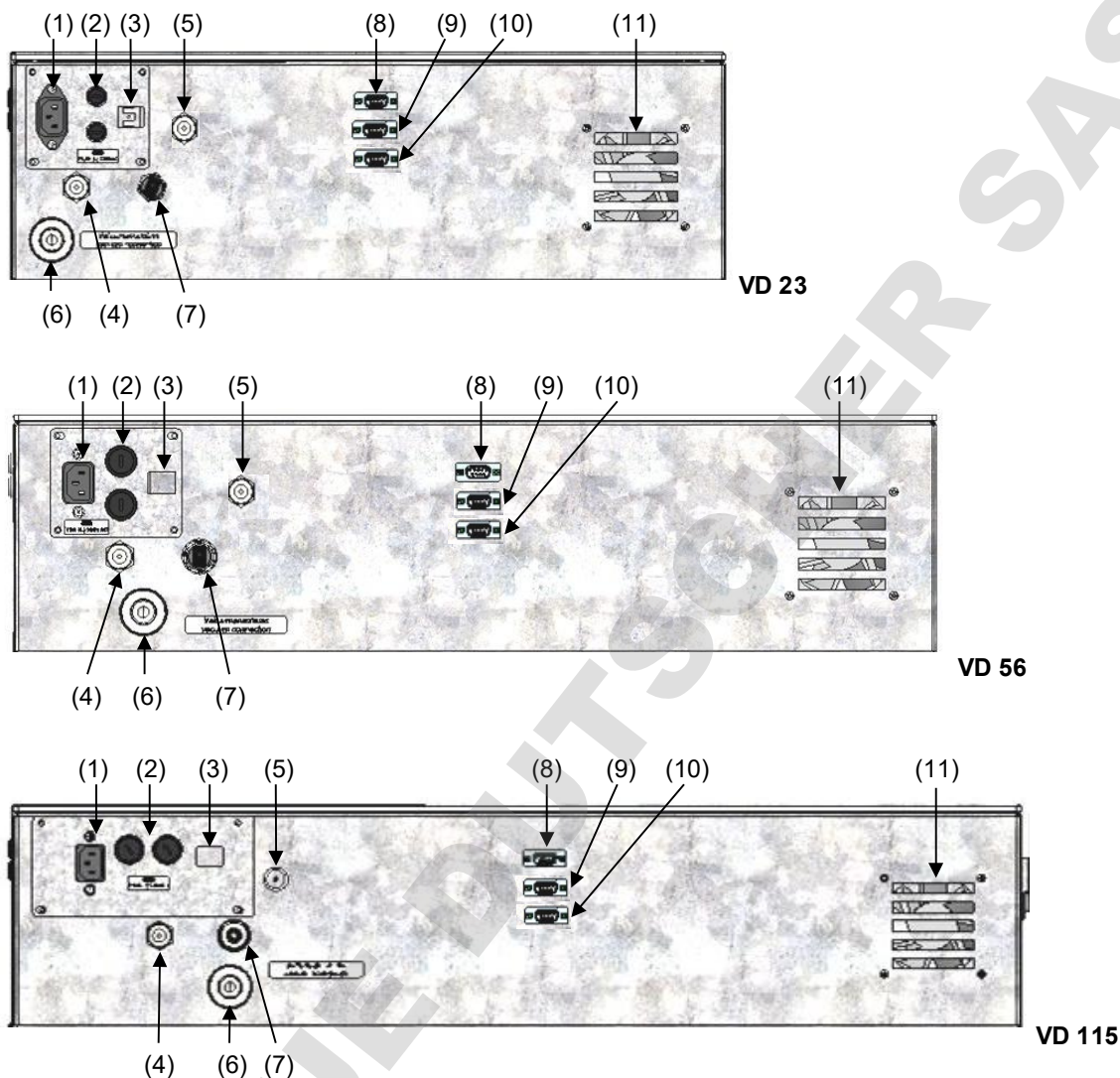

Figure 8: Rear control panel VD (230 V) with options

- (1) Connection for IEC connector plug 230 V AC for VD
Connection for IEC connector plug 100-120 V AC for VD -UL
- (2) Miniature fuses 250 V AC (T): 2x 6,3 A for VD 23, 2x 8 A for VD 56, 2x 10 A for VD 115, 1x 10 A for VD 23-UL, 2x 16 A for VD 56-UL, 2x 20 A for VD 115-UL
- (3) Ethernet interface for computer communication
- (4) Universal connection for inert gas / ambient air "GAS/AIR", adapter with hose olive \varnothing 8 mm / 0.31 in
- (5) Additional universal connection for inert gas / ambient air "GAS/AIR 2" (option), adapter with hose olive \varnothing 8 mm / 0.31 in
- (6) Vacuum connection with small flange DN16
- (7) Plug "Manual ventilation" for emergency ventilation in case of power failure
- (8) SUB-D socket "Pump module" for control line to turn on/off the vacuum pump via the socket on the pump module
- (9) SUB-D socket "Object temperature input" (option) for optional object temperature display
- (10) SUB-D socket "Analog output" (option) for optional analog outputs for temperature and pressure

3. Completeness of delivery, transportation, storage, and installation



3.1 Unpacking, and checking equipment and completeness of delivery

After unpacking, please check the chamber and its optional accessories, if any, based on the delivery receipt for completeness and for transportation damage. Inform the carrier immediately if transportation damage has occurred.

The final tests of the manufacturer may have caused traces of the shelves on the inner surfaces. This has no impact on the function and performance of the chamber.

Please remove any transportation protection devices and adhesives in/on the chamber and on the doors and remove the operating manuals and accessory equipment.

Due to different installation heights above sea level, a slight negative pressure in the inner chamber may prevent the door from being opened. Therefore after unpacking the chamber, remove the plug "Manual ventilation" (5) for emergency ventilation from the tube to ensure pressure equalization. **After this, thoroughly reinstall the plug.**

	<div style="background-color: yellow; text-align: center; padding: 5px;">  CAUTION </div> <p>Risk of injury and damages by lifting heavy loads and by sliding or tilting of the chamber due to improper lifting.</p> <p>Injuries, damage to the chamber.</p> <ul style="list-style-type: none"> ⊘ Do NOT lift the chamber using the door handle or the door. ➤ Lift chambers size 23 and 56 from the pallet at the four lower corners with the aid of 4 people. ➤ Lift chambers size 115 from the pallet with the aid of 6 people.
--	---

If you need to return the chamber, please use the original packing and observe the guidelines for safe lifting and transportation (chap. 3.2).

For disposal of the transport packing, see chap. 26.1.

If you ordered the optional pump module with a chemical membrane pump, the pump will be delivered in a separate box and must be fitted into the pump module and connected at the place of installation (see chap. 4.3.2).

Note on second-hand chambers (Ex-Demo-Units):

Second-hand chambers are chambers that were used for a short time for tests or exhibitions. They are thoroughly tested before resale. BINDER ensures that the chamber is technically sound and will work flawlessly.

Second-hand chambers are marked with a sticker on the chamber door. Please remove the sticker before commissioning the chamber.

3.2 Guidelines for safe lifting and transportation

After operation, please observe the guidelines for temporarily decommissioning the chamber (chap. 26.2).

	<div style="background-color: yellow; text-align: center; padding: 5px;">CAUTION</div> <p>Risk of injury and damages by lifting heavy loads and by sliding or tilting of the chamber due to improper transportation.</p> <p>Injuries, damage to the chamber.</p> <ul style="list-style-type: none"> ➤ Transport the chamber in its original packaging only. ➤ For moving or shipping, secure the chamber with transport straps. ⊘ Do NOT lift or transport the chamber using the door or handle. ➤ Lift chambers size 23 and 56 at the four lower corners with the aid of 4 people. ➤ Lift chambers size 115 with the aid of 6 people.
---	--

- Permissible ambient temperature range during transport: -10 °C / 14°F to +60 °C / 140°F.

You can order transport packing for moving or shipping purposes from BINDER Service.

3.3 Storage

Intermediate storage of the chamber in a closed and dry room. Observe the guidelines for temporary decommissioning (chap. 26.2).

- Permissible ambient temperature range during storage: -10 °C / 14°F to +60 °C / 140°F.
- Permissible ambient humidity: max. 70 % r.h., non-condensing



When after storage in a cold location you transfer the chamber to its warmer installation site, condensation may form. Before start-up, wait at least one hour until the chamber has attained ambient temperature and is completely dry.

3.4 Location of installation and ambient conditions

Set up the VD vacuum drying oven on a flat, even, and non-flammable surface, free from vibration, in a well-ventilated, dry location. Align it using a spirit level. The site of installation must be capable of supporting the chamber's weight (see technical data, chap. 27.3). The chambers are designed for setting up inside a building (indoor use).

	<div style="background-color: #00a0e3; color: white; text-align: center; padding: 5px;">NOTICE</div> <p>Danger of overheating due to lack of aeration.</p> <p>Damage to the chamber.</p> <ul style="list-style-type: none"> ⊘ Do NOT install the chamber in unventilated recesses. ➤ Ensure sufficient ventilation for dispersal of the heat. ➤ Observe the prescribed minimum distances when installing the chamber.
---	---

Do not install or operate the chamber in potentially explosive areas.

	 DANGER
	<p>Danger of explosion due to combustible dusts or explosive mixtures in the vicinity of the chamber.</p> <p>Serious injury or death from burns and / or explosion pressure.</p> <ul style="list-style-type: none"> ∅ Do NOT operate the chamber in potentially explosive areas. ➤ KEEP explosive dust or air-solvent mixtures AWAY from the vicinity of the chamber.

Ambient conditions

- Permissible ambient temperature range during operation: +18 °C / 64°F to +32 °C / 90°F.

	<p>The ambient temperature should not be substantially higher than the indicated ambient temperature of 22 °C +/- 3 °C to which the specified technical data relate. Deviations from the indicated data are possible for other ambient conditions.</p>
---	--

- Permissible ambient humidity: 70 % r.h. max., non-condensing.
- Installation height: max. 2000 m / 6562 ft above sea level.

Minimum distances

- Distance between several chambers of the same size: 250 mm / 9.8 in
- Wall distances to rear: 100 mm / 3.9 in
- Lateral wall distances: 70 mm / 2.76 in
- Spacing above and behind the chamber: 100 mm / 3.9 in.

	NOTICE
	<p>Danger by stacking.</p> <p>Damage to the chambers.</p> <ul style="list-style-type: none"> ∅ Do NOT place the chambers on top of each other.

Other requirements



To completely separate the chamber from the power supply, you must disconnect the power plug. Install the chamber in a way that the power plug is easily accessible and can be easily pulled in case of danger or to turn off the chamber.

The maximum permissible ambient temperature of the vacuum pumps supplied by BINDER is 40 °C / 104 °F.

Notes when using inert gas:

When operating the VD vacuum drying oven with inert gas, correctly follow the technical ventilation measures, as described in the DGUV guidelines 213-850 on safe working in laboratories, issued by the employers' liability insurance association (for Germany).

For operation with inert gas, the chamber is supplied with an oxygen-displacing gas, e.g. N₂. Inert gases in high concentrations are hazardous to health. They are colorless and almost odorless and therefore practically imperceptible. Inhalation of inert gases can cause drowsiness up to respiratory arrest. When the O₂ content of the air decreases below 18%, there is risk of death from lack of oxygen. Any gas that might escape has to be led out via good room ventilation or a suitable exhaust system.

	 DANGER
	<p>Suffocation hazard due to high concentration of inert gas. Death by suffocation.</p> <ul style="list-style-type: none"> ⊘ Do NOT set up chambers in non-ventilated recesses. ➤ Make sure that technical ventilation measures are active. ➤ Respect the relevant regulations for handling inert gases. ➤ When decommissioning the vacuum drying oven, shut off the inert gas supply.

4. Installation and connections

4.1 Vacuum expansion racks and rack holders

Vacuum expansion racks and rack holders can easily be removed from the chamber. This offers the advantage of an inner chamber with smooth walls, which is easy to clean.

The rack holders can only be removed from the chamber after removing the expansion racks.

Rack holder installation: Align the rack holders to the cams in the bottom of the inner chamber and insert them.

The low-loss heat transfer to the material occurs via the aluminum vacuum expansion racks (also available in stainless steel as an option). The strong tension causes the racks to fit tightly against the interior wall and their large-surface contact area ensures rapid and effective heat transfer.

The removable rack holders allow for easy positioning.

You can also remove the expansion racks for easy cleaning. Do not remove them too often in order to prevent wear.



Figure 9: Using the expansion racks

- Pushing the locking lever: The expansion rack is released and can be removed.
- Pulling the locking lever: The expansion rack is pressed against the inner chamber walls.

	<p>Following each new tightening of an expansion rack, check that the lateral parts of the rack fit closely over their whole surface to the inner chamber wall. This is necessary in order to ensure the specified temperature exactitude.</p>
---	--

	NOTICE
	<p>Danger of invalid calibration caused by modified thermal conductivity when changing between aluminum and stainless steel racks. Undefined heating performance.</p> <ul style="list-style-type: none"> ⊘ Do NOT change between aluminum and stainless steel racks. ➤ Operate the chamber with the supplied expansion racks only.

4.2 Mounting the tilt protection holders

For chambers placed on the optional pump module it is recommended to install the supplied tilt protection.

Scope of delivery of tilt protection kit (Art.no. 8009-0870):

- 2 screws
- 2 tilt protection holders

Preparing the tilt protection holders

- Depending on the desired wall distance, you can bend the tilt protection holders accordingly.

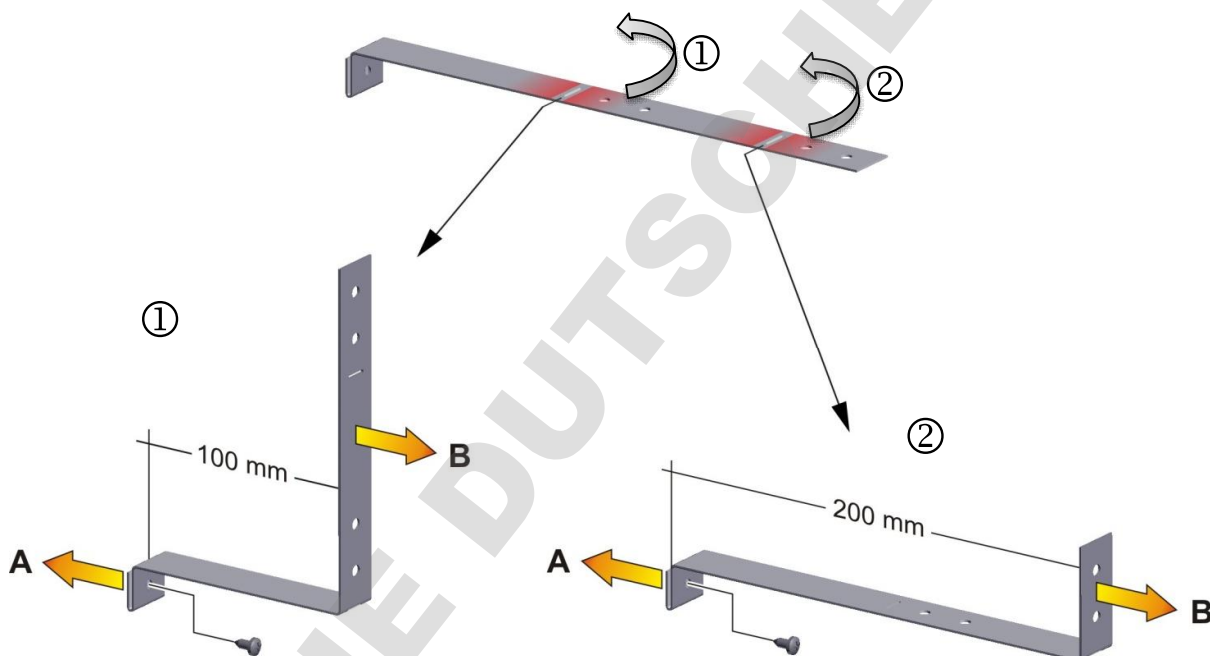

Figure 10: Variable length of the tilt protection holder depending on the bend

Installation on the chamber

- Plug the two tilt protection holders each with the tab into the mounting holes and push them upward over the rear panel. The screw holes in the rear wall and in the tilt protection holders must align.
- Fix the tilt protection holders each with one of the supplied screws on the chamber rear wall.

Wall mounting

- Then fix both tilt protection holders on the wall, each with 2 screws \varnothing 6mm suitable for the wall (B)

4.3 Pump module (option)

	<p>The mounting instructions Art. no. 7001-0137 supplied with the pump module describe how to mount the VD vacuum drying oven onto the pump module and installing the suction line into the pump module.</p>
---	--

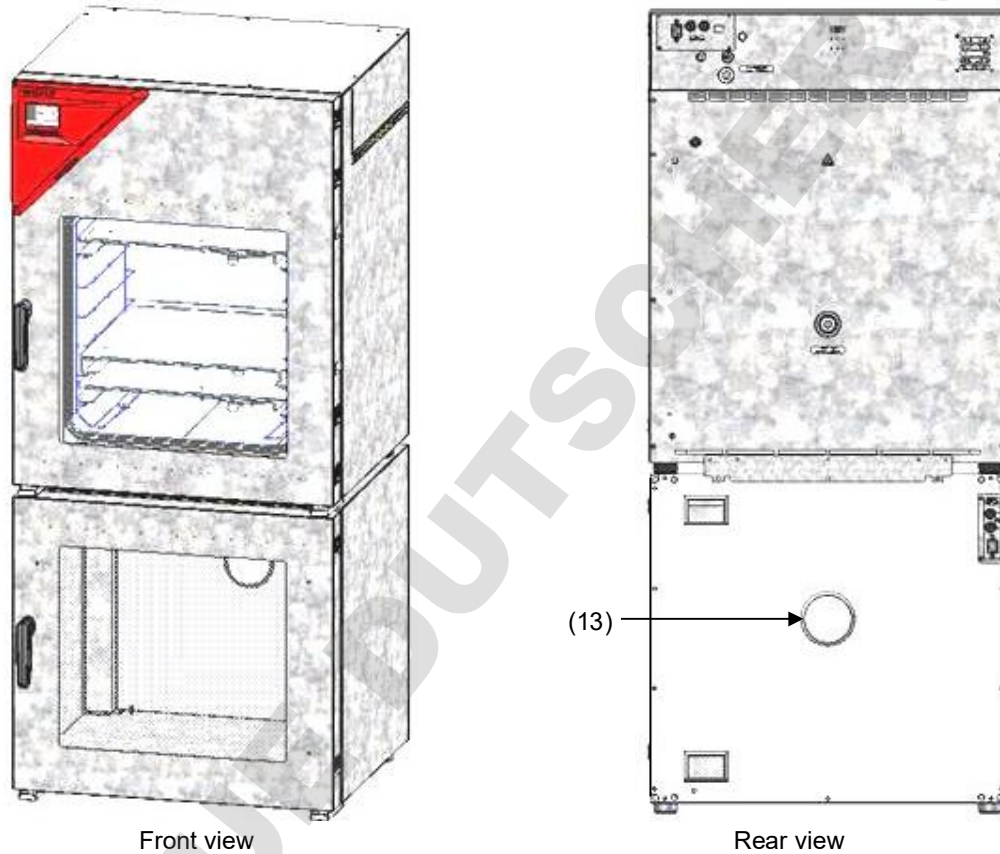

Figure 11: VD mounted on pump module (example: size 115)

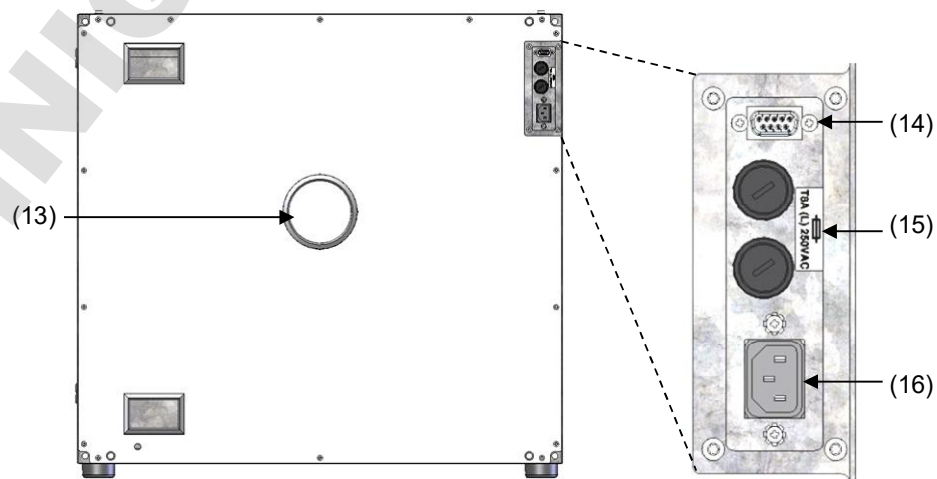
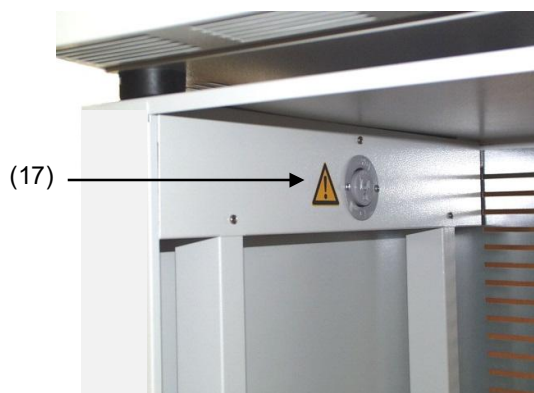

Figure 12: Pump module, rear view with connection panel (example: size 115)



- (13) Connection for extraction
- (14) SUB-D socket to turn on/off the vacuum pump
- (15) Miniature fuse 8,0 A 250 V AC (T) 5x20mm for vacuum pump 230 V or 120 V
- (16) Connection socket 230 V / 16 A for IEC connector plug 230 V AC to vacuum pump 230 V
Connection socket 125 V / 15 A for IEC connector plug 100-120 V AC to vacuum pump 120 V
- (17) Electrical connection socket for the vacuum pump

Figure 13: Pump module, interior view with socket for the vacuum pump

Maximum admissible load of the socket:

Standard	230 V / 50 Hz - 16 Amp
cUL-version	120 V / 60 Hz - 13 Amp

	With CUL-version, connect only a UL listed vacuum pump with ratings of 120 V AC, 60 Hz, and less or equal 12 Amp, 0.5 HP.
---	---



Mounting the VD on the pump module is described in detail in the mounting instructions Art. No. 7001-0137. Proceed accordingly.

4.3.1 Pump module without pump (option)

Connection to a vacuum source

Connect the vacuum connection (6) (small flange DN 16) at the rear of the chamber at the top to a vacuum pump or to a domestic vacuum system via a vacuum hose or a fixed vacuum pipe.

When using a vacuum hose, we recommend using the BINDER VD connection kit (Art. no. 8012-1995) (chap. 4.4.1). The pump module has an appropriate hose outlet at the back.

	 WARNING
<p>Danger of health damage due to the release of extracted vapors. Corrosion on the VD and pump. Damage to health.</p> <ul style="list-style-type: none"> ➤ Remove the extracted vapors from the pump module via a suitable hose into e.g., a fume extractor facility. ➤ Connect the hose to the vacuum pump outlet. 	

4.3.2 Pump module with pump stand (option)

The VAP 1 / VAP 2 pump stand is located in a separate transport packaging. With this option, the mounted system, consisting of VD and pump module, has a total of two power supply leads.

The connection of the control line for switching on/off the vacuum pump via the pump module socket is realized as 9-poles SUB-D socket "Pump module" (8) located in the VD rear control panel.

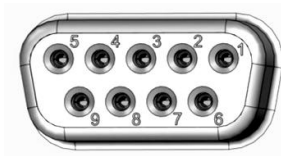

The connection is established via PIN 6 and PIN 7.
A 1.2 m cable with fitting plugs is enclosed.

Figure 14: Pin configuration of the SUB-D socket “Pump module” (8) to switch on/off the pump module socket

Installation of the supplied vacuum pump

- The vacuum drying oven is mounted onto the pump module as described in the mounting instructions Art. No. 7001-0137.
- The suction line to the pump module is installed as described in the mounting instructions Art. No. 7001-0137.
- When the pump is removed from the original packaging, place it in the pump module.
- Push the pre-installed suction line onto the opening of the vacuum pump (hose olive above the suction-side condensate piston).
- Insert the shockproof plug of the vacuum pump into the permanently installed socket (17) in the pump module.
- Push a suitable hose for removing the extracted vapors from the pump module onto the pressure-side connection of the vacuum pump (hose olive at the back of the emission condenser at the top).
- Lead the hose end into an exhaust air unit.
- Connect SUB-D socket (14) at the pump module to SUB-D socket (8) in the VD rear control panel via the supplied 1.2 m cable.

Extracted vapors and the inert gas used if necessary can have a health-endangering and / or corrosive effect on the chamber and the pump.

	<p style="text-align: center;">WARNING</p> <p>Danger of injury by release of extracted vapors. Corrosion on the chamber and the pump. Damage to health.</p> <ul style="list-style-type: none"> ➤ Remove the extracted vapors from the pump module via a suitable hose into e.g., a fume extractor facility. ➤ Connect the hose directly to the vacuum pump outlet.
---	---

	<p>You can connect a laboratory cooling system to the emission condenser of the vacuum pumps VAP 1 / VAP 2.</p>
---	---

	<p>For operating the vacuum pumps VAP 1 / VAP 2, please refer to the enclosed pump operating manual.</p>
---	--

 BINDER vacuum pumps are designed for a gas inlet temperature of von max. 40 °C / 104°F.

Observe the permitted gas inlet temperature. The following values refer to the maximum ambient temperature of the pump of 40 °C / 104 °F.

Operation condition	Inlet pressure	Permitted gas temperature
Continuous operation	> 100 mbar / 2.95 inHg (high gas load)	+10 °C to +40 °C / 50°F to 104°F
Continuous operation	< 100 mbar / 2.95 inHg (low gas load)	0 °C to +60 °C / 32°F to 140°F
Short-time operation (< 5 min.)	< 100 mbar / 2.95 inHg (low gas load)	-10 °C to +80 °C / 50°F to 176°F

Do not exceed the permitted gas inlet temperature. An excessive gas inlet temperature may diminish the lifetime of the pump.

NOTICE	
	<p>Danger of damage to the vacuum pump by exceeding the gas inlet temperature. Impairment of the lifespan of the vacuum pump.</p> <p>Ø Do NOT exceed the set-point temperature of the permitted gas temperature.</p> <p>➤ With higher set-point temperature, take appropriate measures to cool down the sucked-in gas before its entry to the vacuum pump</p>

4.4 Vacuum connection

Always connect the VD vacuum drying oven to a vacuum pump or to a domestic vacuum system. For this purpose, the vacuum connection (6) with small flange DN16 must be connected to the back of the chamber at the top with the vacuum pump or domestic vacuum system via a vacuum suction hose. For connecting to the chamber, BINDER recommends the connection kit VD, Art. no. 8012-1995. The optional pump module (Chap. 4.3) has a corresponding hose outlet on its rear.

 Vacuum pumps with a suction capacity of 1-30 m³/h are suitable for the VD vacuum drying oven.

4.4.1 VD connection kit for VAP1-VAP2 (option)

The VD connection kit (Art. no. 8012-1995) consists of:

- Aluminum straining ring DN10/16
- Outer centering ring DN10/16
- Small flange with hose tulle DN16/8
- 2.5 m / 98.4 in India rubber hose DN 8
- 2 hose clamps





Figure 15: VD connection kit for VAP1-VAP2

4.5 Connecting inert gas supply

When operating the VD vacuum drying oven with inert gas, correctly follow the technical ventilation measures, as described in the DGUV guidelines 213-850 on safe working in laboratories, issued by the employers' liability insurance association (for Germany).

When operating with inert gas, the chamber is supplied with an oxygen displacing gas, e.g., N₂. Inert gases in high concentrations are hazardous to health. They are colorless and almost odorless and therefore practically imperceptible. Inhalation of inert gases can cause drowsiness up to respiratory arrest. When the O₂ content of the air decreases below 18%, there is risk of death from lack of oxygen. Any gas that might escape has to be led out via good room ventilation or a suitable exhaust system.

	 DANGER
	<p>Risk of suffocation by inert gas in a high concentration. Death by suffocation.</p> <ul style="list-style-type: none"> ∅ Do NOT set up chambers in non-ventilated recesses. ➤ Ensure that technical ventilation measures are activated. ➤ Respect the relevant regulations for handling inert gases. ➤ When decommissioning the vacuum drying oven, turn off the inert gas supply.

Connect the inert gas supply to the universal connection for inert gas / ambient air (adapter with hose olive diameter 8 mm / 0.31 in) via a pressure reducer. Screw the enclosed adapter with hose olive on the thread (4) at the chamber rear. Set the pressure reducer to a pressure slightly above ambient pressure. Ensure that the pressure reducer will certainly open. Do not alter this setting in order to avoid perturbation inside the oven and release of big quantities of inert gas after flooding the VD.



	NOTICE
	<p>Danger of perturbations by overpressure in the inner chamber. Perturbation of the load.</p> <ul style="list-style-type: none"> ∅ DO NOT change the setting of the atmospheric pressure.

4.6 Electrical connection

The chambers are supplied ready for connection. They come with an IEC connector plug.

Model	Power plug of the power cable	Nominal voltage $\pm 10\%$ at the indicated power frequency	Current type	Chamber fuse
VD 23	IEC connector plug (grounded)	230 V at 50 Hz 230 V at 60 Hz	1N~	2 x 6,3 A
VD 56	IEC connector plug (grounded)	230 V at 50 Hz 230 V at 60 Hz	1N~	2 x 8 A
VD 115	IEC connector plug (grounded)	230 V at 50 Hz 230 V at 60 Hz	1N~	2 x 10 A
VD 23-UL	NEMA 5-15P	100-120 V at 60 Hz	1N~	10 A
VD 56-UL	NEMA 5-20P	100-120 V at 60 Hz	1N~	2 x 16 A
VD 115-UL	NEMA 5-20P	100-120 V at 60 Hz	1N~	2 x 20 A

- The domestic socket must also provide a protective conductor. Make sure that the connection of the protective conductor of the domestic installations to the chamber's protective conductor meets the latest technology. The protective conductors of the socket and plug must be compatible!

	 DANGER
	<p>Electrical hazard due to missing protective conductor connection. Deadly electric shock.</p> <ul style="list-style-type: none"> ➤ Make sure that the chamber's power plug and the power socket match and securely connect the electrical protective conductors of the chamber and the house installation.

- Prior to connection and start-up, check the power supply voltage. Compare the values to the specified data located on the chamber's type plate (chamber front behind the door, bottom left-hand, see chap. 1.6).

	NOTICE
	<p>Danger of incorrect power supply voltage due to improper connection. Damage to the chamber.</p> <ul style="list-style-type: none"> ➤ Check the power supply voltage before connection and start-up. ➤ Compare the power supply voltage with the data indicated on the type plate.

- When connecting, please observe the regulations specified by the local electricity supply company and as well as the VDE directives (for Germany). We recommend the use of a residual current circuit breaker.
- After connecting the power cable to connection (1), lead it through the strain relief (1a).
- Only use original connection cables from BINDER according to the above specification
- Pollution degree (acc. to IEC 61010-1): 2
- Over-voltage category (acc. to IEC 61010-1): II

See also electrical data (chap. 27.3).

	<p>To completely separate the chamber from the power supply, you must disconnect the power plug. Install the chamber in a way that the power plug is easily accessible and can be easily pulled in case of danger or to turn off the chamber.</p>
---	---

5. Functional overview and menu structure of the controller

The available controller functions depend on the current authorization (chap. 9). Unless noted otherwise, the figure in this manual show the functional range, which is available for the user with "Admin" authorization level

5.1 RD4 controller

The RD4 chamber controller controls following parameters inside the chamber:

- Temperature in °C or °F
- Pressure in mbar

You can enter the desired set point values in the "Set points" menu directly at the controller or use the APT-COM™ 4 Multi Management Software (option) specially developed by BINDER.

The controller offers various notifications and alarm messages with visual and audible indication. All controller setting remain valid until the next manual change. They are stored also after turning off the chamber.

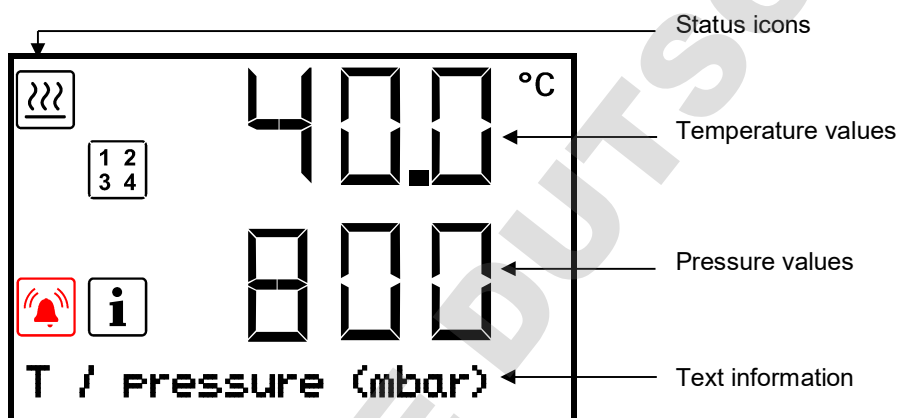

Figure 16: Normal display of the RD4 controller (sample values)



Depending on the configuration, pressure values are shown in mbar or psi.

Status icons in the controller display

Icon	Signification	Icon	Signification
	Heating active		Display of activated special controller functions: 1 = Standby mode 2 = Optional universal connection for inert gas / ambient air "GAS/AIR 2" (5) activated 3 = All valves closed 4 = Vacuum pump switched off
	Information		
	Collective alarm		

Functional controller keys

Icon	Signification	Function
	Arrow-up button	<ul style="list-style-type: none"> • Navigate between menus, submenus, other functions • In the setting menu: change setting, decrease value
	Arrow-down button	<ul style="list-style-type: none"> • Navigate between menus, submenus, other functions • In the setting menu: change setting, increase value

Icon	Signification	Function
	OK button	<ul style="list-style-type: none"> Select menu, submenu, function In the setting menu: Confirm entry
	Back button	<ul style="list-style-type: none"> Back to previous menu level. Press down 5 seconds to simultaneously display the inner chamber temperature and the heating element temperature (chap. 10.1.8)
	Standby button	Turning on / off the chamber (chap. 6.2)

5.1.1 Menu structure of the controller and access levels

Starting from Normal display, navigate between the menus with the **arrow buttons**. With the **OK button** you enter the setting of further subordinate menu functions. With the **Back button** you go back to the previous function and finally back to Normal display.

Starting from Normal display you can directly access the quick access menu functions with the **OK button**.

The available functions depend on the current dependent on the current **authorization** "User", "Admin" or "Service", for which the entry of a password may be required, depending on the setting.

You can set **passwords** for different access levels:

- **User:** The password enables access to the standard operating functions. Factory setting is 00 00 (no password assigned).
- **Admin:** The password enables access to advanced controller functions and settings. Factory setting is 00 01.
- **Service:** The password enables access to all controller functions (for BINDER Service only).

As soon as a password has been assigned, access to the respective functions is blocked and only available after entering the correct password.

Menu	Required access level	Functions
Quick access	Any user	<ul style="list-style-type: none"> Turning on / off pressure control and temperature control Starting / stopping Drying monitoring
Setpoints	"User"	<ul style="list-style-type: none"> Temperature and pressure set-point setting Setting the safety controller Turning on / off the vacuum pump and the optional connection "GAS/AIR 2" (5) Closing all fine dosing valves
Programs	"User"	<ul style="list-style-type: none"> Start / Stop function for time and week program
Chamber info	Any user	<ul style="list-style-type: none"> Configuration display (setup information, controller hardware and software, analog inputs) Display of interface configuration (e.g. MAC address, IP address)
Settings	"Admin"	<ul style="list-style-type: none"> General controller settings (date, time, menu language, temperature unit, display brightness...) Network settings Setting the data logger storage interval Setting the tolerance range limits and delay times for tolerance range alarms Password changing for User and Admin

Menu	Required access level	Functions
Service	“Service”	<ul style="list-style-type: none"> • Configuration settings (only for BINDER Service) • Password changing for User and Admin
USB	Export: Any user Import: “Admin”	<ul style="list-style-type: none"> • Export of configuration, logger, and service data • Import of configuration data

Unless noted otherwise, the figure in this manual show the functional range, which is available for the user with “Admin” authorization level

Note: When specifying the path to the respective function, the possibly required entry of a password is not listed.

5.2 MB2 controller

The MB2 chamber controller controls following parameters inside the chamber:

- Temperature in °C or °F
- Pressure in mbar

You can enter the desired set point values in fixed value operation mode directly on the display surface or via the setpoint menu. For program operation the controller offers programming week and time programs. In addition there is a timer program available (stopwatch function).

The controller offers various notifications and alarm messages with visual and audible indication and remote alarms via e-mail, an event list (trace file) and the graphical display of the measuring values in the in der chart recorder view. The MB2 program controller permits programming temperature and pressure cycles, and specifying special controller functions for each program section. You can enter values or programs directly at the controller or use the APT-COM™ 4 Multi Management Software (option) specially developed by BINDER.

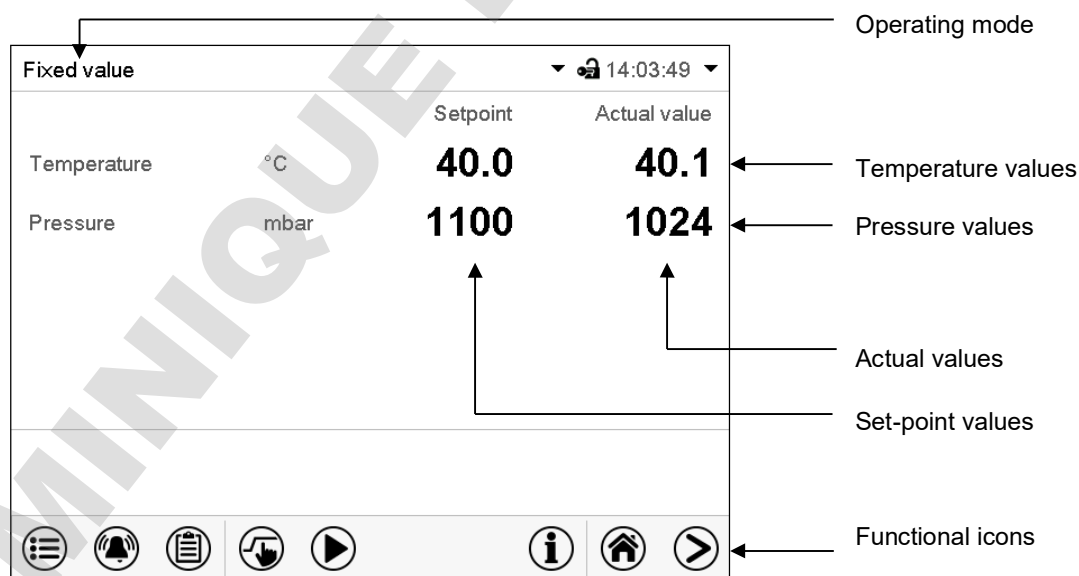

Figure 17: Normal display of the MB2 program controller (sample values)

5.2.1 Operating functions in normal display

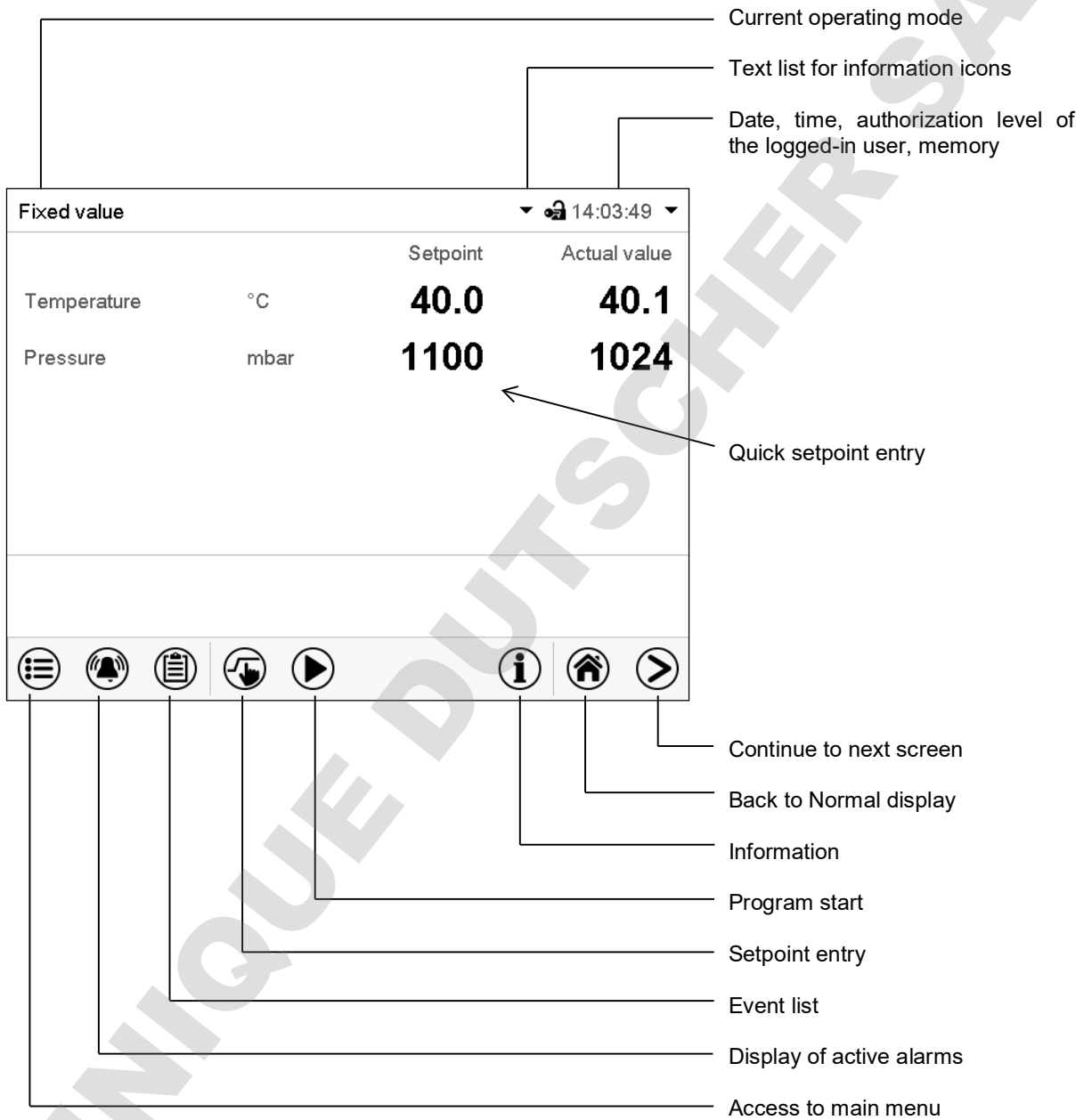

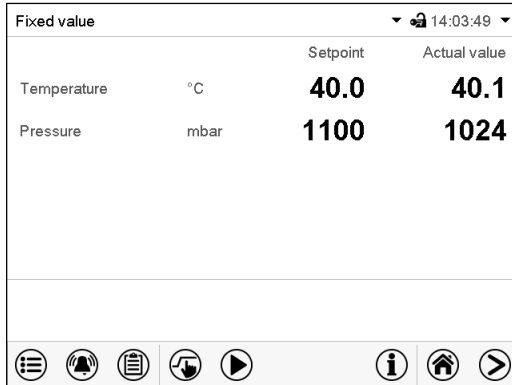

Figure 18: Operating functions of the MB2 controller in normal display (example values)

5.2.2 Display views: Normal display, program display, chart-recorder display

	Press the Change view icon to toggle between normal display, program display and chart-recorder display.
	Press the Normal display icon to return from program display and chart recorder display back to Normal display.



Normal display (actual values / setpoint values)

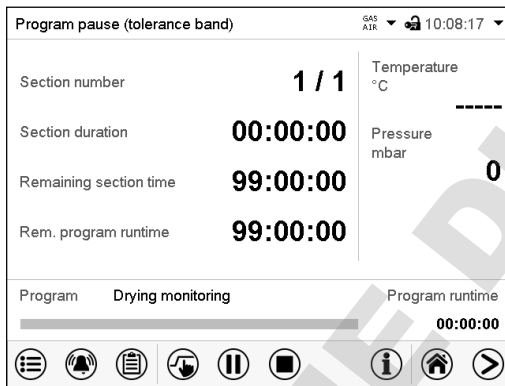

Program display (example: time program)

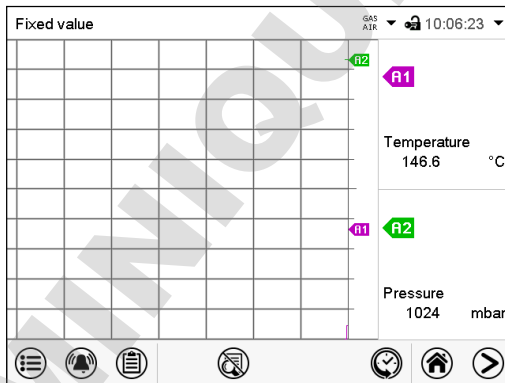



















Chart recorder display

5.2.3 MB2 controller icons overview









Navigation icons in Normal display

Icon	Signification	Function
	Main menu	Access from Normal display to the main menu
	Alarm	Access from Normal display to the list of active alarms
	Event list	Access from Normal display to the event list
	Setpoint setting	Access from Normal display to the setpoint entry menu: setpoint entry for Fixed value operation, turning on/off temperature and/or pressure control, safety controller settings
	Program start	Start a previously entered time or week program, continue a paused time program
	Program pause	Pause a running time program
	Program cancelling	Cancel a running time or week program
	Information	Information on program operation, setpoints, actual values, and the safety controller
	Normal display	Return from program display or chart recorder display to Normal display
	Change view	Toggle between Normal display, program display, and chart recorder display







Functional icons in individual menus

Icon	Signification	Function
	Back	Return from each menu to Normal display
	Update	Update the event list and alarm messages
	Confirm	Take over the entries and exit the menu / continue menu sequence.
	Close	Exit the menu / cancel menu sequence. Entries are not taken over. When terminating a menu sequence, an information window appears, which must be confirmed.
	Reset alarm	Acknowledge the alarm and mute the buzzer.
	Change keyboard	Change between uppercase and lower case characters, digits and special characters
	Edit	Edit settings of time and week programs

Functional icons in the chart recorder display

Icon	Signification	Function
	Show legend	Show legend
	Hide legend	Hide legend
	History display	Pause chart recorder and change to history display. Data recording continues.
	Curve selection	Go to "Curve selection" submenu in the history display
	Search	Go to "Search" submenu in the history display to select the required instant
	Zoom	Go to "Zoom" submenu in the history display to select the zoom factor
	Show scroll buttons	Show scroll buttons in the history display to scroll to an instant
	Hide scroll buttons	Hide scroll buttons in the history display to scroll to an instant

Information icons referring to chamber conditions

Icon	Text information	Condition
	„Standby“	Chamber is in Standby mode
	“Heating active”	Chamber is heating up
	“All valves are closed”	All valves are closed
	“GAS/AIR”	Ventilation via regular connection “GAS/AIR” (4)
	“GAS/AIR 2”	Ventilation via optional connection “GAS/AIR2” (5) Regular connection “GAS/AIR” (4) deactivated.
	“Vacuum pump off”	Vacuum pump turned off

Information icon for data processing

Icon	Information
	Waiting icon: Data processing is running. Remaining time to touch the display when calibrating the touchscreen.

5.2.4 MB2 controller operating modes

The MB2 program controller operates in the following operating modes:

- **Fixed value operating mode**

The controller operates as a fixed-point controller, i.e., set-points for temperature and pressure can be defined, which are then maintained until the next manual change (chap. 7.2.1).

- **Timer program operation**

Stopwatch function: during an entered duration the controller constantly equilibrates to the setpoints entered in Fixed value operation mode.

- **Time program operation**

An entered time program for temperature and pressure is running. The controller offers 25 program memory places with 100 program sections each. The total number of program sections of all programs is unlimited

- **Week program operation**

An entered week program for temperature and pressure is running. The controller offers 5 program memory places with 100 switching points each. The switching points can be distributed over all days of the week.

5.2.5 MB2 controller menu structure





Fixed value		Setpoint	Actual value
Temperature	°C	40.0	40.1
Pressure	mbar	1100	1024

14:03:49



Use the **navigation icons** in the screen footer in Normal display to access the desired controller functions.



The available functions depend on the current **authorization level** “Service”, “Admin” or “User” (chap. 9.2.1). This is selected either during login or can be available without password protection.

	Main menu: program settings, further information, “Service” submenu. The “Settings” submenu allows general configuration of the controller.	chap. 5.2.5.1
	List of active alarms	chap. 13.2
	Access to the event list	chap. 10.2.5
	Setpoint entry for Fixed value operation, Standby mode, turning on/off temperature and/or pressure control , safety controller settings	chap. 7.2.1, 8.6.2, 11.2.2.3
	Start/ pause/ cancel an already entered, respectively a running time program or start / cancel an already entered, respectively a running week program	chap. 16.1, 16.2, 17.1

Unless noted otherwise, the figures show the functional range, which is available for the user with “Admin” authorization level.

5.2.5.1 Main menu

The main menu provides access to the general configuration of the controller as well as to program entry and the user administration. Additionally there are support functions like a contact page or the display calibration depending on the available angle.

	Press the Main menu icon to access the main menu from Normal Display.
	Press the Back icon to return from each setting menu to Normal Display.

The main menu provides the following functions and submenus.

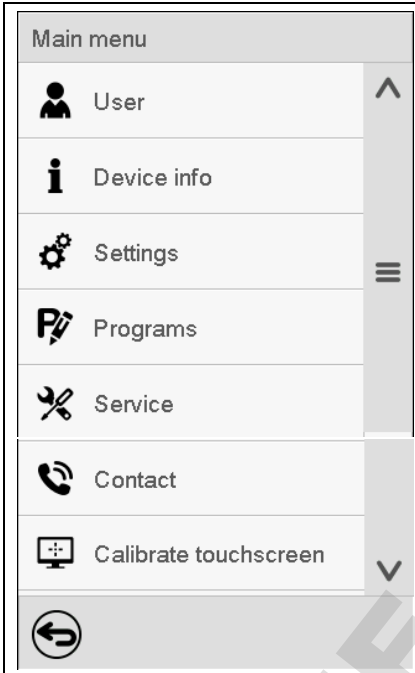
		
	User management: login and logout, password management	chap. 9.2.1
	Chamber information	chap. 10.2.7
	“Settings” submenu (not visible for user with “User” authorization level)	chap. 10
	Program start/stop submenu for time and week programs (not visible for user with “User” authorization level)	chap. 16 and 17
	“Service” submenu	chap. 5.2.5.3
	BINDER Service contact page	chap. 10.2.6
	Calibrating the touch screen	chap. 10.2.4.2
	Back to Normal Display	

“Settings” submenu

- Settings of many general controller functions and network settings (chap. 10).
- Available only for users with “Service” and “Admin” authorization level

“Service” submenu

- Access to service data, controller reset to factory settings (chap. 5.2.5.3)
- Available only for users with “Service” and “Admin” authorization level. Full functional range only for BINDER Service (users with “Service” authorization level).

“Programs” submenu

- Access to the controller’s program functions (chap. 15, 16, 17)
- Available only for users with “Service” and “Admin” authorization level

5.2.5.2 “Settings” submenu

The “Settings” submenu is available for users with “Service” or “Admin” authorization level. It serves to enter date and time, select the language for the controller menus and the desired temperature unit and to configure the controller’s communication functions.

Path: [Main menu > Settings](#)

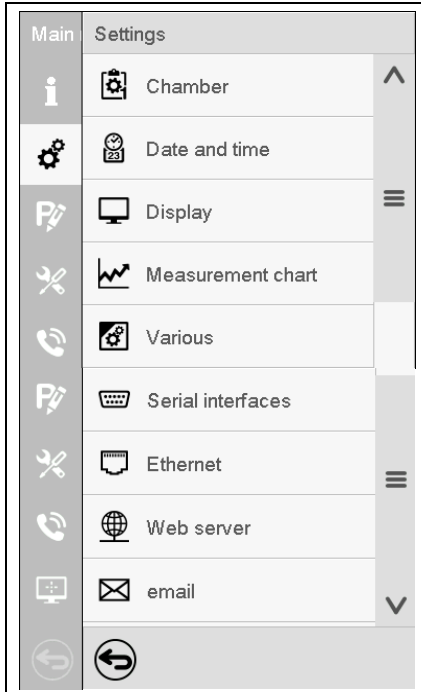
	Setting the temperature unit, menu language...	chap. 10.1.1, 10.2.2
	Setting date and time	chap. 10.2.2
	Setting the display brightness, continuous operation and screen saver	chap. 10.2.4
	Settings for the measurement chart: storage interval, storage values, minimum and maximum values	chap. 21.2
	Setting the tolerance range and delay time for tolerance range alarm	chap. 12
	(not used)	
	Entry of the MAC address and IP address	chap. 18.2.1
	Password protection for web server access	chap. 18.2.2
	Configuration of the e-mail server, assignment of e-mail addresses	chap. 18.2.3
	Back to main menu	

5.2.5.3 “Service” submenu

The “Service” submenu is available for users with “Service” or “Admin” authorization level. When logged-in with “Admin” authorization level the user will find information to tell the BINDER Service in service case.

Path: [Main menu > Service](#)

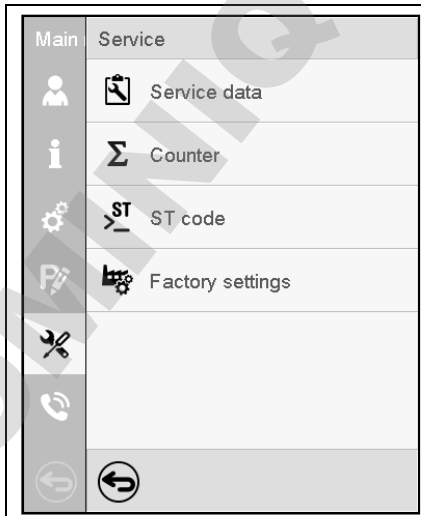
	Serial number of the chamber, setup version of the controller software	chap. 10.2.2
	No function	
	Information for BINDER Service	
	Reset to factory settings	
	Back to main menu	

(view with “Admin” authorization level)

5.2.6 Principle of controller entries

In the selection and entry menus there are icons displayed in the footers which you can use to take over the entry or cancel it.

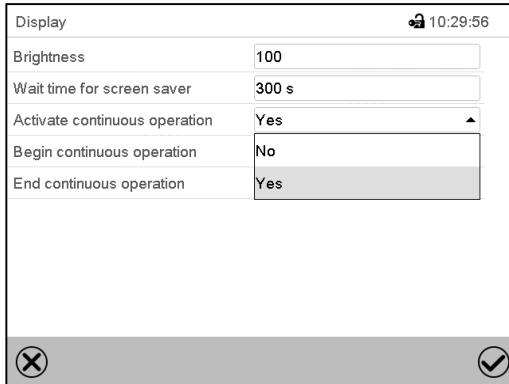

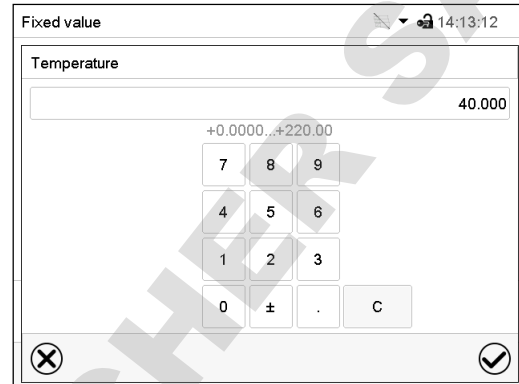

Selection menu (example)



Entry menu (example)

After completing the settings there are the following possibilities:

	Press the Confirm icon to take over the entries and exit the menu or continue the menu sequence.
	Press the Close icon to exit the menu or cancel the menu sequence without taking over the entries. When terminating a menu sequence, an information window appears, which must be confirmed.

5.3 Performance during and after power failures

During a power failure, all controller functions are shut down.

If there is a vacuum and ventilation is required during the duration of the power failure, this is possible via the emergency ventilation (chap. 6.4.3).

After the power returns, all functions return to the same status the chamber had before power failure.

	All settings and set point values remain in the memory during power failure.
---	--

- If the Standby mode had been activated prior to the power failure, the chamber remains off after the power returns. To operate it you must sign in with a higher authorization level and deactivate the standby mode.
- If the Standby mode had been deactivated prior to the power failure, operation continues after the power returns with previously entered parameters.

5.3.1 RD4 controller

After the power returns, the set-points are immediately resumed.

If during power failure an alarm has occurred (e.g., tolerance range, safety controller), confirm the alarm. See chap. 13.3.

5.3.2 MB2 controller

After the power returns, the controller continues to function in the original **operating mode** it was in previously before the power failure occurred:

- Performance after power failure in **Fixed value operation mode**
All functions return to the same status the chamber had before power failure. The set-points are immediately resumed.
- Performance after power failure during **Timer operation**
The set-points which had been active at the moment of program start are resumed. Program run continues.
- Performance after power failure during **Time program operation**
The program is resumed at the point where the interruption occurred with the latest set-points reached during the program run.
- Performance after power failure during **Week program operation**
The week program continues with the values corresponding to the current time.

Power failure and power return are noted in the **Event list** (chap. 10.2.5).

If during power failure an **alarm** has occurred (e.g., tolerance range, safety controller), confirm the alarm. See chap. 13.3.

6. Start up

With regard to operating the vacuum drying oven VD and the vacuum pump, please observe the DGUV guidelines 213-850 on safe working in laboratories, issued by the employers' liability insurance association (for Germany).

Note: Warming chambers may release odors in the first few days after commissioning. This is not a quality defect. To reduce odors quickly we recommend heating up the chamber to its nominal temperature for one day and in a well-ventilated location.

6.1 Condition after establishing the power connection

Prior to establishing the power connection, the following points must certainly be met:

- Installation of the chamber (chap. 4) performed in compliance with the installation guidelines and ambient conditions (cap. 3.4)
- Vacuum supply connected (chap. 4.3)
- If required: Inert gas connection established (chap. 4.5)

Establish the power connection: connect the power plug (chap. 4.6). Connect the power supply only when needed, and disconnect it when the chamber is not in use for an extended period.

MB2 controller: After establishing power supply the pilot lamp in the instrument panel shows readiness for operation.

The authorization level is "User". To be able to use the entire functionality of the controller (e.g., Settings menu functions, program functions, activating / deactivating Standby mode), log in with the desired authorization level.

All parameters, set-points and settings remain the same as before turning off.

- If the Standby mode had been activated prior to the power failure, the chamber remains off after the power returns. To operate it you must sign in with a higher authorization level and deactivate the standby mode.
- If the Standby mode had been deactivated prior to the power failure, operation continues after the power returns with previously entered parameters.

6.2 Standby mode: Turning on and off the vacuum drying oven

Activate the chamber only as required. Switch the chamber to standby mode when it is not in use.



All settings and setpoint values are saved after turning off the chamber.

If a program is running, it will be canceled by activating the standby mode

In Standby mode, the heating and the fan on the chamber rear are off, all valves are closed, and the socket for the pump in the pump module is de-energized. Heating control and pressure control are off.

To completely separate the chamber from the power supply, you must disconnect the power plug.

For decommissioning observe the guidelines in chap. 26.2.

6.2.1 RD4 controller

Activating / deactivating Standby mode via controller keyboard:

Deactivating Standby mode (turning on the chamber):

After establishing power supply, press down the **Standby** button for 5 seconds to **turn on** the chamber.

The controller shows normal display and controls temperature and pressure to the last entered values.

Activating Standby mode (turning off the chamber):

To turn off the chamber press down the **Standby button** for another 5 seconds.

Activating / deactivating Standby mode via controller menu:

Required access level: "User".

Path: **Normal display**  **Setpoints**    **Functions on/off**  **Standby**

Press the **OK button** to access the function "Standby".

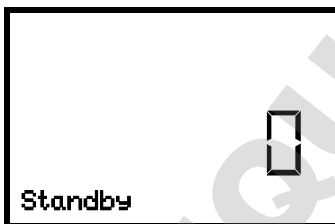

Function 1 "Standby".
The current switching state is shown (example).

Press the **OK button** to enable the setting.



Setting the function 1 "Standby".
The current setting flashes. Use the **arrow buttons** to select between "0" (Standby mode deactivated) and "1" (Standby mode activated).
Confirm the setting with the **OK button**.

With the **Back button** you can go back to the "**Functions on/off**" submenu and, repeatedly pressing it, to **Normal display**.

With setting "1" (Standby mode), the icon  is shown in Normal display.

When the controller display is dark in standby mode, press any button to activate it for 10 seconds.

6.2.2 MB2 controller

Required authorization: "Admin".

	Press the Setpoint setting icon to access the "Setpoint" setting menu from Normal display..
---	--

Path: **Setpoint > Fixed value operation setpoints > Functions on/off**

In this menu you can activate and deactivate the Standby mode .

Activating the Standby mode (turning off the chamber):

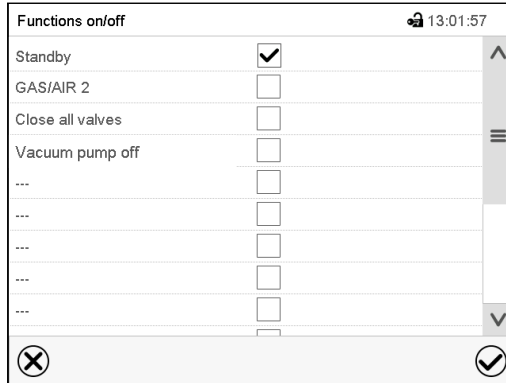

"Functions on/off" menu

Mark the checkbox of the function "Standby" to activate it and press the **Confirm** icon.

In the "Setpoints" menu press again the **Confirm** icon. The controller changes to Normal display.

	When the function "Standby" is activated, the "Standby" icon is displayed in the screen header in Normal display. Press the flash icon next to the information icon to display the corresponding text information "Standby" (information messages, chap. 13.1.2).
--	---

When the controller display is dark in standby mode, press on the touchscreen to activate it for 10 seconds.

Deactivating the Standby mode (turning on the chamber)

To deactivate the „Standby“ function, unmark the checkbox.

6.3 Controller settings upon start up

Depending on the functions activated in the controller, various settings can be requested directly after turning on the chamber.

Then you should assign a password for the operating level (chap. 9).

6.3.1 RD4 controller

If the function "Language selection at restart" has been activated (chap. 10.1.5, factory setting ON), the following settings are checked upon start up:

- **Menu language** (chap. 10.1.1):
Use the **arrow buttons** to select the desired language, confirm with the **OK button**
- **Temperature unit** (chap. 10.1.2):
Use the **arrow buttons** to select the desired temperature unit, confirm with the **OK button**
- **Current date** (chap. 10.1.3), format DD MM YYYY:
Use the **arrow buttons** to set the day, continue with the **OK button**.
Use the **arrow buttons** to set the month, continue with the **OK button**.
Use the **arrow buttons** to set the year, confirm with the **OK button**
- **Current time** (chap. 10.1.4), format HH:MM:
Use the **arrow buttons** to set the hours, continue with the **OK button**.
Use the **arrow buttons** to set the minutes, confirm with the **OK button**

6.3.2 MB2 controller

The window „Language selection“ enables the **language selection**, in case that it's activated in the "Start-up" menu. Afterwards occurs a request of the **time zone** and the **temperature unit**.

<div style="border: 1px solid black; padding: 5px;"> <p>Language selection</p> <p>German</p> <hr/> <p>English</p> <div style="text-align: right; margin-top: 10px;">✓</div> </div>	<div style="border: 1px solid black; padding: 5px;"> <p>Start-up</p> <p>Temperature unit: Degrees Celsius</p> <p>Time zone: UTC+1h (CET)</p> <p>Daylight saving time switch: Automatic</p> <p>▼ Start of daylight saving time</p> <p>▼ End of daylight saving time</p> <p>Language query after restart: Yes</p> <div style="display: flex; justify-content: space-between; margin-top: 10px;"> ✗ ✓ </div> </div>
--	--

The controller will function in the **operating mode**, which was active before the last shut-down. It controls temperature and pressure in fixed value operating mode to the last entered values and in the program mode to the set points achieved beforehand.

Locked operation

Fixed value		Setpoint	Actual value
Temperature	°C	40.0	40.1
Pressure	mbar	1100	1024

14:03:49

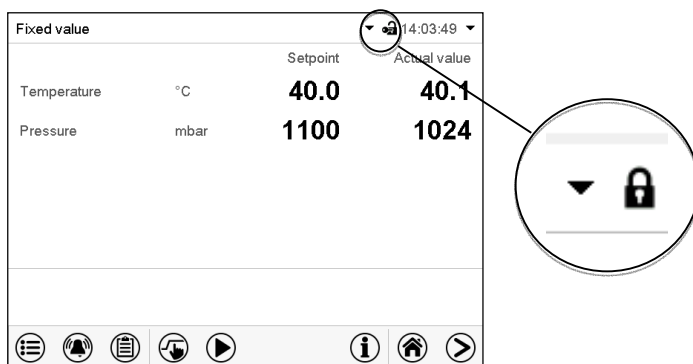
Provided that the user administration has been activated by the assignment of passwords for the different authorization types, the **controller operation** is first locked after turning on the unit, recognizable by the closed lock icon in the header.

In the locked view the controller provides all display functions. No setting functions are available.

The setpoints are shaded (light grey) in normal display. Changing them by direct entry in the fixed value operating mode is not possible. The functional icons for setpoint entry and program start in the footer are without function.

After turning on the unit, user log-in is required to operate the controller (chap. 9.2.2)

Operation without user log-in / without password-protection

If the password function has been deactivated, after turning on the unit without user log-in there are those controller functions available, which correspond to the highest authorization level without a password protection. There is no lock icon in the header.

6.4 Vacuum system

With regard to operation, please observe the DGUV guidelines 213-850 on safe working in laboratories, issued by the employers' liability insurance association (for Germany).

Starting situation: The vacuum source is connected and ready for operation.

For the pump module with chemical membrane pump option, see chap. 4.3.2.

6.4.1 Evacuation

Preparation:

- Make sure that the "Manual ventilation" plug (7) for emergency ventilation in case of a power failure, which is located on the chamber rear, is closed
- Pressure control must be activated.
- Turn on the vacuum pump. The pump shall continue running during the entire drying procedure.
- Set the desired pressure set-point on the controller (chap. 7).
- Monitor the internal pressure on the controller display

	As long as there is a vacuum, never try to open the oven by force.
---	--

6.4.2 Ventilation after completing the drying procedure (flooding with ambient air or inert gas)

The duration of the drying procedure can be determined via the pressure display on the controller. When the decreasing pressure reaches the set-point value, the drying process is completed. If the drying monitoring (section 8.7) is activated, a corresponding message is displayed.

To break the vacuum (ventilation) after completing the drying procedure, set the desired pressure set-point to atmospheric pressure (chap. 7). The ventilation valve opens, and ambient air or inert gas flow into the inner chamber.

Regularly the inert gas connection / ambient air inlet "GAS/AIR" (4) is used for ventilation

Chambers can be equipped as an option with an additional inert gas connection / ambient air inlet "GAS/AIR2" (5), which can be used alternatively. To do this, the controller function "GAS/AIR 2" serves to close the valve of the standard connection "GAS/AIR" (4). Then the valve of the optional connection "GAS/AIR 2" (5) is used for ventilation (chap. 8.3). This allows convenient switching when both connections are used differently (e.g., for inert gas and ambient air).

Ambient air is sucked in through the inert gas connection / ambient air inlet (4) or (5). The ambient air is introduced into the lower part of the rear panel of the inner chamber and is evenly distributed in the inner chamber. This supply of ambient air by under-flooding prevents turbulence of pulverized drying material.

6.4.3 Ventilation / breaking the vacuum in case of a power failure

To be able to open the chamber in case of a power failure, remove the "Manual ventilation" plug (7) for emergency ventilation, which is located on the chamber rear.



	As long as there is a vacuum, never try to open the oven by force.
--	--

	Make sure that the drying procedure is complete before breaking the vacuum. Otherwise, you should wait for the power to return to continue the drying procedure
---	---

6.4.4 Operation with inert gas

When operating the VD vacuum drying oven with inert gas, correctly follow the technical ventilation measures, as described in the DGUV guidelines 213-850 on safe working in laboratories, issued by the employers' liability insurance association (for Germany).

Inert gases in high concentrations are hazardous to health. They are colorless and almost odorless and therefore practically imperceptible. Inhalation of inert gases can cause drowsiness up to respiratory arrest. When the O₂ content of the air decreases below 18%, there is risk of death from lack of oxygen. Any gas that might escape has to be led out via good room ventilation or a suitable exhaust system.

	 DANGER
	<p>Danger of suffocation by high concentration of inert gas. Death by suffocation.</p> <ul style="list-style-type: none"> ⊘ Do NOT set up chambers in non-ventilated recesses. ➤ Ensure technical ventilation measures. ➤ Respect the relevant regulations for handling these gases. ➤ When decommissioning the vacuum drying oven, turn off the inert gas supply.

Install a pressure reducer for inert gas operation. Set the pressure reducer to a pressure slightly above ambient pressure. Ensure that the pressure reducer will open. Do not change this setting in order to avoid perturbation inside the oven and release of big quantities of inert gas after flooding the VD.

For ventilation an inert gas, e.g., nitrogen, is led into the inner chamber via the connection (4) or the optional connection (5), until pressure compensation with the atmosphere occurs. Depending on the individual application, you can perform a second evacuation and repeat the inert gas flooding.

When the inert gas fine dosing valve is open, a maximum of approx. 0.6 m³/h gas flows into the inner chamber. The introduction of inert gas by under-flooding in the lower region of the inner chamber rear wall and the extraction at the inner chamber ceiling allow an effective inert gas flushing.

 If the oven is charged to full capacity, depending on the load, deviations from the specified heating up times may occur.

7. Set-point entry

	Setting ranges	Control ranges
Temperature	0.0 °C / 32 °F up to 220.0 °C / 428 °F	10 °C / 18 °F above ambient temperature up to 220 °C / 428 °F
Pressure	0 mbar up to 1100 mbar	0 mbar up to 1100 mbar

7.1 RD4 controller

7.1.1 Temperature set-point entry

Required access level: "User".

Path: **Normal display**  **Setpoints**  **Temperature**

Press the **OK button** to enable the setting.

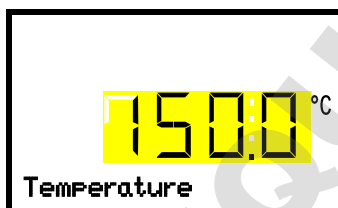

Temperature setting.
The current setting flashes. Enter the desired set-point with the **arrow buttons**.
Confirm the entry with the **OK button**.

With the **arrow-down button** you can continue with the pressure set-point entry (chap. 7.1.2).

With the **Back button** you can go back to the "**Setpoints**" submenu and, repeatedly pressing it, to **Normal display**.

 With safety controller mode "**Limit**", adapt the safety controller always when you changed the temperature set-point. Set the safety controller value by approx. 5 °C above the temperature set-point (chap. 11.2.2).
Recommended setting: safety controller mode "**Offset**" with safety controller value 5 °C.

7.1.2 Pressure set-point entry

Required access level: "User".

Path: **Normal display**  **Setpoints**   **Pressure**

Press the **OK button** to enable the setting.

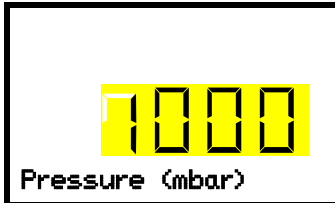

Pressure setting
The current setting flashes. Enter the desired set-point with the **arrow buttons**.
Confirm the entry with the **OK button**.

With the **arrow-up button** you can go back to the temperature set-point entry (chap. 7.1.1).

With the **arrow-down button** you can now change to the special controller functions setting (chap. 8).

With the **Back button** you can go back to the "**Setpoints**" submenu and, repeatedly pressing it, to **Normal display**.

7.2 MB2 controller

In Fixed value operating mode you can enter a temperature set-point, a pressure set-point, and the switching-state of special controller functions.

All settings made in Fixed value operating mode remain valid until the next manual change. They are saved also when turning off the chamber or in case of toggling to Program Mode.



The values entered in Fixed value mode become valid again after the end of a program and will then be targeted and equilibrated.



When operating without a vacuum by setting "Pressure control off" (chap. 8.6.2), the pressure tolerance range function is automatically deactivated.

7.2.1 Set-point entry through the "Setpoints" menu



Press the **Setpoint setting** icon to access the "Setpoint" setting menu from Normal display.

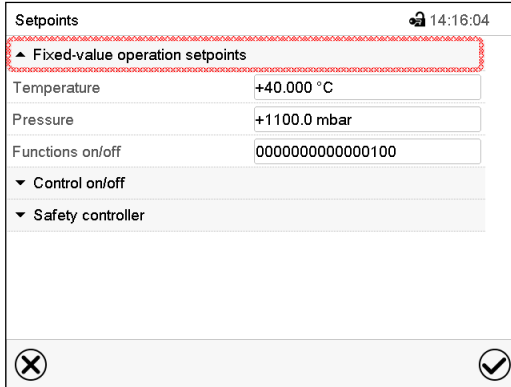

“Setpoints” menu.
Select “Fixed value operation setpoints” to access the individual parameters.

- Select the field “Temperature” and enter the desired temperature setpoint.
Confirm entry with **Confirm** icon.
- Select the field “Pressure” and enter the desired pressure setpoint.
Confirm entry with **Confirm** icon.

 When entering a value outside the setting range, the message: “Value outside of limits! (Min: xxx, Max: xxx)” appears (xxx is a wildcard for the limits of the respective parameter). Press the **Confirm** icon and repeat the entry with a correct value.

After completing the settings, press the **Confirm** icon to take over the entries and exit the menu, **or** press the **Close** icon to exit the menu without taking over the entries.

 With set-point type “Limit”, adapt the safety controller (chap. 11.2) always when you changed the temperature set-point. Set the safety controller set-point by approx. 5 °C above the controller temperature set-point.
Recommended setting: Set-point type “Offset” with safety controller set-point 5 °C.

7.2.2 Direct setpoint entry via Normal display

Alternatively you can also enter the setpoints directly via Normal display.

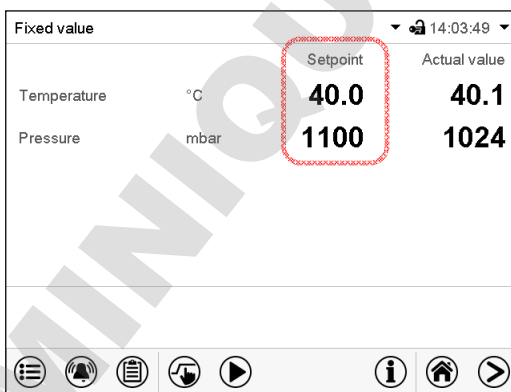

Normal display. Select the setpoint you want to change.

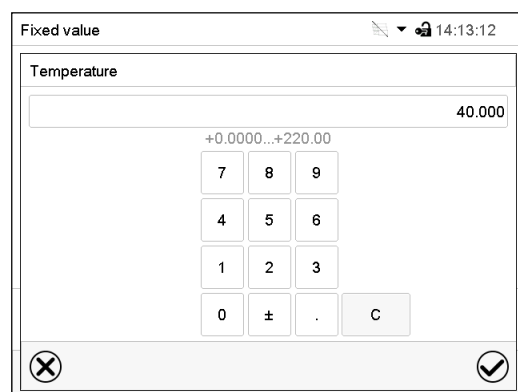

Example: “Temperature” entry menu. Enter the desired setpoint and confirm entry with **Confirm** icon.

8. Setting special controller functions

You can set the following functions via the controller menu:

- Activate / deactivate the Standby mode (chap. 6.2)
- Turning off the vacuum pump via the socket on the pump module (chap. 8.2)
- Use the optional connection "GAS/AIR2" (5) for ventilation (chap. 8.3)
- Close all existing fine dosing valves (chap. 8.4)
- Turning on / off temperature control (chap. 8.5)
- Turning on / off pressure control (chap. 8.6)
- Starting / terminating the drying monitoring (chap. 8.7)

8.1 Menu structure

8.1.1 RD4 controller

Required access level: "User".

8.1.1.1 "Functions on/off" menu

In the "Functions on/off" menu you can define the switching state of three special controller functions.

Path: **Normal display**  **Setpoints**    **Functions on/off**

The functions are displayed from left to right.

Example: Function 1 activated = 1000. Function 1 deactivated = 0000.

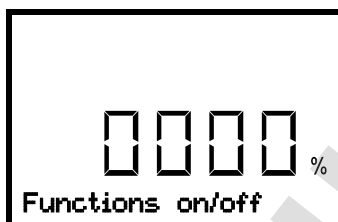

Submenu "Functions on/off".

This view shows the switching states four functions. Functions 1, 2, and 3 are available with the present chamber type.

"1" = Function activated

"0" = Function deactivated

Press the **OK button** to access the first individual function. With the **arrow-down button** you can proceed to the subsequent functions.

- Function 1 "Standby" (chap. 6.2)
- Function 2 "GAS/AIR 2" (chap. 8.3)
- Function 3 "Close all valves" (chap. 8.4)
- Function 4 "Vacuum pump off" (chap. 8.2)

Press the **OK button** to enable the setting of the desired function and select the function's switching state "1" (function activated) or "0" (function deactivated).

With the **Back button** you can go back to the "Setpoints" submenu and, repeatedly pressing it, to **Normal display**.

In Normal display the activated functions are indicated by an icon showing the number of the respective function. If several functions are simultaneously active, the icon displays a combination of the corresponding numbers, e.g. 

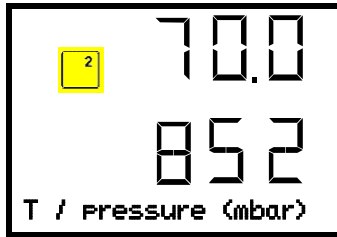

Example:
Normal display with activated function 2 "GAS/AIR 2"

8.1.1.2 Quick Access menu

More functions are available via the **Quick Access menu**:

Path: **Normal display**  **Pressure control**

- Function "Temperature control" (chap. 8.5)
- Function "Pressure control" (chap. 8.6)
- Function "Drying monitoring" (chap. 8.7)

When temperature control and / or pressure control are deactivated, the "Info" icon flashes slowly. While it is lit, the corresponding information is shown in the bottom text line.

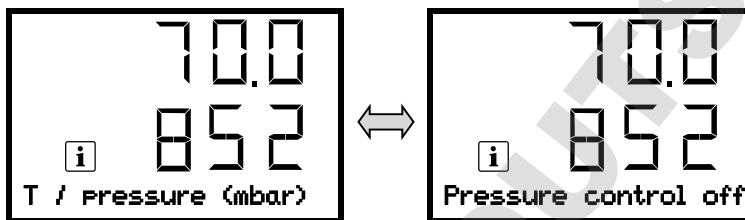

If there are several information messages, they are shown one after the other.

8.1.2 MB2 controller

Required authorization: "Admin".

8.1.2.1 "Functions on/off" menu

This chapter describes the setting with operating mode Fixed value operation. Settings for program operation are described in chap. 16.7.3 (time programs) and chap. 17.6.5 (week programs).

In the "**Functions on/off**" menu you can define the switching state of three controller functions.

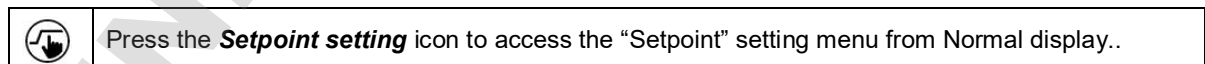

Path: **Setpoint > Fixed value operation setpoints > Functions on/off**

- Function “Standby” (chap. 6.2)
- Function “GAS/AIR 2” (chap. 8.3)
- Function “Close all valves” (chap. 8.4)
- Function “Vacuum pump off” (chap. 8.2)

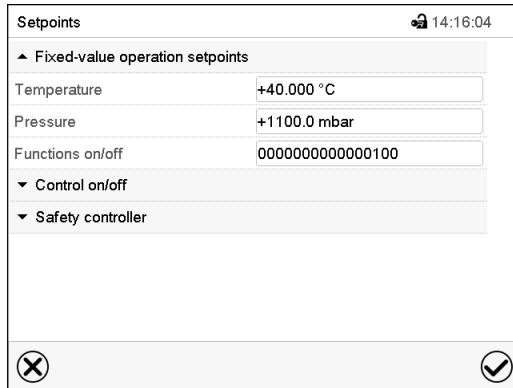

“Setpoints” menu.

Select the field “Functions on/off”.

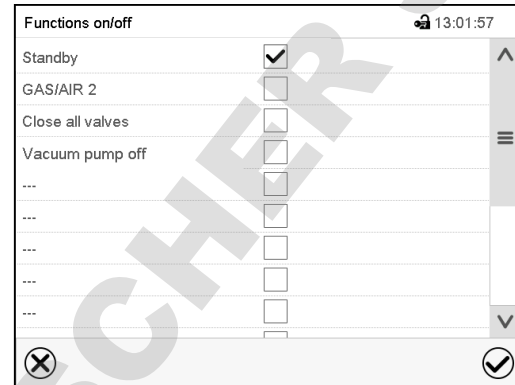

“Functions on/off” entry menu.

Mark / unmark the checkbox to activate / deactivate the desired function and press the **Confirm** icon

The functions are displayed from right to left.

Activated function: switching status “1” (On)

Deactivated function: switching status “0” (Off)

Example:

Activated operation line “Standby” = 0000000000000001

Deactivated operation line “Standby” = 0000000000000000

DOMINIQUE BOUTCHER SAS

8.1.2.2 “Control on/off” menu

More functions are available via the “Control on/off” menu.

	Press the Setpoint setting icon to access the “Setpoint” setting menu from Normal display..
--	--

Path: **Setpoint > Control on/off**

- Function “Temperature” (temperature control, chap. 8.5)
- Function “Pressure” (pressure control, chap. 8.6)

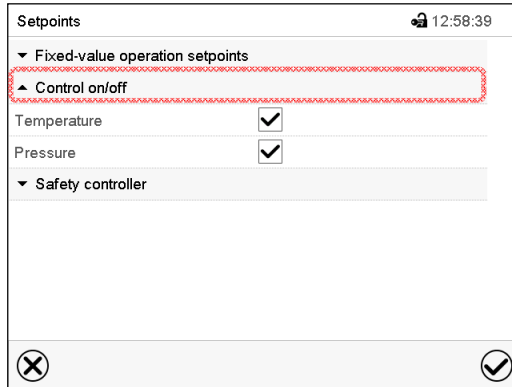

“Setpoints” menu.

Select the field “Control on/off”.

Mark / unmark the checkbox to activate / deactivate the desired function and press the **Confirm** icon

8.2 Turning off the vacuum pump via the socket on the pump module

Function “Vacuum pump off” serves to turn off the vacuum pump via the socket on the pump module.

8.2.1 RD4 controller

Required access level: “User”.

Path: **Normal display** **Setpoints** **Functions on/off** **vacuum pump off**

Press the **OK button** to access the function “Vacuum pump off”.

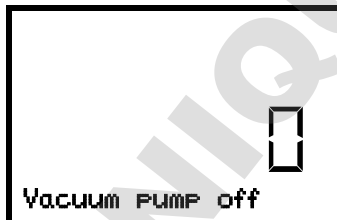

Function 1 “Vacuum pump off”.

The current switching state is shown (example).

Press the **OK button** to enable the setting.

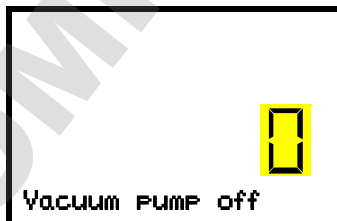

Setting the function 1 “Vacuum pump off”.

The current setting flashes. Use the **arrow buttons** to select between 0 (no shutdown) and 1 (pump deactivated).

Confirm the setting with the **OK button**.

With the **Back button** you can go back to the “**Functions on/off**” submenu and, repeatedly pressing it, to **Normal display**.

With setting “1” (pump turned off) the icon is shown in Normal display.

8.2.2 MB2 controller



Press the **Setpoint setting** icon to access the “Setpoint” setting menu from Normal display..

Path: **Setpoint > Fixed value operation setpoints > Functions on/off**

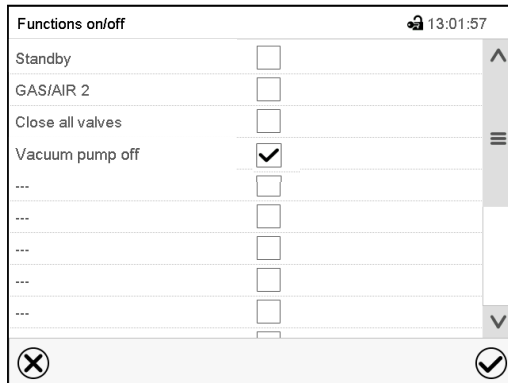

“Functions on/off” menu.

Mark the checkbox of the function “Vacuum pump off” to activate it and press the **Confirm** icon.

In the “Setpoints” menu press again the **Confirm** icon. The controller changes to Normal display.



When the function “Vacuum pump off” is activated, the “Vacuum pump off” icon is displayed in the screen header in Normal display. Press the flash icon next to the information icon to display the corresponding text information “Vacuum pump off” (information messages, chap. 13.1.2)

8.3 Using the optional universal connection “GAS/AIR 2” for ventilation

Regularly the universal connection for inert gas / ambient air „GAS/AIR“ (4) is used for ventilation.

The “GAS/AIR 2” function serves to close the valve of the standard connection „GAS/AIR“ (4) and activate the valve of the optional universal connection “GAS/AIR 2” (5), which is then used for ventilation

This allows convenient switching when both connections are used differently (e.g., for inert gas and ambient air).



If you activate the “GAS/AIR 2” function on a chamber, which is NOT equipped with the universal connection for inert gas / ambient air “GAS/AIR 2” (5), ventilation is no longer possible!

8.3.1 RD4 controller

Path: **Normal display** **Setpoints** **Functions on/off** **GAS/AIR 2**

Press the **OK button** to access the function "GAS/AIR 2".

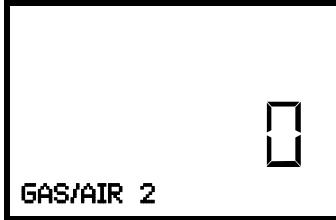

Function 2 "GAS/AIR 2".
The current switching state is shown (example).

Press the **OK button** to enable the setting.



Setting the function 2 "GAS/AIR 2".
The current setting flashes. Use the **arrow buttons** to select between "0" (Use valve for connection "GAS/AIR") and "1" (Use valve for connection "GAS/AIR 2").
Confirm the setting with the **OK button**.

With the **Back button** you can go back to the "Functions on/off" submenu and, repeatedly pressing it, to **Normal display**.

With setting "1" (closed valve of the standard connection "GAS/AIR" (4), active valve of the optional connection "GAS/AIR 2" (5) the icon is shown in Normal display.

8.3.2 MB2 controller

Press the **Setpoint setting** icon to access the "Setpoint" setting menu from Normal display..

Path: **Setpoint > Fixed value operation setpoints > Functions on/off**

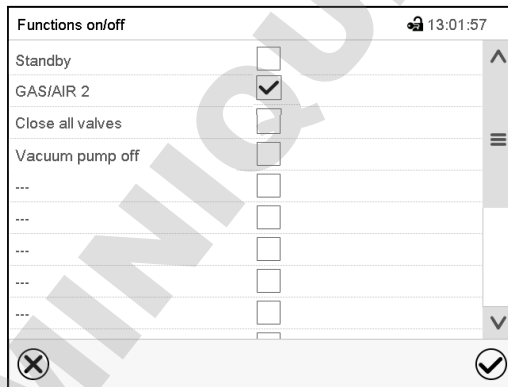

"Functions on/off" menu.
Mark the checkbox of the function "GAS/AIR 2" to activate it and press the **Confirm** icon.
In the "Setpoints" menu press again the **Confirm** icon.
The controller changes to Normal display.

GAS AIR 2 When the function "GAS/AIR 2" is activated, the "GAS/AIR 2" icon is displayed in the screen header in Normal display. Press the flash icon next to the information icon to display the corresponding text information "GAS/AIR 2" (information messages, chap. 13.1.2)

8.4 Close all valves

Close all existing fine dosing valves

8.4.1 RD4 controller

Path: **Normal display**  **Setpoints**    **Functions on/off**    **Close all valves**

Press the **OK button** to access the function “Close all valves”.



Function 3 “Close all valves”.
The current switching state is shown (example).

Press the **OK button** to enable the setting.

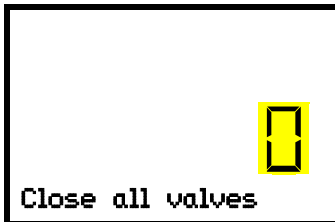

Setting the function 3 “Close all valves”.
The current setting flashes. Use the **arrow buttons** to select between “0” (valves in use) and “1” (valves closed).
Confirm the setting with the **OK button**.

With the **Back button** you can go back to the “**Functions on/off**” submenu and, repeatedly pressing it, to **Normal display**.

With setting “1” (all valves closed), the icon  is shown in Normal display

8.4.2 MB2 controller

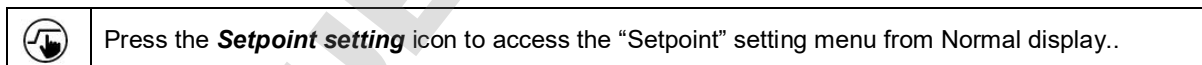

Press the **Setpoint setting** icon to access the “Setpoint” setting menu from Normal display..

Path: **Setpoint > Fixed value operation setpoints > Functions on/off**

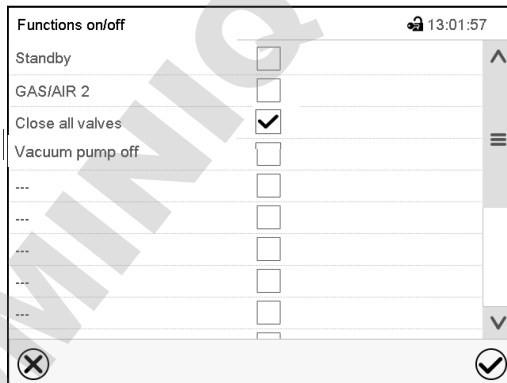

“Functions on/off” menu.

Mark the checkbox of the function “Close all valves” to activate it and press the **Confirm** icon.

In the “Setpoints” menu press again the **Confirm** icon.
The controller changes to Normal display.

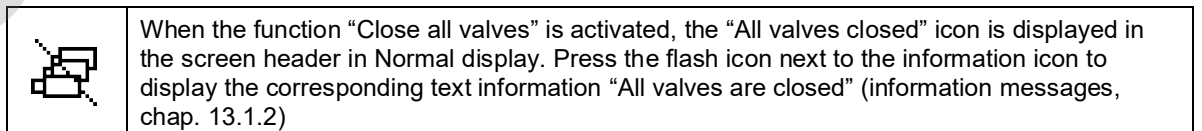

When the function “Close all valves” is activated, the “All valves closed” icon is displayed in the screen header in Normal display. Press the flash icon next to the information icon to display the corresponding text information “All valves are closed” (information messages, chap. 13.1.2)

8.5 Activating / deactivating temperature control

8.5.1 RD4 controller

Path: **Normal display**   **Temperature control**

Press the **OK button** to enable the setting.

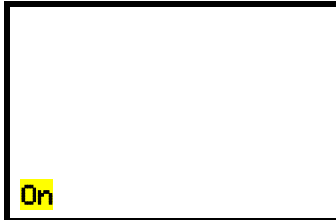

Setting the “Temperature control” function.
Use the **arrow buttons** to select between “On” (temperature control active) and “Off” (temperature control deactivated).
Confirm the setting with the **OK button**.

After confirming with the **OK button** or with the **Back button** you go back to **Normal display**.

If the setting “Off” (temperature control deactivated) has been selected, the information message “Temperature control off” is displayed. The „Info“ icon flashes slowly.

The actual temperature value continues to be displayed in Normal display.

8.5.2 MB2 controller

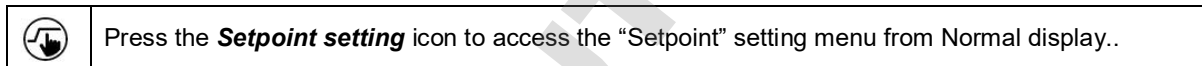

Path: **Setpoint > Control on/off**

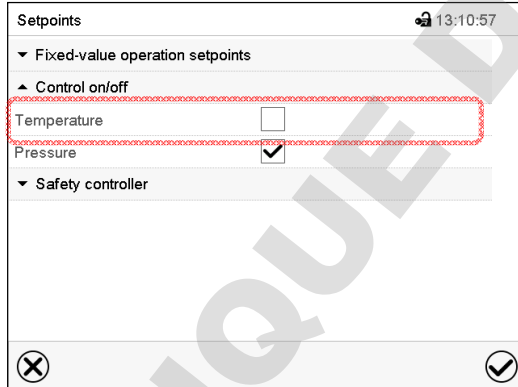

“Setpoints” menu.

Select the field “Control on/off” (example: deactivated temperature control).

Mark / unmark the “Temperature” checkbox to activate / deactivate temperature control and press the **Confirm** icon.

- Checkbox marked: temperature control active
- Checkbox unmarked: temperature control deactivated

The actual temperature value continues to be displayed in Normal display:

Fixed value		GAS AIR 10:13:57	
		Setpoint	Actual value
Temperature	°C	-----	41.0
Pressure	mbar	1100	1024

Normal display with deactivated temperature control.

8.6 Activating / deactivating pressure control

When operating the chamber without a vacuum connection, you can deactivate pressure control with the to avoid alarms of the pressure system. No pressure tolerance range alarms and no pressure alarm will be emitted.

Evacuation and ventilation are then no longer possible.

8.6.1 RD4 controller

Path: **Normal display**  **Pressure control**

Press the **OK button** to enable the setting.

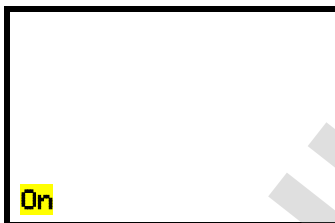

Setting the "Pressure control" function.

Use the **arrow buttons** to select between "On" (pressure control active) and "Off" (pressure control deactivated).

Confirm the setting with the **OK button**.

After confirming with the **OK button** or with the **Back button** you go back to **Normal display**.

If the setting "Off" (pressure control deactivated) has been selected, the information message "Pressure control off" is displayed. The „Info“ icon flashes slowly.

The actual pressure value continues to be displayed in Normal display.

8.6.2 MB2 controller

 Press the **Setpoint setting** icon to access the “Setpoint” setting menu from Normal display..

Path: **Setpoint > Control on/off**

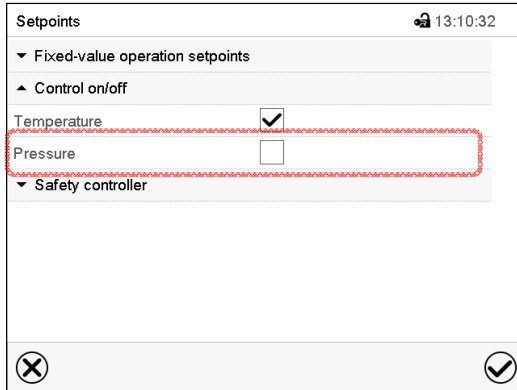

“Setpoints” menu.

Select the field “Control on/off” (example: deactivated pressure control).

Mark / unmark the “Pressure” checkbox to activate / deactivate pressure control and press the **Confirm** icon

- Checkbox marked: pressure control active
- Checkbox unmarked: pressure control deactivated

The actual pressure value continues to be displayed in Normal display:

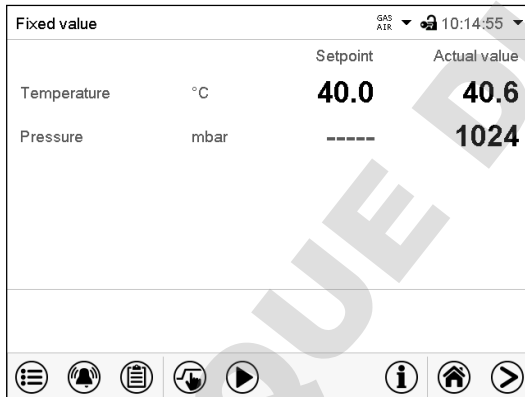

Normal display with deactivated pressure control.

8.7 Drying monitoring

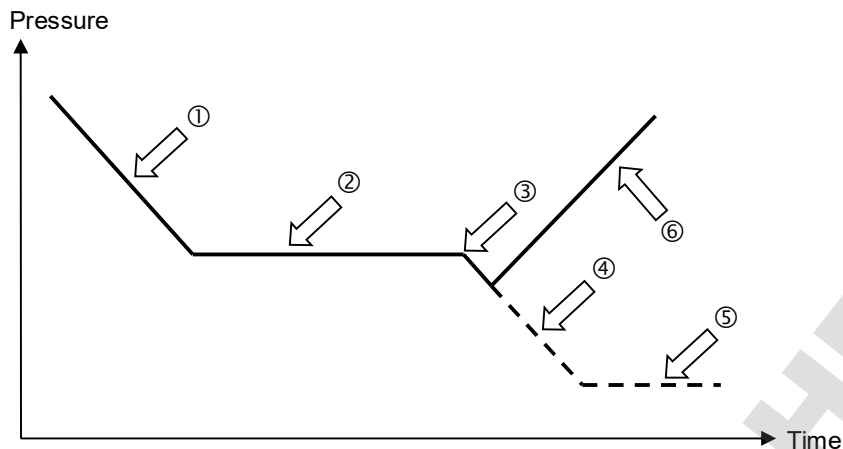

Figure 19: Schematic timing of the drying process and drying monitoring

Procedure:

- Enter the temperature set-point.
The previously entered pressure setpoint is not used with this function. It remains saved.
The drying monitoring uses a fixed minimum pressure setpoint.
- Start the drying monitoring: the vacuum pump is activated, the evacuation valve opens.
Starting from ambient pressure, the pressure starts to decrease. ①
- Depending on the vapor pressure of the solvent, a plateau phase is then reached ② during which the solvent vaporizes. The pressure remains almost constant.
- After the solvent is completely evaporated, drying is complete. ③ The pressure starts to decrease again
Without drying monitoring the pressure would now continue to decrease ④, until the maximum final vacuum is reached. ⑤
- The drying monitoring recognizes this second pressure drop. It turns off the pressure control. The chamber will then be ventilated automatically. ⑥

Prior to starting a new drying process, the pressure control must be activated again (chap. 8.5).

Notes:

If the drying monitoring is aborted during phase ① or ②, the controller will take the current actual pressure value as the pressure setpoint. This overwrites the previously entered pressure setpoint. It can be changed manually at any time.

In processes with low temperatures <math><40\text{ }^{\circ}\text{C}</math> or thermally poorly coupled items to be dried (e.g. drying of powders), the drying monitoring may incorrectly identify the relevant parameters. In this case, please check the process result and, if necessary, use a process not including this program for such processes.

8.7.1 RD4 controller

Path: **Normal display**    **Drying monitoring**

Press the **OK button** to enable the setting.

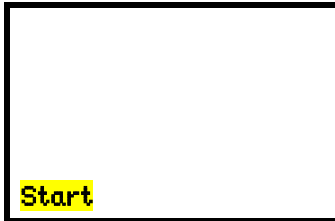

Setting the function "Drying monitoring".
Use the **arrow buttons** to select between "Start" (start drying monitoring) and "Cancel" (terminate drying monitoring).
Confirm the setting with the **OK button**.

After confirming with the **OK button** or with the **Back button** you go back to **Normal display**. The drying process starts.

8.7.2 MB2 controller

 In Normal display press the **Program start** icon to access the "Program start" menu.

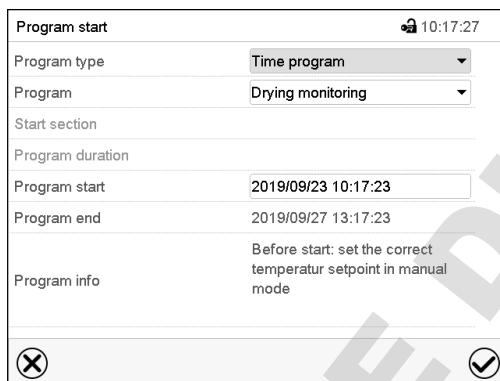

"Program start" menu with the selected Drying monitoring program.

- In the field "Program" select the setting "Drying monitoring" program.
- Select the field "Program start" and enter the desired program start time in the "Program start" entry menu. Press the **Confirm** icon. The program delay time until program start begins. The program end is calculated automatically.

After completing the settings, press the **Confirm** icon to take over the entries and exit the menu. The program starts running.

If instead you press the **Close** icon to exit the menu without taking over the entries, the program will not start.

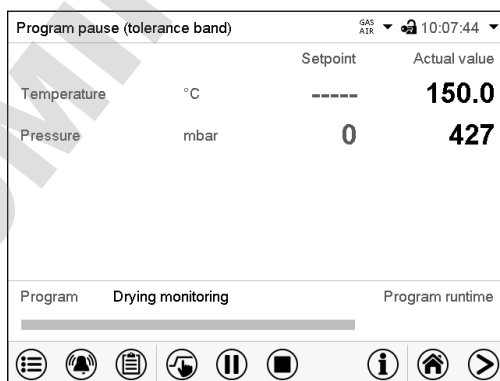

Normal display. Information on the bottom of the screen indicates the currently running program and the time already passed. The grey bar shows how much time of the whole time is elapsed.

9. Authorization levels and password protection

9.1 RD4 controller

9.1.1 Password request

To access menus for which access is restricted, you must enter the corresponding password.

After calling the appropriate menu function with the **OK button** the password request appears.

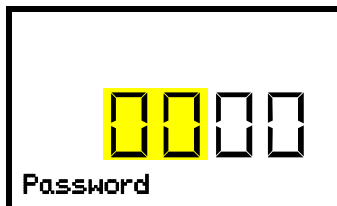

Password request.

The left two digits are flashing. Enter the desired numbers with the **arrow buttons**.

Confirm the setting with the **OK button**.

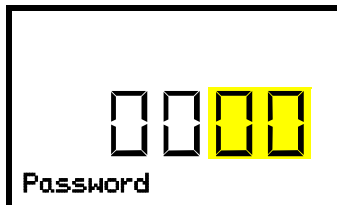

Password request.

The right two digits are flashing. Enter the desired numbers with the **arrow buttons**.

Confirm the setting with the **OK button**.

Upon entering an incorrect password, the message "Wrong password" is displayed.

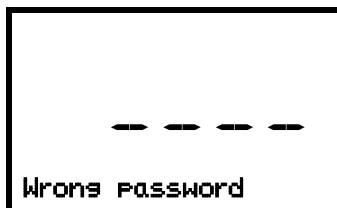

Display "Wrong password".

After 3 seconds the controller changes again to the password entry.

Enter the correct password.

Following correct password entry you can access the desired menu function.

9.1.2 Assign and modify a password

In this menu you can assign and modify the passwords of the "User" and "Admin" access levels.

Required access level: "Admin".

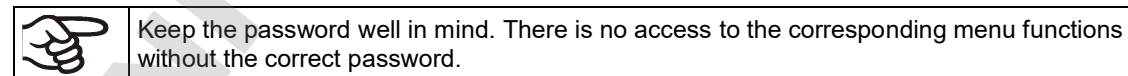

9.1.2.1 Assign and modify the User password

Path: **Normal display** ▾ ▾ ▾ ▾ **Settings** **Chamber** ▾ ▾ ▾ ▾ **Password User**

Press the **OK button** to enable the setting.

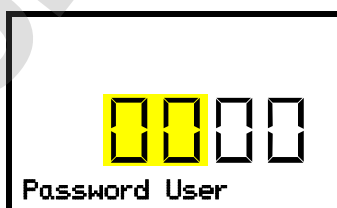

Setting the User password.

The left two digits are flashing. Enter the desired numbers with the **arrow buttons**.

Confirm the setting with the **OK button**.

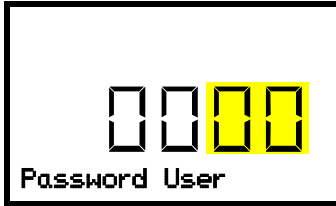

Setting the User password.
The right two digits are flashing. Enter the desired numbers with the **arrow buttons**.
Confirm the setting with the **OK button**.

With the **arrow-down button** you can now proceed to enter the Admin password.

With the **Back button** you can go back to the “Chamber” submenu and, repeatedly pressing it, to **Normal display**.

9.1.2.2 Assign and modify the Admin password

Path: **Normal display** ▾ ▾ ▾ ▾ **Settings** **Chamber** ▾ ▾ ▾ ▾ ▾ **Password Admin**

Press the **OK button** to enable the setting.

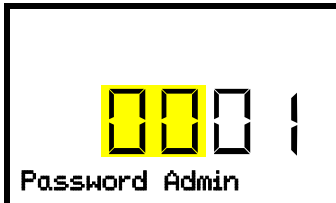

Setting the Admin password.
The left two digits are flashing. Enter the desired numbers with the **arrow buttons**.
Confirm the setting with the **OK button**.



Setting the Admin password.
The right two digits are flashing. Enter the desired numbers with the **arrow buttons**.
Confirm the setting with the **OK button**.

With the **Back button** you can go back to the “Chamber” submenu and, repeatedly pressing it, to **Normal display**.

9.2 MB2 controller

9.2.1 User management, authorization levels and password protection

The available functions depend on the current authorization level "Master", "Service", "Admin" or "User".

The authorization levels are hierarchical: Every authorization includes all functions of the next lower level.

"Master" authorization level

- Highest authorization level, only for developers
- Extensive authorization for controller operation and configuration, outputs/inputs, alarm settings, parameter sets and operating ring display
- All passwords can be changed in the "log out" submenu (chap. 9.2.3).

"Service" authorization level

- Authorization level only for BINDER service
- Extensive authorization for controller operation and configuration, access to service data
- The passwords for "Service", "Admin" and "User" authorization levels can be changed in the "log out" submenu (chap. 9.2.3).

"Admin" authorization level

- Expert authorization level, for the administrator
- Authorization for controller configuration and network settings and for operating those controller functions required for operating the chamber. Restricted access to service data.
- Password (factory setting): "2".
- The passwords for "Admin" and "User" authorization levels can be changed in the "log out" submenu (chap. 9.2.3).

"User" authorization level

- Standard authorization level for the chamber operator
- Authorization for operating the controller functions required for operating the chamber.
- No authorization for controller configuration and network settings. The "Settings" and "Service" submenus of the main menu are not available.
- Password (factory setting): "1"
- The password for the "User" authorization level can be changed in the "log out" submenu (chap. 9.2.3).

As soon as a password has been assigned for an authorization level, the access to this level and the related controller functions are only available after log-in with the appropriate password.

If for an authorization level no password is assigned, the related controller functions of this level are available for every user without login.

If passwords have been assigned for all authorization levels, access to the controller functions is locked without login.

Operation after user login

At user login, the authorization level is selected and confirmed by entering the respective password.

Following user login, controller operation is available, recognizable by the open-lock icon in the header. The available controller functions correspond to the user's authorization level.

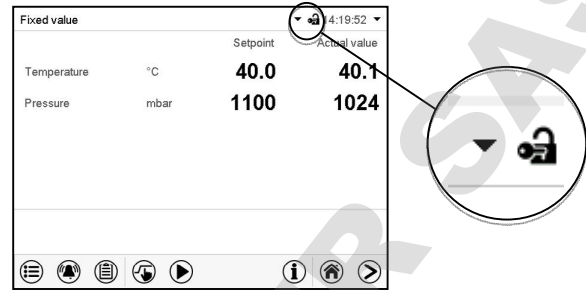

Password protection activated for all levels: operation without user login is locked

If passwords have been assigned for all authorization levels, the controller is locked without registration of a user.

As long as no user is registered, controller operation is locked, recognizable at the closed-lock icon in the header. This requires that the user management has been activated by the assignment of passwords for the individual authorization levels.

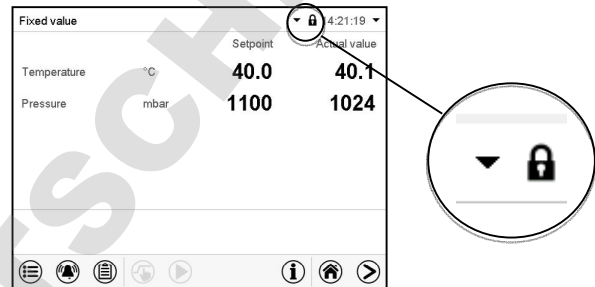

Password protection for at least one level deactivated: operation without user login is possible

If passwords have not been assigned for all authorization levels, after turning on the chamber there are those controller functions available, which correspond to the highest authorization level without password protection.

No lock icon is shown in the display header.

User login is neither required nor possible.

To activate the password protection and user login, perform new password assignment (chap. 9.2.5.3).

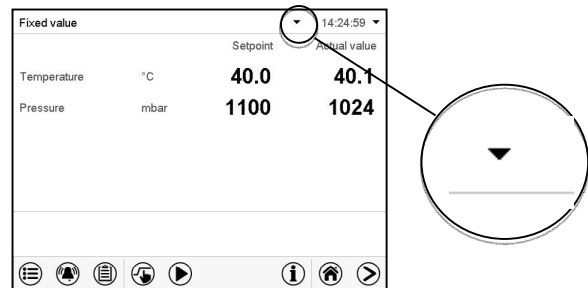



Information window

To check the authorization level of the user currently logged-in, select in Normal display the arrow far right in the display header.

Fixed value		Setpoint	Actual value
Temperature	°C	40.0	40.0

The information window shows date and time, the controller's free memory space and under "Authorization" the authorization level of the current user.

If passwords have been assigned for all authorization levels, a user without login (password entry) has no authorization. There are only viewing functions available.

Fixed value			
 Tuesday, 2016/05/24	 14:32:10		
 Authorization:	 Free storage: 98%		

Display when all authorization levels are password protected and no user has logged in:

No authorization level is displayed.

If passwords have been assigned only for some of the authorization levels, a user without login (password entry) has access to the functions of the highest authorization level without password protection.

Fixed value			
 Tuesday, 2016/05/24	 14:29:26		
 Authorization: Admin	 Free storage: 98%		

Display when only some of the authorization levels are password protected (example: no protection for the "User" and "Admin" levels) and no user has logged in:

The user's effective authorization (due to lack of password protection) is shown.

Example: user with "Admin" authorization.

If passwords have been assigned for some or all of the authorization levels, user login (password entry) provides the authorization for the corresponding password-protected level.

Fixed value			
 Tuesday, 2016/05/24	 14:29:26		
 Authorization: Admin	 Free storage: 98%		

Display when at least some of the authorization levels are password protected and a user has logged in.

The user's authorization (by password entry) is shown.

Example: user with "Admin" authorization.

9.2.2 Log in

Path: *Main menu > User > Log in*

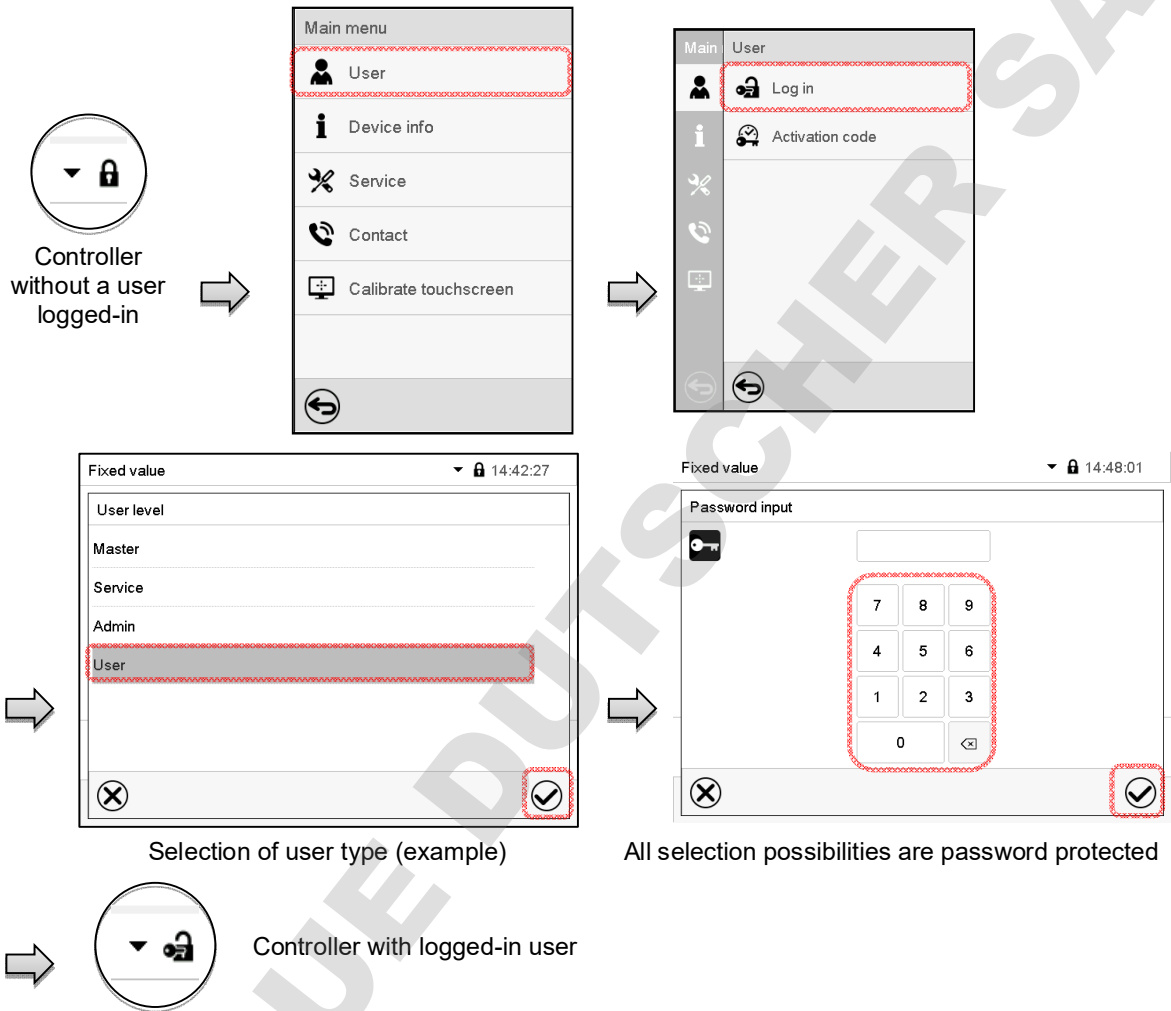

After completing the settings, press the **Confirm** icon to take over the entries and exit the menu, or press the **Close** icon to exit the menu without taking over the entries.

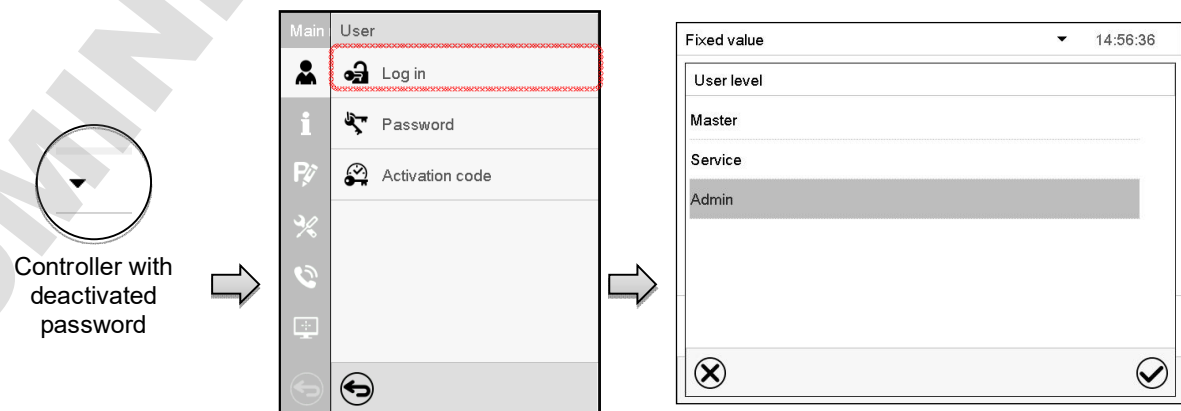

9.2.3 Log out

Path: *Main menu > User > Log out*

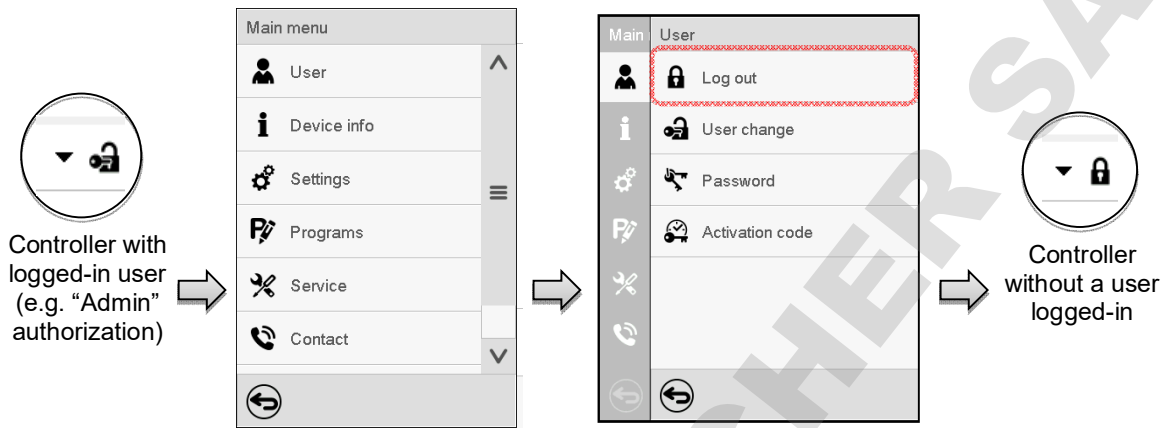

9.2.4 User change

If the password function has been deactivated (chap.9.2.5.2) this function is not available.

Path: *Main menu > User > User change*

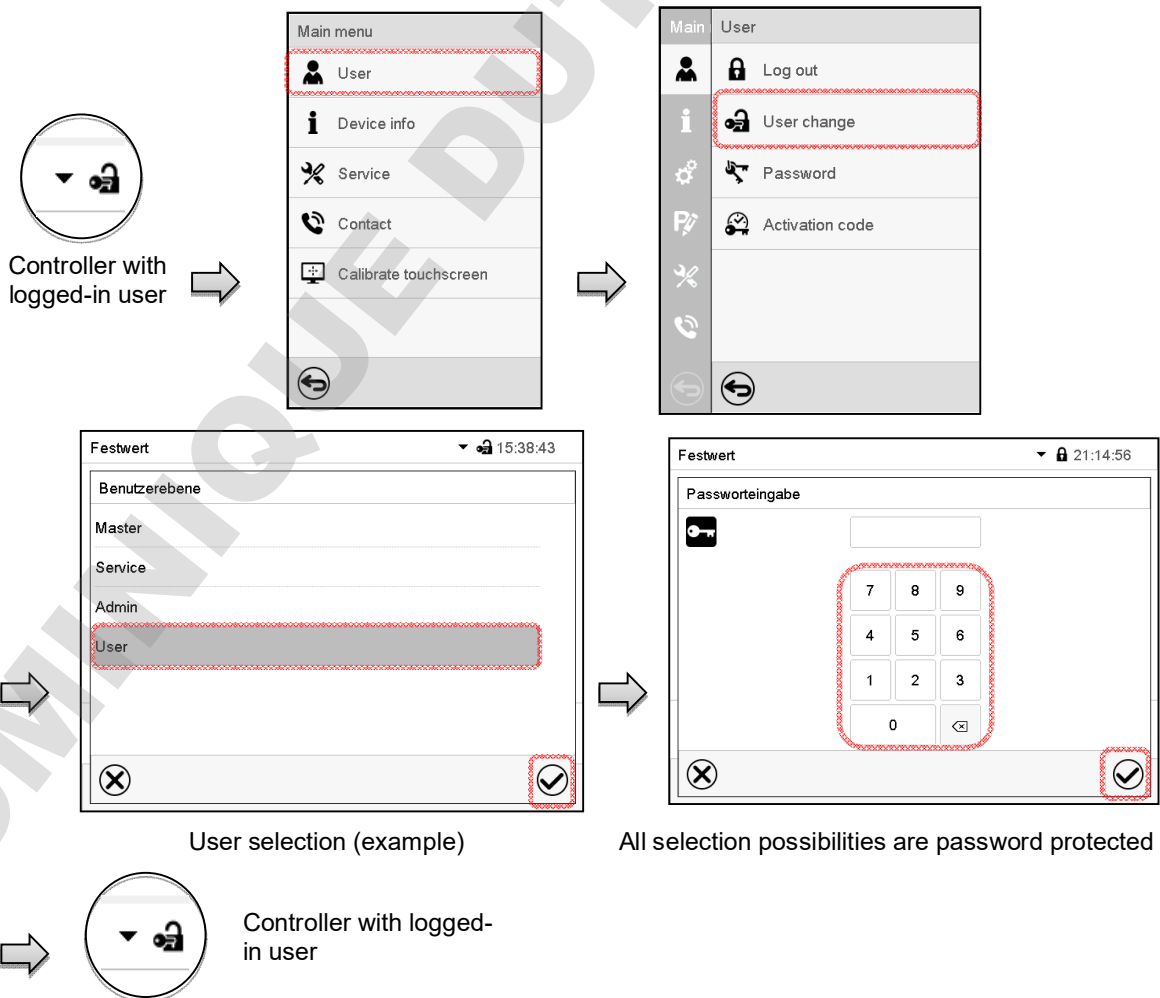

9.2.5 Password assignment and password change

This function is not available for a user logged-in with "User" authorization.

9.2.5.1 Password change

A logged-in user can change the passwords of his current level and of the next lower level(s).

Example: A user with "Admin" authorization can change the passwords for the "Admin" and "User" authorization levels.

Path: *Main menu > User > Password*

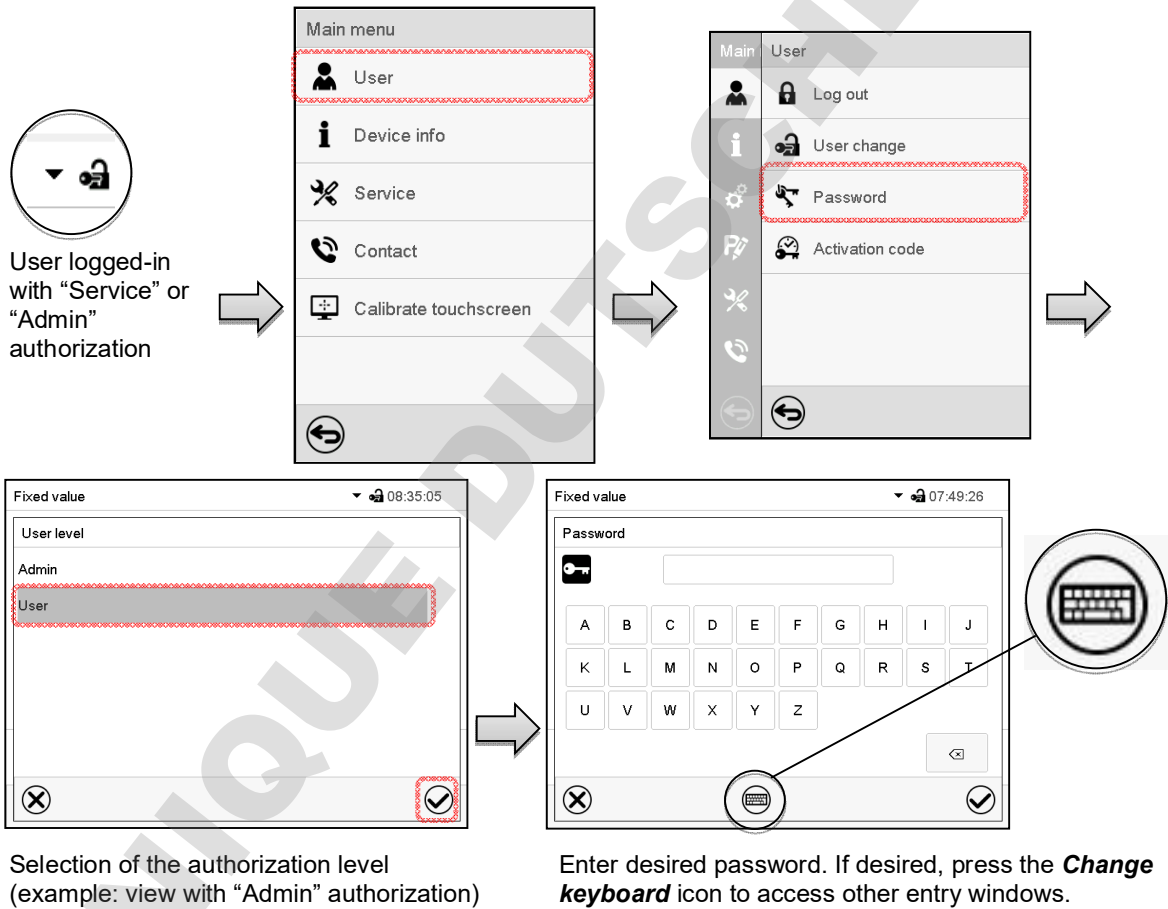

In the “Keyboard switch” window you can select different keyboards to enter uppercase and lowercase letters, digits, and special characters. All types of characters can be combined within one single password.

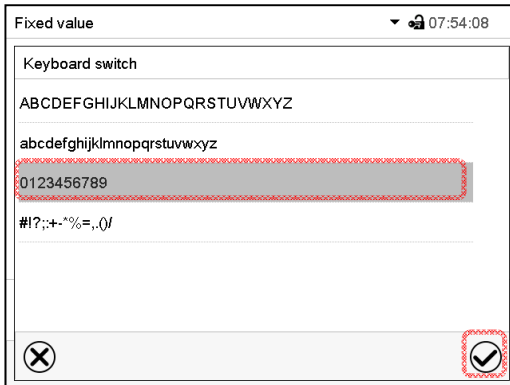

Example: access the digit entry window

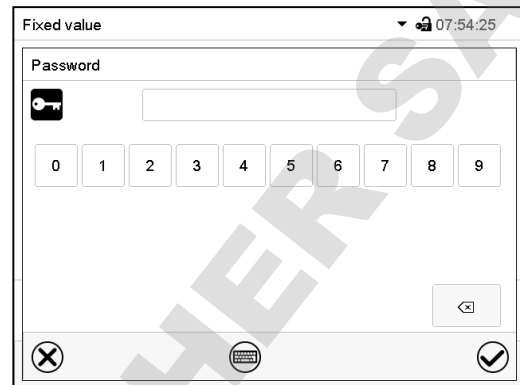

Entry of digits

To confirm the entry, press the **Confirm** icon.

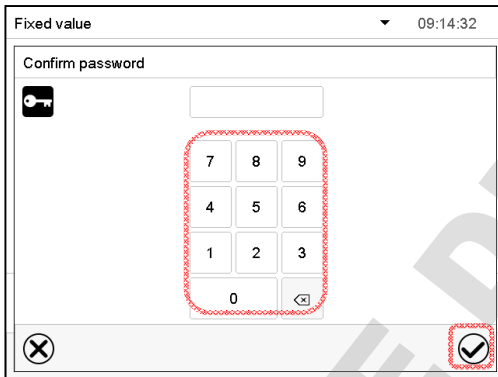

Repeat the password entry for confirmation (sample picture). For each character of the password, the required keyboard appears automatically. Then press the **Confirm** icon.

9.2.5.2 Deleting the password for an individual authorization level

A user logged-in with “Service” or “Admin” authorization can delete the passwords of his current level and of the next lower level(s). To do this no password is entered during a password change.

Path: *Main menu > User > Password*

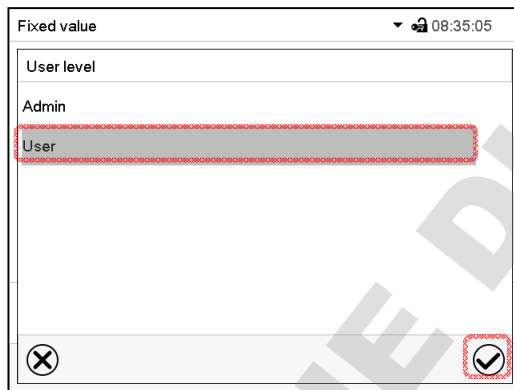
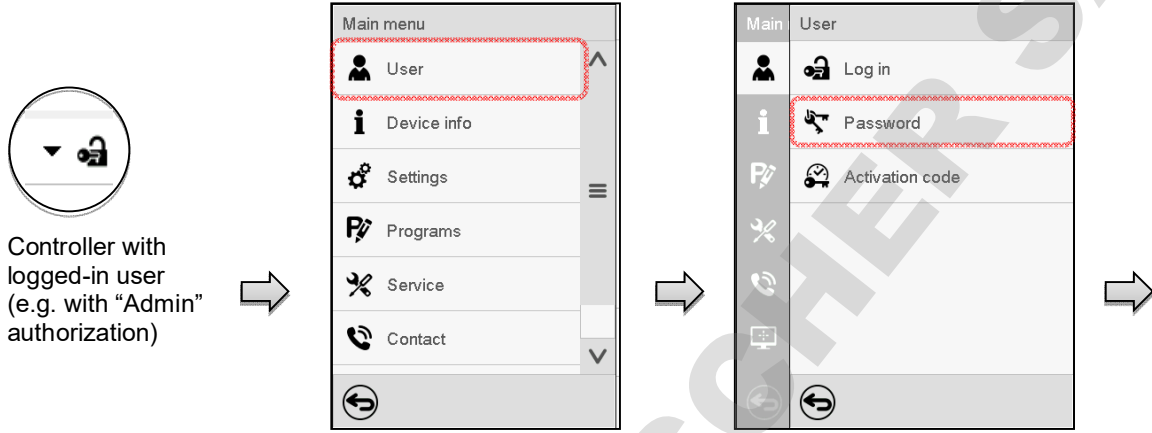

Select the authorization level for which the password shall be deleted.

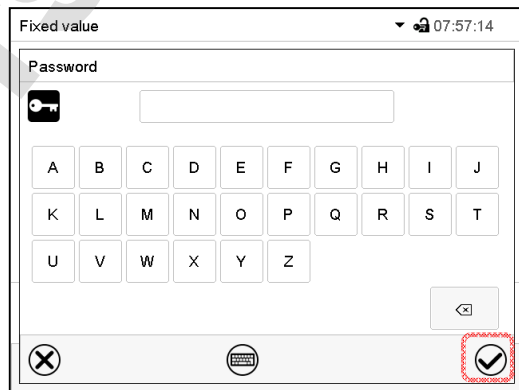

Do NOT enter anything in the “Password” screen. Press the **Confirm** icon.

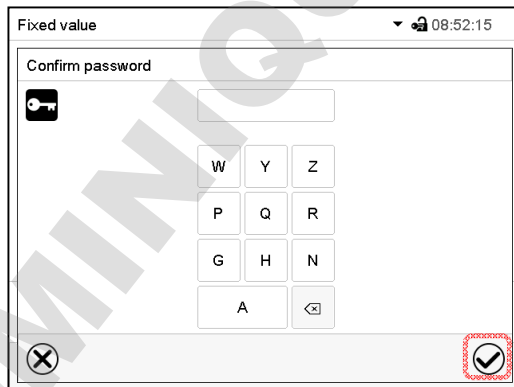

Do NOT enter anything in the “Confirm password” screen. Press the **Confirm** icon.

The password is deleted.

9.2.5.3 New password assignment for “service” or “admin” authorization level when the password function was deactivated

If the password protection for an authorization level has been deactivated, i.e., no password is assigned, no login for this level is possible. Therefore access to this authorization level is available without login.

If the password for the “Service” or “Admin” authorization has been deleted (chap. 9.2.5.2), a new password can be assigned for the current level and the next lower level(s) without user login.

Example: The password for the “Admin” authorization level was deleted, therefore every user without login has full access to the functions of the “Admin” authorization level. If access to this level shall become password protected again, the user can assign a new password for the “Admin” authorization level with the “Password” function.

Path: **Main menu > User > Password**

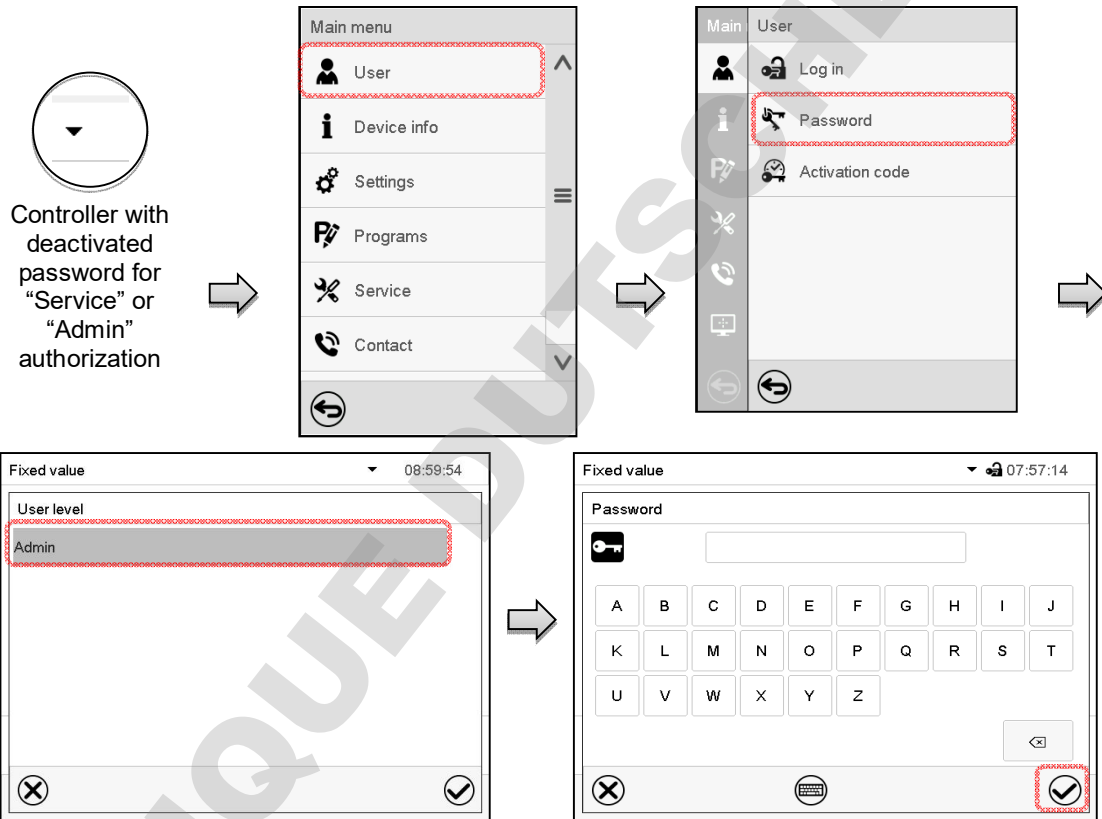

Select the authorization level, for which you want to assign a password.

(Example: “Admin” authorization)

Enter the desired password. If desired, press the **Change keyboard** icon to access other entry windows.

To confirm the entry, press the **Confirm** icon.

Repeat the password entry for confirmation. For each character of the password, the required keyboard appears automatically. Then press the **Confirm** icon.

9.2.6 Activation code

Certain functions of the controller can be unlocked with a previously generated activation code.

The activation code enables access to functions available only in the “Service” authorization level by users without a “Service” authorization. Such functions include e.g., adjustment or extended configurations.

The activation code is available in authorization levels.

Path: **Main menu > User > Activation code**

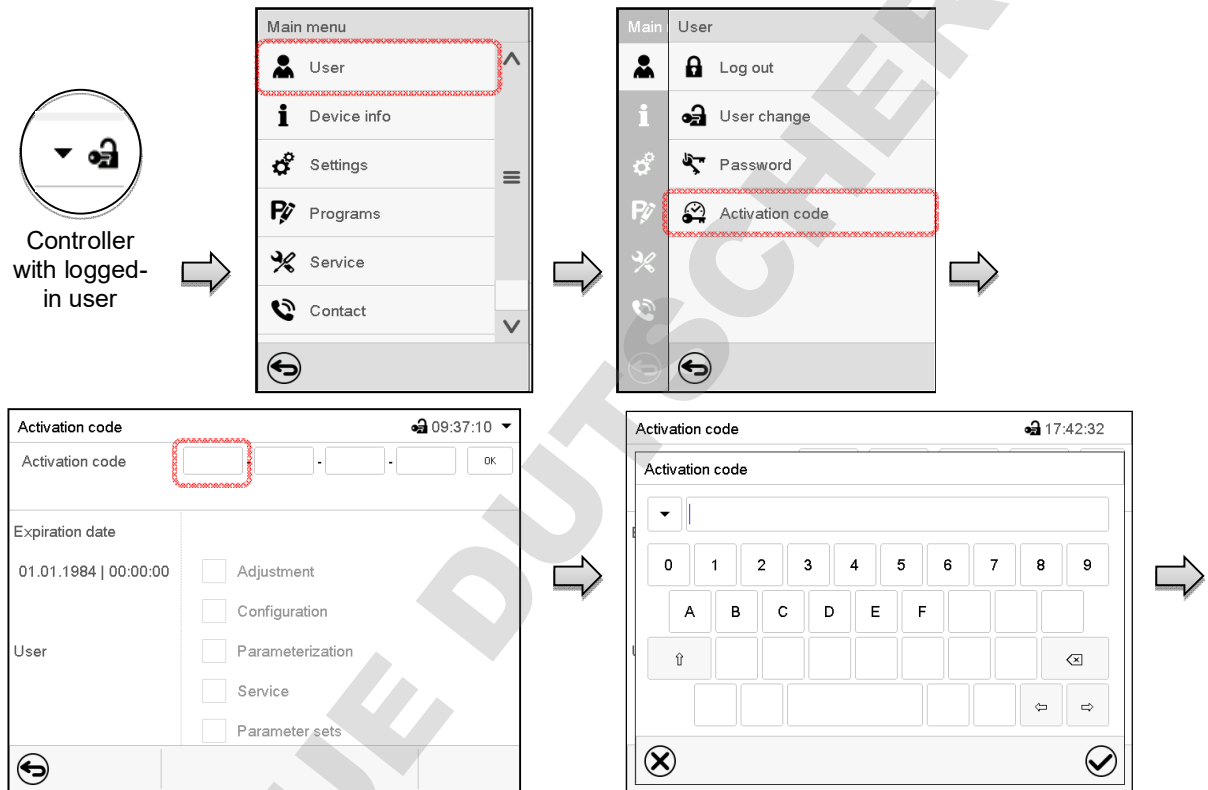

Activation code menu.

Select the first of the four entry fields.

Activation code entry window.

Enter the first four characters of the activation code and press the **Confirm** icon.

Select the next of the four entry fields and proceed accordingly until the entire code has been entered.

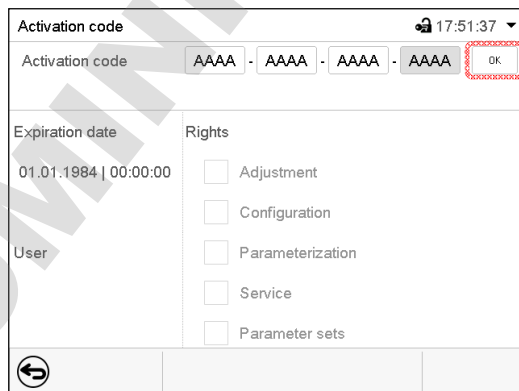

“Activation code” menu with entered code (sample view). Press **OK** to take over the entry

The available functions are indicated by marked checkboxes.

Example: Extended configurations available.

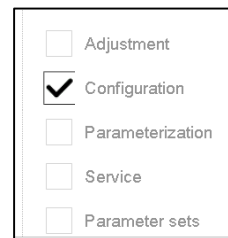

Under “Expiration date” the date of expiry of the code is displayed.

10. General controller settings and information

10.1 RD4 controller

The general settings can be accessed in the “**Settings**” submenu, which is available for users with “Service” or “Admin” authorization level. It serves to enter date and time, select the language for the controller menus and the desired temperature unit and to configure the controller’s communication functions.

The display of some network settings is available for all users in the “**Chamber info**” menu.

10.1.1 Selecting the controller’s menu language

The RD4 controller communicates by a menu guide using real words in German, English, French, Spanish, and Italian languages.

Required access level: “Admin”. Following start-up of the chamber (chap. 6.3.1), it is “User”.

Path: **Normal display**     **Settings**  **Chamber**    **Language***

* Following start-up of the chamber: **Sprache / Language / Langue / Idioma / Lingua**, depending on the language selected before turning off the chamber

Press the **OK button** to enable the setting.

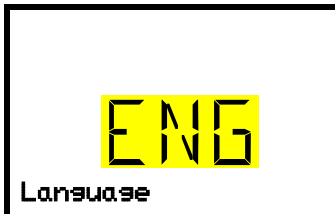

Setting the menu language (example: English).

The current setting flashes. Use the **arrow buttons** to select the desired language.

Confirm the entry with the **OK button**.

With the **arrow-down button (twice)** you can now change to the temperature unit setting.

With the **Back button** you can go back to the “**Chamber**” submenu and, repeatedly pressing it, to **Normal display**.

10.1.2 Selecting the temperature unit

Required access level: “Admin”. Following start-up of the chamber (chap. 6.3.1), it is “User”.

Path: **Normal display**     **Settings**  **Chamber**      **Temperature unit**

Press the **OK button** to enable the setting.

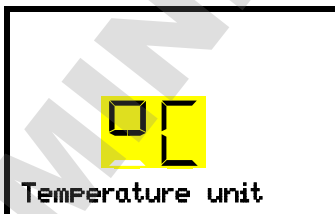

Setting the temperature unit

The current setting flashes. Use the **arrow buttons** to select between °C (degrees Celsius) and °F (degrees Fahrenheit).

Confirm the entry with the **OK button**.

You can change the temperature unit between °C and °F.

If the unit is changed, all values are converted accordingly

	C = degree Celsius	0 °C = 31°F	Conversion: [value in °F] = [value in °C] * 1,8 + 32
	F = degree Fahrenheit	100 °C = 212°F	

With the **Back button** you can go back to the “**Chamber**” submenu and, repeatedly pressing it, to **Normal display**.

10.1.3 Setting the current date

Required access level: “Admin”. Following start-up of the chamber (chap. 6.3.1), it is “User”.

Path: **Normal display** ▾ ▾ ▾ ▾ **Settings** **Chamber** **Date**

Press the **OK button** to enable the setting.

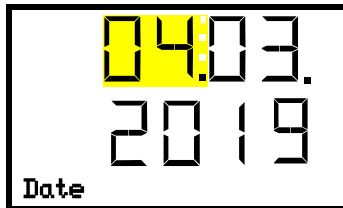

Setting the date: day
The current setting flashes. Enter the current day with the **arrow buttons**.
Confirm the entry with the **OK button**.

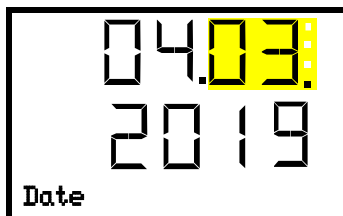

Setting the date: month
The current setting flashes. Enter the current month with the **arrow buttons**.
Confirm the entry with the **OK button**.



Setting the date: year
The left two digits are flashing. Enter the first two digits of the current year with the **arrow buttons**.
Confirm the entry with the **OK button**.

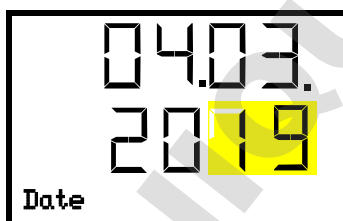

Setting the date: year
The right two digits are flashing. Enter the last two digits of the current year with the **arrow buttons**.
Confirm the entry with the **OK button**.

With the **arrow-down button** you can now change to setting the current time.

With the **Back button** you can go back to the “**Chamber**” submenu and, repeatedly pressing it, to **Normal display**.

10.1.4 Setting the current time

Required access level: "Admin". Following start-up of the chamber (chap. 6.3.1), it is "User".

Path: **Normal display** ▾ ▾ ▾ ▾ **Settings** **Chamber** ▾ **Time**

Press the **OK button** to enable the setting.

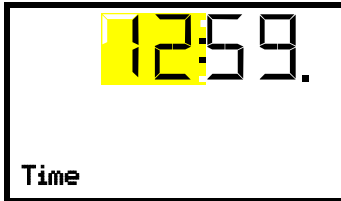

Setting the time: hours
The current setting flashes. Enter the current hour with the **arrow buttons**.
Confirm the entry with the **OK button**.

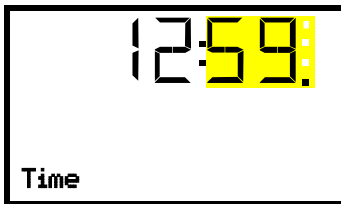

Setting the time: minutes
The current setting flashes. Enter the current minutes with the **arrow buttons**.
Confirm the entry with the **OK button**.

With the **Back button** you can go back to the "**Chamber**" submenu and, repeatedly pressing it, to **Normal display**.

10.1.5 Function "Language selection at restart"

If the function "Language selection at restart" is activated, menu language, date, time, and temperature unit are checked with every startup of the chamber. At this occasion it is also possible to modify them with "User" access level.

Required access level: "Admin".

Path: **Normal display** ▾ ▾ ▾ ▾ **Settings** **Chamber** ▾ ▾ ▾ **Language selection at restart**

Press the **OK button** to enable the setting.



Function "Language selection at restart"
The current setting flashes. Use the **arrow buttons** to select between ON and OFF.
Confirm the setting with the **OK button**.

With the **arrow-down button** you can now change to the next parameter (chamber address).

With the **Back button** you can go back to the "**Chamber**" submenu and, repeatedly pressing it, to **Normal display**.

10.1.6 Setting the chamber address

This setting is required for the communication with the BINDER APT-COM™ 4 Multi Management Software. The chamber address settings in the chamber controller and in the software must be identical.

Required access level: "Admin".

Path: **Normal display** [v] [v] [v] [v] **Settings** [OK] **Chamber** [OK] [v] [v] [v] [v] **Chamber address**

Press the **OK button** to enable the setting.



Setting the chamber address
The current setting flashes. Enter the desired address with the **arrow buttons**. Setting range: 1 up to 254
Confirm the entry with the **OK button**.

With the **arrow-down button** you can now change to the next parameter (display brightness).

With the **Back button** you can go back to the "Chamber" submenu and, repeatedly pressing it, to **Normal display**.

10.1.7 Display brightness

Required access level: "Admin".

Required access level: "Admin".

Path: **Normal display** [v] [v] [v] [v] **Settings** [OK] **Chamber** [OK] [v] [v] [v] [v] **Brightness**

Press the **OK button** to enable the setting.



Setting the display brightness
The current setting flashes. Enter the desired value with the **arrow buttons**. Setting range: 10% up to 100%
Confirm the entry with the **OK button**.

With the **arrow-down button** you can now change to the next parameter (audible alarm, chap. 13.4.1).

With the **Back button** you can go back to the "Chamber" submenu and, repeatedly pressing it, to **Normal display**.

10.1.8 Display of the inner chamber temperature and the heating temperature

Path: **Normal display** [⏏] keep pressed down for 5 seconds.

The current inner chamber temperature (upper value) and the temperature measured directly on the heating element (lower value) are displayed.

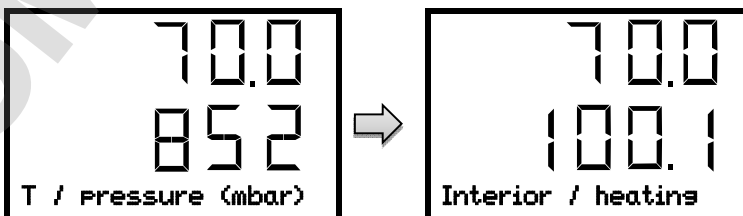

Press down the **Back button** again for 5 seconds to terminate the indication.

10.2 MB2 controller

Most of the general settings can be accessed in the “Settings” submenu, which is available for users with “Service” or “Admin” authorization level. It serves to enter date and time, select the language for the controller menus and the desired temperature unit and to configure the controller’s communication functions.

10.2.1 Selecting the controller’s menu language

The MB2 program controller communicates by a menu guide using real words in German, English, French, Spanish, and Italian.

Path: **Main menu > Settings > Chamber**

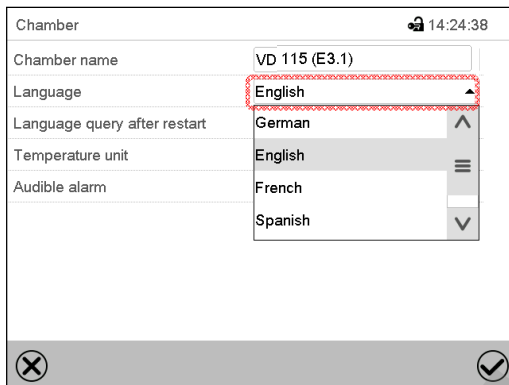

The screenshot shows the 'Chamber' submenu with the following settings:

Chamber name	VD 115 (E3.1)
Language	English
Language query after restart	German
Temperature unit	English
Audible alarm	French
	Spanish

The 'Language' dropdown menu is open, showing 'English' selected. A red dashed box highlights the 'Language' field and the open dropdown menu.

“Chamber” submenu.
Select the desired language.

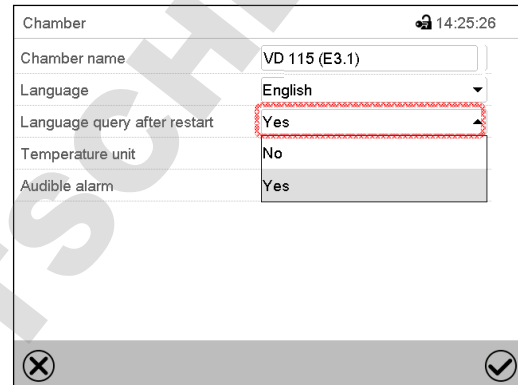

The screenshot shows the 'Chamber' submenu with the following settings:

Chamber name	VD 115 (E3.1)
Language	English
Language query after restart	Yes
Temperature unit	No
Audible alarm	Yes

The 'Language query after restart' dropdown menu is open, showing 'Yes' selected. A red dashed box highlights the 'Language query after restart' field and the open dropdown menu.

“Chamber” submenu.
Select if there shall be a language query after restarting the chamber and press the **Confirm** icon.

Return to Normal display with the **Back** icon to take over the entries.

10.2.2 Setting date and time

Following start-up of the chamber after language selection:

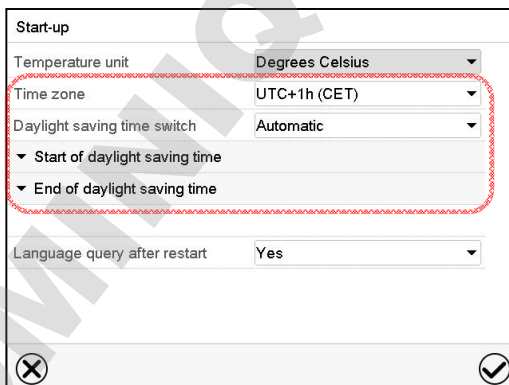

The screenshot shows the 'Start-up' submenu with the following settings:

Temperature unit	Degrees Celsius
Time zone	UTC+1h (CET)
Daylight saving time switch	Automatic
Start of daylight saving time	
End of daylight saving time	
Language query after restart	Yes

The 'Time zone' dropdown menu is open, showing 'UTC+1h (CET)' selected. A red dashed box highlights the 'Time zone' field and the open dropdown menu.

Select the time zone and configure the daylight saving time switch.

Or later:

Path: **Main menu > Settings > Date and time**

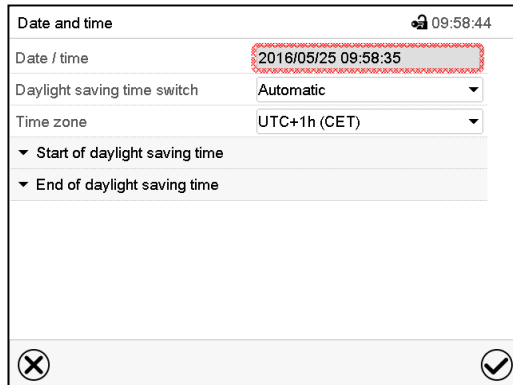

“Date and time” submenu.
Select the field “Date / time”.

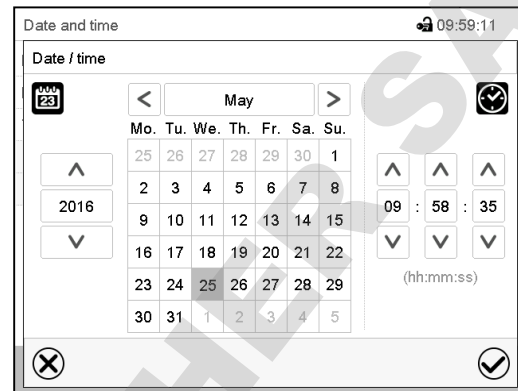

“Date / time” entry menu.
Enter date and time and press the **Confirm** icon.

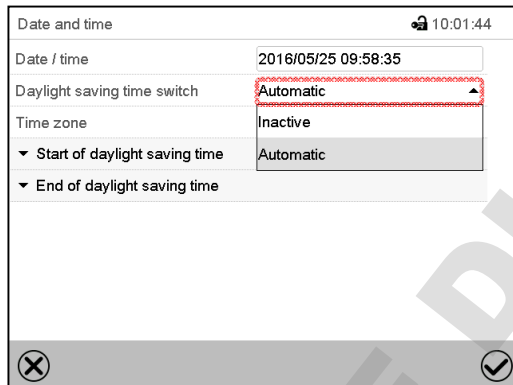

“Date and time” submenu.
In the field “Daylight saving time switch” select the desired setting “Automatic” or “Inactive”.

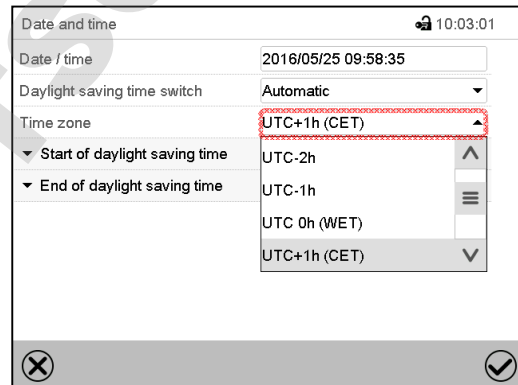

“Date and time” submenu.
Select the desired time zone and press the **Confirm** icon.

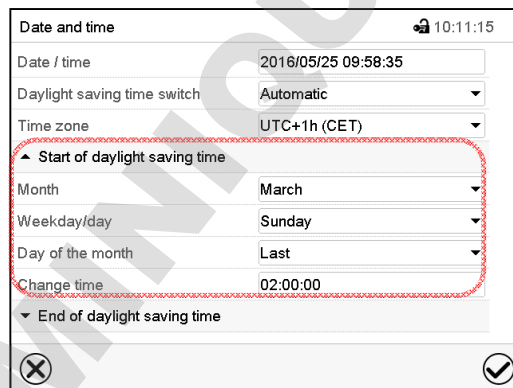

“Date and time” submenu.
Select the desired start of the daylight saving time.

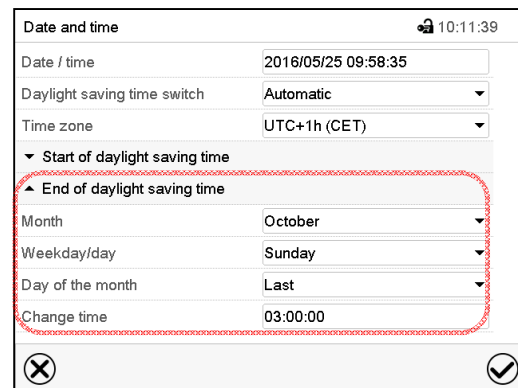

“Date and time” submenu.
Select the desired end of the daylight saving time and press the **Confirm** icon.

After completing the settings, press the **Confirm** icon to take over the entries and exit the menu, or press the **Close** icon to exit the menu without taking over the entries.

10.2.3 Selecting the temperature unit

Following start-up of the chamber:

Or later:

Path: [Main menu](#) > [Settings](#) > [Chamber](#)

Select the desired temperature unit and press the **Confirm** icon.

Change of the temperature unit between °C and °F.

If the unit is changed, all values are converted accordingly

	C = degree Celsius	0 °C = 31°F	Conversion: [value in °F] = [value in °C] * 1,8 + 32
	F = degree Fahrenheit	100 °C = 212°F	

10.2.4 Display configuration

10.2.4.1 Adapting the display parameters

This function serves to configure parameters like display brightness and operating times.

Path: [Main menu](#) > [Settings](#) > [Display](#) > [Display](#)

“Display” submenu.

- Select the field “Brightness”.
- Move the grey slide to the left or right to define the brightness of the display
- left = darker (minimum value: 0)
 - right = brighter (maximum value: 100)
- Press the **Confirm** icon.



- Select the field “Wait time for screen saver” and enter the desired waiting time for the screen saver in seconds. Setting range: 10 sec up to 32767 sec. During the waiting time the display is off. Confirm entry with **Confirm** icon.

- In the field “Activate continuous operation” select the desired setting “Yes” or “No”.

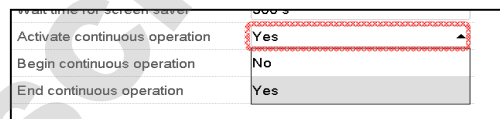

- Select the field “Begin continuous operation” (possible only if continuous operation is activated) and enter the time with the arrow keys. Confirm entry with **Confirm** icon.
- Select the field “End continuous operation. (only possible if continuous operation is activated) and enter the time with the arrow keys. Confirm entry with **Confirm** icon.

After completing the settings, press the **Confirm** icon to take over the entries and exit the menu, or press the **Close** icon to exit the menu without taking over the entries.

10.2.4.2 Touchscreen calibration

This function serves to optimize the display for the user’s individual angular perspective.

Path: **Main menu > Calibrate touchscreen**

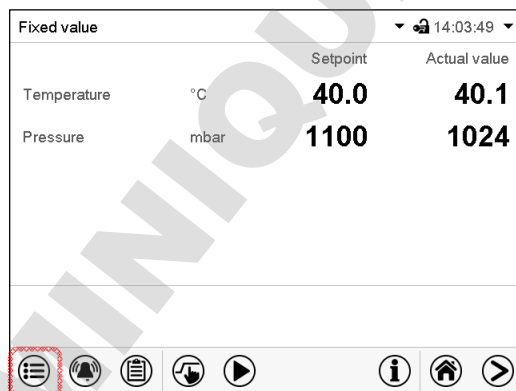

Normal display.

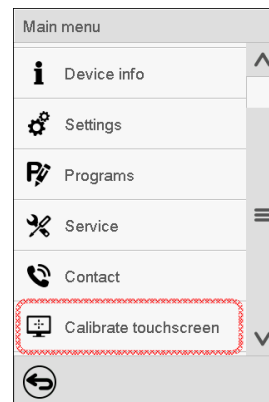

Select “Calibrate touchscreen” and follow the instructions on the display.

You need to touch all four corners of the touchscreen to calibrate it. Appropriate boxes appear successively in each corner.

	<p>The waiting icon shows how much time there is left to touch the currently activated box. If the box is not touched within this period, calibration is aborted and the display changes to Normal display.</p>
---	---

After completing the calibration, i.e., touching all four boxes, the display changes to Normal display.

10.2.5 Event list

The "Event list" displays status information and errors of the current day. It enables to view the last 100 events or defective conditions of the chamber.

	<p>Press the Event list icon to access the event list from Normal display.</p>
---	---

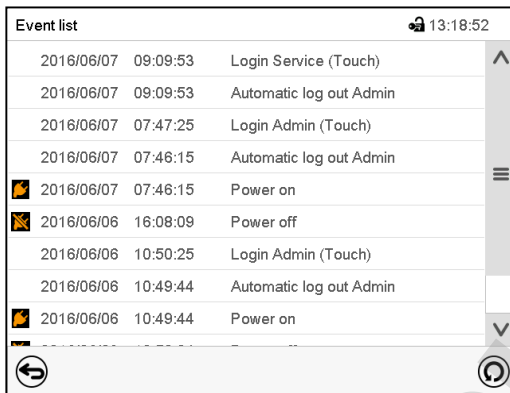

Event list

	<p>Press the Update icon to update the event list.</p>
---	---

	<p>Attention: Following a modification of the language setting (chap. 10.1.1) or the storage interval of the chart recorder (chap. 21.2) the Event list is cleared.</p>
---	--

10.2.6 Service contact page

Path: [Main menu](#) > [Contact](#)

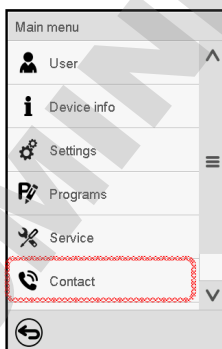

10.2.7 Current operating parameters

 Press the **Information** icon to access the “Info” menu from Normal display.

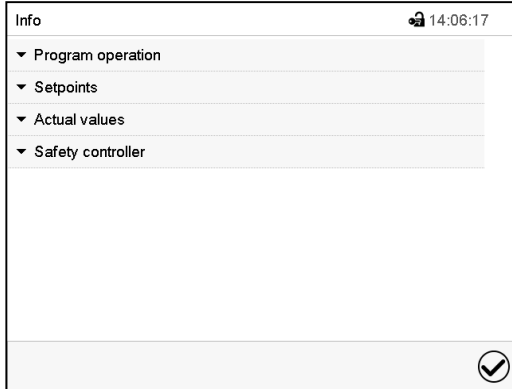

“Info” menu.
Select the desired information.

- Select “Program operation” to see information on a currently running program.
- Select “Setpoints” to see information on the entered setpoints and operation lines.
- Select “Actual values” to see information on the current actual values.
- Select “Safety controller” to see information on the safety controller status.

10.2.8 Technical chamber information

Path: [Main menu > Device info](#)

	Chamber name and setup	
	Versions of CPU, I/O module and safety controller	for BINDER Service
	Information on digital and analog inputs and outputs and phase angle outputs	for BINDER Service
	Information on modbus analog and digital inputs	for BINDER Service
	Information on Ethernet connection, MAC address display	chap. 18.2.1
	Back to main menu	

11. Temperature safety devices

11.1 Over temperature protective device class 2 (thermal switch)

The chamber is equipped with an internal temperature safety device class 2.0 acc. to DIN 12880:2007. It serves to protect the chamber and prevent dangerous conditions caused by major defects of the chamber. It is electrically independent of the controller (bimetallic switch).

When the fixed temperature of **330 °C** is measured at the thermal switch, the overtemperature protective device turns off the heating. This is the equivalent to an inner chamber temperature of 270 °C up to 300 °C.

The alarm message "Overtemperature" is displayed on the controller.

If the overtemperature protective device has turned off the heating, proceed as follows:

- Confirm the alarm message on the controller.
- Disconnect the chamber from the power supply (pull the power plug) and let it cool down
- If appropriate, have an expert examine and rectify the cause of the fault.
- Restart the chamber.

As soon as the inner chamber temperature after restart is below the defined cut-off temperature of the overtemperature protective device of 230 °C, the heating is released again.

11.2 Overtemperature safety controller class 2

The chambers are regularly equipped with an electronic overtemperature safety controller (temperature safety device class 2 – temperature limiter) acc. to DIN 12880:2007). The safety controller protects the chamber, its environment and the charging material against exceeding the maximum permissible temperature. The safety device class 2 is electrically independent of the temperature controller and turns off the chamber permanently.

In the event of a fault in the temperature controller, the safety controller turns off the vacuum drying oven permanently, i.e. until manual alarm reset. This condition (state of alarm) is indicated visually and additionally with an audible alert if the buzzer is enabled (chap. 13.4.1). You can turn off the buzzer with the **OK button / Confirm** icon. The alarm persists until the chamber cools down below the configured safety controller value.

Please observe the DGUV guidelines 213-850 on safe working in laboratories, issued by the employers' liability insurance association (for Germany).

	Check the setting regularly and adjust it following changes of the set-point or charge.
---	---

	The temperature safety device only activates after the set-point has been reached once.
---	---

11.2.1 Safety controller mode

You can set the **safety controller mode** to "Limit" or "Offset".

- **Limit:** Limit value, absolute maximum permitted temperature value

This setting offers high safety as a defined temperature limit will not be exceeded. It is important to adapt the safety controller value after each modification of the temperature set-point. Otherwise, the limit could be too high to ensure efficient protection, or, in the opposite case, it could prevent the controller from reaching an entered set-point outside the limit range.

- **Offset:** Offset value, maximum overtemperature above any active temperature set point. The resulting maximum temperature changes internally and automatically with every temperature set-point change.

MB2 controller: This setting is recommended for program operation. It is important to check the safety controller set-point and safety controller mode occasionally, as it does not offer a fix, independent limit temperature value, which would never be exceeded.

Example:

Desired temperature value: 40 °C, desired safety controller value: 45 °C.

Possible settings for this example:

Temperature set point	Safety controller mode	Safety controller value
40 °C	Limit	Limit value 45 °C
	Offset	Offset value 5 °C

11.2.2 Setting the safety controller

11.2.2.1 RD4 controller: Setting the safety controller mode

Required access level: "User".

Path: **Normal display** **Setpoints** **Safety controller** **Mode**

Press the **OK button** to enable the setting.

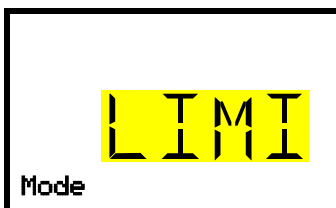

Setting the safety controller mode
The current setting flashes. Use the **arrow buttons** to select between LIMI (Limit) and OFFS (Offset).
Confirm the setting with the **OK button**.

With the **arrow-down button** you proceed to setting the safety controller value (chap. 11.2.2.2))

With the **Back button** you can go back to the "**Safety controller**" submenu and, repeatedly pressing it, to **Normal display**.

11.2.2.2 RD4 controller: Setting the safety controller value

Required access level: "User".

The desired safety controller mode must be selected first (chap. 11.2.2.1). Depending on the mode setting, one of the following setting menus will appear.

Path: **Normal display** **Setpoints** **Safety controller** **Limit** or **Offset**

Press the **OK button** to enable the setting.

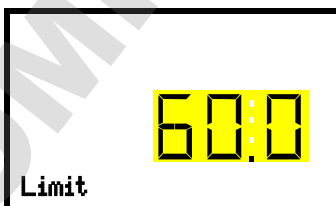

Setting the safety controller value with "Limit" safety controller mode.
The current value flashes. Enter the desired limit value with the **arrow buttons**.
Confirm the entry with the **OK button**.

or



Setting the safety controller value with “Offset” safety controller mode
The current value flashes. Enter the desired offset value with the **arrow buttons**.
Confirm the entry with the **OK button**.

With the **Back button** you can go back to the “**Safety controller**” submenu and, repeatedly pressing it, to **Normal display**.



Regularly check the settings of the safety controller mode and value.
Set the safety controller value by approx. 5 °C above the desired temperature set-point.

11.2.2.3 MB2 controller



Press the **Setpoint setting** icon to access the “Setpoint” setting menu from Normal display.

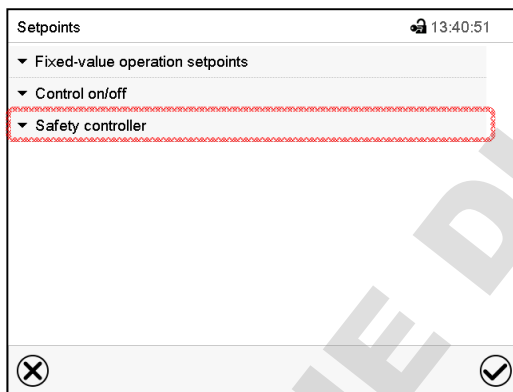

“Setpoints” menu.
Select the field “Safety controller” to access the settings.

- In the field “Mode” select the desired setting “Limit” or “Offset”.

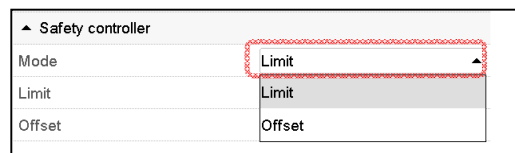

- Select the corresponding field “Limit” **or** “Offset” according to the selected mode and enter the desired safety controller setpoint. Confirm entry with **Confirm** icon.



Regularly check the safety controller setting for set-point type “Limit” or “Offset”

- in Fixed value operating mode according to the entered set-point temperature value
- in program mode according to the highest temperature value of the selected temperature program

Set the safety controller set-point by approx. 5 °C above the desired temperature set-point.

After completing the settings, press the **Confirm** icon to take over the entries and exit the menu, **or** press the **Close** icon to exit the menu without taking over the entries.

11.2.3 Message and measures in the state of alarm

11.2.3.1 RD4 controller

The state of alarm is indicated visually in Normal display. If the buzzer is enabled (chap. 13.4.1) there is an additional audible alert. The heating turns off. As soon as the inner chamber temperature has cooled down below the safety controller value, the heating can be released. Only then the temperature control continues.

In Normal display a text message indicates the alarm cause. The “collective alarm” icon flashes. If the audible arm is activated, the buzzer sounds. Press the **OK button** to mute the buzzer.

The alarm message “Safety controller” and the “Collective alarm” icon are displayed on the controller until you press the **OK button** on the controller **and** the inner chamber temperature has cooled down below the safety controller value.

- If the inner chamber temperature has already cooled down below the safety controller value when pressing the **OK button**, the alarm message “Safety controller” and the “Collective alarm” icon are reset together with the buzzer.
- If the state of alarm is still active when pressing the **OK button**, i.e. the inner chamber temperature is still above the safety controller value, first only the buzzer is reset. The alarm message “Safety controller” and the “Collective alarm” icon will disappear as soon as the inner chamber temperature falls below the safety controller value.
- The alarm remains active until it is acknowledged on the controller and the inner temperature falls below the entered safety controller setpoint. Then the heating is released again.



Normal display showing safety controller alarm (sample values)

Note: When the safety controller class 2 had been activated you should disconnect the chamber from the power supply and have an expert examine and rectify the cause of the fault.

11.2.3.2 MB2 controller

The state of alarm is indicated visually and additionally with an audible alert if the buzzer is enabled (chap. 13.4).

The alarm remains active until it is acknowledged on the controller and the inner temperature falls below the set safety controller setpoint. Then the heating is released again.

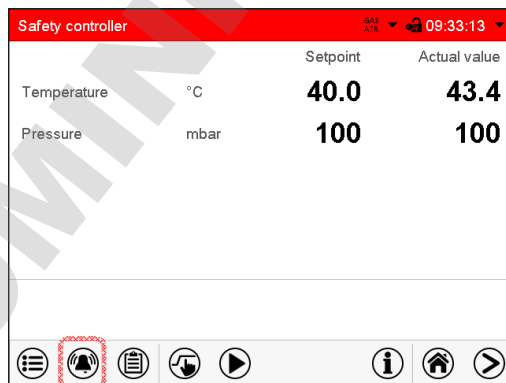

Normal display with safety controller alarm.
Press the **Alarm** icon

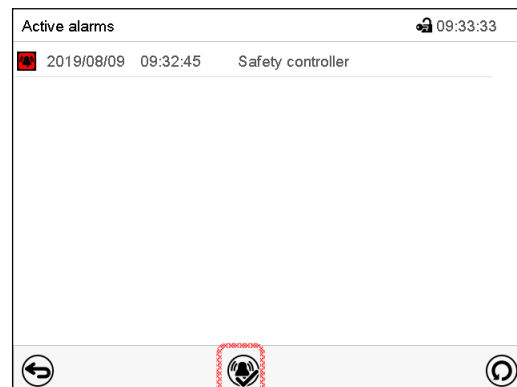

List of active alarms.
Press the **Reset alarm** icon.

11.2.4 Function check

Check the safety controller at appropriate intervals for its functionality. It is recommended that the authorized operating personnel should perform such a check, e.g., before starting a longer work procedure.

12. Tolerance range settings

In this menu you can define for temperature and pressure the deviation between the actual value and setpoint, which that shall cause a tolerance range alarm. The entered value defines the limit of permitted deviations from the set-point (exceeding and falling below). Reaching this limit triggers tolerance alarm.

In addition you can specify delay times for these alarms.

This function only activates after the set-point has been reached once.

12.1 RD4 controller

Required access level: "Admin".

12.1.1 Setting the delay time for temperature tolerance range alarm

Path: **Normal display**     **Settings**     **Various**  **Temp. alarm delay(min)**

Press the **OK button** to enable the setting.

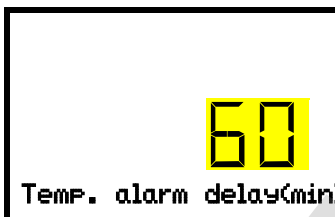

Setting the delay for temperature tolerance range alarm.

The current setting flashes. Use the **arrow buttons** to enter the desired time after which the range alarm shall be triggered. Entry range: 1 up to 120 minutes.

Confirm the entry with the **OK button**.

With the **arrow-down button** you can now change to the temperature tolerance range setting.

With the **Back button** you can go back to the "Various" submenu and, repeatedly pressing it, to **Normal display**.

12.1.2 Setting the temperature tolerance range

Path: **Normal display**     **Settings**     **Various**   **Temperature range(°C)**

Press the **OK button** to enable the setting.

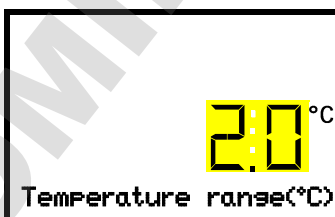

Setting the temperature tolerance range

The current setting flashes. Enter the desired temperature range with the **arrow buttons**. Entry range: 1.0 °C up to 10.0 °C

Confirm the entry with the **OK button**.

With the **arrow-up button** you can go back to setting the delay for temperature tolerance range alarm.

With the **arrow-down button** you can now change to setting the delay for pressure tolerance range alarm.

With the **Back button** you can go back to the “**Various**” submenu and, repeatedly pressing it, to **Normal display**.

12.1.3 Setting the delay time for pressure tolerance range alarm

Path: **Normal display** ▾ ▾ ▾ ▾ **Settings** ▾ ▾ ▾ **Various** ▾ ▾ **Press. alarm delay(min)**

Press the **OK button** to enable the setting.

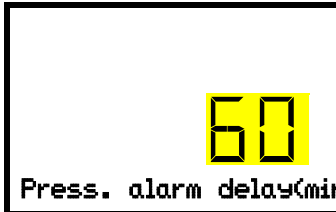

Setting the delay for pressure tolerance range alarm.
The current setting flashes. Use the **arrow buttons** to enter the desired time after which the range alarm shall be triggered. Entry range: 1 up to 120 minutes.
Confirm the entry with the **OK button**.

With the **arrow-up button** you can go back to the temperature tolerance range setting.

With the **arrow-down button** you can now change to the pressure tolerance range setting.

With the **Back button** you can go back to the “**Various**” submenu and, repeatedly pressing it, to **Normal display**.

12.1.4 Setting the pressure tolerance range

Path: **Normal display** ▾ ▾ ▾ ▾ **Settings** ▾ ▾ ▾ **Various** ▾ ▾ ▾ **Pressure range(mbar)**

Press the **OK button** to enable the setting



Setting the pressure tolerance range
The current setting flashes. Enter the desired pressure range with the **arrow buttons**. Entry range: 10 mbar up to 200 mbar.
Confirm the entry with the **OK button**.

With the **arrow-up button** you can go back to setting the delay for pressure tolerance range alarm.

With the **Back button** you can go back to the “**Various**” submenu and, repeatedly pressing it, to **Normal display**.

12.1.5 State of alarm

If there are any actual values outside the tolerance range, after the configured alarm delay time the alarm message “Temperature range alarm” and / or “Pressure range alarm” is displayed in Normal display (chap. 13.1.1). If the alarm buzzer is activated (chap. 13.4.1) there is an audible alert.

12.2 MB2 controller

12.2.1 Setting the alarm delay times and the tolerance ranges

Path: [Main menu](#) > [Settings](#) > [Various](#)

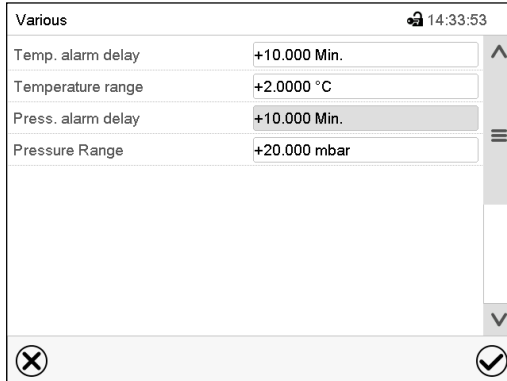

The screenshot shows a 'Various' submenu with the following settings:

Parameter	Value
Temp. alarm delay	+10.000 Min.
Temperature range	+2.0000 °C
Press. alarm delay	+10.000 Min.
Pressure Range	+20.000 mbar

Navigation icons: Close (X), Confirm (checkmark), and a scroll bar on the right.



Submenu "Various".

- Select the field "**Temp. alarm delay**" and enter the time in minutes, after which the temperature range alarm shall be triggered. Setting range: 1 min to 120 min. Confirm entry with **Confirm** icon.
- Select the field "**Temperature range**" and enter the desired value for the temperature range. Setting range: 1,0 °C to 10,0 °C. Confirm entry with **Confirm** icon.
- Select the field "**Press. alarm delay**" and enter the time in minutes, after which the pressure range alarm shall be triggered. Setting range: 1 min to 120 min. Confirm entry with **Confirm** icon.
- Select the field "**Pressure range**" and enter the desired value for the pressure range. Setting range: 10 mbar to 200 mbar. Confirm entry with **Confirm** icon.

After completing the settings, press the **Confirm** icon to take over the entries and exit the menu, **or** press the **Close** icon to exit the menu without taking over the entries.

12.2.2 Alarm condition

If there are actual values outside the tolerance range the following information icons for the corresponding parameter are displayed:

Icon	Signification	Information
	"Temperature range"	The current actual temperature value is outside the tolerance range
	"Pressure range"	The current actual pressure value is outside the tolerance range

If the condition persists, an alarm is triggered after the configured interval ("range alarm delay"). It is visually indicated in Normal display. If the alarm buzzer is activated (chap. 13.4) there is an audible alert. The alarm is shown in the list of active alarms (chap. 13.3).

13. Notification and alarm functions

13.1 Information messages

13.1.1 RD4 controller

Information messages provide information about the settings made or the current controller condition.

 In Normal display a text message indicates the condition. The “Information” icon is flashing slowly.

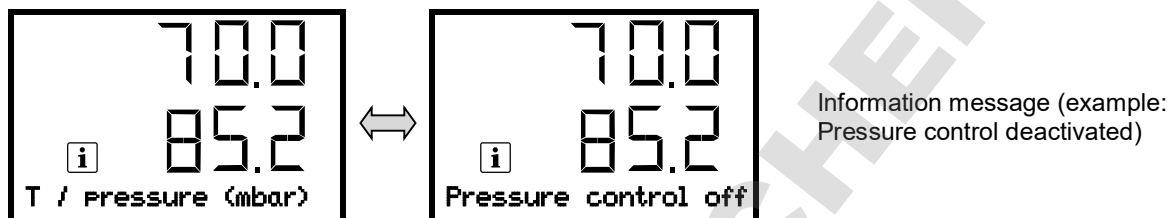

If there are several information messages, they are displayed one after the other.





Information messages overview:

Condition	Information message	Moment of information message
Standby mode activated	“Standby”	During Standby mode
Temperature control deactivated	“Temperature control off”	Following deactivation of temperature control
Pressure control deactivated	“Pressure control off”	Following deactivation of pressure control
Recommended maintenance interval (one year of operation) is over.	“Service due!”	“Service due!”
With activated drying monitoring: Drying finished	“Drying finished”	After the solvent has evaporated

Press the **OK button** to confirm the information message.

Additionally the activated functions are indicated by an icon in Normal display showing the number of the respective function.

Overview of the information icons of the activated controller functions:

Condition	Information icon in Normal display
Standby mode	
Ventilation via optional connection “GAS/AIR 2” (5). Regular connection “GAS/AIR” (4) deactivated.	
All valves closed	
Socket of vacuum module turned off	

If several functions are simultaneously active, the icon displays a combination of the corresponding numbers, e.g. .

13.1.2 MB2 controller

Information messages are indicated by **information icons** displayed in the screen header in Normal display

An information icon serves as an indication of a certain condition.

If this condition persists, in some cases an alarm will be triggered after a fix or configurable interval. As long as the condition persists, the information icon therefore continues to be displayed also in state of alarm. If during alarm the conditions ends, e.g., if during a tolerance range alarm the actual value returns to within the tolerance range, the information icon disappears, whereas the alarm will continue until manual acknowledgement.



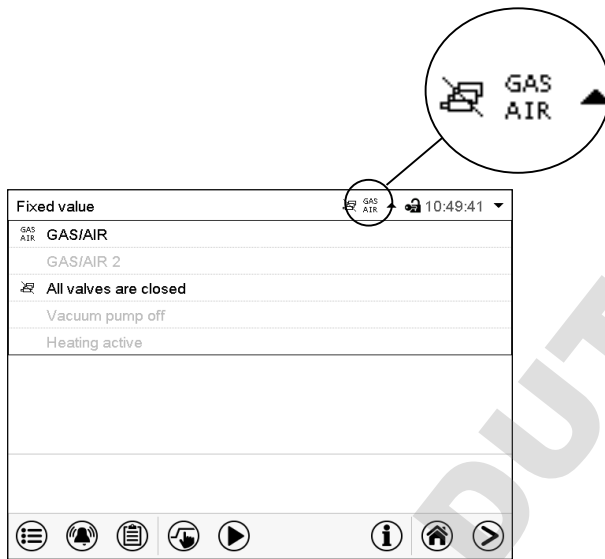



Press the flash icon next to the information icon to access the corresponding text information.



Normal display showing the text information.

The currently valid information texts are highlighted in black (example: "All valves are closed" and "GAS/AIR")

Information messages overview:

Condition	Information icon	Text information	Start after condition occurred
Deactivated temperature control		Temperature setpoint value display shows " _ _ _ _ "	immediately
Deactivated pressure control		Pressure setpoint value display shows " _ _ _ _ "	immediately
Chamber is heating up		"Heating active"	immediately
All valves are closed		"All valves are closed"	immediately
Ventilation via regular connection "GAS/AIR" (4)		"GAS/AIR"	immediately
Ventilation via optional connection "GAS/AIR 2" (5). Regular connection "GAS/AIR" (4) deactivated.		"GAS/AIR 2"	immediately
Standby mode activated		"Standby"	immediately
Vacuum pump turned off		"Pump off"	immediately

Information messages are not shown in the event list.

13.2 Alarm messages

13.2.1 RD4 controller

In the event of equipment failures, when the temperature and / or pressure deviate from the set tolerance range limits, optical and possibly acoustic alarm messages are given out via the controller.

The alarm messages on leaving the tolerance range are emitted after a configurable delay (chap. 12.1.1, 12.1.2), the others immediately when the fault occurs. The tolerance range alarm is suppressed after turning on the chamber until the setpoint is reached and then for the selected delay time.



In Normal display a text message indicates the alarm cause. The “collective alarm” icon flashes. If the audible arm is activated, the buzzer sounds.

If more than one alarm signal is sent simultaneously, they are displayed in a cycle.

Press the **OK button** to confirm the alarm and mute the buzzer. If the alarm cause is still valid, the “collective alarm” icon is lit.

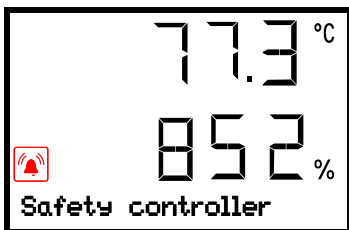

Alarm indication (example: safety controller alarm)
(sample values)

Alarm messages overview:

Condition	Alarm message	Start after condition occurred
Tolerance range alarm: actual temperature value exceeding the tolerance range)	“Temperature range alarm”	after configurable time (chap. 12.1.1) Factory setting: 10 minutes
Tolerance range alarm: actual pressure value exceeding the tolerance range)	“Pressure range alarm”	after configurable time (chap. 12.1.2) Factory setting: 10 minutes
Exceeded setpoint of the safety controller class 2	“Safety controller”	immediately
Overtemperature protective device class 2 (thermal switch) activated	“Overtemperature”	immediately
Temperature sensor defective.	Actual temperature value display shows “ _ _ _ _ ”	immediately
Failure of pressure sensor	Actual pressure value display shows “ _ _ _ _ ”	immediately
Failure of temperature sensor for object temperature (option)	(no value shown)	immediately



When operating the chamber without vacuum connection, turn off pressure control (chap. 8.6) in order to avoid alarms of the pressure system.

13.2.2 MB2 controller

Alarm messages overview:

Condition	Alarm message	Start after condition occurred
The current actual temperature value is outside the tolerance range (chap. 12)	"Temperature range"	after configurable time (chap. 12.2.1) Factory setting: 10 minutes
The current actual pressure value is outside the tolerance range (chap. 12)	"Pressure range"	after configurable time (chap. 12.2.1) Factory setting: 10 minutes
Exceeded setpoint of the safety controller class 2	"Safety controller"	immediately
Overtemperature protective device class 2 (thermal switch) activated	"Overtemperature"	immediately
Temperature sensor defective	Actual temperature value display shows e.g. "----" or "<-<-<" or ">->->"	immediately
Pressure sensor defective	Actual pressure value display shows e.g. "----" or "<-<-<" or ">->->"	immediately
Failure of temperature sensor for object temperature (option)	(no value shown)	immediately

Alarm messages are displayed in the list of active alarms until acknowledging them. They are also shown in the event list.

	When operating the chamber without vacuum connection, turn off pressure control (chap. 8.6) in order to avoid alarms of the pressure system.
--	--

State of alarm

1. Visual indications in Normal display: alarm message, screen header flashing in red color
2. Audible alert, if the buzzer is enabled (chap. 13.4).

(a)

(b)

Normal display in state of alarm (example).

(a) Screen header flashing in red color and showing the alarm message

(b) **Alarm** icon on the bottom of the screen: change to the list of active alarms and alarm acknowledgement

13.3 Resetting an alarm

13.3.1 RD4 controller

Press the **OK button** to confirm the alarm.

- Confirmation while the state of alarm persists: Only the buzzer is muted. The visual alarm message continues to be displayed until the alarm condition is removed. Then it is reset automatically.
- Confirmation after the alarm has ended: The buzzer and the visual alarm message are reset together.

13.3.2 MB2 controller

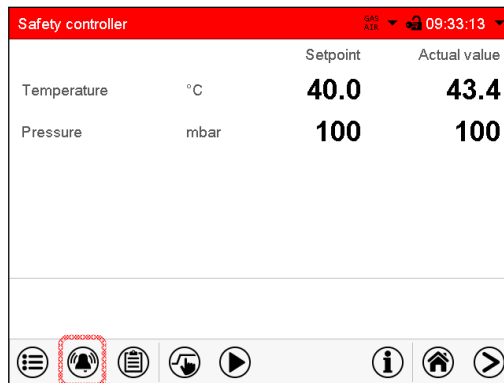

Normal display in state of alarm (example).

Press the **Alarm** icon

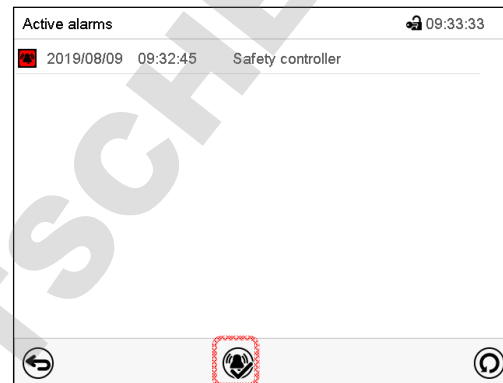

List of active alarms.

Press the **Reset alarm** icon.

Pressing the **Reset alarm** icon mutes the buzzer for all active alarms. The icon then disappears.

- Acknowledging while the alarm condition persists: Only the buzzer turns off. The visual alarm indication remains on the controller display. The alarm remains in the list of active alarms.

When the alarm condition has ended, the visual alarm indication is automatically cleared. The alarm is then no longer in the list of active alarms.

- Acknowledging after the alarm condition has ended: The buzzer and the visual alarm indication are reset together. The alarm is then no longer in the list of active alarms.

13.4 Activating / deactivating the audible alarm (buzzer)

13.4.1 RD4 controller

Path: **Normal display** ▾ ▾ ▾ ▾ **Settings** **Chamber** ▾ ▾ ▾ ▾ ▾ **Audible alarm**

Press the **OK button** to enable the setting.

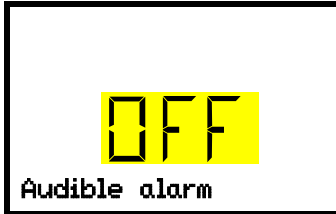

Setting the audible alarm.

The current setting flashes. Use the **arrow buttons** to select between ON and OFF.

Confirm the setting with the **OK button**.

With the **Back button** you can go back to the “**Chamber**” submenu and, repeatedly pressing it, to **Normal display**.

13.4.2 MB2 controller

Path: **Main menu > Settings > Chamber**

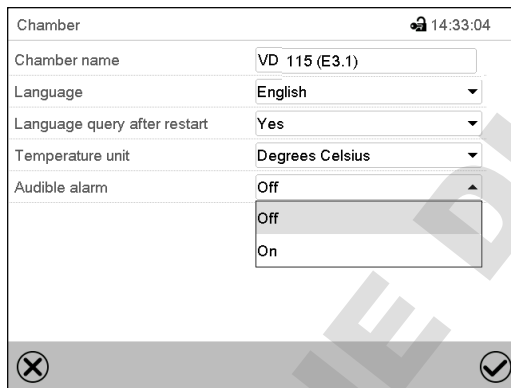

“Chamber” submenu (example).

In the field “Audible alarm” select the desired setting “off” or “on” and press the **Confirm** icon.

14. RD4 controller: Program start / stop function

You can start and stop time or week programs at the RD4 controller. The programming itself has to be done using the APT-COM™ 4 Multi Management Software from BINDER (chap. 23.1). There you can create the programs and transfer them to the chamber controller.

Required access level: "User".

14.1 Start time program

Path: **Normal display**   **Programs**  **Time program**

Press the **OK button** to enter the program start submenu.

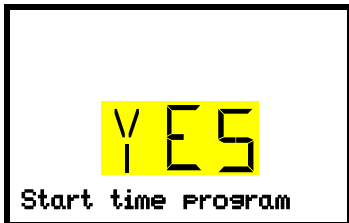

"Start time program" submenu

The current setting flashes. Select with the **arrow buttons** between YES (start time program) and NO (do not start time program).

To start the time program select "YES" and press the **OK button** to confirm.

With the **Back button** you can go back to the "**Programs**" submenu and, repeatedly pressing it, to **Normal display**.

After selecting "NO": The controller changes back to Normal display.

After selecting "YES": The time program starts, the controller displays the information "Program started". Press the **OK button**. The controller changes to Normal display. The information "Time program active" is displayed alternately with "T / pressure (mbar)".

14.2 Start week program

Path: **Normal display**   **Programs**   **Week program**

Press the **OK button** to enter the program start submenu.



"Start week program" submenu

The current setting flashes. Select with the **arrow buttons** between YES (start week program) and NO (do not start week program).

To start the week program select "YES" and press the **OK button** to confirm.

With the **Back button** you can go back to the "**Programs**" submenu and, repeatedly pressing it, to **Normal display**.

After selecting "NO": The controller changes back to Normal display.

After selecting "YES": The week program starts, the controller displays the information "Program started". Press the **OK button**. The controller changes to Normal display. The information "Weeek program active" is displayed alternately with "T / pressure (mbar)".

14.3 Stop program

Path: **Normal display**   **Programs**   **Stop program**

Press the **OK button** to activate the settings.

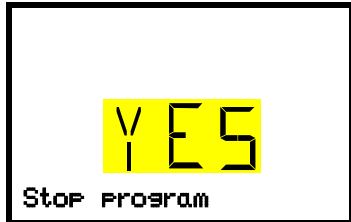

"Stop program" submenu

The current setting flashes. Select with the **arrow buttons** between YES (stop program) and NO (do not stop program).

To start the week program select "YES" and press the **OK button** to confirm.

With the **Back button** you can go back to the "**Programs**" submenu and, repeatedly pressing it, to **Normal display**.

After selecting "NO": The controller changes back to Normal display. The program continues.

After selecting "YES": The program stops. Press the **OK button**. The controller changes to Normal display.

15. MB2 controller: Timer program (stopwatch function)

During an entered duration the controller constantly equilibrates to the setpoints entered in Fixed value operation mode (temperature, pressure, configuration of the special controller functions). This duration can be entered as a "Timer program". During the program runtime, any setpoint changes do not become effective; the controller equilibrates to the values which were active during program start.



15.1 Starting a timer program

 In Normal display press the **Program start** icon to access the "Program start" menu.

Program start		07:37:40
Program type	Timer program	
Program	Time program	
Start section	Week program	
Program duration	Timer program	
Program start	2016/06/03 07:34:10	
Program end	2016/06/03 07:34:10	
Program info	Programhinweis	

"Program start" menu

- In the field "Program type" select "Timer program".
- Select the field "Program duration" and enter the desired program duration. Press the **Confirm** icon.
- Select the field "Program start" and enter the desired start time of the program in the "Program start" entry menu. Press the **Confirm** icon. The program delay time until program start begins.

Program	Timerprogramm	Program runtime
		00:00:40
		

Normal display.

Information on the bottom of the screen indicates the currently running program and the time already passed. The grey bar shows how much time of the whole time is elapsed.

15.1.1 Performance during program delay time

During the configured program delay time until program start, the controller equilibrates to the current setpoints of Fixed value operation mode. Modifications of these setpoints are possible but become effective only after the timer program is finished. When the configured moment for program start is reached, the program delay time ends and the program starts running. The controller equilibrates to the values which had been active during program start.

15.2 Stopping a running timer program

15.2.1 Pausing a running timer program

	Press the Program pause icon to interrupt the program.
---	---

The program is paused. The program runtime stops running down, the time display flashes.

There are the following options:

	Press the Program start icon to continue the program
---	---

	Press the Cancelling icon to cancel the program
---	--

15.2.2 Cancelling a running timer program

	Press the Program cancelling icon to cancel the program.
---	---

A confirmation prompt is displayed. Press the **Confirm** icon to confirm that the program shall really be cancelled.

After confirming the message the controller changes to Fixed value operation mode. Temperature and humidity will then equilibrate to the setpoints of Fixed value operation mode.

15.3 Performance after the end of the program

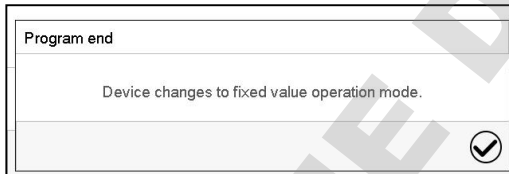

After the end of the program the message “Device changes to fixed value operation mode” appears on the screen.

Press the **Confirm** icon.

After confirming the message the controller changes to Fixed value operation mode. Temperature and humidity will then equilibrate to the setpoints of Fixed value operation mode.

16. MB2 controller: Time programs

The MB2 program controller permits programming time programs with real-time reference. It offers 25 program memory positions with up to 100 program sections each.

For each program section you can enter a temperature set-point, a pressure set-point, section duration, type of temperature and pressure transition (ramp or step), the switching states of the special controller functions and the tolerance ranges.



	If the safety controller has been set to "limit" mode, check the setting of the safety controller when changing the temperature set-point, (chap. 11.2).
---	--

Programming remains saved in case of a power failure or after turning off the unit.

Path: [Main menu](#) > [Programs](#) > [Time program](#)

16.1 Starting an existing time program

	In Normal display press the Program start icon to access the "Program start" menu.
---	---

Program start 🔒 10:17:27	
Program type	Time program
Program	Drying monitoring
Start section	
Program duration	
Program start	2019/09/23 10:17:23
Program end	2019/09/27 13:17:23
Program info	Before start: set the correct temperatur setpoint in manual mode
	

"Program start" menu

- In the field "Program type" select the setting "Time program".
- In the field "Program" select the desired program.
- Select the field "Program start" and enter the desired program start time in the "Program start" entry menu. Press the **Confirm** icon. The program delay time until program start begins.

The program end is adapted automatically depending on the entered program duration.

After completing the settings, press the **Confirm** icon to take over the entries and exit the menu. The program starts running.

If instead you press the **Close** icon to exit the menu without taking over the entries, the program will not start.

Program	program 1	Program runtime
<div style="background-color: grey; width: 100%; height: 10px;"></div>		00:01:23
		
		
		

Normal display. Information on the bottom of the screen indicates the currently running program and the time already passed. The grey bar shows how much time of the whole time is elapsed. If program duration has been set to infinite, the grey bar is not displayed.

16.1.1 Performance during program delay time

During the configured program delay time until program start, the controller equilibrates to the current setpoints of Fixed value operation mode. Modifications of these setpoints are effective. When the configured moment for program start is reached, the program delay time ends and the program starts running.



16.2 Stopping a running time program

16.2.1 Pausing a running time program

	Press the Program pause icon to interrupt the program..
---	--

The program is paused. The program runtime stops running down, the time display flashes.

There are the following options:

	Press the Program start icon to continue the program
	Press the Cancelling icon to cancel the program

16.2.2 Cancelling a running time program

	Press the Program cancelling icon to cancel the program.
--	---

A confirmation prompt is displayed. Press the **Confirm** icon to confirm that the program shall really be cancelled.

After confirming the message, the controller changes to Fixed value operation mode. Temperature and humidity will then equilibrate to the setpoints of Fixed value operation mode.

16.3 Performance after the end of the program

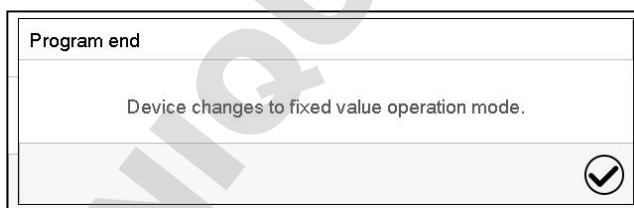

After the end of the program the message "Device changes to fixed value operation mode" appears on the screen.

Press the **Confirm** icon.

As long as the message has not been confirmed, the setpoint of the last program section remains effective. Program the last section as desired. If e.g. temperature and pressure control shall turn off, activate the corresponding controller functions (chap. 8.5.2, 8.6.2).

After confirming the message the controller changes to Fixed value operation mode. Temperature and humidity will then equilibrate to the setpoints of Fixed value operation mode.

16.4 Creating a new time program

Path: *Main menu > Programs > Time program*

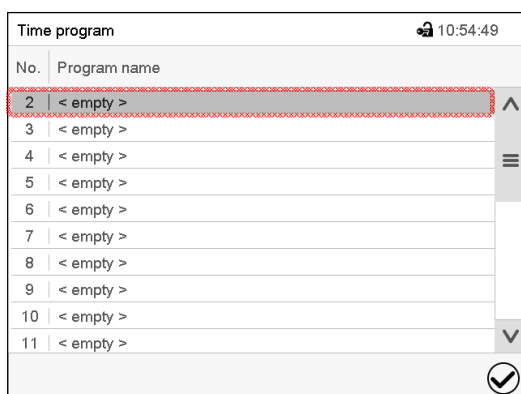

“Time program” menu:
overview of the existing programs.
Select an empty program place.

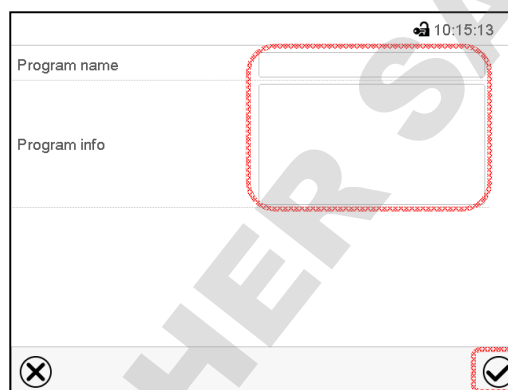

Enter the program name and, if desired,
additional program information in the
corresponding fields.

Press the **Confirm** icon.

The program view opens (chap. 16.5).

16.5 Program editor: program management

Path: *Main menu > Programs > Time program*

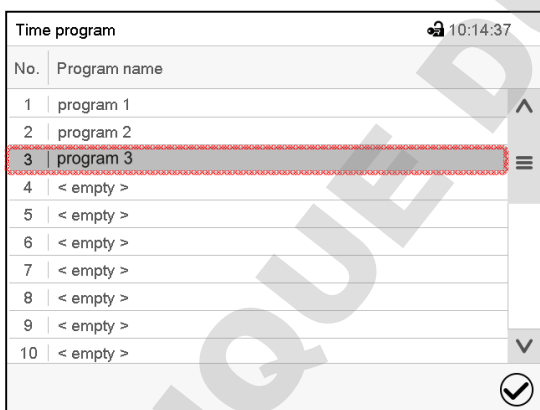

“Time program” menu:
overview of the existing programs.
Select an existing program (example: program
3) or create a new program (chap. 16.4).
The program view opens.

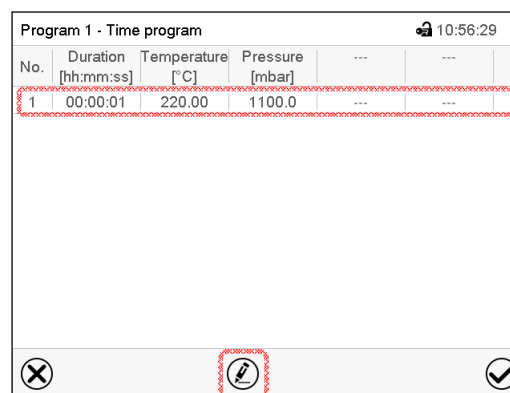

Program view (example: program 3).

If a new program has been created, there is
just one program section.

There are the following options:

- ① Select a program section to open the
section editor (chap. 16.6)
- ② Press the **Edit** icon to open the program
editor

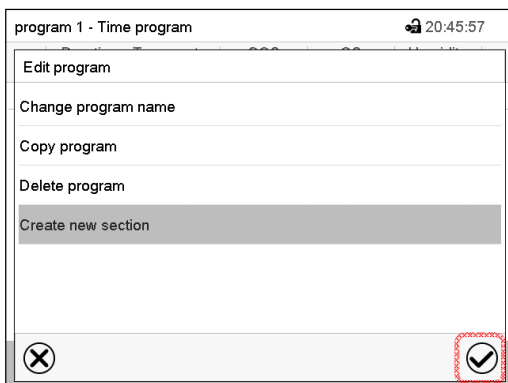

Program editor: "Edit program" menu
 Select the desired function and press the **Confirm** icon.

The program editor offers following options:

- Change the program name
- Copy program
- Replace program: Replacing an new or an existing program with the copied program. This menu point is visible only after a program has been copied.
- Delete program
- Create new section

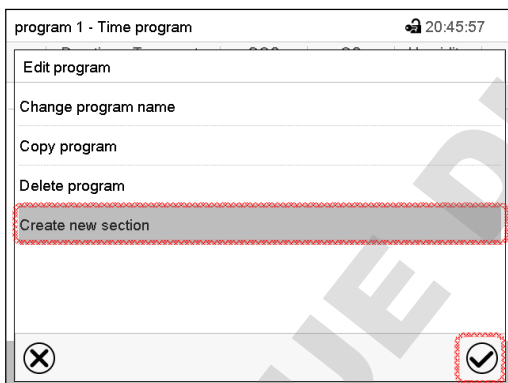

To add a new section, select "Create new section" and press the **Confirm** icon.
 The program view opens.

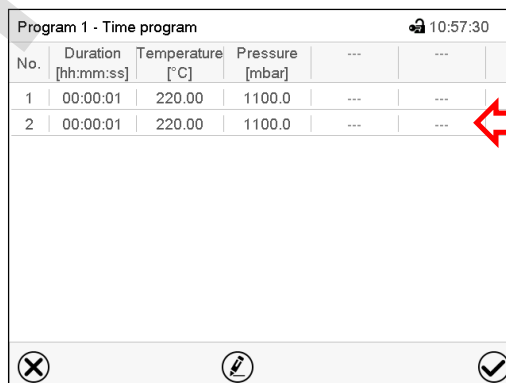

Program view.
 A new section is always added at the very bottom (example: section 2).

16.5.1 Deleting a time program

Path: **Main menu > Programs > Time program**

In the "Time program" menu select the program to be deleted. The program view opens.

- ➔ In the **program view** press the **Edit** icon to open the program editor
- ➔ In the **program editor** select "Delete program" and press the **Confirm** icon.
 The program is deleted. The controller returns to the program view.

16.6 Section editor: section management

Path: *Main menu > Programs > Time program*

Select the desired program.

Program 1 - Time program 10:57:30

No.	Duration [hh:mm:ss]	Temperature [°C]	Pressure [mbar]	---	---
1	00:00:01	220.00	1100.0	---	---
2	00:00:01	220.00	1100.0	---	---

✕ ✎ ✓

Program view.

Select the desired program section (example: section 1)

Program 1 - Section number 1 11:39:57

Duration 00:00:01

Course Ramp ①

Functions on/off 0000000000000000 ②

Number of repetitions 0

Start section for repetition 1

Temperature +220.00

Tolerance band min. +0.0000

Tolerance band max. +0.0000

Pressure +1100.0 ②

✕ ✎ ✓

Section view (example: section 1).

There are the following options:

- ① Select a parameter to enter or modify the according value (chap. 16.7)
- ② Press the **Edit** icon to open the program editor

program 3 - Section number 1 11:01:06

Edit section

Copy section

Delete section

Add new section

✕ ✓

Section editor: "Edit section" menu

Select the desired function and press the **Confirm** icon.

The section editor offers following options:

- Copy section
- Replace section: Replacing an existing section with the copied section. This menu point is visible only after a section has been copied.
- Insert section: Adding the copied section. This menu point is visible only after a section has been copied.
- Delete section
- Add new section

16.6.1 Add a new program section

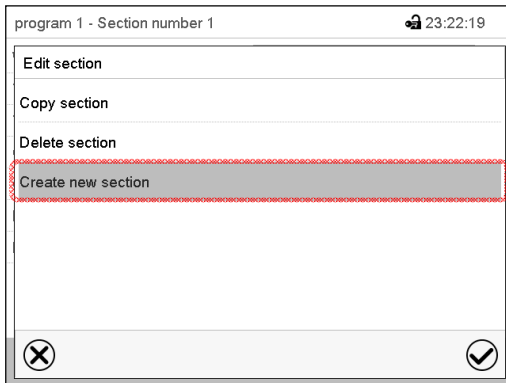

Section editor: "Edit section" menu.

Select "Create new section" and press the **Confirm** icon.

Then select whether to insert the new section before or after the current section.

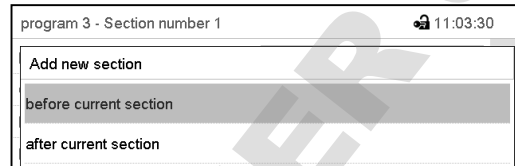

Press the **Confirm** icon. The new section opens.

16.6.2 Copy and insert or replace a program section

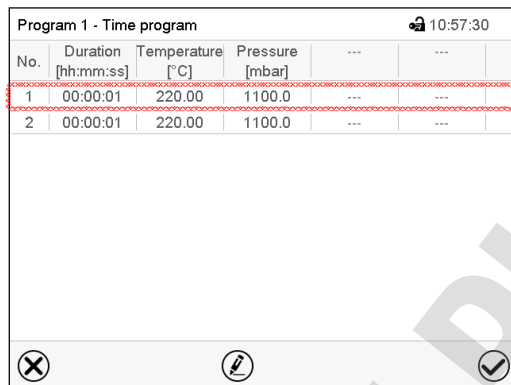

Program view.

Select the program section to be copied (example: section 1)

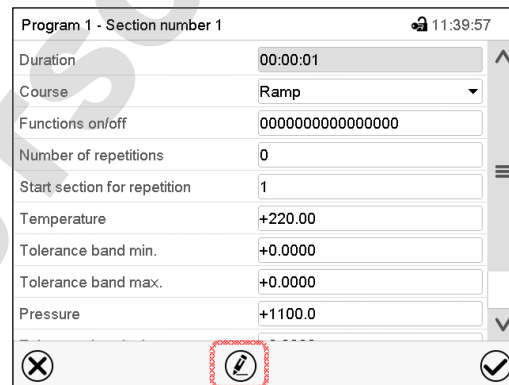

Section view (example: section 1).

Press the **Edit** icon to open the section editor.

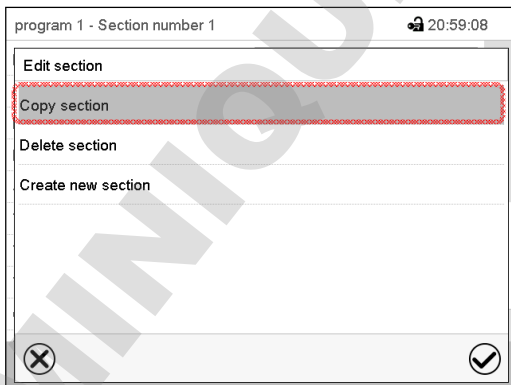

Section editor: "Edit section" menu

Select "Copy section" and press the **Confirm** icon.

The current section (example: section 1) is copied. The controller returns to the section view.

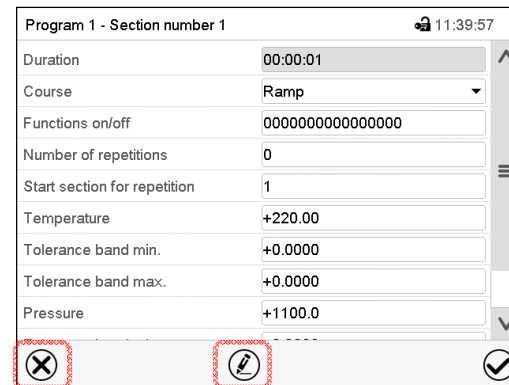

Section view (example: section 1).

Press the **Close** icon to change to the program view, if you want to select another section to be replaced or before or after which the copied section shall be inserted...

or

Press the **Edit** icon to open the section editor if you want the current section to be replaced or the copied section to be inserted before or after it

Program 1 - Time program						10:57:30
No.	Duration [hh:mm:ss]	Temperature [°C]	Pressure [mbar]	---	---	
1	00:00:01	220.00	1100.0	---	---	
2	00:00:01	220.00	1100.0	---	---	

Program view.

Select the section to be replaced or before or after which the copied section shall be inserted (example: section 2) and press the **Confirm** icon.

Program 1 - Section number 1		11:39:57
Duration	00:00:01	▲
Course	Ramp	▼
Functions on/off	0000000000000000	
Number of repetitions	0	
Start section for repetition	1	
Temperature	+220.00	
Tolerance band min.	+0.0000	
Tolerance band max.	+0.0000	
Pressure	+1100.0	▼

Section view (example: section 1).

Press the **Edit** icon to open the section editor

Program 1 - Section number 1		11:48:00
Edit section		
Copy section		
Replace section		
Insert section		
Delete section		
Create new section		

Section editor: "Edit section" menu

Select "Replace section" to replace the selected section with the copied section

or

Select "Insert section" to additionally add the copied section.

In this case select whether to insert it before or after the selected section.

Insert section
before current section
after current section

Press the **Confirm** icon

16.6.3 Deleting a program section

In the **program view** select the program section to be deleted. The section view opens.

➡ In the **section view** press the **Edit** icon to open the section editor

➡ In the **section editor** select "Delete section" and press the **Confirm** icon.

The section is deleted. The controller returns to the section view.

16.7 Value entry for a program section

Path: **Main menu > Programs > Time program**

Select the desired program and section.

The section view gives access to all parameters of a program section. You can enter or modify the values.

	<table border="1"> <tr><th colspan="2">Program name and section number</th></tr> <tr><td>Section duration</td><td></td></tr> <tr><td>Type of setpoint transition: ramp or step</td><td></td></tr> <tr><td>Special controller function</td><td></td></tr> <tr><td colspan="2">Repeating one or several sections within a program</td></tr> <tr><td>Temperature setpoint</td><td></td></tr> <tr><td colspan="2">Temperature tolerance range: minimum and maximum</td></tr> <tr><td>Pressure setpoint</td><td></td></tr> <tr><td colspan="2">Pressure tolerance range: minimum and maximum</td></tr> </table>	Program name and section number		Section duration		Type of setpoint transition: ramp or step		Special controller function		Repeating one or several sections within a program		Temperature setpoint		Temperature tolerance range: minimum and maximum		Pressure setpoint		Pressure tolerance range: minimum and maximum	
Program name and section number																			
Section duration																			
Type of setpoint transition: ramp or step																			
Special controller function																			
Repeating one or several sections within a program																			
Temperature setpoint																			
Temperature tolerance range: minimum and maximum																			
Pressure setpoint																			
Pressure tolerance range: minimum and maximum																			

The setting and control ranges for the individual parameters are the same as for "Fixed value" operating mode.

16.7.1 Section duration

Section view (partial view).

Select the field "Duration" indicating the time.

"Duration" entry menu.

Enter the desired section duration with the arrow keys and press the **Confirm** icon.

Setting range: 0 up to 99 hours 59 min 59 sec.

16.7.2 Set-point ramp and set-point step

You can define the type of temperature and pressure transitions for each individual program section.

“Ramp” mode: Gradual changes of temperature and pressure

The set-point of a given program section functions as the section’s start temperature. During the section’s duration, the set-point gradually passes to the set-point of the subsequent program section. The actual value follows the continually changing set-point.

If the last program section is in “ramp” mode and the setpoint shall change within this section, then you must program an additional section (with the shortest possible section duration) to provide the target temperature of the last program section. Otherwise, the setpoint would remain constant during the section’s duration.

Programming in the “ramp” mode allows all kinds of temperature and humidity transitions:

- Gradual changes of temperature and pressure

The setpoint changes its value gradually during the entered section duration. The actual value follows the continually moving set-point at any time.

- Program sections with constant temperature and pressure

The setpoints (initial values) of two subsequent program sections are identical; so the temperature and pressure remain constant during the entire duration of the first program section.

- Sudden changes of temperature and pressure

Steps can be programmed in ramp mode as temperature or humidity changes (ramps) that occur during a very short interval. If the duration of this transitional program section is very short (minimum entry 1 sec), the temperature or humidity change will proceed rapidly within the minimum amount of time.

“Step” mode: Sudden changes of temperature and pressure

The set-point of any program section functions as the section’s target value. At the start of the program section, the unit heats up and evacuates / ventilates the chamber with the maximum speed to reach the entered value; and then it holds it for the remaining section time. Therefore the set-point temperature remains constant for the section’s duration. These changes occur rapidly within the minimum amount of time (minimum entry: 1 second).

Programming in the “step” mode allows only two kinds of temperature and pressure transitions:

- Programming gradual changes of temperature and humidity (ramps) is impossible in the “step” mode
- Program sections with constant temperature and pressure

The setpoints (target values) of two subsequent program sections are identical; so the temperature and pressure remain constant during the entire duration of the first program section.

- Sudden changes of temperature and pressure

The entered setpoint of the section is reached as fast as possible and then held constant for the remaining section duration.

Selecting the setting “Ramp” or “Step”

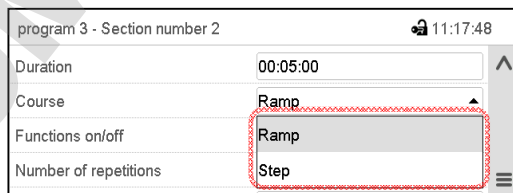

program 3 - Section number 2		11:17:48
Duration	00:05:00	^
Course	Ramp	▲
Functions on/off	Ramp	
Number of repetitions	Step	☰

Section view (partial view).

In the field “Course” select the desired setting “Ramp” or “Step”.

“Ramp” and “Step” mode example (representation of a temperature course)

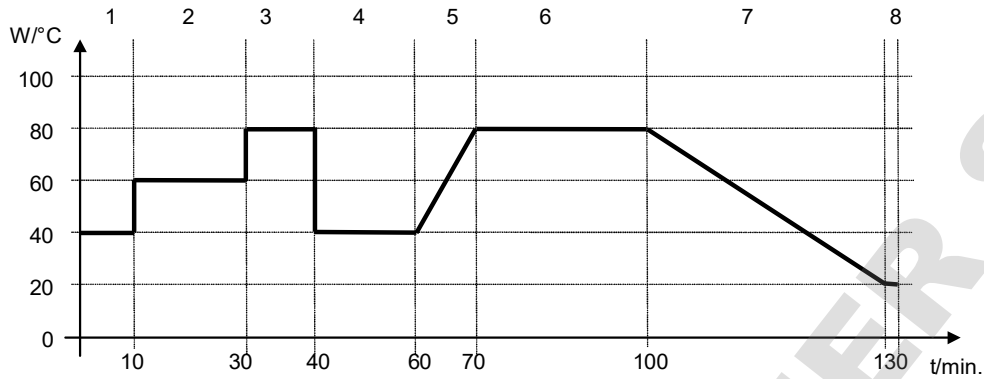

Corresponding program table

Section No.	Duration [hh:mm:ss]	Temperature [°C]	Pressure mbar]	Ramp or Step
1	00:10:00	40.0	xxxx	Step
2	00:20:00	60.0	xxxx	Step
3	00:10:00	80.0	xxxx	Step
4	00:20:00	40.0	xxxx	Step
5	00:10:00	40.0	xxxx	Ramp
6	00:30:00	80.0	xxxx	Ramp
7	00:30:00	80.0	xxxx	Ramp
8	00:00:01	20.0	xxxx	Ramp

16.7.3 Special controller functions

In the **“Functions on/off”** menu you can define the switching state of three controller functions.

- Function “Standby” (chap. 6.2)
- Function “GAS/AIR 2” (chap. 8.3)
- Function “Close all valves” (chap. 8.4)
- Function “Vacuum pump off” (chap. 8.2)

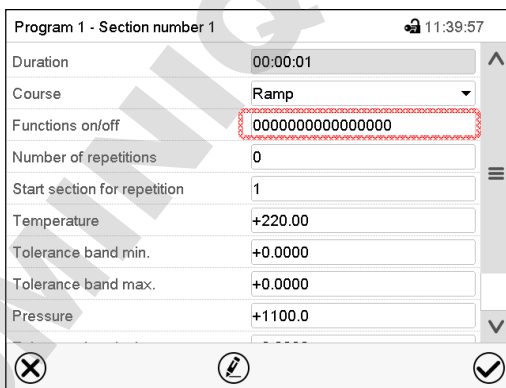

Section view.

Select the field “Functions on/off”.

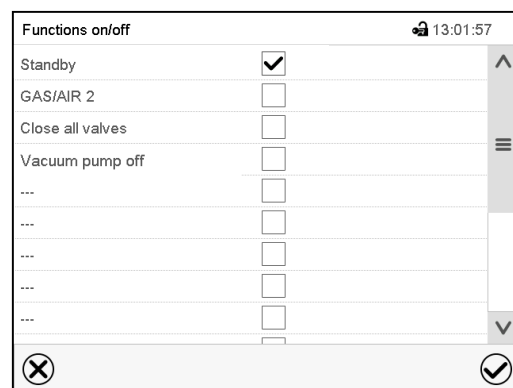

“Functions on/off” entry menu.

Mark / unmark the checkbox of the desired function to activate / deactivate it and press the **Confirm** icon.

The controller returns to the section view.

Program 1 - Section number 1	
Functions on/off	0000000000000001
Number of repetitions	0
Start section for repetition	1
Temperature	+220.00
Tolerance band min.	+0.0000
Tolerance band max.	+0.0000
Pressure	+1100.0
Tolerance band min.	+0.0000
Tolerance band max.	+0.0000

Section view indicating the controller functions.

The functions are displayed from right to left.

Activated function: switching status "1" (On)

Deactivated function: switching status "0" (Off)

Example:

Activated function "Standby" = 0000000000000001

Deactivated function "Standby" = 0000000000000000

16.7.4 Setpoint entry

- Select the field "Temperature" and enter the desired temperature setpoint.
Setting range: 0.0 °C up to 220.0 °C
Confirm entry with **Confirm** icon. The controller returns to the section view.
- Select the field "Pressure" and enter the desired pressure setpoint.
Setting range: 0 mbar up to 1100 mbar
Confirm entry with **Confirm** icon. The controller returns to the section view.



16.7.5 Tolerance range

You can specify a temperature and pressure program tolerance range for each program section with different values for the tolerance minimum and maximum. When the actual value exceeds the given threshold, the program is interrupted. This is indicated on the display (see below). When the actual temperature is situated again within the entered tolerance limits, the program automatically continues. Therefore, the duration of the program may be extended due to the programming of tolerances.

	Programming of tolerances may extend program duration.
---	--

An entry of "-99999" for the tolerance minimum means "minus infinite" and an entry of "999999" for the tolerance maximum means "plus infinite". Entry of these values will never lead to program interruption. The entry of "0" for the tolerance minimum and/or maximum deactivates the respective tolerance function.

When requesting rapid value transitions, we recommend not programming tolerance values in order to enable the maximum heating-up speed.

Program 1 - Section number 1		🔒 11:39:57
Duration	00:00:01	▲
Course	Ramp	▼
Functions on/off	0000000000000000	
Number of repetitions	0	☰
Start section for repetition	1	
Temperature	+220.00	
Tolerance band min.	+0.0000	
Tolerance band max.	+0.0000	
Pressure	+1100.0	▼
  		

Section view, showing the temperature tolerance range

- Select the field “Tolerance band min” and enter the desired lower tolerance band value. Setting range: -99999 to 99999. Confirm entry with **Confirm** icon. The controller returns to the section view.
- Select the field “Tolerance band max” and enter the desired upper tolerance band value. Setting range: -99999 to 99999. Confirm entry with **Confirm** icon. The controller returns to the section view.

Set the tolerance ranges for other parameters accordingly, if desired.

If one of the actual values (temperature and/or pressure) is outside the program tolerance range the whole program course is interrupted. During this program interruption time the controller equilibrates to the set-points of the current section.

The screen header indicates “Program pause (tolerance band)”. The program runtime indication flashes and does not proceed any further.



When the temperature or pressure values are back within the entered program tolerance range, the program continues automatically.

16.7.6 Repeating one or several sections within a time program

You can repeat several subsequent sections together. It is not possible to define the start section the same time also as the target section, therefore you cannot repeat a single individual section.

Enter the desired number of repetitions in the field „Number of repetitions“ and the number of the section to start the repetition cycle with in the field “Start section for repetition” To have sections repeated infinitely, enter the number of repetitions as “-1”.

The selected sections are repeated as many times as selected. Then the program continues.

Program 1 - Section number 1		🔒 11:39:57
Duration	00:00:01	▲
Course	Ramp	▼
Functions on/off	0000000000000000	
Number of repetitions	0	☰
Start section for repetition	1	
Temperature	+220.00	
Tolerance band min.	+0.0000	
Tolerance band max.	+0.0000	
Pressure	+1100.0	▼
  		

Section view, showing the repetition function

- Select the field “Number of repetitions” and enter the desired number of repetitions. Setting range: 1 to 99, and -1 for infinite. Confirm entry with **Confirm** icon. The controller returns to the section view.
- Select the field “Start section for repetition” and enter the section number, at which the repetition should start. Setting range: 1 up to the section before the currently selected section. Confirm entry with **Confirm** icon. The controller returns to the section view.

16.7.7 Saving the time program

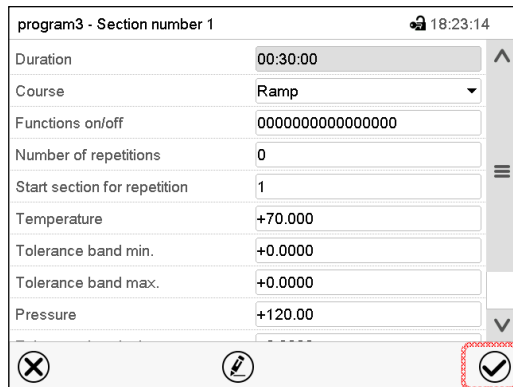

program3 - Section number 1 18:23:14

Duration 00:30:00

Course Ramp

Functions on/off 0000000000000000

Number of repetitions 0

Start section for repetition 1

Temperature +70.000

Tolerance band min. +0.0000

Tolerance band max. +0.0000

Pressure +120.00

Section view (sample values).

After the all desired values of the program section have been configured, press the **Confirm** icon to take over the programming. The controller changes to the program view.

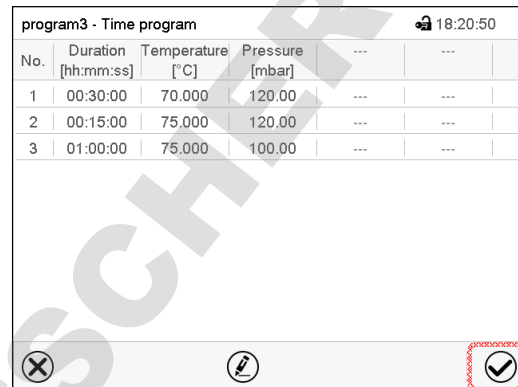
program3 - Time program 18:20:50

No.	Duration [hh:mm:ss]	Temperature [°C]	Pressure [mbar]
1	00:30:00	70.000	120.00
2	00:15:00	75.000	120.00
3	01:00:00	75.000	100.00

Program view (sample program).

Press the **Confirm** icon to take over the programming. The controller changes to the Normal display.



To save the programming it is absolutely required to press the Confirm icon. Otherwise all settings will be lost! There is no confirmation prompt!

17. MB2 controller: Week programs

The MB2 program controller permits programming week programs with real-time reference. It offers 5 week program places in total with up to 100 shift points for each week program.

Path: [Main menu](#) > [Programs](#) > [Week program](#)

For each program section you can enter the moment in time, the temperature set-point, the pressure set-point, and the switching states of the special controller functions.

17.1 Starting an existing week program

 In Normal display press the **Program start** icon to access the “Program start” menu.

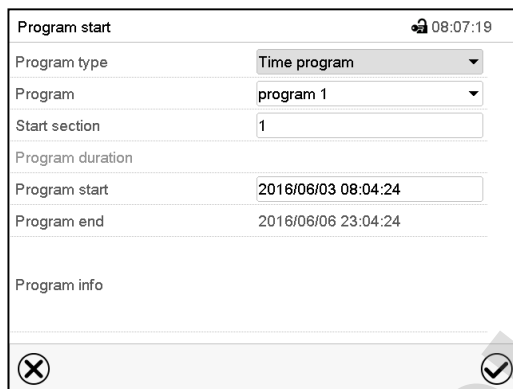

“Program start” menu.

- In the field “Program type” select the setting “Week program”.
- In the field “Program” select the desired program.
- There are no further settings available in the “Program start” menu for week programs, as they are needed only for time programs.

After completing the settings, press the **Confirm** icon to take over the entries and exit the menu. The program starts running.

If instead you press the **Close** icon to exit the menu without taking over the entries, the program will not start.

After starting the week program, the previously entered week program setpoints are active and will be equilibrated according to the current time.



Information on the bottom of the screen indicates the currently running program.

17.2 Cancelling a running week program

 Press the **Program cancelling** icon to cancel the program.

A confirmation prompt is displayed. Press the **Confirm** icon to confirm that the program shall really be cancelled.

After confirming the message the controller changes to Fixed value operation mode. Temperature and humidity will then equilibrate to the setpoints of Fixed value operation mode.

17.3 Creating a new week program

Path: *Main menu > Programs > Week program*

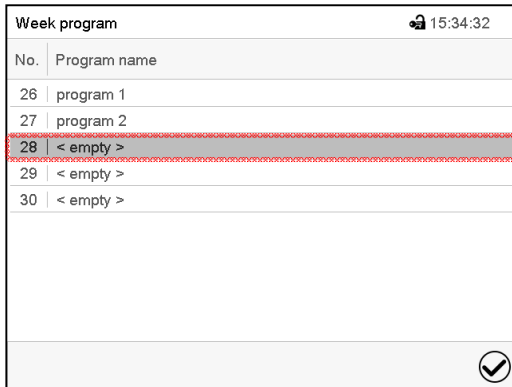

“Week program” menu:
overview of the existing programs.
Select an empty program place.

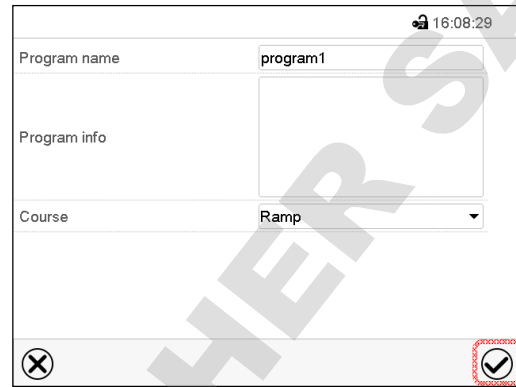

Enter the program name and, if desired,
additional program information in the
corresponding fields.
Select the set-point course “Ramp” or “Step”
(chap. 17.6.1).
Press the **Confirm** icon. The program view
opens.

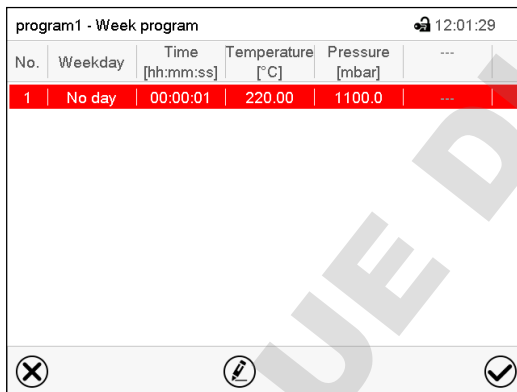

Program view.
For the first section no weekday is specified.
Therefore the section is first marked in red
and cannot be saved.

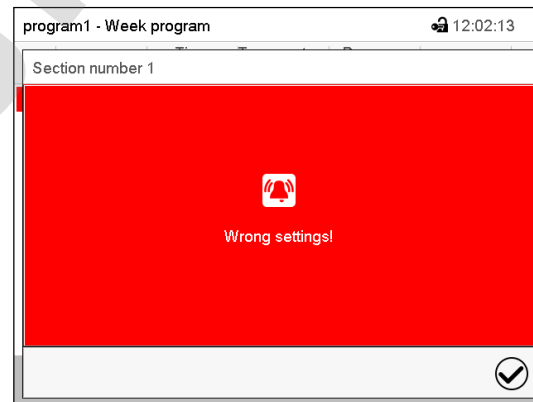

Error message when attempting to save the
program

To enter the values, select the program section which is marked in red. You will have access to the **Section view** where you can enter the values of the selected section (chap. 17.6).

17.4 Program editor: program management

Path: *Main menu > Programs > Week program*

Week program	
No.	Program name
26	program 1
27	program 2
28	< empty >
29	< empty >
30	< empty >

“Week program” menu: overview of the existing programs. Select an existing program (example: program 1).

program1 - Week program					
No.	Weekday	Time [hh:mm:ss]	Temperature [°C]	Pressure [mbar]	...
1	Monday	08:00:00	60.000	100.00	...
2	Monday	14:00:00	40.000	500.00	...

Program view (example: program 1). If a new program has been created, there is just one program section.

There are the following options:

- ① Select a program section to open the section editor (chap. 17.4.1)
- ② Press the **Edit** icon to open the program editor

program 1 - Week program	
Edit program	
Change program name	
Copy program	
Delete program	
Create new section	

Program editor: “Edit program” menu. Select the desired function and press the **Confirm** icon.

The program editor offers following options:

- Change program name. This menu also offers to configure the ramp / step mode setting (chap. 17.6.1).
- Copy program
- Replace program: Replacing an new or an existing program with the copied program. This menu point is visible only after a section has been copied.
- Delete program
- Create new section

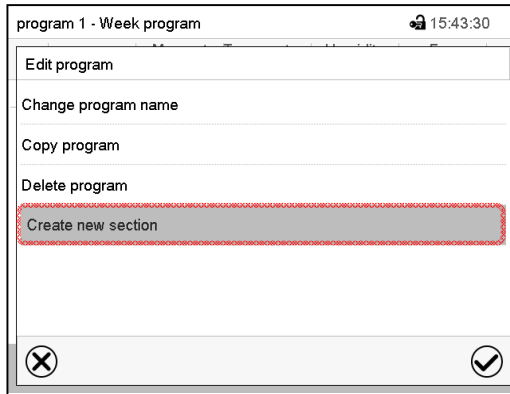

To add a new section, select “Create new section” and press the **Confirm** icon.
The program view opens.

No.	Weekday	Time [hh:mm:ss]	Temperature [°C]	Pressure [mbar]	...
1	Monday	08:00:00	60.000	100.00	...
2	No day	00:00:01	220.00	1100.0	...

Program view.

With a new section no weekday is specified. Therefore the section is first marked in red and cannot be saved.

A new section is always added at the very bottom (example: section 3). When the section start is specified the sections are automatically arranged in the correct chronological order.

17.4.1 Deleting a week program

Path: [Main menu](#) > [Programs](#) > [Week program](#)

In the “Week program” menu select the program to be deleted. The program view opens.

- In the **program view** press the **Edit** icon to open the program editor
- In the **program editor** select “Delete program” and press the **Confirm** icon.
The program is deleted. The controller returns to the program view.

17.5 Section editor: section management

Path: **Main menu > Programs > Week program**

Select the desired program.

program1 - Week program 12:13:10

No.	Weekday	Time [hh:mm:ss]	Temperature [°C]	Pressure [mbar]	...
1	Monday	08:00:00	60.000	100.00	---
2	Monday	14:00:00	40.000	500.00	---

✕  ✓

Program view.

Select the desired program section (example: section 2)



program1 - Section number 2 12:12:31

Weekday: Monday 1

Time: 14:00:00

Temperature: +40.000 2

Pressure: +500.00

Functions on/off: 0000000000000000

✕  ✓

Section view (example: section 2).

There are the following options:

- 1 Select a parameter to enter or modify the according value (chap. 17.6)
- 2 Press the **Edit** icon to open the program editor



Program 1 - Section number 1 11:39:57

Duration: 00:00:01

Course: Ramp

Functions on/off: 0000000000000000

Number of repetitions: 0

Start section for repetition: 1

Temperature: +220.00

Tolerance band min.: +0.0000

Tolerance band max.: +0.0000

Pressure: +1100.0

✕  ✓

Section editor: "Edit section" menu

Select the desired function and press the **Confirm** icon.

The section editor offers following options:

- Copy section
- Replace section: Replacing an existing section with the copied section. This menu point is visible only after a section has been copied.
- Insert section: Adding the copied section. This menu point is visible only after a section has been copied.
- Delete section
- Create new section

17.5.1 Add a new program section

Program 1 - Section number 1 11:39:57

Duration 00:00:01

Course Ramp

Functions on/off 0000000000000000

Number of repetitions 0

Start section for repetition 1

Temperature +220.00

Tolerance band min. +0.0000

Tolerance band max. +0.0000

Pressure +1100.0

Section editor: "Edit section" menu.
 Select "Create new section" and press the **Confirm** icon.

program1 - Week program 12:11:12

No.	Weekday	Time [hh:mm:ss]	Temperature [°C]	Pressure [mbar]	...
1	Monday	08:00:00	60.000	100.00	...
2	No day	00:00:01	220.00	1100.0	...

Program view.
 With a new section no weekday is specified. Therefore the section is first marked in red and cannot be saved.
 A new section is always added at the very bottom (example: section 3). When the section start is specified the sections are automatically arranged in the correct chronological order.

17.5.2 Copy and insert or replace a program section

program 1 - Section number 1 20:59:08

Edit section

Copy section

Delete section

Create new section

Section editor: "Edit section" menu
 Select "Copy section" and press the **Confirm** icon.
 The current section (example: section 1) is copied.
 The controller returns to the program view.

program1 - Week program 12:13:10

No.	Weekday	Time [hh:mm:ss]	Temperature [°C]	Pressure [mbar]	...
1	Monday	08:00:00	60.000	100.00	...
2	Monday	14:00:00	40.000	500.00	...

Program view
 Select the section to be replaced or before or after which the copied section shall be inserted (example: section 2).
 Press the **Confirm** icon
 The controller returns to the section editor

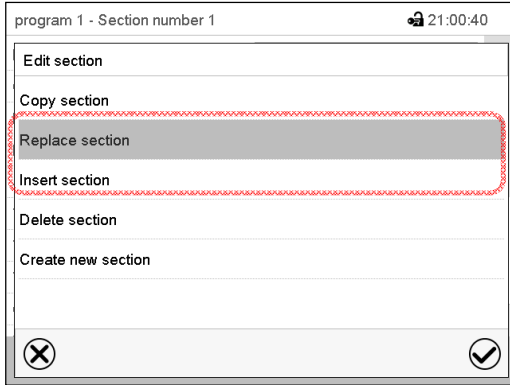

Section editor: "Edit section" menu

Select "Replace section" to replace the selected section with the copied section

or

Select "Insert section" to additionally add the copied section.

Press the **Confirm** icon.

If you selected "Insert section" the sections are automatically arranged in the correct chronological order.

17.5.3 Deleting a program section

In the **program view** select the program section to be deleted. The section view opens.

➡ In the **section view** press the **Edit** icon to open the section editor

➡ In the **section editor** select "Delete section" and press the **Confirm** icon.
The section is deleted. The controller returns to the section view.

17.6 Value entry for a program section in the Section view

Path: [Main menu](#) > [Programs](#) > [Week program](#)

Select the desired program and section.

17.6.1 Set-point ramp and set-point step modes

The explanation of the settings "Ramp" or "Step" is given in chap. 16.7.2.

You can define the type of temperature and pressure transitions for the entire week program.

Select the desired program and press the **Edit** icon to open the program editor. In the program editor select the "Change program name" function and press the **Confirm** icon.



"Change program name" menu.

In the field "Course" select the desired setting "Ramp" or "Step" and press the **Confirm** icon.

17.6.2 Weekday

Section view.

In the field “Weekday” select the desired weekday.

With “Daily” selected, this section will run every day at the same time.

17.6.3 Start time

Section view.

Select the field “Moment”.

Entry menu “Moment”.

Select with the arrow keys the desired start moment of the section and press the **Confirm** icon.

17.6.4 Setpoint entry

Section view.

- Select the field “Temperature” and enter the desired temperature setpoint.
Setting range: 0.0 °C up to 220.0 °C
Confirm entry with **Confirm** icon. The controller returns to the section view.
- Select the field “Pressure” and enter the desired pressure setpoint.
Setting range: 0 mbar up to 1100 mbar
Confirm entry with **Confirm** icon. The controller returns to the section view.

17.6.5 Special controller functions

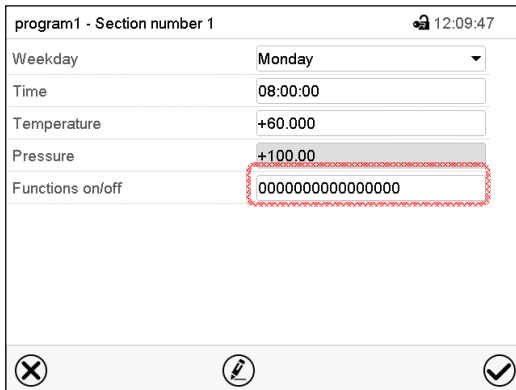

Section view.

In the “**Functions on/off**” menu you can define the switching state of three controller functions.

- Function “Standby” (chap. 6.2)
- Function “GAS/AIR 2” (chap. 8.3)
- Function “Close all valves” (chap. 8.4)
- Function “Vacuum pump off” (chap. 8.2)

For details please refer to chap. 16.7.3.

After the all desired values of the program section have been configured, press the **Confirm** icon. The controller changes to the program view

18. Network and communication

18.1 RD4 controller: Ethernet network settings

The settings in the **Ethernet** submenu are used for networking chambers with an Ethernet interface, e.g. to connect them with BINDER’s APT-COM™ 4 Multi Management Software (option, chap. 23.1).

18.1.1 Showing the network settings

Required access level: “User”.

The “Ethernet” submenu offers to subsequently or individually access the following information:

- MAC address
- IP address
- Subnet mask
- Standard gateway
- DNS server address
- DNS chamber name

18.1.1.1 Showing the chamber’s MAC address

Path: **Normal display** [v] [v] [v] **Chamber info** [OK] [v] [v] [v] [v] **Ethernet** [OK] **MAC address**

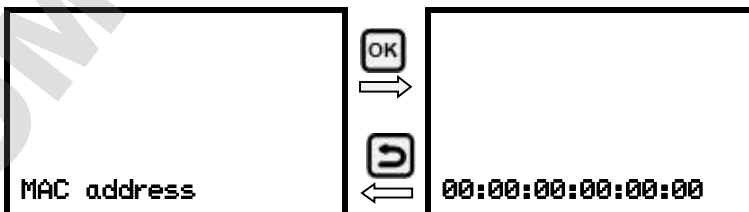

Display of the MAC address (example)
Toggle forth and back with the **Back button** and the **OK button**.

With the **arrow-down button** you can now change to the next parameter (IP address).

With the **Back button** you can go back to the “**Ethernet**” submenu and, repeatedly pressing it, to **Normal display**.

18.1.1.2 Showing the IP address

Path: **Normal display** ▾ ▾ ▾ **Chamber info** **Ethernet** **IP address**

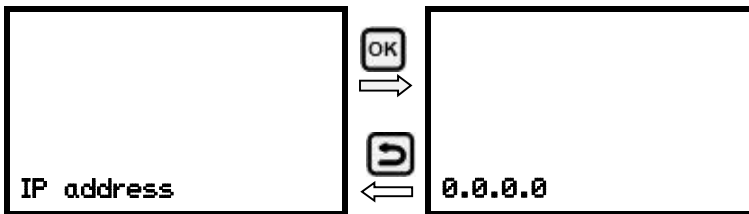

Display of the IP address (example)
Toggle forth and back with the **Back button** and the **OK button**.

With the **arrow-down button** you can now change to the next parameter (subnet mask).

With the **Back button** you can go back to the “**Ethernet**” submenu and, repeatedly pressing it, to **Normal display**.

18.1.1.3 Showing the subnet mask

Path: **Normal display** ▾ ▾ ▾ **Chamber info** **Ethernet** **Subnet mask**

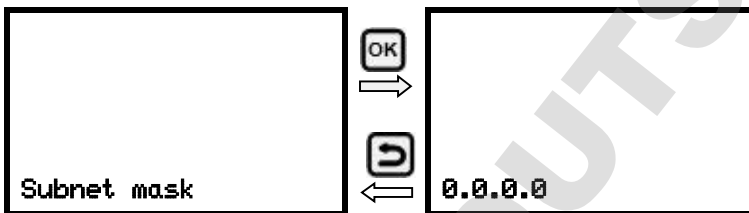

Display of the subnet mask (example)
Toggle forth and back with the **Back button** and the **OK button**.

With the **arrow-down button** you can now change to the next parameter (standard gateway).

With the **Back button** you can go back to the “**Ethernet**” submenu and, repeatedly pressing it, to **Normal display**.

18.1.1.4 Showing the standard gateway

Path: **Normal display** ▾ ▾ ▾ **Chamber info** **Ethernet** **Standard gateway**

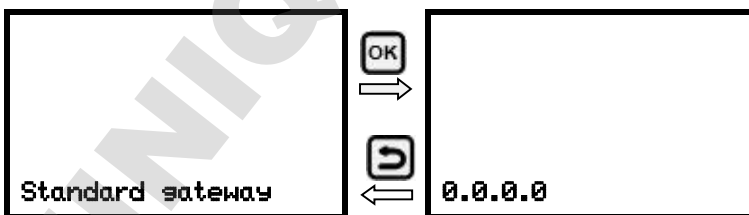

Display of the standard gateway (example)
Toggle forth and back with the **Back button** and the **OK button**.

With the **arrow-down button** you can now change to the next parameter (DNS server address).

With the **Back button** you can go back to the “**Ethernet**” submenu and, repeatedly pressing it, to **Normal display**.

18.1.1.5 Showing the DNS server address

Path: **Normal display** ▾ ▾ ▾ **Chamber info** **Ethernet** **DNS server address**



With the **arrow-down button** you can now change to the next parameter (DNS chamber name).

With the **Back button** you can go back to the “**Ethernet**” submenu and, repeatedly pressing it, to **Normal display**.

18.1.1.6 Showing the DNS chamber name

Path: **Normal display** ▾ ▾ ▾ **Chamber info** **Ethernet** **DNS chamber name**



With the **Back button** you can go back to the “**Ethernet**” submenu and, repeatedly pressing it, to **Normal display**.

18.1.2 Changing the configuration of the network settings

Required access level: “Admin”.

The “**Ethernet**” submenu offers to subsequently or individually access the following settings:

- Selecting the type of assignment (automatic or manual) of the IP address, chap. 18.1.2.1

If automatic IP address assignment has been selected:

- Selecting the type of assignment (automatic or manual) of the DNS server address, chap. 18.1.2.2.

If manual IP address assignment has been selected:

- Assigning the IP address, chap.18.1.2.3
- Assigning the subnet mask, chap. 18.1.2.4
- Assigning the standard gateway, chap. 18.1.2.5

If manual IP address assignment or manual DNS server address assignment has been selected:

- Assigning the DNS server address, chap. 18.1.2.6

18.1.2.1 Selecting the type of IP address assignment (automatic / manual)

Path: **Normal display**     **Settings**   **Ethernet**  **IP address assignment**

Press the **OK button** to enable the setting



Selection of the type of assignment of the IP address.

The current setting flashes. Use the **arrow buttons** to select between AUTO (automatic) and MANU (manual).

Confirm the setting with the **OK button**.

With the **arrow-down button** you can now change to the next parameter.

- If manual IP address assignment has been selected: assign the IP address (chap.18.1.2.3)
- If automatic IP address assignment has been selected: select the type of assignment of the DNS server address (chap. 18.1.2.2)

With the **Back button** you can go back to the “**Ethernet**” submenu and, repeatedly pressing it, to **Normal display**.

18.1.2.2 Selecting the type of assignment of the DNS server address (automatic / manual)

Access to this function is possible only if automatic IP address assignment has been selected (chap. 18.1.2.1)

Path: **Normal display**     **Settings**   **Ethernet**    **DNS server**

Press the **OK button** to enable the setting.



Selection of the type of assignment of the DNS server address.

The current setting flashes. Use the **arrow buttons** to select between AUTO (automatic) and MANU (manual).

Confirm the setting with the **OK button**.

If manual assignment of the DNS server address has been selected, you can now change with the **arrow-down button** to assign the DNS server address (chap. 18.1.2.6)

With the **Back button** you can go back to the “**Ethernet**” submenu and, repeatedly pressing it, to **Normal display**.

18.1.2.3 Assigning the IP address

Access to this function is possible only if manual IP address assignment has been selected (chap. 18.1.2.1)

Path: **Normal display**     **Settings**   **Ethernet**    **IP address**

Press the **OK button** to enable the setting.

The IP address entry is done in four steps, corresponding to the number sections: (1).(2).(3).(4)

Principle of entry:

- Use the **OK button** to select the desired section of the IP address 1/4, 2/4, 3/4, 4/4 in the upper display line
- Use the **Arrow buttons** to enter the value for the selected section of the IP address



IP address assignment (sample values).

The first section of the IP address is shown. Enter the desired value with the **arrow buttons**.

Use the **OK button** to confirm the entry and proceed to the second section of the IP address.

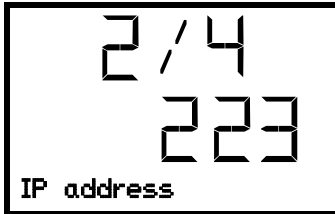

IP address assignment (sample values).

The second section of the IP address is shown. Enter the desired value with the **arrow buttons**.

Use the **OK button** to confirm the entry and proceed to the third section of the IP address.



IP address assignment (sample values).

The third section of the IP address is shown. Enter the desired value with the **arrow buttons**.

Use the **OK button** to confirm the entry and proceed to the last section of the IP address.



IP address assignment (sample values).

The fourth section of the IP address is shown. Enter the desired value with the **arrow buttons**.

Confirm the setting with the **OK button**.

With the **arrow-down button** you can now change to the enter the subnet mask.

With the **Back button** you can go back to the “Ethernet” submenu and, repeatedly pressing it, to **Normal display**.

18.1.2.4 Setting the subnet mask

Access to this function is possible only if manual IP address assignment has been selected (chap. 18.1.2.1)

Path: **Normal display** **Settings** **Ethernet** **Subnet mask**

Press the **OK button** to enable the setting.

The subnet mask entry is done in four steps, corresponding to the number sections: (1).(2).(3).(4)

Principle of entry:

- Use the **OK button** to select the desired section of the subnet mask 1/4, 2/4, 3/4, 4/4 in the upper display line
- Use the **Arrow buttons** to enter the value for the selected section of the subnet mask

For details please refer to the description of the similar procedure in chap.18.1.2.3 “Assigning the IP address”.

With the **arrow-down button** you can now change to the enter the standard gateway.

With the **Back button** you can go back to the “Ethernet” submenu and, repeatedly pressing it, to **Normal display**.

18.1.2.5 Setting the standard gateway

Access to this function is possible only if manual IP address assignment has been selected (chap. 18.1.2.1)

Path: **Normal display**     **Settings**   **Ethernet**      **Standard gateway**

Press the **OK button** to enable the setting.

The standard gateway entry is done in four steps, corresponding to the number sections: (1).(2).(3).(4)

Principle of entry:

- Use the **OK button** to select the desired section of the standard gateway 1/4, 2/4, 3/4, 4/4 in the upper display line
- Use the **Arrow buttons** to enter the value for the selected section of the standard gateway
- For details please refer to the description of the similar procedure in chap.18.1.2.3 “Assigning the IP address”.

With the **arrow-down button** you can now change to the assign the DNS server address.

With the **Back button** you can go back to the “**Ethernet**” submenu and, repeatedly pressing it, to **Normal display**.

18.1.2.6 Assigning the DNS server address

Access to this function is possible if manual IP address assignment (chap. 18.1.2.1) or manual DNS server address assignment (chap. 18.1.2.2) has been selected.

With manual IP address assignment:

Path: **Normal display**     **Settings**   **Ethernet**      **DNS server address**

With manual DNS server address assignment:

Path: **Normal display**     **Settings**   **Ethernet**    **DNS server address**

Press the **OK button** to enable the setting.

The DNS server address entry is done in four steps, corresponding to the number sections: (1).(2).(3).(4)

Principle of entry:

- Use the **OK button** to select the desired section of the DNS server address 1/4, 2/4, 3/4, 4/4 in the upper display line
- Use the **Arrow buttons** to enter the value for the selected section of the DNS server address
- For details please refer to the description of the similar procedure in chap.18.1.2.3 “Assigning the IP address”.

With the **Back button** you can go back to the “**Ethernet**” submenu and, repeatedly pressing it, to **Normal display**.

18.2 MB2 controller

For the network and communication settings at least the "Admin" authorization level is required.

18.2.1 Ethernet

18.2.1.1 Configuration

Path: [Main menu](#) > [Settings](#) > [Ethernet](#)

Ethernet 10:56:59	
IP address assignment	Automatic (DHCP)
IP address	
Subnet mask	
Standard gateway	
DNS device name	MAC000CD809E33F-TYP7035€
DNS server address	Automatic
DNS server	

"Ethernet" submenu.

- In the field "IP address assignment" select the desired setting "Automatic (DHCP)" or "Manual".

IP address assignment	Automatic (DHCP)
IP address	Manual
Subnet mask	Automatic (DHCP)

With selection "Manual" you can enter the IP-address, the subnet mask and the standard gateway manually.

IP address assignment	Manual
IP address	223.223.223.1
Subnet mask	255.255.255.0
Standard gateway	0.0.0.0

- Select "DNS device name" and enter the DNS device name. Confirm entry with **Confirm** icon.
- In the field "DNS server address" select the desired setting "Automatic" or "Manual".

Standard gateway	Manual
DNS device name	Automatic
DNS server address	Automatic

With selection „Manual" you can enter the DNS server address manually.

DNS server address	Manual
DNS server	0.0.0.0

After completing the settings, press the **Confirm** icon to take over the entries and exit the menu, **or** press the **Close** icon to exit the menu without taking over the entries.

18.2.1.2 Display of MAC address

Path: [Main menu](#) > [Device info](#) > [Ethernet](#)

Ethernet		🔒 13:49:56
Ethernet	Yes	^
MAC address	00-0C-D8-09-E3-3F	
IP address	192.168.14.87	
Subnet mask	255.255.255.0	
Standard gateway	192.168.14.1	☰
DNS server	192.168.10.5	
DNS device name	MAC000CD809E33F-TYP703596	v

⏪

“Ethernet” submenu (example).

18.2.2 Web server

This controller menu serves to configure the web server. Then you can enter the chamber's IP-address in the Internet. The IP address is available via [Chamber information](#) > [Ethernet](#). The BINDER web server opens. Enter the user name and password which have been assigned for the web server in the controller menu. This enables online access to the controller display, to see e.g., the event list or error messages. In this view no settings can be changed.

Path: [Main menu](#) > [Settings](#) > [Web server](#)

Web server		🔒 11:08:32
Password active	Yes	v
User name	admin	
Password	1234	
Automatic log out after	0 Min	

⊗

✔

“Webserver” submenu.

- In the field “Password active” select the desired setting “Yes” or “No”.

Password active	Yes
User name	No
Password	Yes

- Select the field “User name” and enter the desired user name. Confirm entry with **Confirm** icon.
- Select the field “Password” and enter the desired password. Confirm entry with the **Confirm** icon.
- Select the field “Automatic log out after” and enter the time in minutes after which the webserver shall log out automatically. Setting range: 0 min to 65535 min. Confirm entry with **Confirm** icon.

After completing the settings, press the **Confirm** icon to take over the entries and exit the menu, **or** press the **Close** icon to exit the menu without taking over the entries.

18.2.3 E-Mail

As soon as an alarm was triggered, an e-mail is sent to the configured e-mail address.

Path: **Main menu > Settings > Email**

E-mail address entry:

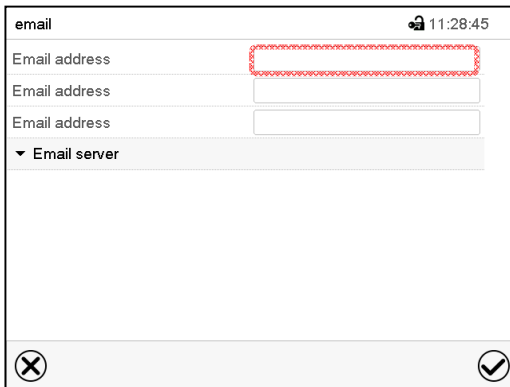

“Email” submenu.

Select the desired e-mail address field and enter the e-mail address. You can use the **Keyboard change** icon for entry. Confirm entry with **Confirm** icon.

E-mail server settings:

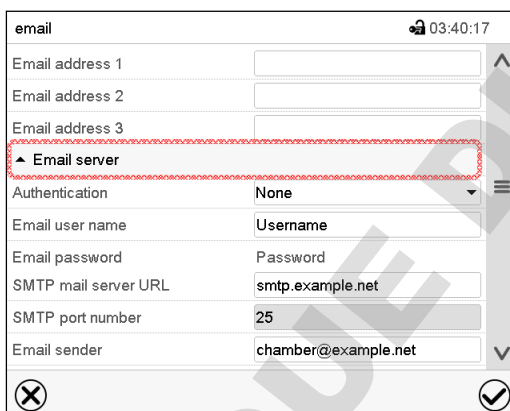

“Email” submenu.

Select the field “Email server” to access the settings

- In the field “Authentication” select the desired setting “None” or “SMTP” auth“.

With the setting “SMTP auth”, you can enter a password under “Email password”.

Authentication	None
Email user name	None
Email password	SMTP auth
SMTP mail server URL	192.168.10.45

- Select the field “Email user name” and enter the desired user name. Confirm entry with **Confirm** icon.
- Select the field “SMTP mail server URL” and enter the SMPT mail server URL. Confirm entry with **Confirm** icon.
- Select the field “SMTP port number” and enter the desired port number. Standard setting: “25”. Confirm entry with **Confirm** icon.
- Select the field “Email sender” and enter the desired Email sender. Confirm entry with **Confirm** icon.

After completing the settings, press the **Confirm** icon to take over the entries and exit the menu, **or** press the **Close** icon to exit the menu without taking over the entries.

19. RD4 controller: Data recorder

An internal data recorder saves chamber data and events in three data sets.

With the export function "Export recorder data" (chap. 20.1.3) you can save the three data sets via the USB interface to USB stick. They are issued in the selected language as a spreadsheet with the file extension ".csv" and can be further processed in the desired program. The data is unencrypted. Always the entire data memory is read out.

19.1 Recorded data

All data is given out in tabular form. The headlines of the values "number", "date", and "time" are given out in the selected language, all other information in English.

- **Chamber data for the user "DL1"**

Tabular representation of the actual temperature and pressure values together with the date and time, according to the set storage rate (chap. 19.3). Temperature values are always given out in °C.

- **Chamber data for BINDER Service "DL2"**

This data is intended for use by BINDER Service. It also contains information from the self-test function. The storage rate is fix (1 minute). Temperature values are always given out in °C.

- **Event list**

Messages regarding the controller and data memory as well as the alarm messages together with the date and time:

- Firmware update done
- "New config (USB)": New configuration uploaded via USB
- "Data recorder cleared" Data recorder and event list deleted via setup program
- Other event messages according to existing alarms
- The moment of switching the alarm state on and off is indicated under "On/Off".

19.2 Storage capacity

The storage capacity of the data recorder depends on the number of entries.

- DL1 = 110.000 entries (equaling 76 days with a storage rate of 1 minute, setting see chap. 19.3)
- DL2 = 27.000 entries (equaling 18 days with a fix storage rate of 1 minute)
- Event list: 200 events

The shorter the set storage rate, the closer are the stored measuring points, the more precise, but also shorter is the documented period.

Once the storage capacity of the data recorder is reached, overwriting of the oldest values begins

19.3 Setting the storage rate for the “DL1” recorder data

Required access level: “Admin”.

Path: **Normal display**     **Settings**    **Data recorder**  **Storage interval**

Press the **OK button** to enable the setting.

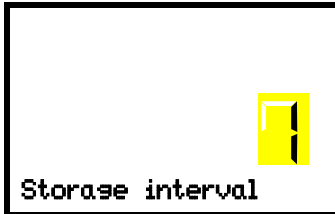

Function “Storage interval”.

The current setting flashes. Use the **arrow buttons** to enter the desired storage interval. Setting range: 1 minute to 60 minutes.

Press the **OK button** to confirm the setting.

With the **Back button** you can go back to the “**Data recorder**” submenu and, repeatedly pressing it, to **Normal display**.

19.4 Deleting the data recorder

When importing a configuration via USB stick (chap. 20.1.2) and when loading a new firmware version by BINDER service, the entire data memory is deleted.

BINDER service can also install the configuration by means of a setup program without deleting the data.

Regardless of this, BINDER Service can delete the data via a setup program.

Loading a new configuration via USB-Stick leads to deleting the data recorder.

	NOTICE
	<p>Danger of information loss when loading a new configuration. Data loss. ➤ Backup data on the USB stick prior to loading a new configuration.</p>

20. USB menu: Data transfer via USB interface

20.1 RD4 controller

A USB interface for data transfer via USB stick is located in the instrument panel (the second micro USB interface is only used by the manufacturer).

The controller offers an import function and three export functions through the USB interface:

Import function (chap. 20.1.2):

- Configuration data in file “KONF380.set”

Export functions (chap. 20.1.3):

- Configuration data in file “KONF380.set”
- Recorder data
 - DL1 (chamber data for the user): “DL1_[MAC address of the chamber].csv”
 - DL2 (chamber data for BINDER Service): “DL2_[MAC address of the chamber].csv”
 - Event list: “EvList_[MAC address of the chamber].csv”

For detailed information on the file content see chap. 19.1.

- Service data

The "Service" folder is created on the USB stick and can be sent to BINDER Service. In addition to the configuration and recorder data, it contains further service-relevant information.

20.1.1 Connecting the USB stick

Connect the USB stick to the interface located in the triangular instrument panel.



Connect only USB sticks to the USB interface.

After inserting the USB stick, the initial function "Import configuration" is displayed.

As long as the USB stick is connected, only the functions for data transfer are available. Other controller functions are only available after removing the USB stick.

20.1.2 Import function

Required access level: "Admin".



Function "Import configuration".
To import configuration data from the USB stick, press the **OK button**.

With the **arrow-down button** you can now change to the setting of the "Export configuration" function.

20.1.3 Export functions

Required access level: any user



Function "Export configuration".
To write the configuration data from the controller to the USB stick, press the **OK button**.

With the **arrow-down button** you can now change to the next function.



Function "Export recorder data".
To write the recorder data from the controller to the USB stick, press the **OK button**.

With the **arrow-down button** you can now change to the next function.



Function "Export service data".
To write the chamber data from the controller to the USB stick, press the **OK button**.

20.1.4 Ongoing data transfer

A moving arrow symbol indicates the progress of the data transfer.

Example:



Data recording is running.

Attention! Danger of data loss! Do not disconnect the USB stick from the device during ongoing data transfer!

After successful transfer, the controller shows again the initial function "Import configuration".

20.1.5 Error during data transmission

In the event of an error, the message ERR (error) is displayed.



Read error (example).

20.1.6 Removing the USB stick

Logging off the USB stick is not possible / required.

Be sure that no data recording is running (chap. 20.1.4).

After removing the USB stick, the controller is back in the same menu as before when connecting the USB stick.

20.2 MB2 controller

The USB port is located in the instrument panel.

When you insert a USB-stick, the "USB" menu opens.

Depending on the user's authorization level, different functions (highlighted in black) are available for the logged-in user.

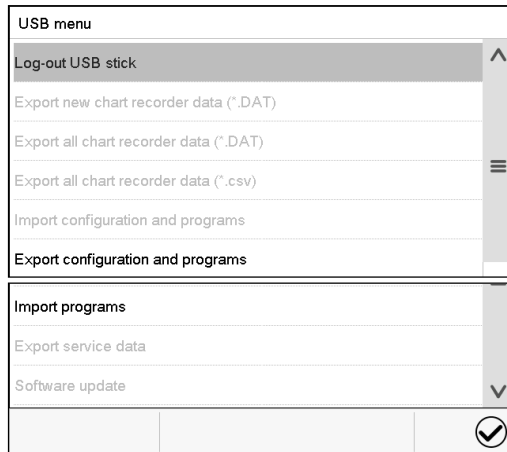

Available functions
with "User" authorization level

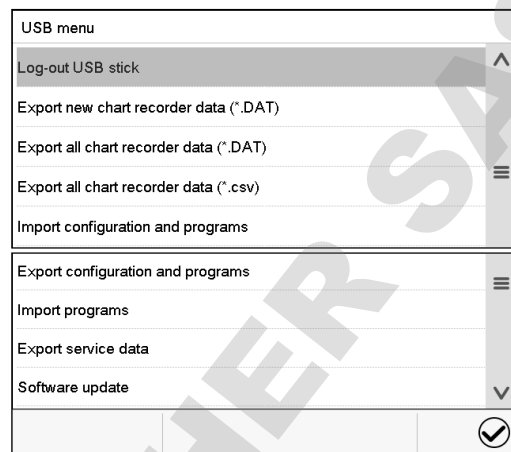

Available functions
with "Admin" authorization level

Function	Explanation
Log-out USB stick	Log-out USB stick bevor pulling it
Export new chart recorder data (*.DAT)	Export chart recorder data, which have been added since last export, in .dat format
Export all chart recorder data (*.DAT)	Export all chart recorder data in .dat format
Export all chart recorder data (*.csv)	Export all chart recorder data in .csv format
Import configuration and programs	Import configuration and timer / time / week programs
Export configuration and programs	Export configuration and timer / time / week programs
Import programs	Import timer / time / week programs
Export service data	Export service data
Software update	Controller firmware update

21. MB2 controller: Chart recorder display

This view offers graphic representation of the measurement course. Data representation imitates a chart recorder and allows recalling any set of measured data at any point of time taken from the recorded period.

21.1 Views

	Press the Change view icon to access the pen recorder display.
---	---

21.1.1 Show and hide legend

	Show legend		Hide legend
---	--------------------	---	--------------------

Press the **Show legend** icon to display the legend on the right side of the display

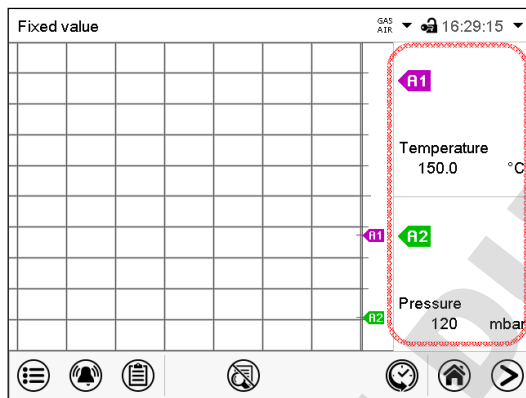

Legend shown on the right side of the display

21.1.2 History display

	History display
---	------------------------

Press the **History display** icon to change to the history display.

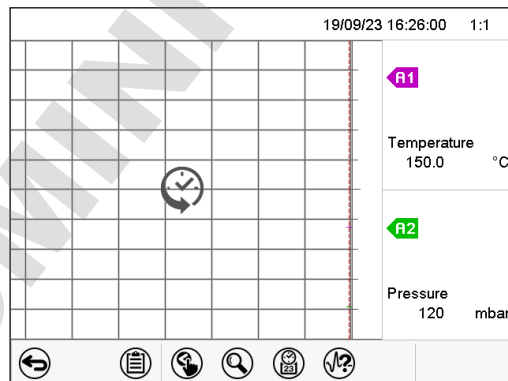

History display with legend shown.

The chart recorder is paused. Data recording continues in the background.

Move the central red line by tapping and holding to the desired position.

The legend at the right side shows the values of the current line position.

Then further icons appear:

History display: Curve selection

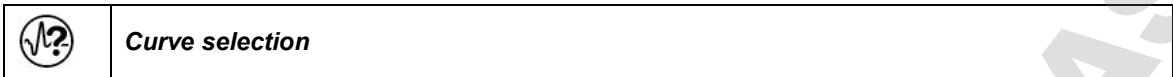

Press the **Curve selection** icon to access the “Curve selection” submenu.

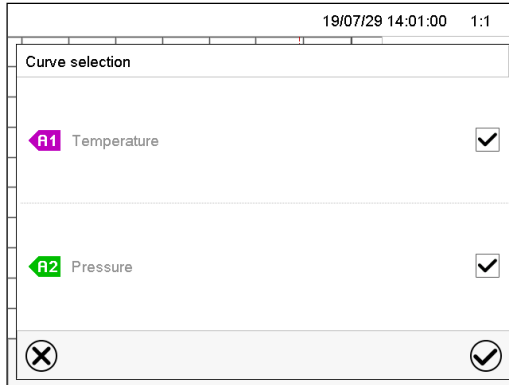

“Curve selection” submenu.

Select the curves to be displayed by checking the checkbox of the corresponding parameter. Press the **Confirm** icon

History display: Search the required instant



Press the **Search** icon to access the “Search” submenu.

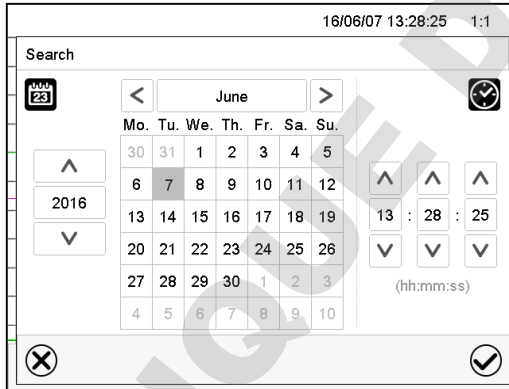

“Search” submenu.

Select the required instant by entering its date and time and press the **Confirm** icon

History display: Zoom function

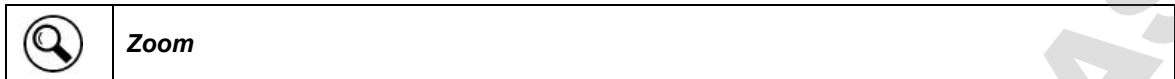

Press the **Zoom** icon to access the “Zoom” submenu.

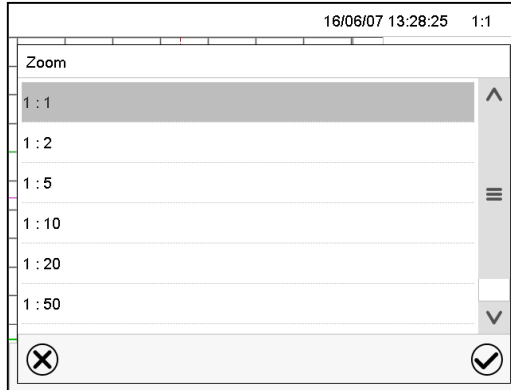

“Zoom” submenu.

Select the zoom factor and press the **Confirm** icon

History display: Show and hide scroll buttons to scroll to an instant



Press the **Show scroll buttons** icon to access the “Page selection” submenu.

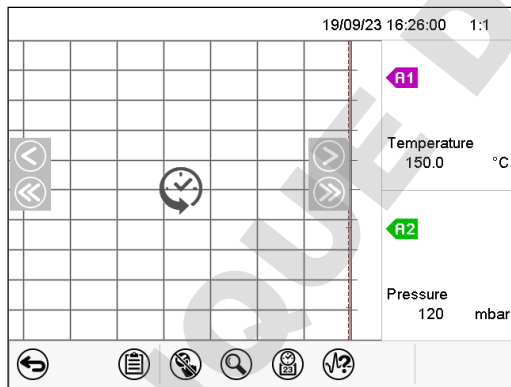

“Page selection” submenu.

Scroll buttons are shown on the left and on the right. Use them to move along the timeline.

21.2 Setting the parameters

This menu allows setting the storage interval, the type of values to be shown and the scaling of the temperature and humidity charts.

Path: **Main menu > Settings > Measurement chart**

Measurement chart	
Storage interval	60 s
Storage values	Current values
Min. temperature °C	+0.0000 °C
Max. temperature °C	+300.00 °C
Min. pressure mbar	+0.0000 mbar
Max. pressure mbar	+1600.0 mbar

“Measurement chart” submenu.

- Select the field “Storage interval” and enter the desired storage interval. Confirm entry with **Confirm** icon.

The available presentation depends on the pre-selected storage rate. Factory setting: 60 seconds. This means the higher the storage rate, the more precisely but shorter the data representation will be.

- In the field “Storage values” select the desired value type to be displayed.

Storage interval	60 s
Storage values	Current values
Min. temperature °C	Mean values
Max. temperature °C	Current values
Min. pressure mbar	Min. value
Max. pressure mbar	Max. value

- For scaling the representation select the desired minimum and maximum temperature or pressure value and enter the desired values. Temperature display range: 0 °C up to 300 °C. Pressure display range: 0 mbar up to 1600 mbar. Confirm each entry with **Confirm** icon.

Setting the storage rate or rescaling (minimum and/or maximum) will clear the measured-value memory and the event list.

NOTICE	
	<p>Danger of information loss when setting the storage rate or rescaling. Data loss of measured-value memory and event list.</p> <p>➤ Change the storage rate or scaling ONLY if the previously registered data is no longer needed.</p>

After completing the settings, press the **Confirm** icon to take over the entries and exit the menu, **or** press the **Close** icon to exit the menu without taking over the entries.

22. Reference measurements

22.1 Checking the temperature in the inner chamber

The controller display was adjusted in the factory to the temperature in the center of the usable volume (chap. 27.1). The sensor probe of the reference measuring device was connected tightly to an expansion rack positioned in the middle of the chamber.

22.1.1 Checking the controller display

- Conduct the reference sensor into the inner chamber through the measuring port (12). The port must be largely vacuum tight to enable a typical operation vacuum for the calibration. For a high vacuum, use a measuring access port. Usually, a silicone plug with a hole for the sensor wire is sufficient.
- Fix the sensor to the center of an expansion rack in the middle of the useable volume with adhesive aluminum tape or thermal conductive paste to ensure sufficient thermal conductivity.
- Perform the measurement in a thermally stable condition with 3 expansion racks and empty oven.
- Equilibrating time: at least 12 hours.

22.1.2 Checking the spatial temperature exactitude

- Fix at least 9 sensor probes on 3 racks with adhesive aluminum tape or thermal conductive paste to ensure sufficient thermal conductivity
- The distance of the sensor probes to all inner chamber walls must be at least 10% of the corresponding inner chamber dimension (see DIN 12880:2007).
- Perform the measurement in a thermally stable condition with 3 expansion racks and empty oven.
- Response time: at least 12 hours.



Do NOT use the temperature probe of the reference measurement device without any contact to the expansion rack, i.e., do NOT measure vacuum values!



In case the temperature probe is a thermo element, mount it so it is electrically insulated from the rack.

If you note an excessive divergence between the controller and reference temperatures, please contact BINDER Service to calibrate the temperature controller.

23. Options

23.1 APT-COM™ 4 Multi Management software (Option)

The chamber is regularly equipped with an Ethernet interface (3) that can connect the BINDER APT-COM™ 4 Multi Management Software.

- RD4 controller: The MAC Address is indicated in the “Ethernet” controller menu (chap. 18.1.1.1).
- MB2 controller: MAC Address is indicated in the “Device info” controller menu (chap. 18.2.1.2).

The actual temperature and pressure values are given at adjustable intervals. Programming can be performed graphically via PC.

For chambers with RD4 controller, time and week programs can be created and transferred to the controller, which can then be started and stopped directly from the controller (chap. 14).

Up to 100 chambers can be cross-linked. For further information please refer to the APT-COM™ 4 operating manual.

23.2 Analog outputs for temperature and pressure (option)

With this option, the chamber is equipped with analog outputs 4-20 mA for temperature and pressure. These outputs allow transmitting data to external data registration systems or devices.

The connection is realized as a 9-poles SUB-D socket “Analog output” (10) located in the VD rear control panel as follows:



ANALOG OUTPUT 4-20 mA DC

PIN 1: Temperature +

PIN 2: Temperature –

PIN 4: Pressure +

PIN 5: Pressure –

Temperature range: 0 °C to +220 °C

Pressure range: 0 mbar to 1100 mbar

A suitable plug is enclosed.

Figure 20: Pin configuration of the SUB-D socket „Analog output“ (10) for the analog outputs option

23.3 Measuring access port for vacuum, 9 poles (option)

The measuring access port allows creating electrical connections for low voltages or sensors between the exterior and interior of the VD vacuum drying oven. A 9 poles plug for the outside is included.

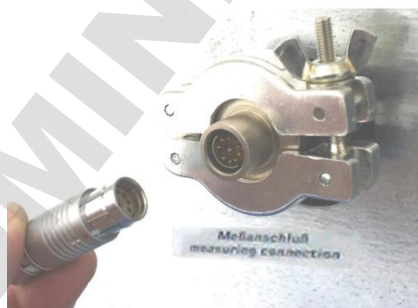



Figure 21: Measuring connection (12) with measuring access port and supplied plug

Connections at the measuring access port

- At the inner side of the measuring access port you can solder up to 9 cables. The inside connections must be insulated against each other and against ground. Use 300 °C / 572 °F solder.
- The 9 contacts are conducted outside via the measuring access port. You can use them to connect a device via the delivered plug.

Maximum load capacity of the switching contacts: 42 V AC/DC - 2A

	 DANGER
<p>Electrical hazard due to exceeding the load capacity of the switching contacts. Damage to switching contacts and connection socket. Deadly electric shock.</p> <p>Ø Do NOT exceed the maximum switching load of 42 AC/DC – 2Amp.</p> <p>Ø Do NOT connect any devices with a higher load capacity.</p> <p>➤ Insulate the inside connections against each other and against ground. Use 300 °C / 572 °F solder.</p>	

23.4 Object temperature display with flexible Pt 100 temperature sensor (option)

The object temperature display permits recording the object temperature directly on or in the drying material. This enables the determination of the actual temperature of the charging material during the whole process. The object temperature is measured via a flexible Pt100 sensor inside the inner chamber and can be viewed on the controller display. The sensor needs to be in thermally conducting contact with the charging material. It can be plunged into humid charging material up to the length of its protecting tube.

23.4.1 Connection of the object temperature sensor

- Insert the Pt 100 temperature sensor from the rear through the measuring connection (12) into the inner chamber.
- The 3 contacts of the Pt 100 sensor are conducted outside via a measuring access port. From there, establish the connection to the 9-poles SUB-D socket "Object temperature input" (9) in the VD rear control panel. Connect the supplied cable to the measuring access port and into SUB-D-socket (9).

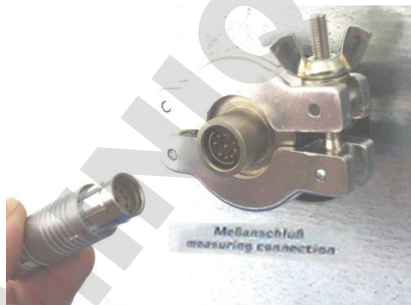

Figure 22: Measuring connection (12) with measuring access port

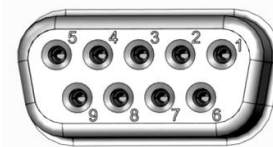

Figure 23: Sub D socket (9) "Object temperature input" in the VD rear control panel to connect the optional Pt 100 sensor

Technical data of the Pt 100 sensor:

- Three-wire technique
- Class B (DIN EN 60751)
- Temperature range up to 320 °C / 608 °F
- Stainless steel protective tube, length 45 mm / 1.77 in, stainless steel material no. 1.4501

23.4.2 Display on the RD4 controller

In Normal display, the current actual values and the measures object temperature values are shown alternately:

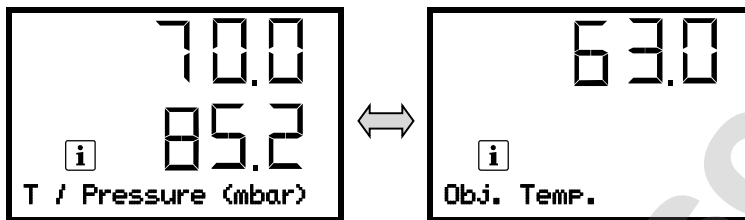

23.4.3 Display on the MB2 controller

Fixed value		Setpoint	Actual value
Temperature	°C	40.0	40.1
Pressure	mbar	1100	1024
Obj. Temp.	°C		10.6

Normal display with object temperature display (sample values)

The object temperature data are put out together with the data of the temperature controller to the chamber's interface and can be documented by the APT-COM™ 4 Multi Management Software (option, chap. 23.1) developed by BINDER.

23.5 LED interior lighting





The LED interior lighting provides optimal illumination of the interior, regardless of the lighting conditions in the environment.

It is turned on with a switch located in the triangular instrument panel.

24. Cleaning and decontamination

Clean the chamber after each use in order to prevent potential corrosion damage by ingredients of the loading material.

Prior to renewed startup, allow the chamber to completely dry after all cleaning and decontamination measures.

  	 DANGER
<p>Electrical hazard by water entering the chamber. Deadly electric shock.</p> <ul style="list-style-type: none"> ➤ Make sure that the chamber will not become wet during cleaning or decontamination. ⊘ Do NOT spill water or cleaning agents over the inner and outer chamber surfaces. ⊘ Do NOT put ANY cleaning aids (cloth or brush) into slots or openings on the chamber. ➤ Before cleaning, disconnect the power plug. Let the chamber cool down to ambient temperature. ➤ Completely dry the chamber before turning it on again. 	

24.1 Cleaning

Disconnect the oven from the power supply before cleaning. Disconnect the power plug.

	<p>The interior of the chamber must be kept clean. Thoroughly remove any residues of the charging material</p>
---	--

Wipe the surfaces with a moistened towel. In addition, you can use the following cleaning agents:

Exterior surfaces, inner chamber, door gaskets	Standard commercial cleaning detergents free from acid or halides. Alcohol based solutions. We recommend using the neutral cleaning agent Art. No. 1002-0016.
Expansion racks, rack holders	Standard commercial cleaning detergents free from acid or halides, no salt solution or chlorinated solvents. We recommend using the neutral cleaning agent Art. No. 1002-0016.
Controller housing (instrument panel)	Standard commercial cleaning detergents free from acid or halides. We recommend using the neutral cleaning agent Art. No. 1002-0016.
Zinc coated hinge parts rear chamber wall	Standard commercial cleaning detergents free from acid or halides. Do NOT use a neutral cleaning agent on zinc coated surfaces.

Do not use cleaning agents that may cause a hazard due to reaction with components of the device or the charging material. If there is doubt regarding the suitability of cleaning products, please contact BINDER service.

	<p>We recommend using the neutral cleaning agent Art. No. Art. 1002-0016 for a thorough cleaning.</p> <p>Any corrosive damage that may arise following use of other cleaning agents is excluded from liability by BINDER GmbH.</p> <p>Any corrosive damage caused by a lack of cleaning, is excluded from liability by BINDER GmbH.</p>
---	---

	NOTICE
	<p>Danger of corrosion by using unsuitable cleaners. Damage to the chamber.</p> <ul style="list-style-type: none"> ∅ Do NOT use acidic or chlorine cleaning detergents. ∅ Do NOT use a neutral cleaning agent on other kind of surfaces e.g., the zinc coated hinge parts or the rear chamber wall.

	<p>For surface protection, perform cleaning as quickly as possible. After cleaning completely remove cleaning agents from the surfaces with a moistened towel. Let the chamber dry.</p>
---	---







	<p>Soapsuds may contain chlorides and must therefore NOT be used for cleaning.</p>
---	--

	<p>With every cleaning method, always use adequate personal safety controls.</p>
---	--

Following cleaning, leave the chamber door open or remove the access port plugs.

	<p>The neutral cleaning agent may cause health problems in contact with skin and if ingested. Follow the operating instructions and safety hints labeled on the bottle of the neutral cleaning agent.</p>
---	--

Recommended precautions: To protect the eyes use sealed protective goggles. Wear gloves. Suitable protective gloves with full contact: butyl or nitrile rubber, penetration time >480 minutes.

    	 CAUTION
	<p>Danger of chemical burns through contact with skin or ingestion of the neutral cleaning agent. Skin and eye damage. Environmental damage.</p> <ul style="list-style-type: none"> ∅ Do not ingest the neutral cleaning agent. Keep it away from food and beverages. ∅ Do NOT empty the neutral cleaning agent into drains. ➤ Wear protective gloves and goggles. ➤ Avoid skin contact with the neutral cleaning agent.

24.2 Decontamination / chemical disinfection

The operator must ensure that proper decontamination is performed in case a contamination of the chamber by hazardous substances has occurred.

Disconnect the chamber from the power supply prior to chemical decontamination. Disconnect the power plug.

Do not use decontamination agents that may cause a hazard due to reaction with components of the device or the charging material. If there is doubt regarding the suitability of cleaning products, please contact BINDER service.

You can use the following disinfectants:

Inner chamber	Standard commercial surface disinfectants free from acid or halides. Alcohol based solutions. We recommend using the disinfectant spray Art. No. 1002-0022.
---------------	---

	For chemical disinfection, we recommend using the disinfectant spray Art. No. 1002-0022. Any corrosive damage that may arise following use of other disinfectants is excluded from liability by BINDER GmbH.
---	---

	With every decontamination / disinfection method, always use adequate personal safety controls.
---	---



In case of contamination of the interior by biologically or chemically hazardous material, there are two possible procedures depending on the type of contamination and charging material.

- (1) Vacuum drying ovens VD can be sterilized at 190 °C / 374 °F for at least 30 minutes. All inflammable goods must be removed from the interior before.
- (2) Remove the vacuum expansion racks and removable rack holders and spray the inner chamber with an appropriate disinfectant.

If desired you can sterilize the vacuum expansion racks and removable rack holders in a sterilizer or autoclave. Before start-up, the chamber must be absolutely dry and ventilated, as explosive gases may form during the decontamination process.

	In case of eye contact, the disinfectant spray may cause eye damage due to chemical burns. Follow the operating instructions and safety hints labeled on the bottle of the disinfectant spray.
--	--

Recommended precautions: To protect the eyes use sealed protective goggles.

	<div style="background-color: yellow; text-align: center; padding: 5px;"> CAUTION</div> <p>Danger of chemical burns through eye contact with the disinfectant spray.</p> <p>Eye damage. Environmental damage</p> <ul style="list-style-type: none"> ⊘ Do NOT empty the disinfectant into drains. ➤ Wear protective goggles.
---	---

	After using the disinfectant spray, allow the chamber to dry thoroughly, and aerate it sufficiently.
---	--

25. Maintenance and service, troubleshooting, repair, testing

25.1 General information, personnel qualification

- **Maintenance**

See chap. 25.3

- **Simple troubleshooting**

Chap. 25.2 describes troubleshooting by operating personnel. It does not require technical intervention into the chamber, nor disassembly of chamber parts.

For personnel requirements please refer to chap. 1.1.

- **Detailed troubleshooting**

If errors cannot be identified with simple troubleshooting, further troubleshooting must be performed by BINDER Service or by BINDER qualified service partners or technicians, in accordance with the description in the Service Manual.

For personnel requirements please refer to the Service Manual.

- **Repair**

Repair of the chamber can be performed by BINDER Service or by BINDER qualified service partners or technicians, in accordance with the description in the Service Manual.

After maintenance, the chamber must be tested prior to resuming operation.

- **Electrical testing**

To prevent the risk of electrical shock from the electrical equipment of the chamber, an annual repeat inspection as well as a test prior to initial startup and prior to resuming operation after maintenance or repair, are required. This test must meet the requirements of the competent public authorities. We recommend testing under DIN VDE 0701-0702:2008 in accordance with the details in the Service Manual.

For personnel requirements please refer to the Service Manual.

25.2 Simple troubleshooting



Defects and shortcomings can compromise the operational safety of the chamber and can lead to risks and damage to equipment and persons. If there are is a technical fault or shortcoming, take the chamber out of operation and inform BINDER Service. If you are not sure whether there is a technical fault, proceed according to the following list. If you cannot clearly identify an error or there is a technical fault, please contact BINDER Service.

	Only qualified service personnel authorized by BINDER must perform repair. Repaired chambers must comply with the BINDER quality standards.
---	--

Fault description	Possible cause	Required measures
General		
Chamber permanently turned off.	No power supply.	Check connection to power supply.
	Wrong voltage.	Check power supply for voltage of 115V or 230V.
	Chamber fuse has responded.	Check chamber fuse.
	Controller defective.	Contact BINDER Service.
Heating		
Chamber doesn't heat up.	Pt 100 sensor defective.	Contact BINDER service.
	Heating element defective.	
	Semiconductor relay defective	
Chamber doesn't heat up. Alarm message "Safety controller" on the controller display	Safety controller has responded: Inner chamber temperature has reached the safety controller value. Safety controller value set too low or temperature set-point too high, or error in the heating system.	Let the chamber cool down. Acknowledge the alarm on the controller. Check the settings of the temperature setpoint and safety controller value. If appropriate, select suitable safety controller value (chap. 11.2).
	Safety controller defective.	Contact BINDER service.
Chamber doesn't heat up. Alarm message "Overtemperature" on the controller display	Overtemperature protective device class 2 (thermal switch) activated. Error in the heating system.	Let the chamber cool down. Acknowledge the alarm on the controller and restart the chamber. If the error repeats, turn off the chamber and contact BINDER service.
Set-point temperature is not reached after specified time.	Chamber door not properly closed.	Completely close chamber door.
	Door gasket defective.	Replace door gasket,
	Controller not adjusted.	Calibrate and adjust controller.
Chamber heating permanently, set-point not maintained.	Controller defective.	Contact BINDER Service.
	Pt 100 sensor defective.	
	Semiconductor relay defective	
	Controller not adjusted.	Calibrate and adjust controller.
Deviations from the indicated heating-up times.	Oven fully loaded.	Charge the oven less or consider longer heating-up times.
Deviations from the temperature set-point in equilibrated state.	Invalid calibration	Use the delivered expansion racks only. Do NOT change between aluminum and stainless steel racks
Wrong temperature value measured during calibration.	Reference temperature sensor has insufficient contact to expansion rack.	Fix the reference temperature sensor with thermal conductive paste or adhesive aluminum tape.
	Leakage current when using a thermo element not electrically isolated.	Mount a thermo element electrically isolated from the rack.
Vacuum		
Vacuum not held.	Door gasket defective.	Replace door gasket,
	Safety glass panel defective.	Replace safety glass panel.
	Gaskets of small flange connections (universal eccentric ring) defective.	Replace gaskets of small flange connections.
	Inner tube connection leaky.	Contact BINDER Service.

Fault description	Possible cause	Required measures
Controller		
No chamber function (dark display).	Chamber is in standby mode.	Deactivate standby mode (chap. 6.2).
Menu functions not available.	Menu functions not available with current authorization level.	Log in with the required higher authorization.
		<i>MB2 controller:</i> Log in with the required higher authorization. or contact BINDER service to obtain an activation code (chap. 9.2.6).
No access to controller	Incorrect password.	Contact BINDER service.
Controller does not equilibrate to entered setpoints.	Temperature control is turned off	Turn on temperature control (chap. 8.5).
	Pressure control is turned off.	Turn on pressure control (chap. 8.6).
	<i>MB2 controller:</i> Set-points were entered in Fixed value operation mode. Controller is in program operation mode.	Change to Fixed value operation mode.
Pressure alarm when operating without a vacuum connection.	Pressure control turned on.	Turn off pressure control (chap. 8.6).
Acknowledging the alarm does not cancel the alarm state.	Cause of alarm persists.	Remove cause of alarm. If the alarm state continues, contact BINDER service.
Alarm message: - - - - or <-<-< or >>->	Sensor rupture between sensor and controller or Pt 100 sensor defective.	Contact BINDER service.
	Short-circuit.	
<i>MB2 controller:</i> Measured-value memory cleared in Chart recorder function, information lost.	New setting of storage rate or scaling (minimum and/or maximum) (chap. 21.2).	Change the storage rate or scaling ONLY if the previously registered data are no longer required.
MB2 controller: Program operation		
Controller does not equilibrate to program set-points.	Controller is not in program operation mode, or program delay time is running.	Start the program again. If appropriate, wait for the program delay time.
Program duration longer than programmed.	Tolerances have been programmed.	For rapid transition phases, do NOT program tolerance limits in order to permit maximum heating, evacuating, or ventilation speed.
Program keeps the last program setpoint constant while in setting "ramp".	Program line with setting "ramp" is incomplete.	When programming with setting "ramp", define the end value of the desired cycle by adding an additional section with a section time of at least one second.
Ramp temperature transitions are only realized as steps.	Setting "step" has been selected.	Select setting "ramp".

25.3 Maintenance intervals, service

 	 DANGER
	<p>Electrical hazard during live maintenance work. Deadly electric shock.</p> <ul style="list-style-type: none"> ∅ The chamber must NOT become wet during operation or maintenance work. ∅ Do NOT remove the rear panel of the chamber. ➤ Disconnect the power plug before conducting maintenance work. ➤ Ensure all maintenance work is conducted by licensed electricians or experts authorized by BINDER.

Ensure regular maintenance work is performed at least once a year.

	The warranty becomes void if maintenance work is conducted by non-authorized personnel.
---	---

	Replace the door gasket only when cold. Otherwise, the door gasket may become damaged.
---	--

We recommend taking out a maintenance agreement. Please consult BINDER Service.

BINDER telephone hotline:	+49 (0) 7462 2005 555
BINDER fax hotline:	+49 (0) 7462 2005 93555
BINDER e-mail hotline:	service@binder-world.com
BINDER service hotline USA:	+1 866 885 9794 or +1 631 224 4340 x3 (toll-free in the USA)
BINDER service hotline Asia Pacific:	+852 390 705 04 or +852 390 705 03
BINDER service hotline Russia and CIS:	+7 495 988 15 16
BINDER Internet website:	http://www.binder-world.com
BINDER address:	BINDER GmbH, post office box 102, D-78502 Tuttlingen

International customers, please contact your local BINDER distributor.

25.4 Service Reminder

25.4.1 RD4 controller

You can display the time until the service due in the controller. Keep the **OK button** pressed down for 5 seconds.

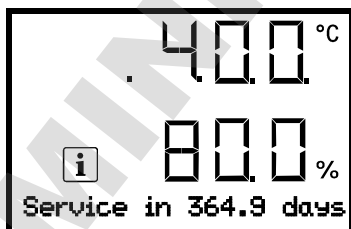

The remaining time in days until maintenance is due is shown in the text field of the controller display.
 Press the **OK button** to confirm the message.

After the recommended maintenance interval (one year of operation) a message appears on the controller.

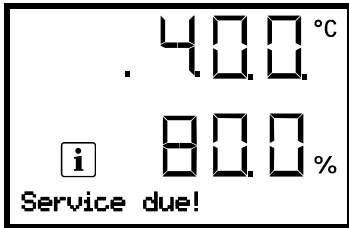

The message "Service due!" is shown in the text field of the controller display.
Press the **OK button** to confirm the message.

After one week of operation, the message reappears.

25.4.2 MB2 controller

After 8760 operating hours or two years the following message appears:

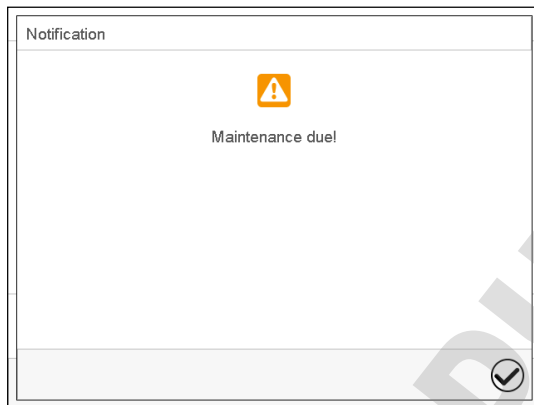

After confirmation with the **Confirm** icon, the message window will pop up again every two weeks until it is reset by BINDER Service.

25.5 Sending the chamber back to BINDER GmbH

If you return a BINDER product to us for repair or any other reason, we will only accept the product upon presentation of an **authorization number** (RMA number) that has previously been issued to you. An authorization number will be issued after receiving your complaint either in writing or by telephone **prior** to your sending the BINDER product back to us. The authorization number will be issued following receipt of the information below:

- BINDER product type and serial number
- Date of purchase
- Name and address of the dealer from which you bought the BINDER product
- Exact description of the defect or fault
- Complete address, contact person and availability of that person
- Exact location of the BINDER product in your facility
- A contamination clearance certificate (chap. 30) must be faxed in advance

The authorization number must be applied to the packaging in such a way that it can be easily recognized or be recorded clearly in the delivery documents.

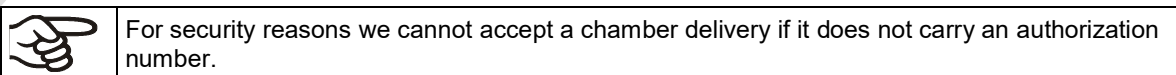

Return address: BINDER GmbH Gänsäcker 16
Abteilung Service 78502 Tuttlingen, Germany

26. Disposal

26.1 Disposal of the transport packing



Packing element	Material	Disposal
Straps to fix packing on pallet	Plastic	Plastic recycling
Wooden transport box (option) with metal screws	Non-wood (compressed matchwood, IPPC standard)	Wood recycling
	Metal	Metal recycling
Pallet with foamed plastic stuffing	Solid wood (IPPC standard)	Wood recycling
	PE foam	Plastic recycling
Shipping box with metal clamps	Cardboard	Paper recycling
	Metal	Metal recycling
Top cover	Cardboard	Paper recycling
Edge protection	Styropor® or PE foam	Plastic recycling
Protection of doors	PE foam	Plastic recycling
Bag for operating manual	PE foil	Plastic recycling
Insulating air cushion foil (packing of optional accessories)	PE foil	Plastic recycling

If recycling is not possible, all packing parts can also be disposed of with normal waste.

26.2 Decommissioning

- Disconnect the oven from the power supply. Disconnect the power plug.
- Turn off the inert gas supply.

Through the open inert gas connection, inert gas can enter the vacuum drying oven and escape into the ambient air.

	 DANGER
	<p>Risk of suffocation by inert gas in a high concentration. Death by suffocation.</p> <ul style="list-style-type: none"> ➤ Respect the relevant regulations for handling inert gases. ➤ When decommissioning the vacuum drying oven, turn off the inert gas supply.

- Turn off the vacuum pump. Ventilate the chamber as described in chap. 6.4.2
- Disconnect the oven from the power supply. Pull the power plug.
- Remove the vacuum connection (chap. 4.3).
- Remove the inert gas connection and the pressure reducer (chap. 4.5).

Temporal decommissioning: See indications for appropriate storage, chap. 3.3.

Final decommissioning: Dispose of the chamber as described in chap. 26.3 to 26.5.

26.3 Disposal of the chamber in the Federal Republic of Germany

According to Annex I of Directive 2012/19/EU of the European Parliament and of the Council on waste electrical and electronic equipment (WEEE), BINDER devices are classified as “monitoring and control instruments” (category 9) only intended for professional use“. They must not be disposed of at public collecting points.

The chambers bear the symbol for the marking of electrical and electronic equipment manufactured / placed on the market in the EC after 13 August 2005 and be disposed of in separate collection according to Directive 2012/19/EU on waste electrical and electronic equipment (WEEE) and German national law for electrical and electronic equipment (Elektro- und Elektronikgerätegesetz, ElektroG). WEEE marking: crossed-out wheeled bin with solid bar under. A significant part of the materials must be recycled in order to protect the environment.

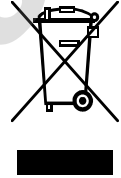



At the end of the device's service life, have the chamber disposed of according to the German national law for electrical and electronic equipment (Elektro- und Elektronikgerätegesetz, ElektroG from 20 October 2015, BGBl. I p. 1739) or contact BINDER service who will organize taking back and disposal of the chamber according to the German national law for electrical and electronic equipment (Elektro- und Elektronikgerätegesetz, ElektroG from 20 October 2015, BGBl. I p. 1739).

NOTICE	
	<p>Danger of violation against existing law if not disposed of properly.</p> <ul style="list-style-type: none"> ⊘ Do NOT dispose of BINDER devices at public collecting points. ➤ Have the device disposed of professionally at a recycling company which is certified according to the German national law for electrical and electronic equipment (Elektro- und Elektronikgerätegesetz, ElektroG from 20 October 2015, BGBl. I p. 1739). <li style="text-align: center;"><i>or</i> ➤ Instruct BINDER Service to dispose of the device. The general terms of payment and delivery of BINDER GmbH apply, which were valid at the time of purchasing the chamber.

Certified companies disassemble waste (used) BINDER equipment in primary substances for recycling according to Directive 2012/19/EU. The devices must be free from toxic, infectious or radioactive substances in order to eliminate any health hazards to the employees of the recycling companies.

	<p>Prior to handing the chamber over to a recycling company, it is the user's responsibility that it is free from toxic, infectious or radioactive substances.</p> <ul style="list-style-type: none"> • Prior to disposal, clean all introduced or residual toxic substances from the chamber. • Prior to disposal, disinfect the chamber from all sources of infection. Be aware that sources of infection may also be located outside the inner chamber. • If you cannot safely remove all toxic substances and sources of infection from the chamber, dispose of it as “special” waste according to national law. • Fill out the contamination clearance certificate (chap. 30) and enclose it with the chamber.
---	---

 	 WARNING
	<p>Danger of intoxication and infection through contamination of the chamber with toxic, infectious or radioactive substances.</p> <p>Damages to health.</p> <ul style="list-style-type: none"> Ø NEVER take a chamber contaminated with toxic substances or sources of infection for recycling according to Directive 2012/19/EU. ➤ Prior to disposal, remove all toxic substances and sources of infection from the chamber. ➤ A chamber from which all toxic substances or sources of infection cannot be safely removed must be considered as “special” waste according to national law. Dispose of it accordingly.

26.4 Disposal of the chamber in the member states of the EU except for the Federal Republic of Germany

According to Annex I of Directive 2012/19/EU of the European Parliament and of the Council on waste electrical and electronic equipment (WEEE), BINDER devices are classified as “monitoring and control instruments” (category 9) only intended for professional use“. They must not be disposed of at public collecting points.

The chambers bear the symbol for the marking of electrical and electronic equipment manufactured / placed on the market in the EC after 13 August 2005 and be disposed of in separate collection according to the Directive 2012/19/EU on waste electrical and electronic equipment (WEEE). WEEE marking: crossed-out wheeled bin with solid bar under.

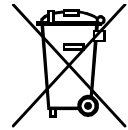



At the end of the device's service life, notify the distributor who sold you the device, who will take back and dispose of the chamber according to the Directive 2012/19/EU on waste electrical and electronic equipment (WEEE).

	NOTICE
	<p>Danger of violation against existing law if not disposed of properly.</p> <ul style="list-style-type: none"> Ø Do NOT dispose of BINDER devices at public collecting points. ➤ Have the device disposed of professionally at a recycling company that is certified according to conversion of the Directive 2012/19/EU into national law. <li style="text-align: center;"><i>or</i> ➤ Instruct the distributor who sold you the device to dispose of it. The agreements apply that were agreed with the distributor when purchasing the chamber (e.g. his general terms of payment and delivery). ➤ If your distributor is not able to take back and dispose of the chamber, please contact BINDER service.

Certified companies disassemble waste (used) BINDER equipment in primary substances for recycling according to Directive 2012/19/EU. The devices must be free from toxic, infectious or radioactive substances in order to eliminate any health hazards to the employees of the recycling companies.

	<p>Prior to handing the chamber over to a recycling company, it is the user's responsibility that it is free from toxic, infectious or radioactive substances.</p> <ul style="list-style-type: none"> • Prior to disposal, clean all introduced or residual toxic substances from the chamber. • Prior to disposal, disinfect the chamber from all sources of infection. Be aware that sources of infection may also be located outside the inner chamber. • If you cannot safely remove all sources of infection and toxic substances from the chamber, dispose of it as "special" waste according to national law. • Fill out the contamination clearance certificate (chap. 30) and enclose it with the chamber.
---	---

	<div style="background-color: #FFA500; padding: 5px; text-align: center;">  WARNING </div> <p>Danger of intoxication and infection through contamination of the chamber with toxic, infectious or radioactive substances.</p> <p>Damages to health.</p> <ul style="list-style-type: none"> Ø NEVER take a chamber contaminated with toxic substances or sources of infection for recycling according to Directive 2012/19/EU. ➤ Prior to disposal, remove all toxic substances and sources of infection from the chamber. ➤ A chamber from which all toxic substances or sources of infection cannot be safely removed must be considered as "special" waste according to national law. Dispose of it accordingly.
---	---

26.5 Disposal of the chamber in non-member states of the EU

	<div style="background-color: #00AEEF; color: white; padding: 5px; text-align: center;"> NOTICE </div> <p>Danger of violation against existing law if not disposed of properly.</p> <p>Alteration of the environment.</p> <ul style="list-style-type: none"> ➤ For final decommissioning and disposal of the vacuum drying oven, please contact BINDER Service. ➤ Follow the statutory regulations for appropriate, environmentally friendly disposal.
---	---

Chamber with MB2 controller: The main board of the vacuum drying oven includes a lithium cell. Please dispose of it according to national regulations.

27. Technical description

27.1 Factory calibration and adjustment

This chamber was calibrated and adjusted in the factory. Calibration and adjustment were performed using standardized test instructions, according to the QM DIN EN ISO 9001 system applied by BINDER (certified since December 1996 by TÜV CERT). All test equipment used is subject to the administration of measurement and test equipment that is also a constituent part of the BINDER QM DIN EN ISO 9001 systems. They are controlled and calibrated to a DKD-Standard at regular intervals.

Factory adjustment was done in the center of the usable volume and under vacuum conditions. the sensor is fixed in the middle of the expansion rack in a way ensuring good thermal conductivity (heat conduction). Measuring is performed in equilibrated state.

	NOTICE
	<p>Danger of invalid calibration caused by modified thermal conductivity when changing between aluminum and stainless steel racks.</p> <p>Undefined heating performance.</p> <ul style="list-style-type: none"> ⊘ Do NOT change between aluminum and stainless steel racks. ➤ Operate the chamber with the supplied expansion racks only.

27.2 Over current protection

The chambers are protected by one or two miniature fuses against over current, accessible from the outside. The miniature fuses are located at the rear of the chamber next to the power cable connection. Each fuse holder is equipped with a fuse clip 5mm x 20 mm (cUL-Version 6,3x32 mm). A fuse may be replaced only with a substitute of the same ratings. Refer to the technical data of the respective device type.

27.3 VD / VD-UL technical data

Chamber size		23	56	115
External dimensions				
Vacuum oven				
Width, net	mm / inch	523 / 20.59	638 / 25.12	743 / 29.25
Height, gross (including feet)	mm / inch	720 / 28.35	837 / 25.08	964 / 37.95
Depth, net	mm / inch	490 / 19.29	540 / 21.26	660 / 25.98
Depth, gross (including door handle, connections)	mm / inch	596 / 23.46	645 / 25.39	764 / 30.08
Window width	mm / inch	265 / 10.43	380 / 14.96	486 / 19.13
Window height	mm / inch	265 / 10.43	380 / 14.96	486 / 19.13
Pump module (option)				
Width, net	mm / inch	523 / 20.59	638 / 25.12	743 / 29.25
Height, net	mm / inch	705 / 27.76	705 / 27.76	705 / 27.76
Depth, net	mm / inch	491 / 19.33	539 / 21.22	659 / 25.94
Depth, gross (including door handle, connections)	mm / inch	546.5 / 21.52	594.5 / 23.41	714.5 / 28.13
Chamber with optional pump module				
Width, net	mm / inch	523 / 20.59	638 / 25.12	743 / 29.25
Height, net	mm / inch	1425 / 56.10	1542 / 60.71	1707 / 67.20
Depth, net	mm / inch	720 / 28.35	837 / 25.08	964 / 37.95
Depth, gross (including door handle, connections)	mm / inch	596 / 23.46	645 / 25.39	764 / 30.08

Chamber size		23	56	115	
External dimensions					
Wall clearances					
Wall clearance, rear (minimum)	mm / inch	100 / 3.94	100 / 3.94	100 / 3.94	
Wall clearance, side (minimum)	mm / inch	70 / 2.76	70 / 2.76	70 / 2.76	
Internal dimensions					
Width	mm / inch	285 /	400 / 15.75	506 / 19.92	
Height	mm / inch	285 /	400 / 15.75	506 / 19.92	
Depth	mm / inch	295 /	343 /	460 / 18.11	
Interior volume	l / cu.ft.	24 /	55 /	119 /	
Racks					
Number of expansion racks (aluminum), series		1	1	1	
Number of expansion racks (aluminum), max.		4	5	6	
Permissible load per rack	Kg / lbs	20 / 44	20 / 44	20 / 44	
Permissible total load	Kg / lbs	50 /	60 /	70 /	
Weight					
Weight (empty)	Kg / lbs	64 / 141	96 / 212	146 / 322	
Temperature data					
Temperature range	degrees above room temperature	°C / °F	9 / 16.2	9 / 16.2	9 / 16.2
	up to	°C / °F	220 / 428	220 / 428	220 / 428
Temperature fluctuation	at 100 °C / 212 °F	± K	0.1	0.1	0.1
	at 220 °C / 428 °F	± K	0.1	0.1	0.1
Temperature uniformity (variation)	at 100 °C / 212 °F	± K	1.0	1.5	2.9
	at 220 °C / 428 °F	± K	2.5	5.5	7.5
Heating up time	to 100 °C / 212 °F	min	80	80	130
	to 220 °C / 428 °F	min	150	160	260
Vacuum data					
Vacuum connection with small flange	DN mm / inch	16 / 0.63	16 / 0.63	16 / 0.63	
Measuring access port with small flange	DN mm / inch	16 / 0.63	16 / 0.63	16 / 0.63	
Inert gas connection with flow-limiter	Ø mm / inch	3 / 0.12	3 / 0.12	3 / 0.12	
Adapter with hose olive		8 / 0.31	8 / 0.31	8 / 0.31	
Vacuum range (adjustable)	mbar	10 to 1100	10 to 1100	10 to 1100	
End vacuum	mbar / inHg	1x10 ⁻² / 0.0003	1x10 ⁻² / 0.0003	1x10 ⁻² / 0.0003	
Leak rate	bar/h / inHg/h	1x10 ⁻² / 0.295	1x10 ⁻² / 0.295	1x10 ⁻² / 0.295	
Electrical data (model versions VD023-230V, VD056-230V, VD115-230V)					
IP protection type according to EN 60529	IP	20	20	20	
Nominal voltage (+/-10%)	at 50 Hz power frequency	V	200-230	200-230	200-230
	at 60 Hz power frequency	V	200-230	200-230	200-230
Current type		1N~	1N~	1N~	
Nominal power	kW	0,90	1,40	1,60	
Nominal current	A	3,9	6,1	7,0	
Chamber fuse 5 x 20 mm / 250V / time-lag T	Amp	2 x 6,3	2 x 8	2 x 10	
Power plug		grounded plug			
Power plug of pump module (option)		grounded plug			
Over-voltage category acc. to IEC 61010-1		II	II	II	
Pollution degree acc. to IEC 61010-1		2	2	2	

Chamber size			23	56	115
Different electrical data for VD-UL constructed for the USA and Canada (model versions VD023UL-120V, VD056UL-120V, VD115UL-120V)					
Nominal voltage (+/-10%)	at 50 Hz power frequency	V	100-120	100-120	100-120
	at 60 Hz power frequency	V	100-120	100-120	100-120
Nominal current		A	7,5	11,7	13,4
Chamber fuse 5 x 20 mm / 250V / time-lag T		A	10	2 x 16	--
Chamber fuse 6.3 x 32 mm / 250V / time-lag T		A	--	--	2 x 20
Power plug		NEMA	5-15P	5-20P	5-20P
Power plug of pump module (option)		NEMA	5-15P	5-15P	5-15P
Environment-specific data					
Noise level VD (mean value)		dB (A)	40	40	40
Energy consumption	at 100 °C / 212 °F	Wh/h	140	180	230
	at 220 °C / 428 °F	Wh/h	370	560	750

All technical data is specified for unloaded chambers with standard equipment (with aluminum racks) at an ambient temperature of +22 °C +/- 3 °C / 71.6 °F +/- 5.4 °F and a power supply voltage fluctuation of +/- 10 %. Technical data is determined in accordance to BINDER Factory Standard Part 2:2015 and DIN 12880:2007.

All indications are average values, typical for chambers produced in series. We reserve the right to change technical specifications at any time.

27.4 Equipment and options (extract)

	To operate the chamber, use only original BINDER accessories or accessories / components from third-party suppliers authorized by BINDER. The user is responsible for any risk arising from using unauthorized accessories.
---	---

Regular equipment
RD4 microprocessor program controller with LED display
Ethernet interface for computer communication
USB interface
Safety controller (safety device class 2 according to DIN 12880:2007)
Inert gas connection / ambient air inlet "GAS/AIR", adapter with hose olive 8 mm, with fine-dosing valve for aeration / inert gas
Measuring connection (DN 16), rear
Safety glass panel

Options / accessories
Expansion racks, aluminum or stainless steel 1.4571
Microprocessor program controller MB2 with touchscreen
Lockable door
Interior LED light
Analog outputs 4-20mA for temperature and pressure
Additional inert gas connection / ambient air inlet "GAS/AIR 2", adapter with hose olive 8 mm, with fine-dosing valve for aeration / inert gas
Additional universal access port 40 mm / 1.57 in
FKM door gasket (temperature resistant up to 150 °C / 302 °F)
Object temperature display with flexible Pt 100 temperature sensor

Options / accessories
APT-COM™ 4 Multi Management Software for logging and display of temperature data and networking up to 100 chambers with PC
Connection kit for vacuum pump with various small flange parts
Measuring access port, vacuum, 9 poles (DN 16)
Pump module
Pump stand VAP 1 with separator and emission condenser, ready for connection
Pump stand VAP 2 with separator and emission condenser, ready for connection
Factory calibration certificate
Extension to factory calibration certificate (additional value)
Factory calibration certificate for object temperature display
Factory calibration certificate for pressure display
Extension to factory calibration certificate for pressure display (additional pressure)
Qualification folder
Evaporating dish with rim, small or large
Stable table on wheels with castors and locking brakes

27.5 Accessories and spare parts (extract)

	BINDER GmbH is responsible for the safety features of the chamber only, provided skilled electricians or qualified personnel authorized by BINDER perform all maintenance and repair, and if components relating to chamber safety are replaced in the event of failure with original spare parts. The user is responsible for any risks arising from using unauthorized accessories/components.
--	--

Chamber size	23	56	115
Description	Art. No.		
Expansion rack, aluminum	8009-1031	8009-1030	8009-1029
Expansion rack, stainless steel	8009-1093	8009-1092	8009-1091
Exchange of aluminum expansion racks for stainless steel, calibration included	8012-1957	8012-1956	8012-1955
Silicon door gasket, temperature-resistant up to 200 °C / 392°F	6005-0290	6005-0291	6005-0292
FKM door gasket, temperature-resistant up to 150 °C / 302 °F, acid-resistant, silicon free	8012-0500	8012-0501	8012-0502
Pump module with power socket 230 V	8012-1942	8012-1943	8012-1944
Pump module with power socket 115 V	8012-1945	8012-1946	8012-1947
Chamber fuse 5 x 20 mm / 250V / time lag T for VD 230 V	5006-0092	5006-0093	5006-0079
Chamber fuse 5 x 20 mm / 250V / time lag T for VD 23-UL, VD 56-UL	5006-0079	5006-0103	---
Chamber fuse 6,3 x 32 mm / 250V / time lag T for VD 115-UL	---	---	5006-0030
Safety glass panel	6012-0012	6012-0013	6012-0014
Rack holder	6004-0230	6004-0229	6004-0211

Chamber size	23	56	115
Description	Art. No.		
Pump module (230 V)	8012-1942	8012-1943	8012-1944
Pump module (120 V)	8012-1945	8012-1946	8012-1947
Pump module VD (230V) with VAP 1 pump	8012-1958	8012-1959	8012-1960
Pump module VD (120V) with VAP 1 pump	8012-1961	8012-1962	8012-1963
Pump module VD (230V) with VAP 2 pump	8012-1964	8012-1965	8012-1966
Pump module VD (120V) with VAP 2 pump	8012-1967	8012-1968	8012-1969

Description	Art. No.
Accessory kit, consisting of:	8009-0070
Copper seal ring	6005-0056
Hose olive	6009-0064
Universal centering ring	6009-0048
Straining ring	6009-0009
Blind flange	6009-0010
Door handle, complete	6002-0541
Stable table on wheels with castors and locking brakes	9051-0018
Evaporating dish, small	4022-0125
Evaporating dish, large	4022-0126
Pump stand VAP 1 (230V)	5013-0217
Pump stand VAP 1 (120V)	5013-0223
Pump stand VAP 2 (230V)	5013-0218
Pump stand VAP 2 (120V)	5013-0219
VD connection kit for VAP 1 / VAP 2 vacuum pump	8012-1995
Neutral cleaning agent, 1 kg	1002-0016

Validation service	Art. No.
Qualification folder IQ-OQ (printed version)	7007-0001
Qualification folder IQ-OQ (digital version)	7057-0001
Qualification folder IQ-OQ-PQ (printed version)	7007-0005
Qualification folder IQ-OQ-PQ (digital version)	7057-0005
Execution of IQ-OQ	DL420300
Execution of IQ-OQ-PQ	DL440500

Calibration service	Art. No.
Calibration of temperature including certificate (1 measuring point)	8012-1145
Spatial temperature measurement including certificate (9 measuring points)	8012-0916
Spatial temperature measurement including certificate (15 measuring points)	8012-0919
Calibration of pressure including certificate	8012-0440

For information on components not listed here, please contact BINDER Service.

27.6 Dimensions

27.6.1 VD 23

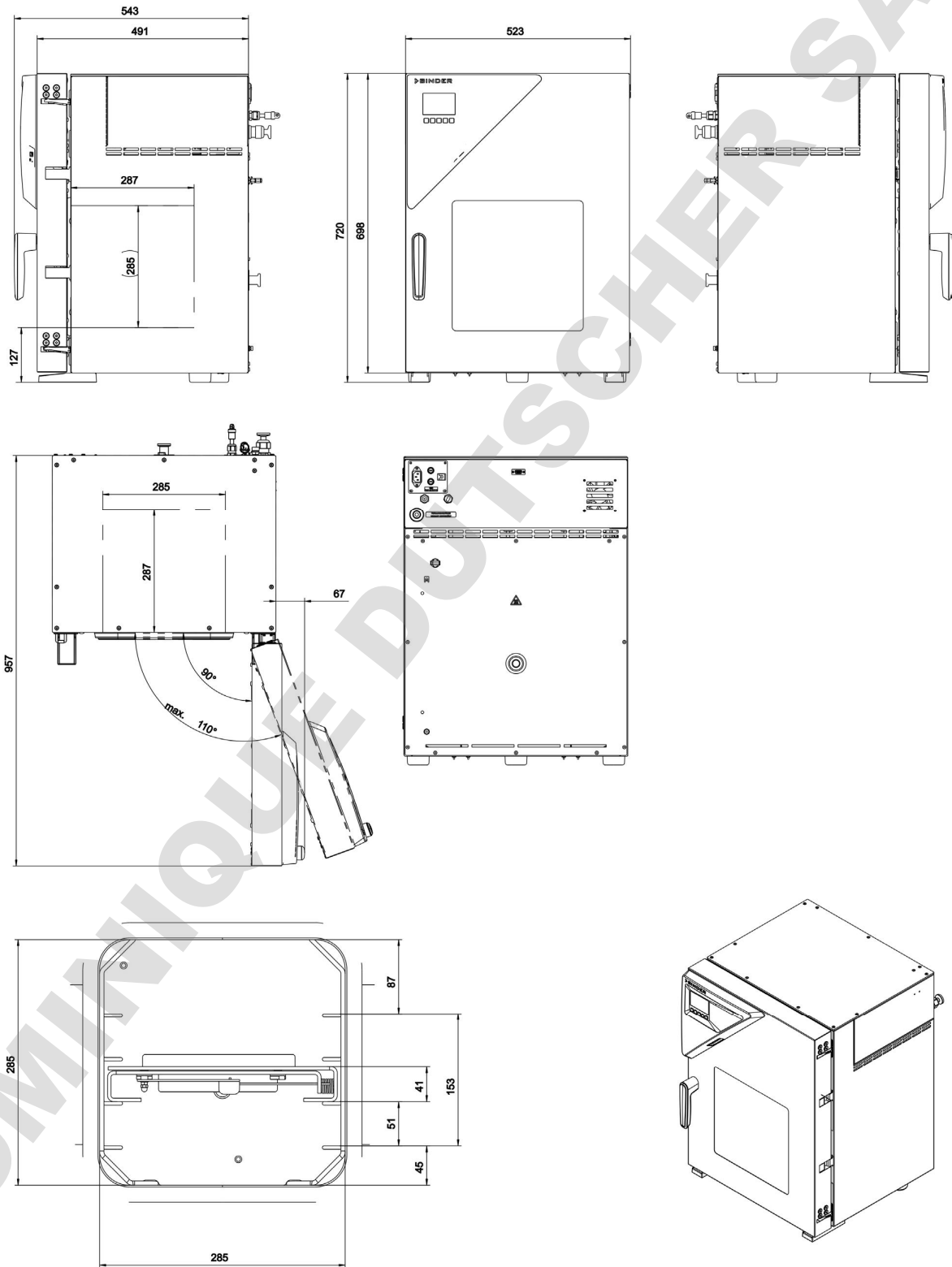

[Dimensions in mm]

27.6.2 VD 56

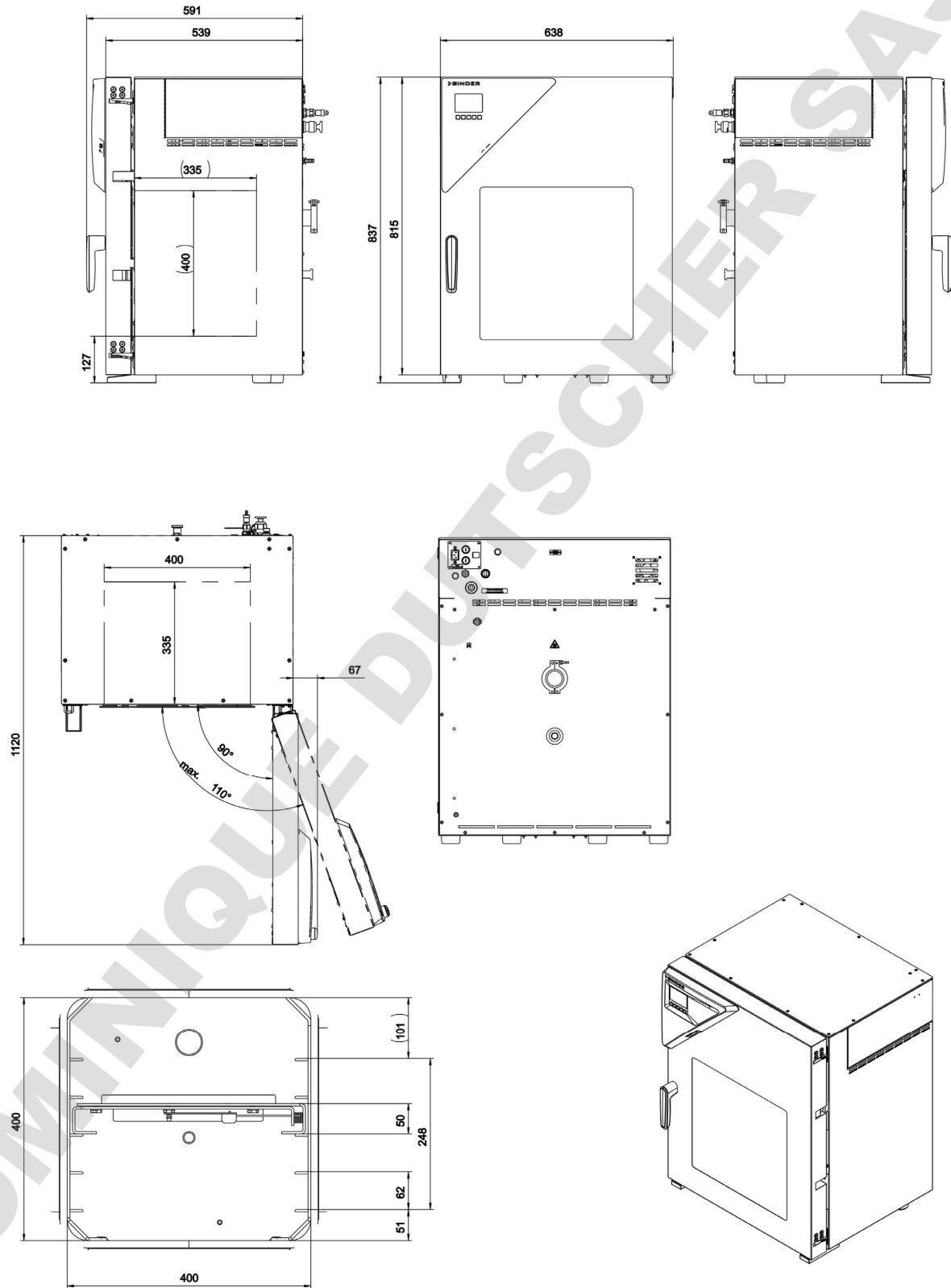

[Dimensions in mm]

27.6.3 VD 115

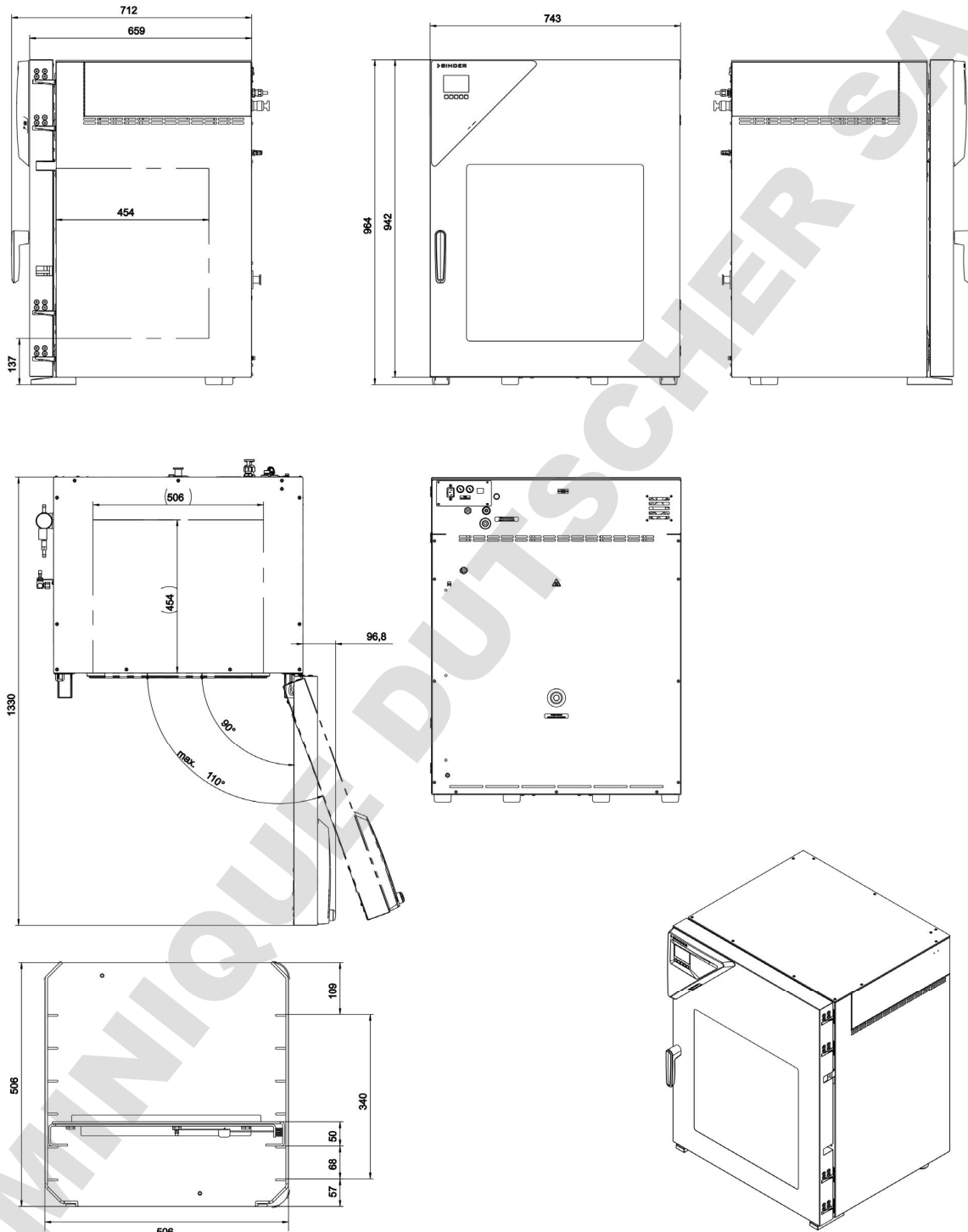

[Dimensions in mm]

28. Certificates and declarations of conformity

28.1 EU Declaration of Conformity



Best conditions for your success

	EU-Konformitätserklärung / EU Declaration of Conformity / Déclaration de conformité UE / Declaración de conformidad UE / Dichiarazione di conformità UE / Декларация соответствия EU
Hersteller / Manufacturer / Fabricant / Fabricante / Fabbri- cante / Производитель	BINDER GmbH
Anschrift / Address / Adresse / Dirección / Indirizzo / Адрес	Im Mittleren Ösch 5, 78532 Tuttlingen, Germany
Produkt / Product / Produit / Producto / Prodotto / Продукт	Vakuumentrockenschränke Vacuum drying ovens Etuves de séchage à vide Estufas de secado al vacío Stufe a vuoto Вакуумные сушильные шкафы ей
Typenbezeichnung / Type / Type / Tipo / Tipo / Тип	VD 23, VD 56, VD 115 (E3.1)
Art. No. / Art. no. / Réf. / Art. N° / Art. n. / № арт.	9630-0001, 9630-0002, 9630-0003, 9630-0005, 9630-0006, 9630-0007

Die oben beschriebenen Maschinen sind konform mit folgenden EG/EU-Richtlinien (gemäß Veröffentlichung im Amtsblatt der europäischen Kommission):
 The machines described above are in conformity with the following EC/EU Directives (as published in the Official Journal of the European Union):
 Les machines décrites ci-dessus sont conformes aux directives CE/UE suivantes (selon leur publication dans le Journal officiel de l'Union européenne):
 La máquina descrita arriba cumple con las siguientes directivas de la CE/UE (publicados en el Diario oficial de la Unión Europea):
 Le macchine sopra descritte sono conforme alle seguenti direttive CE/UE (secondo la pubblicazione nella Gazzetta ufficiale della Commissione europea):
 Машина, указанная выше, полностью соответствует следующим регламентам ЕС/ЕУ (опубликованным в Официальном журнале Европейского Содружества):

<ul style="list-style-type: none"> • 2006/42/EC Maschinenrichtlinie 2006/42/EG / Machinery directive 2006/42/EC / Directive Machines 2006/42/EC / Directiva 2006/42/CE (Máquinas) / Direttiva macchine 2006/42/CE / Директива о машинах 2006/42/EC • 2014/30/EU EMV-Richtlinie 2014/30/EU / EMC Directive 2014/30/EU / Directive CEM 2014/30/UE / Directiva CEM 2014/30/UE / Direttiva EMC 2014/30/UE / Директива ЭМС 2014/30/EU • 2011/65/EU RoHS-Richtlinie 2011/65/EU / RoHS Directive 2011/65/EU / Directive RoHS 2011/65/UE / Directiva RoHS 2011/65/UE / Direttiva RoHS 2011/65/UE / Директива RoHS 2011/65/EU

1 / 3

BINDER GmbH Postfach 102 D-78502 Tuttlingen **Anschrift:** BINDER GmbH Im Mittleren Ösch 5 D-78532 Tuttlingen
Kontakt: Telefon: +49 (0) 74 62 / 20 05 - 0 | Telefax: +49 (0) 74 62 / 20 05 - 100 | info@binder-world.com | www.binder-world.com
Geschäftsführung: Dipl.-Ing. Peter M. Binder | Amtsgericht Stuttgart, HRB 727150 | Sitz der Gesellschaft: Tuttlingen
Bankverbindung: Kreissparkasse Tuttlingen Konto-Nr.: 2266 BLZ: 643 500 70 | IBAN-Code: DE05643 500700 000002266 | SWIFT-Code: SOLA DE S1TUT
 \$-Account 2202 611 55 | IBAN-Code: DE7464350070 0220 261155 | SWIFT-Code: SOLA DE S1TUT
 Deutsche Bank Tuttlingen Konto-Nr.: 2 138 709 BLZ: 653 700 75 | IBAN-Code: DE56653 70075 0213870900 | SWIFT-Code: DEUT DE SS603
 Altgeräte-Entsorgung gemäß WEEE-Reg.-Nr. DE 37004963



Die oben beschriebenen Maschinen entsprechen aufgrund ihrer Konzipierung und Bauart sowie in der von uns in Verkehr gebrachten Ausführung den einschlägigen grundlegenden Sicherheits- und Gesundheitsanforderungen der genannten EG/EU-Richtlinien.

The machines described above are conform to the mentioned EC/EU directives in regard to the relevant safety and health demands due to their conception and style of construction as well as to the version put onto market by us.

Les machines décrites ci-dessus correspondent aux demandes de sécurité et de santé des directives citées de la CE/UE due à leur conception et construction et dans la réalisation mise sur le marché par nous.

Las máquinas descritas arriba se corresponden con los requisitos básicos pertinentes de seguridad y salud de las citadas directivas de la CE/UE debido a su concepción y fabricación, así como a la realización llevada a cabo por nosotros.

Le macchine sopra descritte sono conforme ai requisiti essenziali di sanità e sicurezza pertinenti delle summenzionate direttive CE/UE in termini di progettazione, tipo di costruzione ed esecuzione messa da noi in circolazione.

Машины описано выше, соответствует указанным директивам ЕС/ЕУ в отношении требований соответствующей безопасности и здоровья по концепции и конструкции так же как и версия, применяемая нами на рынке.

Die oben beschriebenen Maschinen tragen entsprechend die Kennzeichnung CE.

The machines described above, corresponding to this, bear the CE-mark.

Les machines décrits ci-dessus, en correspondance, portent l'indication CE.

Las máquinas descritas arriba, en conformidad, llevan la indicación CE.

Le macchine sopra descritte sono contrassegnate dal marchio CE.

Машины описано выше, в соответствии с изложенным выше маркированы знаком CE.

Die oben beschriebenen Maschinen sind konform mit folgenden harmonisierten Normen:

The machines described above are in conformity with the following harmonized standards:

Les machines décrits ci-dessus sont conformes aux normes harmonisées suivantes:

Las máquinas descritas arriba cumplen con las siguientes normas:

Le macchine sopra descritte sono conforme alle seguenti normative armonizzate:

Машины описано выше, полностью соответствуют следующим стандартам:

Sicherheit / Safety / Sécurité / Seguridad / Sicurezza / Нормативы по безопасности
<ul style="list-style-type: none"> • EN ISO 12100:2010 • EN ISO 13732-1:2008 • EN 60204-1:2018
EMV / EMC / CEM / CEM / EMC / ЭМС
<ul style="list-style-type: none"> • EN 61326-1:2013
RoHS
<ul style="list-style-type: none"> • EN 50581:2012

2 / 3

BINDER GmbH Postfach 102 D-78502 Tuttlingen **Anschrift:** BINDER GmbH Im Mittleren Ösch 5 D-78532 Tuttlingen
Kontakt: Telefon: +49 (0) 74 62 / 20 05 - 0 | Telefax: +49 (0) 74 62 / 20 05 - 100 | info@binder-world.com | www.binder-world.com
Geschäftsführung: Dipl.-Ing. Peter M. Binder | Amtsgericht Stuttgart, HRB 727150 | Sitz der Gesellschaft: Tuttlingen
Bankverbindung: Kreissparkasse Tuttlingen Konto-Nr.: 2266 BLZ: 643 500 70 | IBAN-Code: DE05643 500700 00002266 | SWIFT-Code: SOLA DE S1TUT
S-Account 2202 611 55 | IBAN-Code: DE7464350070 0220 261155 | SWIFT-Code: SOLA DE S1TUT
Deutsche Bank Tuttlingen Konto-Nr.: 2 138 709 BLZ: 653 700 75 | IBAN-Code: DE56653 70075 0213870900 | SWIFT-Code: DEUT DE SS603
 Altgeräte-Entsorgung gemäß WEEE-Reg.-Nr. DE 37004983

78532 Tuttlingen, 25.03.2020
BINDER GmbH



P. M. Binder
Geschäftsführender Gesellschafter
Managing Director
Directeur général
Director general
Direttore Generale
Генеральный Директор



J. Bollaender
Leiter F & E
Director R & D
Chef de service R&D
Responsable I & D
Direttore R & D
Глава департамента R&D

3 / 3

BINDER GmbH Postfach 102 D-78502 Tuttlingen **Anschrift:** BINDER GmbH Im Mittleren Ösch 5 D-78532 Tuttlingen
Kontakt: Telefon: +49 (0) 74 62 / 20 05 - 0 | Telefax: +49 (0) 74 62 / 20 05 - 100 | info@binder-world.com | www.binder-world.com
Geschäftsführung: Dipl.-Ing. Peter M. Binder | Amtsgericht Stuttgart, HRB 727150 | Sitz der Gesellschaft: Tuttlingen
Bankverbindung: Kreissparkasse Tuttlingen Konto-Nr.: 2266 BLZ: 643 500 70 | IBAN-Code: DE05643 500700 00002266 | SWIFT-Code: SOLA DE S1TUT
S-Account 2202 611 55 | IBAN-Code: DE7464350070 0220 261155 | SWIFT-Code: SOLA DE S1TUT
Deutsche Bank Tuttlingen Konto-Nr.: 2 138 709 BLZ: 653 700 75 | IBAN-Code: DE56653 70075 0213870900 | SWIFT-Code: DEUT DE SS603
Altgeräte-Entsorgung gemäß WEEE-Reg.-Nr. DE 37004983

29. Product registration

Online Product Registration
Register your BINDER now!

www.binder-world.com/register

The registration is free and takes just a few seconds

Advantages:

- ▶ Short response times if service is needed
- ▶ Fair prices when relocating or installing equipment
- ▶ Calibration as required at no charge in case of recalls
- ▶ Free information on news, product upgrades and accessories

Easy registered in 3 steps:



1. List serial number here:

-

2. Go online: www.binder-world.com/register

3. Register serial number

30. Contamination clearance certificate

30.1 For chambers located outside USA and Canada

Declaration regarding safety and health

Erklärung zur Sicherheit und gesundheitlichen Unbedenklichkeit

The German Ordinance on Hazardous Substances (GefStoffV), and the regulations regarding safety at the workplace, require that this form be filled out for all products that are returned to us, so that the safety and the health of our employees can be guaranteed.

Die Sicherheit und Gesundheit unserer Mitarbeiter, die Gefahrstoffverordnung GefStoffV und die Vorschriften zur Sicherheit am Arbeitsplatz machen es erforderlich, dass dieses Formblatt für alle Produkte, die an uns zurückgeschickt wird.

	<p>Note: A repair is not possible without a completely filled out form. Ohne Vorliegen des vollständig ausgefüllten Formblattes ist eine Reparatur nicht möglich.</p>
---	---

- A completely filled out form must be transmitted via Fax (+49 (0) 7462 2005 93555) or by letter in advance, so that this information is available before the equipment/component part arrives. A second copy of this form must accompany the equipment/component part. In addition, the carrier should be notified.

Eine vollständig ausgefüllte Kopie dieses Formblattes soll per Telefax (Nr. +49 (0) 7462 2005 93555) oder Brief vorab an uns gesandt werden, so dass die Information vorliegt, bevor das Gerät/Bauteil eintrifft. Eine weitere Kopie soll dem Gerät/Bauteil beigelegt sein. Ggf. ist auch die Spedition zu informieren.

- Incomplete information or non-conformity with this procedure will inevitably lead to substantial delays in processing. Please understand the reason for this measure, which lies outside our area of influence, and will help us to speed up this procedure.

Unvollständige Angaben oder Nichteinhalten dieses Ablaufs führen zwangsläufig zu beträchtlichen Verzögerungen in der Abwicklung. Bitte haben Sie Verständnis für Maßnahmen, die außerhalb unserer Einflussmöglichkeiten liegen und helfen Sie mit, den Ablauf beschleunigen.

- **Please print and fill out this form completely.**

Bitte unbedingt vollständig ausfüllen!

1.	Unit/ component part / type: / Gerät / Bauteil / Typ:
2.	Serial No. / Serien-Nr.:
3.	Details about utilized substances / biological substances / Einzelheiten über die eingesetzten Substanzen/biologische Materialien:
3.1	Designations / Bezeichnungen:
a)	_____
b)	_____
c)	_____
3.2	Safety measures required for handling these substances / Vorsichtsmaßnahmen beim Umgang mit diesen Stoffen:
a)	_____
b)	_____
c)	_____

3.3	Measures to be taken in case of skin contact or release into the atmosphere / Maßnahmen bei Personenkontakt oder Freisetzung: a) _____ b) _____ c) _____ d) _____
3.4	Other important information that must be taken into account / Weitere zu beachtende und wichtige Informationen: a) _____ b) _____ c) _____
4.	Declaration on the risk of these substances (please checkmark the applicable items) / Erklärung zur Gefährlichkeit der Stoffe (bitte Zutreffendes ankreuzen) :
	<input type="checkbox"/> 4.1 For non toxic, non radioactive, biologically harmless materials / für nicht giftige, nicht radioaktive, biologisch ungefährliche Stoffe: We hereby guarantee that the above-mentioned unit / component part... / Wir versichern, dass o.g. Gerät/Bauteil... <input type="checkbox"/> Has not been exposed to or contains any toxic or otherwise hazardous substances / weder giftige noch sonstige gefährliche Stoffe enthält oder solche anhaften. <input type="checkbox"/> That eventually generated reaction products are non-toxic and also do not represent a hazard / auch evtl. entstandene Reaktionsprodukte weder giftig sind noch sonst eine Gefährdung darstellen. <input type="checkbox"/> Eventual residues of hazardous substances have been removed / evtl. Rückstände von Gefahrstoffen entfernt wurden.
	<input type="checkbox"/> 4.2 For toxic, radioactive, biologically harmful or hazardous substances, or any other hazardous materials / für giftige, radioaktive, biologisch bedenkliche bzw. gefährliche Stoffe oder anderweitig gefährliche Stoffe. We hereby guarantee that ... / Wir versichern, dass ... <input type="checkbox"/> The hazardous substances, which have come into contact with the above-mentioned equipment/component part, have been completely listed under item 3.1 and that all information in this regard is complete / die gefährlichen Stoffe, die mit dem o.g. Gerät/Bauteil in Kontakt kamen, in 3.1 aufgelistet sind und alle Angaben vollständig sind. <input type="checkbox"/> That the unit /component part has not been in contact with radioactivity / das Gerät/Bauteil nicht mit Radioaktivität in Berührung kam
5.	Kind of transport / transporter / Transportweg/Spediteur: Transport by (means and name of transport company, etc.) Versendung durch (Name Spediteur o.ä.) _____ Date of dispatch to BINDER GmbH / Tag der Absendung an BINDER GmbH: _____

We hereby declare that the following measures have been taken / Wir erklären, dass folgende Maßnahmen getroffen wurden:

- Hazardous substances were removed from the unit including component parts, so that no hazard exists for any person in the handling or repair of these items / das Gerät/Bauteil wurde von Gefahrstoffen befreit, so dass bei Handhabung/Reparaturen für die betreffenden Person keinerlei Gefährdung besteht
- The unit was securely packaged and properly identified / das Gerät wurde sicher verpackt und vollständig gekennzeichnet.
- Information about the hazardousness of the shipment (if required) has been provided to the transporter / der Spediteur wurde (falls vorgeschrieben) über die Gefährlichkeit der Sendung informiert.

We hereby commit ourselves and guarantee that we will indemnify BINDER GmbH for all damages that are a consequence of incomplete or incorrect information provided by us, and that we will exempt BINDER GmbH from eventual damage claims by third parties./ Wir versichern, dass wir gegenüber BINDER für jeden Schaden, der durch unvollständige und unrichtige Angaben entsteht, haften und BINDER gegen eventuell entstehende Schadensansprüche Dritter freistellen.

We are aware that, in accordance with Article 823 of the German Civil Code (BGB), we are directly liable with regard to third parties, in this instance especially the employees of BINDER GmbH, who have been entrusted with the handling / repair of the unit / component. / Es ist uns bekannt, dass wir gegenüber Dritten – hier insbesondere mit der Handhabung/Reparatur des Geräts/des Bauteils betraute Mitarbeiter der Firma BINDER - gemäß §823 BGB direkt haften

Name: _____

Position/Title: _____

Date / Datum: _____

Signature / Unterschrift: _____

Company stamp / Firmenstempel:



Equipment that is returned to the factory for repair must be accompanied by a completely filled out contamination clearance certificate. For service and maintenance on site, such a contamination clearance certificate must be submitted to the service technician before the start of any work. No repair or maintenance of the equipment is possible, without a properly filled out contamination clearance certificate.

30.2 For chambers located in USA and Canada

Product Return Authorization Request

Please complete this form and the Customer Decontamination Declaration (next 2 pages) and attach the required pictures. E-mail to: IDL_SalesOrderProcessing_USA@binder-world.com

After we have received and reviewed the complete information we will decide on the issue of a RMA number. Please be aware that size specifications, voltage specifications as well as performance specifications are available on the internet at www.binder-world.us at any time.

Take notice of shipping laws and regulations.

	Please fill:	
Reason for return request	<input type="radio"/> Duplicate order	
	<input type="radio"/> Duplicate shipment	
	<input type="radio"/> Demo	<i>Page one completed by sales</i>
	<input type="radio"/> Power Plug / Voltage	115V / 230 V / 208 V / 240V
	<input type="radio"/> Size does not fit space	
	<input type="radio"/> Transport Damage	Shock watch tripped? (<i>pictures</i>)
	<input type="radio"/> Other (specify below)	

Is there a replacement PO?	<input type="radio"/> Yes <input type="radio"/> No	
<i>If yes -> PO #</i>		
<i>If yes -> Date PO placed</i>		
Purchase order number		
BINDER model number		
BINDER serial number		
Date unit was received		
Was the unit unboxed?	<input type="radio"/> Yes <input type="radio"/> No	
Was the unit plugged in?	<input type="radio"/> Yes <input type="radio"/> No	
Was the unit in operation?	<input type="radio"/> Yes <input type="radio"/> No	
<i>Pictures of unit attached?</i>	<input type="radio"/> Yes <input type="radio"/> No	Pictures have to be attached!
<i>Pictures of Packaging attached?</i>	<input type="radio"/> Yes <input type="radio"/> No	

	Customer Contact Information	Distributor Contact Information
Name		
Company		
Address		
Phone		
E-mail		

Customer (End User) Decontamination Declaration

Health and Hazard Safety declaration

To protect the health of our employees and the safety at the workplace, we require that this form is completed by the user for all products and parts that are returned to us. (Distributors or Service Organizations cannot sign this form)

	NO RMA number will be issued without a completed form. Products or parts returned to our NY warehouse without a RMA number will be refused at the dock.
---	---

A second copy of the completed form must be attached to the outside of the shipping box.

1.	Unit/ component part / type:
2.	Serial No.
3.	List any exposure to hazardous liquids, gasses or substances and radioactive material
3.1	List with MSDS sheets attached where available or needed (if there is not enough space available below, please attach a page):
a)	_____
b)	_____
c)	_____
3.2	Safety measures required for handling the list under 3.1
a)	_____
b)	_____
c)	_____
3.3	Measures to be taken in case of skin contact or release into the atmosphere:
a)	_____
b)	_____
c)	_____
d)	_____
3.4	Other important information that must be considered:
a)	_____
b)	_____
c)	_____

<p>4. Declaration of Decontamination</p> <p>For toxic, radioactive, biologically and chemically harmful or hazardous substances, or any other hazardous materials.</p> <p>We hereby guarantee that</p> <p>4.1 Any hazardous substances, which have come into contact with the above-mentioned equipment / component part, have been completely listed under item 3.1 and that all information in this regard is complete.</p> <p>4.2 That the unit /component part has not been in contact with radioactivity</p> <p>4.3 Any Hazardous substances were removed from the unit / component part, so that no hazard exists for a persons in the shipping, handling or repair of these returned unit</p> <p>4.4 The unit was securely packaged in the original undamaged packaging and properly identified on the outside of the packaging material with the unit designation, the RMA number and a copy of this declaration.</p> <p>4.5 Shipping laws and regulations have not been violated.</p> <p>I hereby commit and guarantee that we will indemnify BINDER Inc. for all damages that are a consequence of incomplete or incorrect information provided by us, and that we will indemnify and hold harmless BINDER Inc. from eventual damage claims by third parties.</p>	
Name:	_____
Position:	_____
Company:	_____
Address:	_____
Phone #:	_____
Email:	_____
Date:	_____
Signature:	_____

	<p>Equipment returned to the NY warehouse for repair must be accompanied by a completed customer decontamination declaration. For service and maintenance works on site, such a customer decontamination declaration must be submitted to the service technician before the start of work. No repair or maintenance of the equipment is possible without a completed form.</p>
---	--