

Constant climate chambers



Always the right climate

KBF | KBF-S | KBF P | KBF LQC | KMF series



PRODUCT SELECTION CONSTANT CLIMATE CHAMBERS

Features	KBF › Page 6	KBF-S › Page 19	KBF P › Page 9	KBF LQC › Page 12	KMF › Page 15
Model					
Model 115	•	•	–	–	•
Model 240	•	•	•	•	•
Model 720	•	•	•	•	•
Model 1020	•	•	–	–	–
General data					
Temperature range [°C]	0...70	10...70	–	–	-10...100
Temperature range without illumination cassettes [°C]	–	–	0...70	0...70	–
Temperature range with 100% illumination [°C]	–	–	10...60	10...60	–
Humidity range [% RH]	10...80	20...80	10...80	10...80	10...98
Ethernet interface	•	•	•	•	•
USB interface	•	•	•	•	•
Forced convection	•	•	•	•	•
Controller and timer functions					
Controller display	TFT touch	LCD	TFT touch	TFT touch	TFT touch
Ramp function	•	–	–	–	•
Time delayed ON	•	–	–	–	•
Programming option	•	–	•	•	•
Weekly program function	•	–	•	•	•
Adjustable fan speed	•	•	•	•	•
Real-time clock	•	–	•	•	•
Class 3.1 independent temperature safety device	•	•	•	•	•
Temperature alarm, acoustic	•	•	•	•	•
Temperature alarm, visual	•	•	•	•	•
Suitable for stability tests					
	•	•	•	•	•
ICH Q1A	•	•	•	•	•
	•	–	•	•	•
ICH Q1B Photostability testing	–	–	•	•	–
85/85-THB-test	–	–	–	–	•

• Standard equipment

Constant climate chambers

Series KBF	Page 6
Series KBF P	Page 9
Series KBF LQC	Page 12
Series KMF	Page 15
Options and Accessories	Page 18

BINDER climatic chambers stand out when testing material behaviors under constant temperature and humidity conditions. A climatic chamber of the KBF P and KBF LQC Series also offers ICH-compliant illumination for standard-compliant long-term tests. In combination with the innovative Light Quantum Control (LQC), they offer a complete reliable solution for photostability testing in one chamber.

Wide temperature and humidity ranges can be achieved with KMF Series chambers—ideal for complex stress tests at, for instance, 85 °C and 85 % RH.

PRODUCT SELECTION CONSTANT CLIMATE CHAMBERS

Features	Series KBF › Page 6	Series KBF P › Page 9	Series KBF LQC › Page 12	Series KMF › Page 15
Model				
Model 115	•	–	–	•
Model 240	•	•	•	•
Model 720	•	•	•	•
Model 1020	•	–	–	–
General data				
Temperature range [°C]	0...70	–	–	-10...100
Temperature range without illumination cassettes [°C]	–	0...70	0...70	–
Temperature range with 100% illumination [°C]	–	10...60	10...60	–
Humidity range [% RH]	10...80	10...80	10...80	10...98
Ethernet interface	•	•	•	•
USB interface	•	•	•	•
Forced convection	•	•	•	•
Controller and timer functions				
Controller display			TFT Touch	
Ramp function	•	–	–	•
Time delayed ON	•	–	–	•
Programming option	•	•	•	•
Weekly program function	•	•	•	•
Adjustable fan speed	•	•	•	•
Real-time clock	•	•	•	•
Class 3.1 independent temperature safety device	•	•	•	•
Temperature alarm, acoustic	•	•	•	•
Temperature alarm, visual	•	•	•	•

•Standard equipment

ADVANTAGES AT A GLANCE



HOMOGENEOUS TEMPERATURE DISTRIBUTION

Series KBF, KBF P, KBF LQC, KMF

BINDER APT.line™ preheating chamber technology ensures long-term operational stability even under full load.



INTUITIVE TOUCHSCREEN CONTROLLER

Series KBF, KBF P, KBF LQC, KMF

State-of-the-art controller technology with time-segment and real-time programming with internal data recording



HOMOGENEOUS LIGHT DISTRIBUTION

Series KBF P, KBF LQC

Illumination cassettes with ICH-Q1B-compliant light sources provide flexible placement for photostability tests.



FLEXIBLE WATER AND WASTE WATER MANAGEMENT AT ANY LOCATION

Series KBF, KBF P, KMF

using the connection to the domestic water supply or an optional external water supply set (Fig.).

Series KBF | with large temperature / humidity range

The BINDER KBF is the specialist for unconditionally reliable stability testing and precise maintenance of constant climate conditions. From programming to documentation, this constant climate chamber meets all critical requirements.



KBF 240 model

MAIN FEATURES

- Temperature range: 0 °C to 70 °C
- Humidity range: 10 % to 80 % RH
- APT.line™ preheating chamber technology
- Humidity regulation with capacitive humidity sensor and vapor humidification
- Intuitive touchscreen controller with time-segment and real-time programming
- Internal data logger, measured values can be read out in open format via USB
- Unit self-test for comprehensive status analysis
- Tight-sealing inner door made of safety glass (ESG)
- Avoidance of glass corrosion by special TIMELESS coating
- Inner chamber made of stainless steel

AVAILABLE SIZES

Model	Interior volume [L]	Online data sheets
KBF 115	102	› go2binder.com/en-KBF115
KBF 240	247	› go2binder.com/en-KBF240
KBF 720	700	› go2binder.com/en-KBF720
KBF 1020	1020	› go2binder.com/en-KBF1020



TIPS & TRICKS

Benefit from our many years of experience,

Tips & Tricks: › go2binder.com/en-tips-tricks

Case Studies: › go2binder.com/en-case-studies



Find all details online
go2binder.com/en-KBF

TECHNICAL DATA

Description	KBF 115	KBF 240	KBF 720	KBF 1020
Outer dimensions				
Width net [mm]	880	925	1250	1250
Height net [mm]	1050	1460	1925	1925
Depth net [mm]	650	800	890	1145
Internal Dimensions				
Width [mm]	600	650	973	976
Height [mm]	483	785	1250	1250
Depth [mm]	351	485	576	836
Measures				
Interior volume [L]	102	247	700	1020
Net weight of the unit (empty) [kg]	129	189	312	379
permitted load [kg]	100	100	150	150
Load per rack [kg]	30	30	45	45
Performance Data Temperature				
Temperature range [°C]	0...70	0...70	0...70	0...70
Temperature variation at 40 °C [± K]	0.2	0.3	0.2	0.2
Temperature fluctuation [± K]	0.1	0.1	0.1	0.5
Performance Data Climate				
Temperature range [°C]	10...70	10...70	10...70	10...70
Temperature variation at 40 °C and 75 % RH [± K]	0.2	0.3	0.2	0.2
Temperature fluctuation at 40 °C and 75 % RH [± K]	0.1	0.1	0.1	0.1
Humidity range [% RH]	10...80	10...80	10...80	10...80
Humidity fluctuation at 40 °C and 75 % RH [± % RH]	≤2	1,5	1,5	1,5
Electrical data				
Nominal power (version 230 V) [kW]	2	2.1	3.1	3.1
Nominal power (version 240 V) [kW]	2	2.1	3.1	3.1
Fixtures				
Number of shelves (std./max.)	2/5	2/9	2/15	2/15

ORDERING INFORMATION [Art. No.]

Further details: Go to www.binder-world.com > Search > Enter Article Number

Voltage	Option model	KBF 115	KBF 240	KBF 720	KBF 1020
200...230 V 1~ 50/60 Hz	Standard	9020-0320	9020-0322	9020-0324	9020-0326
200...240 V 1~ 50/60 Hz	Standard	9020-0321	9020-0323	9020-0325	9020-0327

► You will find a selection of options, accessories and services suitable for each product on page 18

EXTRACT OF FULLFILLED STANDARDS

- ICH Q1A(R2)

TEMPERATURE-HUMIDITY CHART

KBF 115, KBF 240, KBF 720, KBF 1020

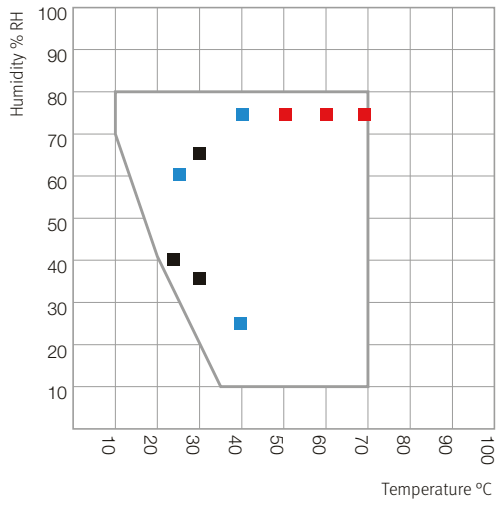

- Long term testing (ICH Q1A)
- Accelerated testing (ICH Q1A)
- Stress testing (ICH Q1A)

KBF 115, KBF 240, KBF 720, KBF 1020

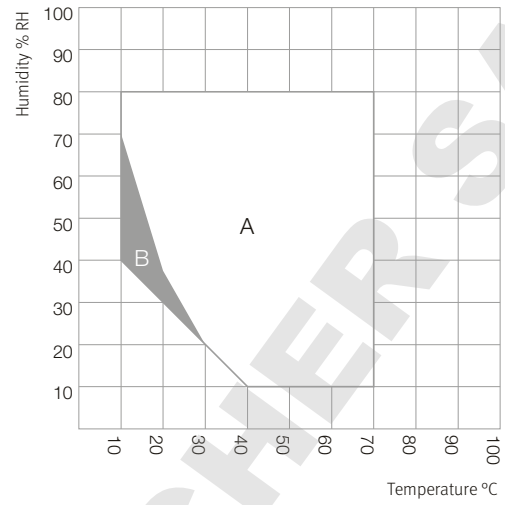

- A: Guaranteed condensation-free range
- B: Time-limited operation (max. 24 hours)

DIMENSIONS incl. fittings and connections [mm]

KBF 115

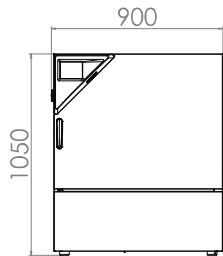

KBF 240

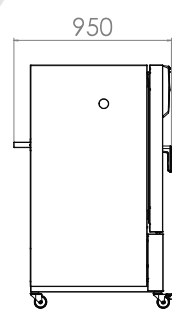
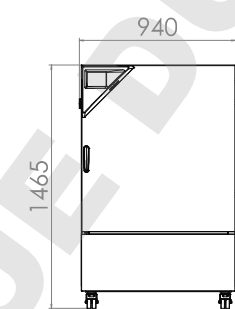
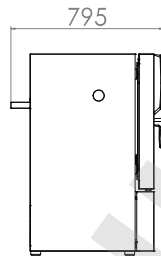

KBF 720

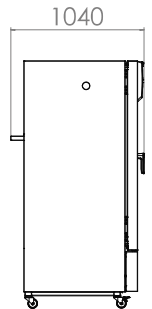
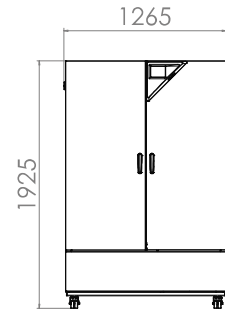

KBF 1020

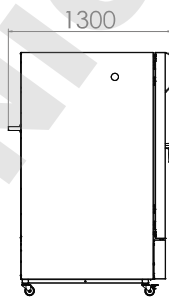
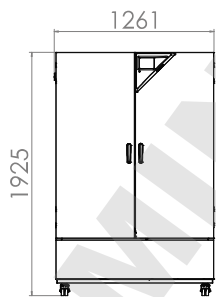

Series KBF P | with ICH-compliant light source

The KBF P constant climate chamber, equipped with ICH-compliant light source, is an expert when it comes to photostability tests and ensures clear test results in accordance with ICH Guideline Q1B. At the same time, the variable-position illumination cassettes offer homogeneous lighting conditions.



KBF P 240 model

MAIN FEATURES

- Temperature range: 0 °C to 70 °C
- Temperature range with light: 10 °C to 60 °C
- Humidity range: 10 % to 80 % RH
- positionable illumination cassettes with ICH-compliant UV/Vis light source
- APT.line™ preheating chamber technology
- Humidity regulation with capacitive humidity sensor and vapor humidification
- Inner chamber made of stainless steel
- Intuitive touchscreen controller with time-segment and real-time programming
- Internal data logger, measured values can be read out in open format via USB
- Unit self-test for comprehensive status analysis

AVAILABLE SIZES

Model	Interior volume [L]	Online data sheets
KBF P 240	247	go2binder.com/en-KBFP240
KBF P 720	700	go2binder.com/en-KBFP720



TIPS & TRICKS

Benefit from our many years of experience,

Tips & Tricks: go2binder.com/en-tips-tricks

Case Studies: go2binder.com/en-case-studies



Find all details online
go2binder.com/en-KBFP

TECHNICAL DATA

Description	KBF P 240	KBF P 720
Outer dimensions		
Width net [mm]	925	1250
Height net [mm]	1460	1925
Depth net [mm]	800	890
Internal Dimensions		
Width [mm]	650	973
Height [mm]	785	1250
Depth [mm]	485	576
Measures		
Interior volume [L]	247	700
Net weight of the unit (empty) [kg]	213	374
permitted load [kg]	100	150
Load per rack [kg]	30	45
Performance Data Temperature		
Temperature range with 100% illumination [°C]	10...60	10...60
Temperature range without illumination cassettes [°C]	0...70	0...70
Performance Data Climate		
Temperature range with 100% illumination [°C]	10...60	20...60
Temperature range without illumination cassettes [°C]	10...70	10...70
Temperature variation with illumination at 40 °C and 75 % RH [± K]	0.6	1.2
Temperature fluctuation with illumination at 40 °C and 75 % RH [± K]	0.2	0.2
Humidity range with illumination cassettes, with illumination [% RH]	10...75	10...75
Humidity range without illumination [% RH]	10...80	10...80
Humidity fluctuation with illumination at 40 °C and 75 % RH [± % RH]	2	2
Lightdata per Illumination Cassettes		
ICH compliant illumination for photo stability testing [lx]	7500	9000
ICH compliant illumination for photo stability testing [W/m²]	1.1	1.5
Electrical data		
Nominal power (version 230 V) [kW]	2.4	3.5
Nominal power (version 240 V) [kW]	2.4	3.5
Fixtures		
Number of shelves (std./max.)	2/7	3/12
Number of illumination cassettes (std./max.)	2/2	3/3

ORDERING INFORMATION [Art. No.]

Further details: Go to www.binder-world.com > Search > Enter Article Number

Voltage	Option model	KBF P 240	KBF P 720
200...230 V 1~ 50/60 Hz	Standard	9020-0328	9020-0330
200...240 V 1~ 50/60 Hz	Standard	9020-0329	9020-0331

► You will find a selection of options, accessories and services suitable for each product on page 18

EXTRACT OF FULLFILLED STANDARDS

- ICH Q1A(R2)
- ICH Q1B

TEMPERATURE-HUMIDITY CHART

KBFP 240

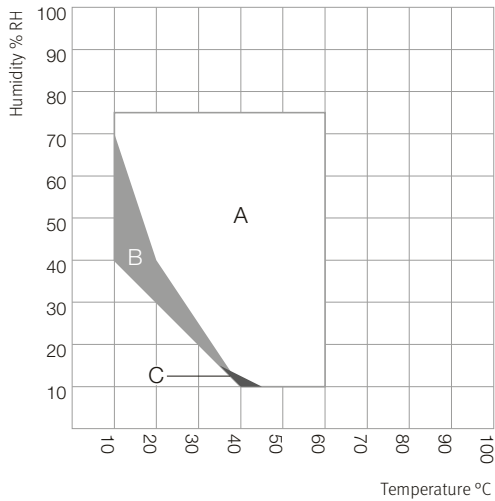

- A: Guaranteed condensation-free range
- B: Time-limited operation (max. 24 hours)
- C: Deviations of technical data may be possible

KBFP 720

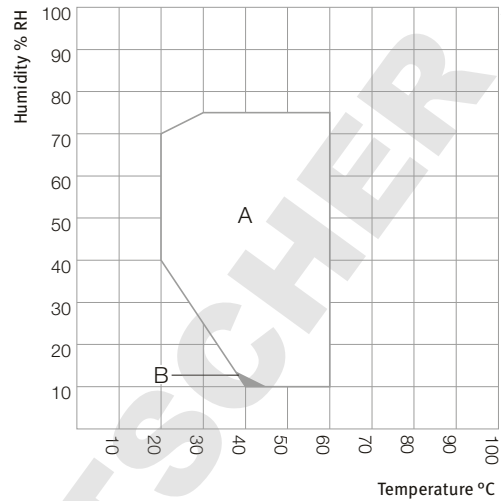

- A: Guaranteed condensation-free range
- B: Deviations of technical data may be possible

DIMENSIONS incl. fittings and connections [mm]

KBFP 240

KBFP 720

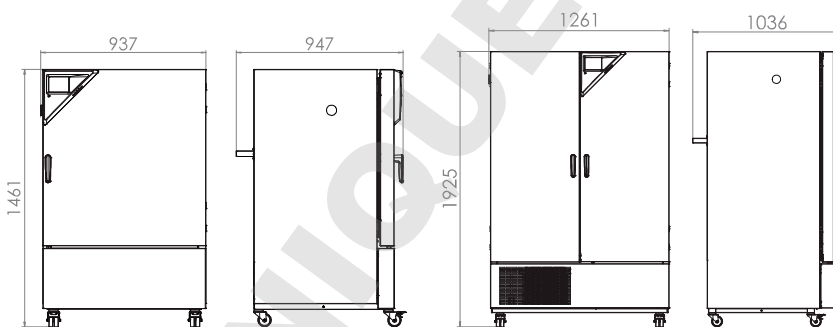

Series KBF LQC | with ICH-compliant light source and light dose control

The main advantage of the BINDER KBF LQC series is the patented light photometry for photostability tests. Two 3D spherical sensors control the light dosage of UV-A and visible light. Once the desired light dosage is achieved, the chamber switches off automatically.



KBF LQC 240 model

MAIN FEATURES

- Temperature range: 0 °C to 70 °C
- Temperature range with light: 10 °C to 60 °C
- Humidity range: 10 % to 80 % RH
- positionable illumination cassettes with ICH-compliant UV/Vis light source
- Independent light-dose control of UV-A and visible light with spherical sensors
- APT.line™ preheating chamber technology
- Humidity regulation with capacitive humidity sensor and vapor humidification
- Inner chamber made of stainless steel
- Intuitive touchscreen controller with time-segment and real-time programming
- Internal data logger, measured values can be read out in open format via USB

AVAILABLE SIZES

Model	Interior volume [L]	Online data sheets
KBF LQC 240	247	› go2binder.com/en-KBFLQC240
KBF LQC 720	700	› go2binder.com/en-KBFLQC720

i TIPS & TRICKS

Benefit from our many years of experience,

Tips & Tricks: › go2binder.com/en-tips-tricks

Case Studies: › go2binder.com/en-case-studies

Find all details online
go2binder.com/en-KBFLQC

TECHNICAL DATA

Description	KBF LQC 240	KBF LQC 720
Outer dimensions		
Width net [mm]	925	1250
Height net [mm]	1460	1925
Depth net [mm]	800	890
Internal Dimensions		
Width [mm]	650	973
Height [mm]	785	1250
Depth [mm]	485	576
Measures		
Interior volume [L]	247	700
Net weight of the unit (empty) [kg]	217	374
permitted load [kg]	100	150
Load per rack [kg]	30	45
Performance Data Temperature		
Temperature range with 100% illumination [°C]	10...60	10...60
Temperature range without illumination cassettes [°C]	0...70	0...70
Performance Data Climate		
Temperature range with 100% illumination [°C]	10...60	20...60
Temperature range without illumination cassettes [°C]	10...70	10...70
Temperature variation with illumination at 40 °C and 75 % RH [± K]	0.6	1.2
Temperature fluctuation with illumination at 40 °C and 75 % RH [± K]	0.2	0.2
Humidity range with illumination cassettes, with illumination [% RH]	10...75	10...75
Humidity range without illumination [% RH]	10...80	10...80
Humidity fluctuation with illumination at 40 °C and 75 % RH [± % RH]	2	2
Lightdata per Illumination Cassettes		
ICH compliant illumination for photo stability testing [lx]	7500	9000
ICH compliant illumination for photo stability testing [W/m²]	1.1	1.5
Electrical data		
Nominal power (version 230 V) [kW]	2.4	3.5
Nominal power (version 240 V) [kW]	2.4	3.5
Fixtures		
Number of shelves (std./max.)	2/7	3/12
Number of illumination cassettes (std./max.)	2/2	3/3

ORDERING INFORMATION [Art. No.]

Further details: Go to www.binder-world.com > Search > Enter Article Number

Voltage	Option model	KBF LQC 240	KBF LQC 720
200...230 V 1~ 50/60 Hz	Standard	9020-0332	9020-0334
200...240 V 1~ 50/60 Hz	Standard	9020-0333	9020-0335

► You will find a selection of options, accessories and services suitable for each product on page 18

EXTRACT OF FULLFILLED STANDARDS

- ICH Q1A(R2)
- ICH Q1B

TEMPERATURE-HUMIDITY CHART

KBF LQC 240

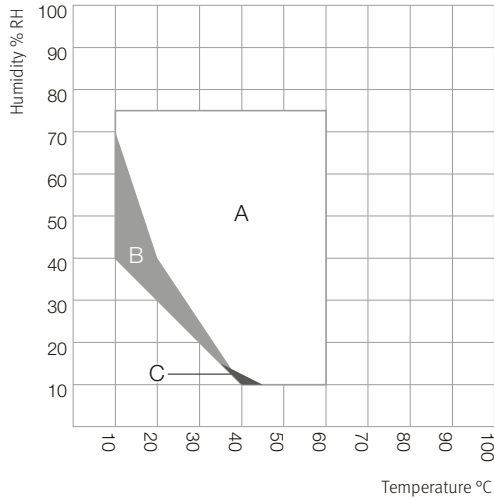

A: Guaranteed condensation-free range
 B: Time-limited operation (max. 24 hours)
 C: Deviations of technical data may be possible

KBF LQC 720

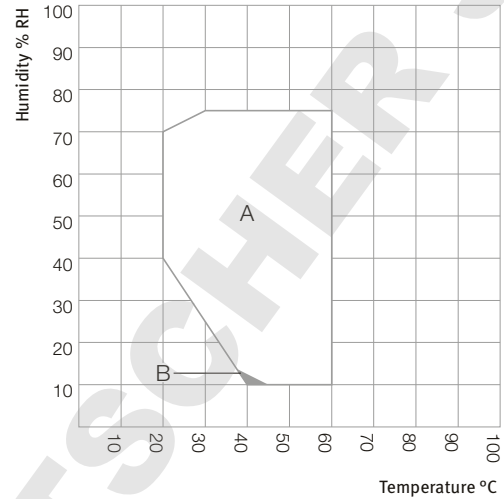

A: Guaranteed condensation-free range
 B: Deviations of technical data may be possible

DIMENSIONS incl. fittings and connections [mm]

KBF LQC 240

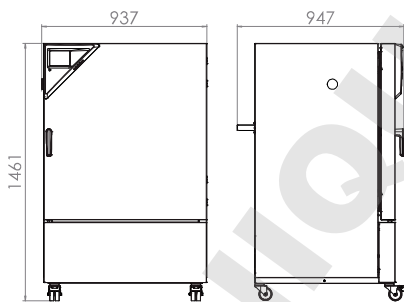

KBF LQC 720

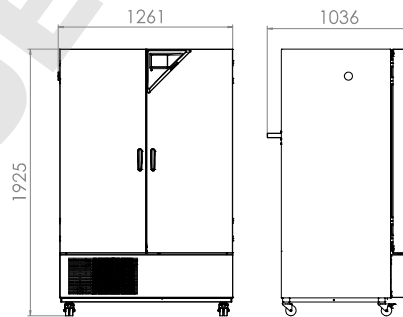

Series KMF | with expanded temperature / humidity range

The BINDER KMF ensures absolutely constant test conditions throughout the testing area. A big advantage of this constant climate chamber is its low space requirement and flexibility in terms of water supply. The wide temperature and humidity range make this constant climate chamber ideally suited for stress testing series.

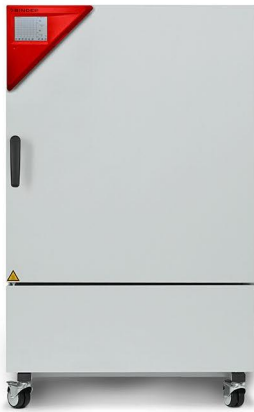

KMF 240 model

MAIN FEATURES

- Temperature range: -10 °C to 100 °C
- Humidity range: 10 % RH to 98 % RH
- APT.line™ preheating chamber technology
- Humidity regulation with capacitive humidity sensor and vapor humidification
- Inner chamber made of stainless steel
- BINDER Multi Management Software APT-COM™ Basic Edition
- Intuitive touchscreen controller with time-segment and real-time programming
- Internal data logger, measured values can be read out in open format via USB
- Unit self-test for comprehensive status analysis
- Tight-sealing inner door made of safety glass (ESG)

AVAILABLE SIZES

Model	Interior volume [L]	Online data sheets
KMF 115	102	› go2binder.com/en-KMF115
KMF 240	247	› go2binder.com/en-KMF240
KMF 720	700	› go2binder.com/en-KMF720



TIPS & TRICKS

Benefit from our many years of experience,

Tips & Tricks: › go2binder.com/en-tips-tricks

Case Studies: › go2binder.com/en-case-studies



Find all details online
go2binder.com/en-KMF

TECHNICAL DATA

Description	KMF 115	KMF 240	KMF 720
Outer dimensions			
Width net [mm]	880	930	1250
Height net [mm]	1050	1465	1925
Depth net [mm]	650	800	890
Internal Dimensions			
Width [mm]	600	650	973
Height [mm]	483	785	1250
Depth [mm]	351	485	576
Measures			
Interior volume [L]	102	247	700
Net weight of the unit (empty) [kg]	127	179	295
permitted load [kg]	100	100	150
Load per rack [kg]	30	30	45
Performance Data Temperature			
Temperature range [°C]	-10...100	-10...100	-10...100
Average heating-up rate according to IEC 60068-3-5 [K/min]	1.3	0.8	0.7
Average cooling down time according to IEC 60068-3-5 [K/min]	0.5	0.4	0.4
Performance Data Climate			
Temperature range [°C]	10...90	10...90	10...90
Temperature variation depending on setpoint [± K]	0.2...1	0.1...1	0.1...1
Temperature fluctuation depending on setpoint [± K]	0.1...0.3	0.1...0.3	0.1...0.5
Humidity range [% RH]	10...98	10...98	10...98
Humidity fluctuation depending on setpoint [± % RH]	≤2,5	≤2	≤2
Electrical data			
Nominal power (version 230 V) [kW]	2	2.1	3.1
Nominal power (version 240 V) [kW]	2	2.1	3.1
Fixtures			
Number of shelves (std./max.)	1/5	1/9	1/15

ORDERING INFORMATION [Art. No.]

Further details: Go to www.binder-world.com > Search > Enter Article Number

Voltage	Option model	KMF 115	KMF 240	KMF 720
200...230 V 1~ 50/60 Hz	Standard	9020-0341	9020-0343	9020-0345
200...240 V 1~ 50/60 Hz	Standard	9020-0342	9020-0344	9020-0346

► You will find a selection of options, accessories and services suitable for each product on page 18

EXTRACT OF FULLFILLED STANDARDS

- ICH Q1A(R2)

TEMPERATURE-HUMIDITY CHART

KMF 115, KMF 240, KMF 720

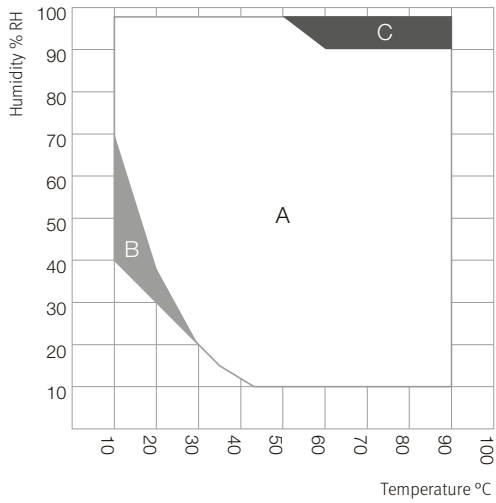

- A: Guaranteed condensation-free range
- B: Time-limited operation (max. 24 hours)
- C: Condensation in the inner chamber may be possible

DIMENSIONS incl. fittings and connections [mm]

KMF 115

KMF 240

KMF 720

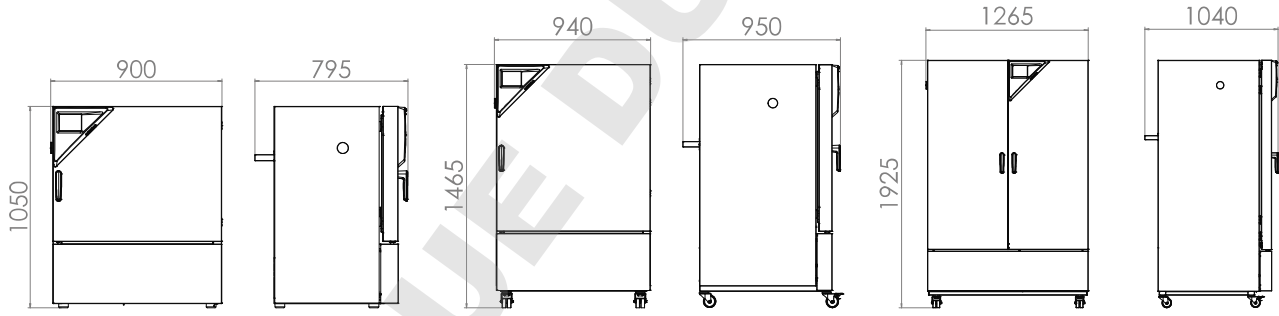

EXCERPT FROM OPTIONS AND ACCESSORIES

Access port with silicone plug

For introducing external measuring instruments. Large selection of different diameters and positions (left, right, or top)

Series KBF, KBF P, KBF LQC, KMF

BINDER PURE AQUA SERVICE

System for preparation or complete desalination of tap water, complete set containing PURE AQUA 300 single-use cartridge, measuring device, and all necessary connecting parts

Series KBF, KBF P, KBF LQC, KMF

Data Logger Kit TH

Independent temperature and humidity data logging. The tailored product solution contains helpful accessories: From the magnetic mounting of the data logger to the BINDER unit and securing sensor cable for accurate readings.

Series KBF, KBF P, KBF LQC, KMF

LED light bar sets

LED light bars in three different lengths (30, 50, 90 cm) can be easily and variably positioned in the BINDER unit, including various attachment options and control unit. Additional light bars can be added as desired.

Series KBF, KBF P, KBF LQC, KMF

Services

You can access our installation, maintenance, calibration, validation, or warranty services by taking out a Maintenance Service Agreement or by simply getting in touch when you need us. More information is available in the accessories and services chapter.

Series KBF, KBF P, KBF LQC, KMF

BINDER INDIVIDUAL

Using a BINDER series production product as a basis, we develop individual solutions as a single unit or in small batches. All products are tested, certified, and supplied with a full functional guarantee and warranty. More information is available in the accessories and services chapter.

Series KBF, KBF P, KBF LQC, KMF

► All extras online go2binder.com/en-options

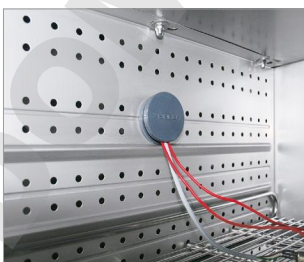

Access port with silicone plug



BINDER PURE AQUA Service



Data Logger



LED light strip sets

Solid.Line

NEW

With its new Solid.Line range, BINDER is expanding its product portfolio of drying and heating chambers, incubators, and constant climate chambers. This new line embodies **solid product design** with **great value for money**. The new Solid.Line is the ideal addition to BINDER's popular premium products, thus complementing the entire product range with BINDER's quality guarantee – Made in Germany.

DOMINIQUE DUTSCHER SAS

Solid.Line constant climate chambers

Series KBF-S Solid.Line

Page 24

Options and Accessories

Page 27

With its new Solid.Line range, BINDER is expanding its product portfolio. This new line embodies solid product design with great value for money. This is the ideal addition to BINDER's popular premium products, thus complementing the entire product range with BINDER's quality guarantee – Made in Germany.

PRODUCT SELECTION SOLID.LINE CONSTANT CLIMATE CHAMBERS

Features	Series KBF-S Solid.Line › Page 24
Model	
Model 115	•
Model 240	•
Model 720	•
Model 1020	•
General data	
Temperature range [°C]	0...70
Humidity range [% RH]	20...80
Ethernet interface	•
USB interface	•
Forced convection	•
Controller and timer functions	
Controller display	LCD
Adjustable fan speed	•
Class 3.1 independent temperature safety device	•
Temperature alarm, acoustic	•
Temperature alarm, visual	•
•Standard equipment	

ADVANTAGES AT A GLANCE



FAST AND PRECISE HUMIDIFICATION

Series KBF-S

The patented long-life steam humidification system and the capacitive humidity sensor ensure on target humidity values.



HOMOGENEOUS TEMPERATURE DISTRIBUTION

Series KBF-S

BINDER APT.line™ preheating chamber technology ensures long-term operational stability even under full load.



NO RISK OF CORROSION

Series KBF-S

Because the inner chamber and all fixtures are made entirely from stainless steel.

Series KBF-S Solid.Line | with large temperature / humidity range

The new Solid.Line KBF-S climate chamber is a custom-made solution for long-term testing and accelerated stability testing for pharmaceutical products in accordance with the ICH Q1A guideline. The corrosion-free and condensation-free interior also ensures exceptionally stable temperature and moisture levels, even when fully loaded.



Model KBF-S 720

MAIN FEATURES

- Temperature range: 0 °C to 70 °C
- Humidity range: 20% to 80% RH
- APT.line™ preheating chamber technology
- Humidity regulation with capacitive humidity sensor and steam humidification
- LCD to display temperature and humidity along with additional information and alarms
- Internal data logger, measured values can be read out in open format via USB
- Unit self-test for comprehensive status analysis
- Inner chamber made completely of stainless steel
- 2 stainless steel racks, incl. shelf supports
- Access port with silicone plug, 30 mm, left

AVAILABLE SIZES

Model	Interior volume [L]	Online data sheets
KBF-S 115	102	› go2binder.com/en-KBF-S115
KBF-S 240	247	› go2binder.com/en-KBF-S240
KBF-S 720	700	› go2binder.com/en-KBF-S720
KBF-S 1020	1020	› go2binder.com/en-KBF-S1020



Find all details online
go2binder.com/en-KBF-S

TECHNICAL DATA

Description	KBF-S 115	KBF-S 240	KBF-S 720	KBF-S 1020
Outer dimensions				
Width net [mm]	880	925	1250	1250
Height net [mm]	1050	1460	1925	1925
Depth net [mm]	650	800	890	1145
Internal Dimensions				
Width [mm]	600	650	973	976
Height [mm]	483	785	1250	1250
Depth [mm]	351	485	576	836
Measures				
Interior volume [L]	102	247	700	1020
Net weight of the unit (empty) [kg]	128	161	284	379
permitted load [kg]	100	100	150	150
Load per rack [kg]	30	30	45	45
Performance Data Temperature				
Temperature range [°C]	0...70	0...70	0...70	0...70
Temperature variation at 40 °C [± K]	0.3	0.3	0.3	0.3
Temperature fluctuation [± K]	–	0.1	0.1	–
Temperature fluctuation at 40 °C [± K]	–	–	–	0.1
Performance Data Climate				
Temperature range [°C]	10...70	10...70	10...70	10...70
Temperature variation at 40 °C and 75 % RH [± K]	0.3	0.3	0.3	0.3
Temperature fluctuation at 40 °C and 75 % RH [± K]	0.1	0.1	0.1	0.1
Humidity range [% RH]	20...80	20...80	20...80	20...80
Humidity fluctuation at 40 °C and 75 % RH [% RH]	2,0			
Electrical data				
Nominal power (version 230V) [kW]	1.4	1.4	2	2
Nominal power (version 240V) [kW]	1.4	1.4	2	2
Fixtures				
Number of shelves (std./max.)	2/5	2/9	2/15	2/15

ORDERING INFORMATION [Art. No.]

Further details: Go to www.binder-world.com > Search > Enter Article Number

Voltage	Option model	KBF-S 115	KBF-S 240	KBF-S 720	KBF-S 1020
200...230 V 1~ 50/60 Hz	Standard	9020-0370	9020-0366	9020-0368	9020-0372
200...240 V 1~ 50/60 Hz	Standard	9020-0371	9020-0367	9020-0369	9020-0373

► You will find a selection of options, accessories and services suitable for each product on page 27

EXTRACT OF FULLFILLED STANDARDS

- ICH Q1A(R2)

TEMPERATURE-HUMIDITY CHART

KBF-S 115, KBF-S 240, KBF-S 720, KBF-S 1020

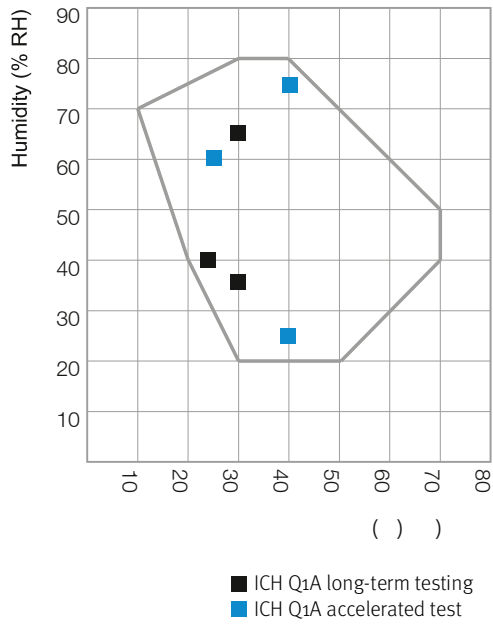

DIMENSIONS incl. fittings and connections [mm]

KBF-S 115

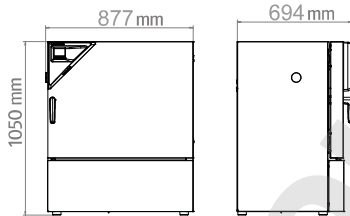

KBF-S 240

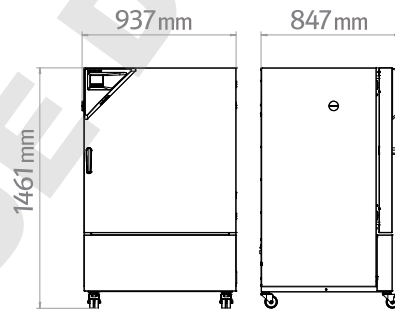

KBF-S 720

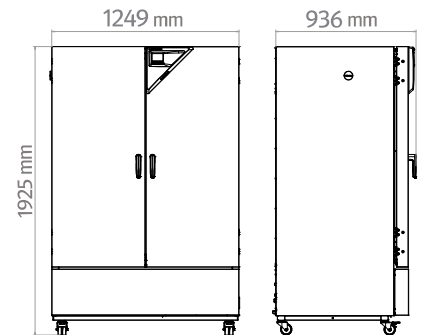

KBF-S 1020

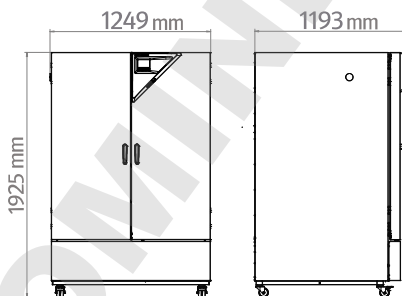

EXCERPT FROM OPTIONS AND ACCESSORIES

Access port with silicone plug	For introducing external measuring instruments. Large selection of different diameters and positions (left, right, or top) Series KBF-S
Convenient water supply	Flexible positioning of the water container with magnetic holder, hose adapter for water container with practical quick coupling, and water stop function. Series KBF-S
Data Logger Kit TH	Independent temperature and humidity data logging. The tailored product solution contains helpful accessories: From the magnetic mounting of the data logger to the BINDER unit and securing sensor cable for accurate readings. Series KBF-S
Services	You can access our installation, maintenance, calibration, validation, or warranty services by taking out a Maintenance Service Agreement or by simply getting in touch when you need us. More information is available in the accessories and services chapter. Series KBF-S

► All extras online go2binder.com/en-options

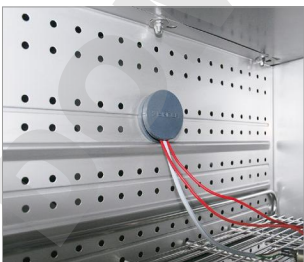

Access port with silicone plug



Convenient water supply



Data Logger



Services

BINDER products

CO₂ incubators

Incubators

Cooling incubators

Growth chambers

Ultralow temperature freezers

Drying and heating chambers

Safety drying chambers

Vacuum drying chambers

Constant climate chambers

Dynamic climate chambers



Never miss a product novelty -
Subscribe and keep up to speed with
the BINDER monthly newsletter.

Subscription

go2binder.com/en-newsletter-subscription



Best conditions for your success

BINDER GmbH

Tuttlingen, Germany

Tel +49 7462 2005 0
Fax +49 7462 2005 100
info@binder-world.com
www.binder-world.com

BINDER Asia Pacific (Hong Kong) Ltd.

Kowloon, Hong Kong, P.R. China

Tel +852 39070500
Fax +852 39070507
asia@binder-world.com
www.binder-world.com

BINDER Environmental Testing Equipment (Shanghai) Co., Ltd.

Shanghai, P.R.China

Tel +86 21 685 808 25
Fax +86 21 685 808 29
china@binder-world.com
www.binder-world.com

Representative Office for CIS

Moscow, Russia

Tel +7 495 988 15 16
Fax +7 495 988 15 17
russia@binder-world.com
www.binder-world.ru

BINDER Inc.

Bohemia, NY, USA

Tel +1 631 224 4340
Fax +1 631 224 4354
usa@binder-world.com
www.binder-world.us