

" *Resolve to Discover* " the syzygy of science, art & practicality.



GALILEO

bioscience



MANUAL



GALILEO
bioscience

Table of Contents

| | |
|--|-----|
| Cover Page | CP |
| TOC | TOC |
| Title Page/Contact Info..... | 1 |
| Warranty/Component Illustration..... | 2 |
| Packing Lists..... | 2 |
| Environmental Conditions/Safety Precautions..... | 3 |
| Instructions For Use | |
| Introduction..... | 4 |
| Safety Precautions..... | 4 |
| General Care & Cleaning..... | 5 |
| Specifications..... | 6 |
| Casting The Gel..... | 6 |
| Operation..... | 7 |
| Visualization..... | 8 |
| Troubleshooting..... | 8 |
| References..... | 9 |
| Appendix | |
| Agarose Preparation Notes..... | 10 |
| Comb Specifications..... | 12 |
| Accessories..... | 14 |
| Notes..... | 15 |





GALILEO
bioscience

**HORIZONTAL ELECTROPHORESIS
SYSTEM**

USER'S MANUAL rev. 0904



**THIS MANUAL APPLIES TO THE FOLLOWING GALILEO BIOSCIENCE
RAPIDCAST™ HORIZONTAL ELECTROPHORESIS SYSTEMS:**

80-0708, 80-0708L, 80-0911, 80-1214



WARNING



THESE UNITS ARE CAPABLE OF DELIVERING POTENTIALLY LETHAL VOLTAGE WHEN CONNECTED TO A POWER SUPPLY AND ARE TO BE OPERATED ONLY BY QUALIFIED TECHNICALLY TRAINED PERSONNEL.

PLEASE READ THE **ENTIRE** OPERATOR'S MANUAL THOROUGHLY BEFORE OPERATING THIS UNIT.

Galileo Bioscience
P. O. Box 390566
Cambridge, MA 02139
Toll Free: 877-481-9175
Tel: 781-481-9175
Fax: 781-481-9214

www.galileobioscience.com



WARRANTY

Please check that the unit has been received complete and undamaged. Refer to the illustration/table below and check that all components are present. Be sure to save all packaging and documents until you have thoroughly inspected your shipment, if you find that your order is incorrect or damaged, call for return instructions.

Galileo Bioscience (Galileo) guarantees that the Electrophoresis System you have received has passed rigorous quality assurance protocols and meets its published specification.

This warranty is valid for 36 months, only if the product has been used and cared for according to this user manual. No liability is accepted for loss or damage arising from incorrect use. **Galileo's** liability is limited to the repair or replacement of the unit or refund of the purchase price, at **Galileo's** option. **Galileo** is not liable for any consequential damages.

Galileo reserves the right to alter the specifications of the Electrophoresis Systems without prior notice. This will enable us to implement improvements as soon as they are available.

HORIZONTAL ELECTROPHORESIS SYSTEM COMPONENTS - 80-1214 SYSTEM SHOWN BELOW

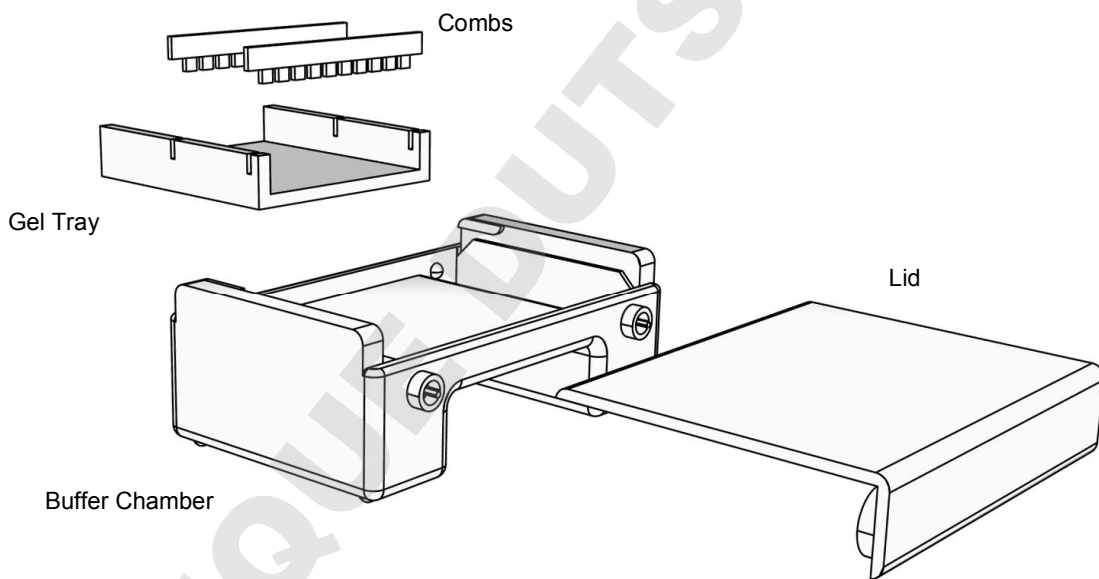

| Table A - INCLUDED SYSTEM COMPONENTS | | | | |
|--------------------------------------|---------|----------|---------|---------|
| | 80-0708 | 80-0708L | 80-0911 | 80-1214 |
| BUFFER CHAMBER | 1 | 1 | 1 | 1 |
| COVER (W/POWER CORDS) | 1 | 1 | 1 | 1 |
| GEL TRAY (GASKETED) | 1 | 1 | 1 | 1 |
| GEL TRAY (NON-GASKETED) | 0 | 1 | 0 | 0 |
| COMBS | 2 | 2 | 2 | 2 |



ENVIRONMENTAL CONDITIONS FOR USE

- This unit is intended for indoor use only
- This unit can be operated safely at an altitude of 2,000 m
- The normal operating temperature range is between 4°C and 65°C
- Maximum relative humidity 80% for temperatures up to 31°C decreasing linearly to 50% relative humidity at 40°C

SAFETY PRECAUTIONS

Please read the User Manual carefully before using the Horizontal Electrophoresis Unit. This manual contains important operating and safety information. Our electrophoresis units are designed to perform flawlessly for years in the most demanding laboratories. Please take the time to read the manual to ensure that you understand the safety and operating instructions to ensure the successful use of the unit. Alterations could cause serious injury to the user or the system.

Power to the unit is supplied by an external power supply. The power supply must meet safety standards for IEC 1010-1 regulations and must be ground isolated and incorporate a no load detecting circuit.

Power is supplied to the gel through the cover of the system providing a safety interlock to the user. Users should not attempt to operate this unit without the safety inter-locked cover in place.

- ⚠ Always disconnect the unit from the power supply before removing cover to avoid the risk of personal shock.
- ⚠ Running Conditions should not exceed the maximum operating voltage or current.
- ⚠ Do Not fill the Buffer Chamber with running buffer above the maximum fill line.
- ⚠ Always disconnect the unit from the power supply when you want to move the unit or add running buffer.
- ⚠ Use this apparatus only for its intended purpose as described in this manual. Do not use this product if the power cords are damaged or if any of its surfaces are cracked.



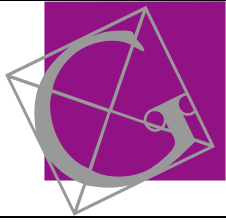

GALILEO
bioscience

GALILEO RAPIDCAST™ HORIZONTAL INSTRUCTIONS FOR USE

INTRODUCTION

Thank you for your purchase of a **Galileo RapidCast™ Horizontal** mini-gel electrophoresis system!

The Galileo RapidCast™ horizontal electrophoresis devices allow quick separation and analysis of nucleic acids on an agarose gel. Gels can be cast in a variety of ways:

- Use the gasketed trays directly in the buffer chamber
- Use multiple gasketed trays in optional casting trough
- Tape ends of trays
- Use one of the optional Adjustable Casting Platforms

The UV transparent gel trays are available with a variety of comb slot configurations. Combs are available in 1.0mm and 1.5mm thickness as well as a variety of tooth configurations to accommodate varying numbers of samples and sample volumes

Outstanding Features Ensure Trouble-Free Use

- Robust Acrylic Construction Stands up to Daily Usage Without Breakage, Warping or Leakage
- All Galileo Bioscience Horizontal Electrophoresis Systems Are Hand Fabricated, Providing Unmatched Durability For Years Of Daily Use
- Systems Meet or Exceed All Safety Requirements For The IEC1010-1 Standards
- Units Accommodate Gasketed Gel Trays, Allowing Casting Of Gels In The Buffer Chamber Without Tape, Dams or External Casting Stands.

USING HORIZONTAL GEL ELECTROPHORESIS UNITS

SAFETY PRECAUTIONS

- ⚠ **READ** all instructions before using the unit
- ⚠ **ALWAYS** turn off power supply **FIRST** then disconnect the power cords. Always have electrophoresis unit disconnected from their power supply before removing the safety cover.
- ⚠ **DO NOT** exceed the maximum operating voltage or current (**see TABLE B**)
- ⚠ **DO NOT** operate electrophoresis units in metal trays.
- ⚠ **DO NOT** fill the unit with running buffer above the maximum Fill Line
- ⚠ **DO NOT** move the unit when it is running
- ⚠ **CAUTION:** During electrophoresis very low quantities of various gases are produced at the electrodes. The type of gas produced depends on the composition of the buffer employed. To disperse these gases make sure that the unit is run in a well-ventilated area.



GENERAL CARE & CLEANING

WARNING !!

Acrylic is not resistant to aromatic or halogenated hydrocarbons, ketones or esters. Organic solvents cause acrylic to “craze” or crack. Do not use ethanol or other organic solvents to clean your unit. Do not autoclave, bake or microwave your unit.

- Δ Before using, clean and dry the unit. Clean with DISTILLED WATER ONLY; dry parts with clean, lint free lab wipes or, preferably, air dry. Use care when cleaning or drying the unit near the platinum wire. The connectors should be clean and dry before usage or storage.
- Δ Do not use abrasive creams or scourers.
- Δ Do not use cleaning brushes in the electrode area
- Δ A thorough rinse with distilled water is all that is generally required to clean the unit after use. A mild detergent may also be used. Acrylic can also be exposed to a mild bleach solution (10:1). In addition RNase removal products are also safe for acrylic.

See Page

GEL TRAY

All Galileo gel trays are made from UV transmissible acrylic, which allows a stained agarose gel to be viewed directly in the tray on a transilluminator. An incorporated fluorescent ruler aids in the calculation of relative mobility of DNA fragments.

NOTE: care should be taken to avoid pouring freshly melted agarose directly into the gel tray, as this may damage the tray. Always allow agarose to cool to 60°C before pouring into the tray.

COMBS

Combs for the Galileo Horizontal Electrophoresis Systems are available in thickness of 1.0mm and 1.5mm. Please see **Appendix - Comb Specifications** in the rear of this manual for details of combs available for each device. Comb spines are acrylic and teeth are polycarbonate. Combs designated “MT” are compatible for use with a multi-channel pipettor. Each comb is labeled with thickness, number of teeth and catalog number.

BUFFER TANK

The buffer tank holds the buffer and gel tray. Current is passed from the power supply through the leads to the cover connectors, through the platinum wires and into the buffer and from there into the gel. The cover has incorporated safety rings that prevent human contact with the electrode connections to prevent electrical shock if the power supply is accidentally not turned off prior to removing the lid. Users should not attempt to operate the system without the lid in place. The electrode banana plugs are color-coded red and black to ensure that the gel is placed in the correct orientation in the tank [**almost all electrophoretic separations of biomolecules run from the black electrode (negative) to the red electrode (positive)**]. The connection between the banana plug and the electrode wire is sealed with a proprietary composite that eliminates corrosion of the connection. The electrode wires are 0.254mm platinum and are secured to the inner walls of the tank. Care should be taken not to damage the electrodes when cleaning the unit.



SPECIFICATIONS

| | 80-0708 | 80-0708L | 80-0911 | 80-1214 |
|--------------------------------------|--------------------------------------|--------------------------------------|---|--|
| Gel Dimensions | 7x8cm (gasketed) 7x10cm (flush) | 7x8cm (gasketed) 7x10cm (flush) | 9x11cm (gasketed) | 12x14cm (gasketed) 12x14cm (flush) |
| System Dimensions (cm, L x W x H) | 17.6 x 12 x 9.5 | 17.6 x 12 x 9.5 | 22 x 15 x 9.5 | 24.5 x 18 x 9.5 |
| Tray Configuration | 2 comb slots | 2 comb slots | 2 comb slots | 2, 4, 12 comb slots |
| Comb thickness | 1.0mm or 1.5mm polycarbonate | | | |
| Comb configurations | 5, 6, 8, 10 and 12 wells & Prep Comb | 5, 6, 8, 10 and 12 wells & Prep Comb | 5, 8, 10, 12, 14, MT9, MT18 wells & Prep Comb | 8, 16, 20, 24, MT9, MT12, MT25 wells & Prep Comb |
| Voltage Limit | 150 volts | 150 volts | 150 volts | 150 volts |
| Max. Buffer volume | 400 mls | 400 mls | 600 mls | 800 mls |

CASTING THE GEL

- Place the gel tray on a flat, level surface. It is important to pour the agarose gel on a level surface to prevent uneven migration of samples through the gel. If casting tape is to be used, tightly secure the tape over the open ends of the tray. If using a gasketed tray place the tray into the chamber of the device so that the gasketed ends press against the walls of the buffer chamber. Make sure that the gel tray is pressed all the way down and rests on the unit's gel tray platform.
 - If the optional Adjustable Casting Platform is to be used, ensure that the platform is level using the three point leveling system and place the tray into the casting platform with the open ends facing the gasket. Position the center hole of the sliding arm of the caster over the correct hole in the base and insert the cam into the hole in the arm and through to the hole in the platform with the cam pin facing the tray. Rotating the cam pin 180° will force the tray forward and bring both gaskets into position on either side of the tray. If the tray is correctly positioned with the gaskets, it should not move when gently pushed from the side.
- Prepare agarose for use in the device. Refer to the **Agarose Preparation Table** in the **Appendix** for type and quantity of agarose needed (be sure to reference the manufacturers' instructions for any specific requirements for the agarose being used).
- Weigh out the appropriate amount of agarose and empty into an Erlenmeyer flask. Add buffer to flask. TBE or TAE buffer are the most widely used buffer choices for DNA separations (see Appendix for buffer formulations). Heat agarose in microwave until all powder has gone into solution. Swirl flask to be sure all agarose has dissolved.
- IMPORTANT: to avoid damage to UVT tray, always cool agarose to 60°C before pouring into tray.** Any bubbles that form while pouring may be popped with a small glass pipette or the edge of the comb. Place combs into the comb slots on the gel tray being careful not to create bubbles along the teeth of the comb. If the entire gel length is required for separation, place one comb in the first comb slot on the tray. To separate more samples on one gel, use both comb slots on the tray. Allow gel to solidify for 30 minutes.

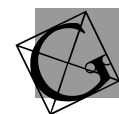

OPERATION

1. Once the agarose has solidified, carefully remove the casting tape from the gel tray or the gel tray from the casting platform. If a gasketed tray is used, carefully lift the tray out of the chamber, turn it 90° and replace it into the chamber. Remove casting comb(s) slowly to prevent any tearing of the wells.

NOTE: If a high percentage agarose gel is cast it may be difficult to remove the casting comb from the tray. If resistance is felt when removing the casting comb, place the gel tray into the buffer tank and add buffer before removing the casting comb

Place the tray onto the platform of the tank. Be sure the gel tray is placed in the proper orientation in the tank; the first comb slot should be closest to the black (cathode) electrode. The banana plugs on the tank are color coded to help ensure proper orientation.

2. Pour the buffer into the tank. Refer to the Appendix for buffer preparation. The level of buffer should cover the gel by at least 2-3mm. Check **SPECIFICATIONS (page 6 of this manual)** for buffer volume guidelines. A fill line is located on the outside wall of the tank for easy reference. Too little buffer may cause the gel to dry out during the run, while excess buffer may slow DNA migration in the gel.
3. Dilute sample with appropriate volume of 10X Loading Buffer (see Appendix for formula). Load samples. A dark acrylic Well Visualization Guide is included with each Horizontal Electrophoresis System to allow a clear view of the wells when loading samples. To use, simply slide the Well Visualization Guide under the tank, below the platform. To load samples, angle pipette tip into the well and slowly underlay sample into the well. Take care not to push pipette tip through the bottom of the sample well as this will result in significant well-to-well leakage of samples
4. Slide the cover onto the electrophoresis buffer tank, insuring complete connection of the tank's banana plugs to the female connector ends of the power cords that are fixed to the cover. The cover acts as a safety inter-lock to prevent accidental shock during operation.
5. Attach the power cords to the power supply. Turn on the power supply and set to the appropriate voltage level and begin electrophoresis.

Recommended running conditions are 5 volts/cm of inter-electrode distance:

| Model | Inter-electrode Distance | Voltage |
|-------------------|---------------------------------|------------------------------|
| 80-0708, 80-0708L | 18 cm | 90V or 110volts constant |
| 80-0911 | 19 cm | 95V or 110 volts constant |
| 80-1214 | 22.5 cm | 112.5V or 110 volts constant |
| | | |

6. Run the gel for the appropriate amount of time for the specific sample being analyzed or until the dye front has migrated to approximately 5mm from the end of the gel. Turn off power supply and detach the power cords. Slide the cover back to remove. Lift the gel tray out of the buffer tank and proceed with visualization.
7. It is important to rinse the tank with distilled water after every use to keep it clean. It is recommended to allow the tank to air dry, rather than drying with a wipe or towel, to avoid damage to the electrode wires.

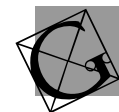

VISUALIZATION

1. Stain the gel with ethidium bromide solution or other suitable stain for agarose gels. **Note: Ethidium bromide is a mutagen and can cause serious skin and eye irritation. Wear gloves and safety glasses when handling.**
 - 1.1. Ethidium Bromide Staining: Once electrophoresis has been completed, prepare 200ml of staining solution. Add 10 μ l of 10mg/ml ethidium bromide solution to 200ml de-ionized water. Soak the gel for 15 minutes with gentle shaking and then de-stain in fresh de-ionized water for 15 minutes. Gel may then be viewed using a transilluminator. The gel tray is made of UV transmissible acrylic and therefore may be placed directly on the transilluminator to view the gel.
 - 1.2. For quicker viewing of bands on the gel, ethidium bromide solution may be added directly to the agarose gel before it is poured. To use this method add ethidium solution to gel and to the running buffer in a concentration of 0.5 μ g/ml.

TROUBLESHOOTING

Many factors may affect the quality of gel preparations. For example, preparation of gel and sample buffers, gel casting and tank assembly and/or run conditions. Reading and following the instructions in this operating manual can solve most problems. Below we list some of those most commonly experienced problems along with suggestions for solving them.

Problem: Gel “Smiling”

- Gel may be uneven. Be sure to pour gel on a level surface.
- Voltage may be too high. Lower voltage setting on power supply. See Instructions for proper voltage.

Problem: No migration

- No power is contacting the gel. Be sure all contacts are made between the power supply and the electrophoresis tank.
- Check buffer preparation to be sure the proper ionic strength buffer was prepared.
- Check integrity of electrodes to be sure no breakage has occurred. Any breaks in the electrode will cause slow migration or none at all. If a break is found contact Galileo.

Problem: Slow migration

- Check buffer preparation to be sure the proper ionic strength buffer was prepared.
- Voltage too low, increase voltage, see Instructions for proper running conditions.
- Check integrity of electrodes to be sure no breakage has occurred. Any breaks in the electrode will cause slow migration or none at all. If a break is found contact the Galileo.

Problem: Excessive heat

- Ionic strength of buffer is too high. Check buffer preparation to be sure the proper ionic strength buffer was prepared.



- Voltage is too high, decrease the voltage; see Table C for proper running conditions.

Problem: One side of gel running slower

- Gel may be uneven. Be sure to pour gel on a level surface.
- Check integrity of electrodes to be sure no breakage has occurred. Any breaks in the electrode may cause uneven migration or none at all. If a break is found contact Galileo.

Problem: No bands visible

- Be sure gel was placed in the electrophoresis tank in the proper orientation. If orientation or polarity is reversed, the samples will migrate off the gel.
- If DNA marker was used and is present on the gel check the integrity of the sample.
- Shorten run time. Gel should be stopped when the dye front has migrated to approximately 5mm from the end of the gel.

Additional sources for Reference

Maniatis T., E. F. Fritsch and J. Sambrook. **Molecular Cloning: A Laboratory Manual**, Cold Spring Harbor Laboratory, Cold Spring Harbor, NY.

Short Protocols in Molecular Biology - A Compendium of Methods from Current Protocols in Molecular Biology, Edited by Frederick M. Ausubel, et. al.

Adams, D., and R. Ogden, **Electrophoresis in Agarose and Acrylamide Gels, Methods in Enzymology**, Vol. 152 (1987) Academic Press, Inc.

Fotador, U., **Simultaneous Use of Standard and Low-Melting Agarose for the Separation and Isolation of DNA by Electrophoresis**, BioTechniques, Vol. 10, No. 2, (1991)

Boots, S., **Gel Electrophoresis of DNA**, Analytical Chemistry, Vol. 61, No. 8, April 15, 1989



APPENDIX

AGAROSE PREPARATION NOTES

Preparation & Properties of TAE and TBE Electrophoresis Buffer Systems:

These buffers are used because they both have a basic pH that gives the phosphate group of the DNA a net negative charge allowing migration of the DNA toward the positive (red) anode in the gel unit.

TAE - Tris-Acetate with EDTA (40 mM Tris-Base, 40 mM Acetic Acid, 1 mM EDTA)

| 50X Stock Solution, pH ~8.5 | 1X Working Solution |
|---|---------------------|
| 242g Tris-Base | 40mM Tris-Acetate |
| 57.1 ml Glacial Acetic Acid | 1mM EDTA |
| 100 ml 0.5M EDTA (pH 8.0) | |
| Distilled Water to 1 Liter Final Volume | |

TBE - Tris Borate with EDTA (89 mM Tris Base, 89mM Boric Acid, 2 mM EDTA)

| 10X Stock Solution | 1X Working Solution |
|-----------------------------------|---------------------|
| 108g Tris Base | 89mM Tris Base |
| 55g Boric Acid | 89mM Boric Acid |
| 20 ml 0.5M EDTA (pH 8.0) | 2mM EDTA |
| Distilled Water to 1 Liter Volume | |
| DO NOT ADJUST pH | |

| | <u>Suggested Uses & Comments</u> |
|-------------------|--|
| TAE Buffer | Use when DNA is to be recovered (i.e by low melting agarose gels) |
| | Use for electrophoresis of large (>20kb) DNA fragments |
| | Applications requiring high resolution |
| | Under conditions with low ionic strength and low buffering capacity - re-circulation may be necessary for long runs (>4 hours) |
| TBE Buffer | Use for electrophoresis of small (<1kb) DNA fragments |
| | Better resolution of small (<1lb) DNA fragments |
| | Decreased DNA mobility |
| | High ionic strength and high buffering capacity - no re-circulation needed for extended run times. |

TBE Buffer reacts with the agarose making smaller pores and a tighter matrix. This reduces broadening of the DNA bands for sharper resolutions.

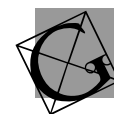

Agarose:

Required volume of gel: gel width x gel length x gel thickness

| Gel size (cm) | x | Gel thickness (cm) | = | Gel Volume (ml) |
|---------------|---|--------------------|---|-----------------|
| 7 x 8 cm | | 0.25 cm | | 14.0 ml |
| 7 x 8 cm | | 0.50 cm | | 28.0 ml |
| 7 x 8 cm | | 0.75 cm | | 42.0 ml |
| 7 x 10 cm | | 0.25 cm | | 17.5 ml |
| 7 x 10 cm | | 0.50 cm | | 35.0 ml |
| 7 x 10 cm | | 0.75 cm | | 52.5 ml |
| 9 x 11 cm | | 0.25 cm | | 24.8 ml |
| 9 x 11 cm | | 0.50 cm | | 49.5 ml |
| 9 x 11 cm | | 0.75 cm | | 74.2 ml |
| 12 x 14 cm | | 0.25 cm | | 42.0 ml |
| 12 x 14 cm | | 0.50 cm | | 84.0 ml |
| 12 x 14 cm | | 0.75 cm | | 126.0 ml |

Agarose percentage and separation of DNA-fragments

| Percentage (w/v) | Agarose (g) | Buffer (ml) | Separation Range (kb) |
|------------------|-------------|-------------|-----------------------|
| 0.3 | 0.15 | 50 | 5-60 |
| 0.5 | 0.25 | 50 | 1-30 |
| 0.7 | 0.35 | 50 | 0.8-12 |
| 1.0 | 0.50 | 50 | 0.5-10 |
| 1.2 | 0.60 | 50 | 0.3-7 |
| 1.5 | 0.75 | 50 | 0.2-4 |
| 2.0 | 1.00 | 50 | 0.1-3 |
| 3.0 | 1.50 | 50 | <0.1 |

Agarose Gel Loading Buffer

Samples are prepared and combined with gel loading buffer before being loaded into the prepared gel. Sample buffer usually contains similar components to the running buffer, dyes for visibility, and glycerol to provide some weight to the samples. This increased sample density and color allows easy visualization of the samples and ensures samples load evenly into the wells and do not float out during loading. Dyes also migrate toward the anode end of the electrophoresis chamber at predictable rates allowing the gel run to be monitored.

The most commonly used loading buffer is glycerol, bromophenol blue, and xylene cyanol.

6x loading buffer for agarose gels:

- 0.25% bromophenol blue
- 0.25% xylene cyanol FF
- 30% glycerole in water



COMB SPECIFICATIONS

NOTE: Well volumes are calculated assuming a 0.5cm thick gel. Since the comb placement leaves 0.2 cm of agarose under the sample well, a 0.5 cm thick gel will have sample well that is 0.3 cm deep (a 1 cm thick gel would leave a sample well depth of 0.8 cm). Loading Volume is calculated as:

Thickness of Tooth x Width of Tooth x Depth of Sample (gel thickness - 0.2cm) x 75%

MODEL 80-0708 & 80-0708L

| Galileo Comb ID | Number teeth | Thickness (mm) | Width (mm) | Well volume (μl) | | |
|-----------------|--------------|----------------|------------|------------------|--------|--------|
| | | | | 0.5cm | 0.75cm | 1.0cm |
| 80-0708-C5-1.0 | 5 | 1.0 | 11.3 | 25 | 47 | 68 |
| 80-0708-C6-1.0 | 6 | 1.0 | 9.1 | 20 | 38 | 55 |
| 80-0708-C8-1.0 | 8 | 1.0 | 6.4 | 14 | 26 | 38 |
| 80-0708-C10-1.0 | 10 | 1.0 | 4.7 | 11 | 19 | 28 |
| 80-0708-C12-1.0 | 12 | 1.0 | 3.7 | 8 | 15 | 22 |
| 80-0708-C5-1.5 | 5 | 1.5 | 11.3 | 38 | 70 | 102 |
| 80-0708-C6-1.5 | 6 | 1.5 | 9.1 | 31 | 56 | 82 |
| 80-0708-C8-1.5 | 8 | 1.5 | 6.4 | 22 | 40 | 58 |
| 80-0708-C10-1.5 | 10 | 1.5 | 4.7 | 16 | 29 | 42 |
| 80-0708-C12-1.5 | 12 | 1.5 | 3.7 | 12 | 23 | 33 |
| 80-0708-PREP | 2 | 1.5 | 57/4.7 | 193/16 | 353/29 | 513/42 |

MODEL 80-0911

| Galileo Comb ID | Number teeth | Thickness (mm) | Width (mm) | Well volume (μl) | | |
|-------------------|--------------|----------------|------------|------------------|--------|--------|
| | | | | 0.5cm | 0.75cm | 1.0cm |
| 80-0911-C5-1.0 | 5 | 1.0 | 15.4 | 25 | 47 | 68 |
| 80-0911-C8-1.0 | 8 | 1.0 | 9.0 | 20 | 38 | 55 |
| 80-0911-C10-1.0 | 10 | 1.0 | 6.8 | 14 | 26 | 38 |
| 80-0911-C12-1.0 | 12 | 1.0 | 5.4 | 11 | 19 | 28 |
| 80-0911-C14-1.0 | 14 | 1.0 | 3.7 | 8 | 15 | 22 |
| 80-0911-CMT9-1.0 | 9 | 1.0 | 7.2 | 16 | 30 | 43 |
| 80-0911-CMT18-1.0 | 18 | 1.0 | 2.7 | 6 | 11 | 16 |
| 80-0911-C5-1.5 | 5 | 1.5 | 11.3 | 38 | 70 | 102 |
| 80-0911-C6-1.5 | 6 | 1.5 | 9.1 | 31 | 56 | 82 |
| 80-0911-C8-1.5 | 8 | 1.5 | 6.4 | 22 | 40 | 58 |
| 80-0911-C10-1.5 | 10 | 1.5 | 4.7 | 16 | 29 | 42 |
| 80-0911-C12-1.5 | 12 | 1.5 | 3.7 | 12 | 23 | 33 |
| 80-0911-C14-1.5 | 14 | 1.5 | | | | |
| 80-0911-CMT9-1.5 | 9 | 1.5 | 7.2 | 24 | 45 | 65 |
| 80-0911-CMT18-1.5 | 18 | 1.5 | 2.7 | 9 | 17 | 24 |
| 80-0911-PREP | 2 | 1.5 | 57/4.7 | 193/16 | 353/29 | 513/42 |

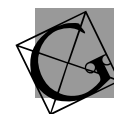

| Galileo Comb ID | No. of teeth | Thickness (mm) | Width (mm) | Well volume (μ l) | | |
|-------------------|--------------|----------------|------------|------------------------|--------|---------|
| | | | | 0.5cm | 0.75cm | 1.0cm |
| 80-1214-C8-1.0 | 8 | 1.0 | 12.5 | 28 | 52 | 75 |
| 80-1214-C16-1.0 | 16 | 1.0 | 5.4 | 12 | 22 | 32 |
| 80-1214-C20-1.0 | 20 | 1.0 | 3.9 | 9 | 16 | 23 |
| 80-1214-C25-1.0 | 24 | 1.0 | 3.0 | 7 | 12 | 18 |
| 80-1214-CMT9-1.0 | 9MT | 1.0 | 7.2 | 16 | 30 | 43 |
| 80-1214-CMT12-1.0 | 12MT | 1.0 | 7.2 | 16 | 30 | 43 |
| 80-1214-CMT25-1.0 | 25MT | 1.0 | 2.7 | 6 | 11 | 16 |
| 80-1214-C8-1.5 | 8 | 1.5 | 12.5 | 42 | 77 | 113 |
| 80-1214-C16-1.5 | 16 | 1.5 | 5.4 | 18 | 33 | 49 |
| 80-1214-C20-1.5 | 20 | 1.5 | 3.9 | 13 | 24 | 35 |
| 80-1214-C24-1.5 | 24 | 1.5 | 3.0 | 10 | 19 | 27 |
| 80-1214-CMT9-1.5 | 9MT | 1.5 | 7.2 | 24 | 45 | 65 |
| 80-1214-CMT12-1.5 | 12MT | 1.5 | 7.2 | 24 | 45 | 65 |
| 80-1214-CMT25-1.5 | 25MT | 1.5 | 2.7 | 9 | 17 | 24 |
| 80-1214-PREP | Prep Comb | 1.5 | 106.2/4.7 | 358/15 | 657/29 | 956/42- |
| 80-1214-WALL | Wall Comb | 1.5 | | | | - |



ACCESSORIES AVAILABLE FOR GALILEO HORIZONTAL UNITS

RapidCast™ 80-0708 & 80-0708L

| | |
|--------------|---|
| 80-0708-RCGT | RapidCast™ Gel Tray for 7cmW x 8cmL gels, 2 comb slots |
| 80-0708-LGT | Flush-Cut Gel Tray for 7cmW x 10cmL gels, 2 comb slots |
| 80-0708-RCGC | RapidCast™ Gel Caster, only , will hold (1-3) 80-0708-RCGT |
| 80-0708-RCPK | RapidCast™ Gel Caster Pack, includes (3) 80-0708-RCGT |
| 80-0708-GSK | Replacement Gaskets for 80-0708-RCGT (2) |
| 80-MADJ-CST | Mini-Adjustable Horizontal Gel Caster, can be used with 8, 10, 11, 14 cm Long Gel Trays, up to 12cm Wide |
| 80-WADJ-CST | Wide-Adjustable Horizontal Gel Caster, can be used with 8, 10, 11, 14, & 17 cm Long Gel Trays, up to 23 cm Wide |

RapidCast™ 80-0911

| | |
|--------------|---|
| 80-0911-RCGT | RapidCast™ Gel Tray for 9cmW x 11cmL gels, 2 comb slots |
| 80-0911-RCGC | RapidCast™ Gel Caster, only , will hold (1-3) 80-0911-RCGT |
| 80-0911-RCPK | RapidCast™ Gel Caster Pack, includes (3) 80-0911-RCGT |
| 80-0911-GSK | Replacement Gaskets for 80-0911-RCGT (2) |
| 80-MADJ-CST | Mini-Adjustable Horizontal Gel Caster, can be used with 8, 10, 11, 14 cm Long Gel Trays, up to 12cm Wide |
| 80-WADJ-CST | Wide-Adjustable Horizontal Gel Caster, can be used with 8, 10, 11, 14, & 17 cm Long Gel Trays, up to 23 cm Wide |

RapidCast™ 80-1214

| | |
|------------------|---|
| 80-1214-RCGT2 | RapidCast™ Gel Tray for 12cmW x 14cmL gels, 2 comb slots |
| 80-1214-RCGT4 | RapidCast™ Gel Tray for 12cmW x 14cmL gels, 4 comb slots |
| 80-1214-RCGT12 | RapidCast™ Gel Tray for 12cmW x 14cmL gels, 12 comb slots |
| 80-1214-RCGC | RapidCast™ Caster only , holds (3) Gasketed 12 x 14 cm trays |
| 80-1214-RCPK | RapidCast™ Caster Pack includes (3) 80-1214-RCGT2 |
| 80-1214-GSK | Replacement Gasket, Pair |
| 80-1214-UVT2 | Flush Cut Gel Tray for 12cmW x 14cmL gels, 2 comb slots |
| 80-1214-UVT4 | Flush Cut Gel Tray for 12cmW x 14cmL gels, 4 comb slots |
| 80-1214-UVT12 | Flush Cut Gel Tray for 12cmW x 14cmL gels, 12 comb slots |
| 80-MADJ-CST | Mini Adjustable Horizontal Gel Caster, accommodates gel trays 8, 10, and 14 cm long, up to 12cm wide |
| 80-WADJ-CST | Maxi Adjustable Horizontal Gel Caster, accommodates (3) 8cm and 10cm long trays, (2) 12 x 14 cm long trays and (1) 23cmW x 14cmL gel tray |
| 80-1214-MT25-SLG | Sample Loading Guide for 25 tooth comb (12 x 2) plus 1, 2X micro-titer format, for improved reliability of loading with multi-channel pipette |

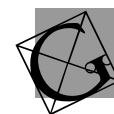

DOMINIQUE DUTSCHER SAS



DOMINIQUE DUTSCHER SAS

