

Instruction manual SMART

Thermostatic cabinets

models: ST 1, ST 2, ST 3, ST 4, ST 5, ST 6,
ST 500, ST 700, ST 1200, ST 1450,
ST 500 M, ST 700 M, ST 1200 M, ST 1450 M,

Laboratory refrigerators

models: CHL 1, CHL 2, CHL 3, CHL 4, CHL 5, CHL 6,
CHL 500, CHL 700, CHL 1200, CHL 1450
CHL 500 M, CHL 700 M, CHL 1200 M, CHL 1450 M

Multichamber devices

models: ST 1/1, ST 1/1/1, ST 2/2, ST 2/3
CHL 1/1, CHL 1/1/1, CHL 2/2, CHL 2/3
ST1/CHL1, ST2/CHL2, ST2/CHL3

Laboratory incubators

models: ILW 53, ILW 115, ILW 240, ILW 400, ILW 750

Before using the equipment, please read carefully this instruction manual!

Version 1.41

Issued 03.03.2025



Manufacturer's address:

POL-EKO® A.Polok-Kowalska sp.k.
ul. Kokoszycka 172 C
44-300 Wodzisław Śląski
Country of origin: Polska



As the manufacturer of this device, we want to assure you that we have taken every step to ensure it meets your expectations and provides reliable performance over a long period of use. We are constantly improving our products and expanding our offerings, so we welcome any suggestions you may have regarding additional features or operational enhancements. Please feel free to visit our website at www.pol-eko.com.pl for more information.



The manufacturer takes every possible measure to eliminate post-production contamination. However, small oily residues from material processing, such as contact between tools and the processed parts, may still be present. To remove these residues, use a soft cloth or paper towel dampened with warm water and a degreasing solution.

As a manufacturer, we inform you that we took the necessary measures to ensure that this device fully meets your expectations and is reliable for a long period of use. Due to the continuous improvement of our products, as well as the expansion of our offer, any suggestions regarding additional functions and equipment functioning are welcome. Visit our homepage www.pol-eko.com.pl/home-en/

Equipment disposal

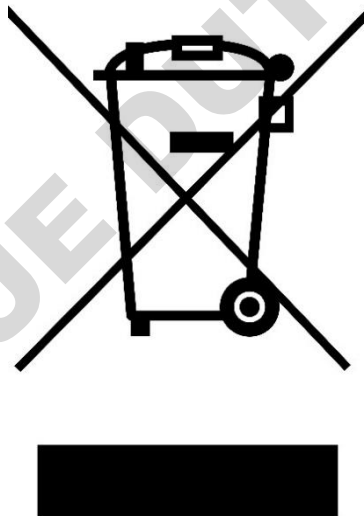













This equipment is marked with the crossed out wheeled bin symbol to indicate that this equipment must not be disposed of with unsorted waste. Instead it's your responsibility to correctly dispose of your equipment at lifecycle -end by handling it over to an authorized facility for separate collection and recycling. It's also your responsibility to decontaminate the equipment in case of biological, chemical and/or radiological contamination, so as to protect from health hazards the persons involved in the disposal and recycling of the equipment. For more information about where you can drop off your waste of equipment, please contact your local dealer from whom you originally purchased this equipment.

By doing so, you will help to conserve natural and environmental resources and you will ensure that your equipment is recycled in a manner that protects human health.

Thank you!

Contents:

1. INTENDED USE AND IMPORTANT INFORMATION FOR THE USER	6
2. PACKAGE CONTENTS	7
3. BEFORE THE FIRST USE	8
3.1. Installation of shelves.....	10
3.2. Condensation in the chamber	13
3.3. Remarks on the placement of samples	13
3.4. Closing chamber door.....	13
3.5. Anchoring of the equipment	14
4. DESCRIPTION OF THE DEVICE	15
4.1. Design of ST / CHL devices	15
4.2. Design of ILW devices	18
5. DEVICE EQUIPMENT (standard and optional)	20
5.1. Internal glass door (optionally for ST / CHL, standard for ILW)	20
5.2. External glass door (optionally for ST/CHL)	20
5.3. External door with viewing window (optionally for ILW)	20
5.4. Drawer on powder-coated slides.....	21
5.4.1. Drawers adjustment	21
5.5. Internal socket (optionally for ST, CHL, ILW)	22
5.6. Door lock (standard in ST, CHL, ILW).....	22
5.7. Access port for external sensor (standard for ST, CHL, ILW).....	22
5.8. Open door alarm (standard for ST, CHL, ILW)	23
5.9. Internal LED light (standard for ST, CHL optionally for ILW)	23
5.10. USB port (standard for ST, CHL, ILW)	23
5.11. Photoperiod FOT (optionally for ST and ILW)*	24
5.12. Display battery backup (optionally for ST, CHL, ILW).....	25
5.13. Consumables.....	26
6. DEVICE OPERATION	26
6.1. External memory (USB flash drive)	26
6.2. First boot.....	26
6.3.  Main screen	28
6.3.1. Information panel.....	29
6.3.2. The meaning of icons and symbols	31
6.3.3. Upper expandable and configurable menu	33
6.3.4. Alarm bar	35

6.4.		Quick program	35
6.5.		Programs	37
6.5.1.		Creating / editing a program	38
6.5.2.		Segments edition.....	38
6.5.3.		Summary of segments	40
6.5.4.		Protection class.....	41
6.5.5.		Temperature protection (option)	42
6.5.6.		Priority.....	42
6.5.7.		Loop.....	42
6.5.8.		Defrosting program (only for CHL 1-6, CHL 500, CHL 700, CHL 1200, CHL 1450) ^{1,2}	43
6.5.9.		Photoperiod FOT programming (optionally for ST and ILW)	43
6.6.		Starting the program	44
6.6.1.		The first way.....	44
6.6.2.		The second way	45
6.7.		Quick Change of parameters	46
6.7.1.		Quick change of set temperature.....	46
6.7.2.		Quick change of set time	47
6.7.3.		Quick change of fan efficiency (only for ILW).....	48
6.8.		Statistics.....	49
6.9.		Data record	50
6.10.		Event log.....	51
6.11.		Info.....	53
6.12.		User settings panel	54
6.12.1.		Unlocking the touch screen	55
6.13.		Time.....	55
6.14.		Alarms.....	56
6.14.1.		Alarms when set parameters are exceeded	56
6.14.2.		Open door alarm	58
6.14.3.		STM function.....	59
6.14.4.		Mute option	61
6.15.		Network.....	61
6.16.		Automatic defrosting function (optionally for ST 1-6, ST 500-1450, CHL 1-6, CHL 500-1450, ILW, standard for ST 500 M-1450 M i CHL 500 M-1450 M) ^{*1}	62
6.17.		Corrections	63
7.		INTERFACE.....	64
7.1.		MODBUS TCP.....	64

8. TEMPERATURE PROTECTION	64
8.1. Temperature protection class.....	64
9. CONNECTING THE DEVICE TO A COMPUTER.....	65
10. OPERATION OF THE COOLING SYSTEM.....	65
11. CLEANING AND MAINTENANCE OF THE DEVICE	66
11.1. Exterior cleaning	66
11.2. Interior cleaning	66
11.3. Cleaning the touch screen	69
12. ADVICE ON HOW TO SAFELY STORE THE DEVICE	70
13. TROUBLESHOOTING	71
13.1. Possible defects.....	71
14. WARRANTY CONDITIONS.....	72
15. RATING PLATES.....	73
16. TECHNICAL DATA	74
16.1. ST, ST BD, CHL devices	74
16.2. ST M, CHL M devices with monoblock.....	75
16.3. ST, CHL multi-chamber devices	76
16.4. ILW devices	79
17. DECLARATIONS OF CONFORMITY.....	80

1. INTENDED USE AND IMPORTANT INFORMATION FOR THE USER





ST thermostatic cabinets, CHL refrigerators and ILW cooled incubators are laboratory devices designed for incubation and storage of samples at following temperature ranges:

- thermostatic cabinets ST: +3°C ... +40°C / +70°C (option, not available for devices with external glass doors)
- laboratory refrigerators CHL: 0°C ... +15°C
- laboratory incubators ILW: -10°C (option) / 0°C... +70°C

Thermostatic cabinets and incubators have both heating and cooling systems and forced air convection. Laboratory refrigerators have only a cooling system. All devices are controlled by a precise SMART controller, thanks to which the set temperature is maintained with good fluctuation and variation. ST thermostatic cabinets and CHL refrigerators are also available in multi-chamber versions, in which each chamber is independently controlled - this manual also applies to devices of this type.

ST thermostatic cabinets are also dedicated devices, among others: for incubating samples for BOD determination using OxiTop manometric sets, etc., in which sample bottles are placed on a mixing platform. The platform is connected to the internal power socket (optional equipment). Depending on the number of BOD determination kits, the cabinets can be equipped with 2, 3 or 4 power sockets. The maximum load on the sockets is 200 W.

The meaning of information symbols

	This symbol means that failure to follow the instructions could endanger people's health or life, or damage the device. The manufacturer is not liable for damages resulting from non-compliance with the instructions contained in the manual.
	A flammable coolant is used in the cooling system. If the cooling system is damaged, ventilate the room carefully and remove all open flames near the unit.
	Warning for devices equipped with UV fluorescent lamps: take special care during work, avoid exposure of the hands and eyes to ultraviolet radiation. This radiation can cause eye damage (conjunctivitis) and skin changes (redness, cancer lesions, etc.). It is recommended not to open the device chamber if UV light is on. The user should be equipped with personal protective equipment (protective gloves, safety glasses).
	This symbol indicates helpful tips.

To guarantee your security and the longevity of the unit, please comply with the following rules:

1.	<p><u>The unit cannot be installed:</u></p> <ul style="list-style-type: none"> • outside, • in damp places or places which can be easily flooded, • near flammable or volatile substances, • near acids or in corrosive environments.
2.	<p><u>It is forbidden to:</u></p> <ul style="list-style-type: none"> • store inflammable or volatile substances inside the unit, • touch live parts of the unit, • operate the unit with wet hands, • put water vessels on the unit, • climb on the unit, • overload the shelves (the maximum load is described in technical data), • place objects on the bottom of the chamber.
3.	<p><u>You should:</u></p> <ul style="list-style-type: none"> • place samples in such a way to provide proper air circulation in the chamber, • open the door for the shortest period of time to reduce temperature fluctuations, • secure samples from being blown out by the chamber fan e.g powdery samples, • always check that the doors are closed correctly,

- use only mains with earth to avoid electric shocks,
- unplug the power cable holding the protective cover and not the cable itself,
- disconnect the unit from the mains before undertaking any repairs or maintenance work (in order to not lose the warranty during its duration, all repairs should be carried out by an authorized service),
- protect the power cable and the plug from any damage,
- disconnect the power plug before moving the unit,
- disconnect the power plug if the device will not be used for a long period of time,
- disconnect the unit and protect it from reconnecting if it has any visual fault.

Failure to comply with the above recommendations may result in damage to the device or deterioration of technical parameters, as well as loss of warranty.

2. PACKAGE CONTENTS

Thermostatic cabinets (ST) and laboratory refrigerators (CHL) in SMART version are delivered with:

Device	ST/CHL									
Capacity	1	2	3	4	5	6	500	700	1200	1450
Shelves [pcs.]	2	2	2	3	3	3	3	3	6	6
Slides [pcs.]	4	4	4	6	6	6	6	6	12	12
Bottom shelves [pcs.]	x	1	1	1	1	1	x	x	x	x
Slides for bottom shelves [pcs.]	x	2	2	2	2	2	x	x	x	x
Power cord [pcs.]	1	1	1	1	1	1	INTEGRATED			
Rubber cap [pcs.]	1	1	1	1	1	1	1	1	1	1
Key for door lock [pcs.]	2	2	2	2	2	2	2	2	4	4
Quality Control Certificate [pcs.]	1	1	1	1	1	1	1	1	1	1

Cooled incubators (ILW) in SMART version are delivered with:

Device	ILW				
Capacity	53	115	240	400	750
Shelves [pcs.]	2	2	3	3	5
Slides [pcs.]	4	4	6	6	10
Power cord [pcs.]	1	1	1	1	1
Rubber cap [pcs.]	1	1	1	1	1
Key for door lock [pcs.]	2	2	2	2	2
Wrench (13mm) for wheels adjustment [pcs.]	x	x	x	1	1
Quality Control Certificate [pcs.]	1	1	1	1	1

3. BEFORE THE FIRST USE

The manufacturer sends the device protected by cardboard profiles and foil. The device **should be transported in an upright position** and the package should be secured against sliding during transport.



After receiving the device, visually assess its condition and equipment in the presence of the person delivering the goods. A courier company is responsible for any damage caused during transport.



While carrying the unit, do not tilt it to one side more than 45° from the upright position, as there is a high probability of damaging the compressor. If it is necessary to tilt it to one side more than 45°, then after placing it, please wait about 3 hours before connecting the unit to the mains.



After transporting the device at a temperature below 10°C, wait at least 2 hours before connecting it to the mains.

On the surface of unit's components made of stainless steel, slight discoloration may occur. It is a result of the technologies used in the production of metal sheet in accordance with the requirements of PN-EN 10088-2 standard and it is not a defect of the unit.

The place of installation of the unit should meet the following conditions:

- ambient temperature +18°C...+28°C, for models with glass door +18°C...+25°C,
- recommended relative humidity of the ambient air up to 60%,
- the unit has not been designed to work in highly dusty environments,
- ensure proper ventilation in the room,
- the device should be placed on a hard and stable surface,
- the unit should be placed at least 100mm away from the walls,
- the height of the room must be at least 300mm greater than the height of the unit,
- the unit is not designed to be built-in,
- the place of installation of the device should be equipped with a socket with parameters suitable for the device.

If you don't comply with the above recommendations, the unit may get broken or it may worsen the technical parameters such as:

- temperature fluctuation,
- temperature variation,
- power consumption,
- icing of evaporator

and may result in loss of warranty.

Wheels / leveling feet



The device has been equipped with wheels or leveling feet. After placing the unit at its destination, secure the device against movement by locking the wheels. In the case of feet, after placing the device in the destination, they should be leveled.

If the unit is equipped with reinforced wheels, they must be locked and leveled. For this purpose use the red knob mounted in the wheel housing. Initially, the knob can be turned by hand, but if resistance is encountered, use a 13 size wrench.

For reinforced wheels with leveling feet (see the image), once the unit is in the desired position, the leveling feet must be unscrewed from all wheels – the unit CAN'T stand on the wheels.

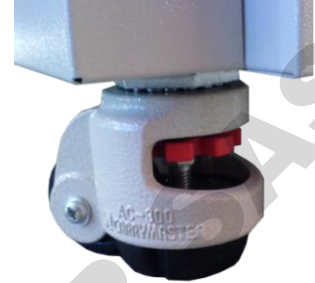

Leveling wheels are **ONLY** for positioning the device at its destination. They can not be used to transport the device!

If the device is to be placed on a table (option) or base (option) which is equipped with wheels with a lock, the wheels **MUST** be locked after placing the table / base in its final destination.

Electric installation



Power supply of the equipment is indicated on a rating plate on the unit. Connect the device to a socket with ground in order to avoid electric shocks in case of the unit's failure.

The installation should be protected by a 16A slow-blow fuse and equipped with a residual current device.

3.1. Installation of shelves

In the ST 1-6, CHL 1-6 models

To install the shelf or to change its position, follow these steps:

Install the shelf slide at the selected height by inserting it into proper slots on the wall of the device. Do the same with the slide on the opposite wall.



Slide the shelf into the installed shelf slides. Now, the shelf is correctly installed!

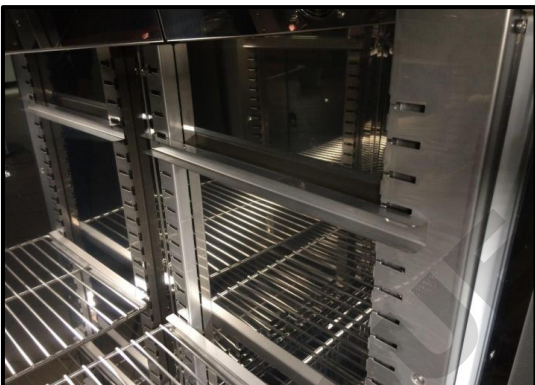

To remove a shelf, perform the above steps in reverse order. To remove the shelf slide from the slots, lift it up and slide it towards the rear of the chamber.

Instruction manual ST, CHL, ILW SMART

In the ST 500 - 1450, ST 500 M - 1450 M, CHL 500 - 1450, CHL 500 M - 1450 M models

To install the shelf or to change its position, follow these steps:

Install the shelf slide at the selected height by inserting it into proper slots on the wall of the device. Do the same with the slide on the opposite wall.



Slide the shelf into the installed shelf slides. Now, the shelf is correctly installed!



To remove a shelf, perform the above steps in reverse order.

In the ILW models

To install the shelf or to change its position, follow these steps:

Install the shelf slide at the selected height by inserting it into perforations on the wall of the device. Do the same with the slide on the opposite wall.



Slide the shelf into the installed shelf slides. Now, the shelf is correctly installed!



To remove a shelf, perform the above steps in reverse order.

3.2. Condensation in the chamber

If the set temperature is much lower than the ambient temperature, condensation may occur, which will cause accumulation of the water at the bottom of the chamber. The amount of accumulated water depends on the following factors:

- the difference between the ambient temperature and the temperature in the chamber,
- frequency of door openings,
- temperature of the samples.

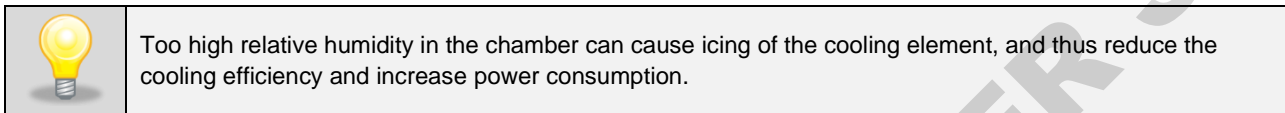
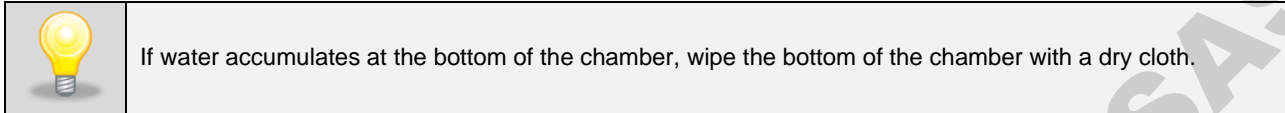

Cartons, sponges and other hygroscopic materials should not be used to store samples, as they may increase the humidity in the chamber.

3.3. Remarks on the placement of samples

To provide proper air circulation and stable conditions in which the samples are stored in the chamber, it is necessary to keep the following rules:

- the max height of the samples should not exceed 1/3 of the space between the shelves,
- approx. 1/3 of the width and depth of the shelf should remain empty, while the distances between the samples, as well as between the samples and the wall should be approximately equal.

The picture below is an example of the placement of samples in the chamber.

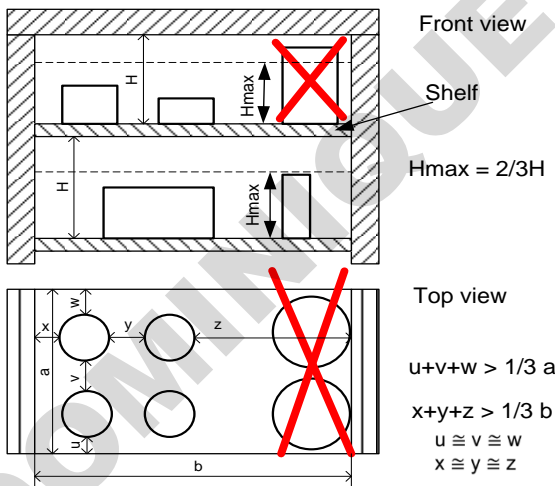

Following the above rules will provide best optimal parameters of temperature fluctuation and variation.

3.4. Closing chamber door

All units have been equipped with a gasket and open door sensor. If the door has not been closed properly, an audible and visual alarm will start. You can set delay door alarm by: 30s, 1 min, 2 min, 5 min or 10 min ([see Section 6.14](#)).

3.5. Anchoring of the equipment



In the case of high equipment (ST 500, ST 500 M, CHL 500, CHL 500 M, ST 700, ST 700 M, CHL 700, CHL 700 M, ST 1200, ST 1200 M, CHL 1200, CHL 1200 M, ST 1450, ST 1450 M, CHL 1450, CHL 1450 M) and multi-chamber units they must be anchored to the wall with suitable fixings (the anchoring kit is supplied with the device). This prevents the unit from falling over. **Lack of anchoring may result in damage to the device and in extreme cases may endanger the health or life of the person who using the device.**

Rear view

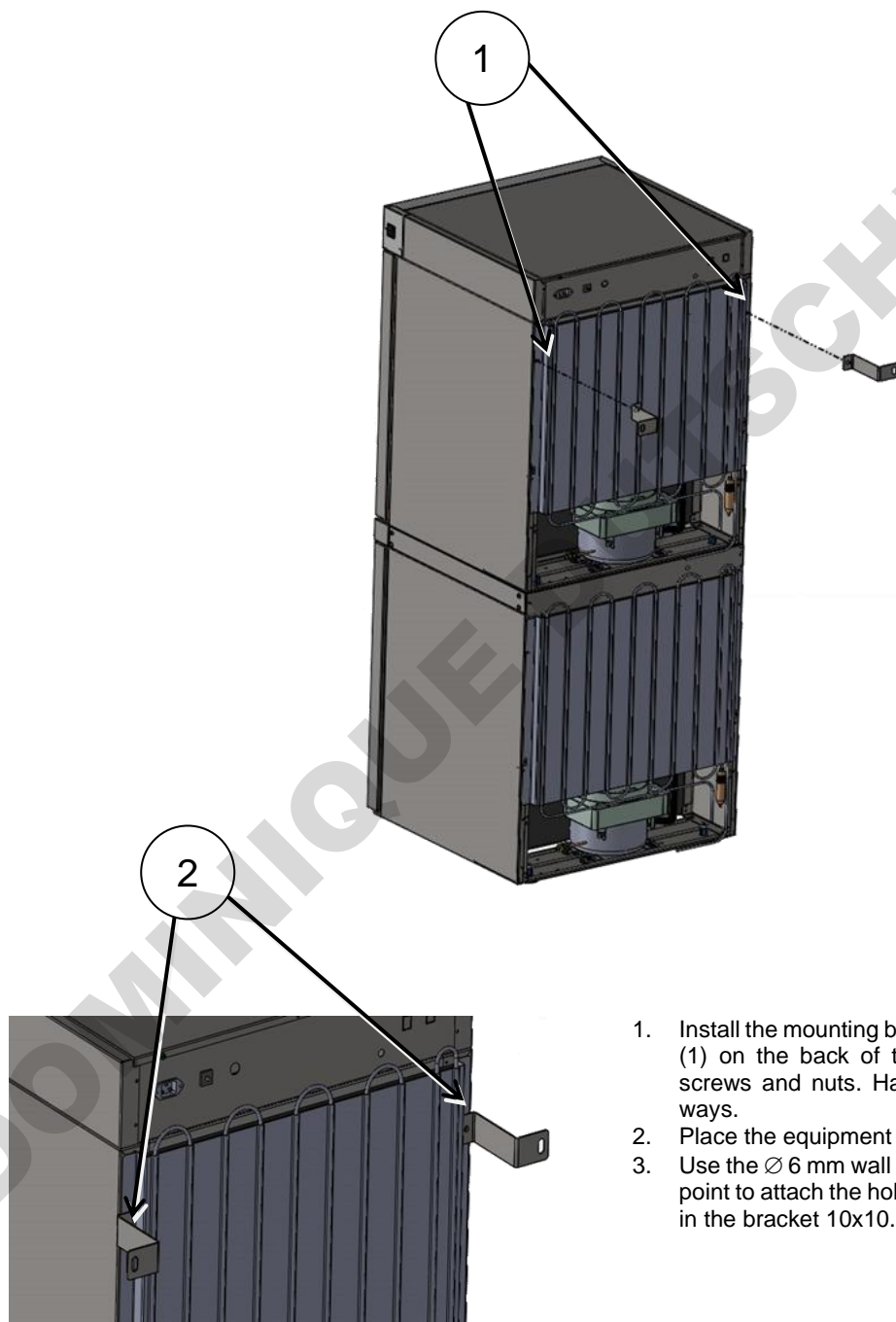

1. Install the mounting brackets (2) to the holes marked (1) on the back of the device using the supplied screws and nuts. Handles can be set up or sideways.
2. Place the equipment at the destination.
3. Use the $\varnothing 6$ mm wall plugs adapted to the anchoring point to attach the holders. Elongated mounting hole in the bracket 10x10.

4. DESCRIPTION OF THE DEVICE

SMART models are equipped with a PID microprocessor temperature controller and a 4.3 inch colour touch screen with a resolution of 800x480.

4.1. Design of ST / CHL devices

Below there's a picture of ST model (exemplary photo) with a description of the important components of the device. CHL model looks identical.

Front view

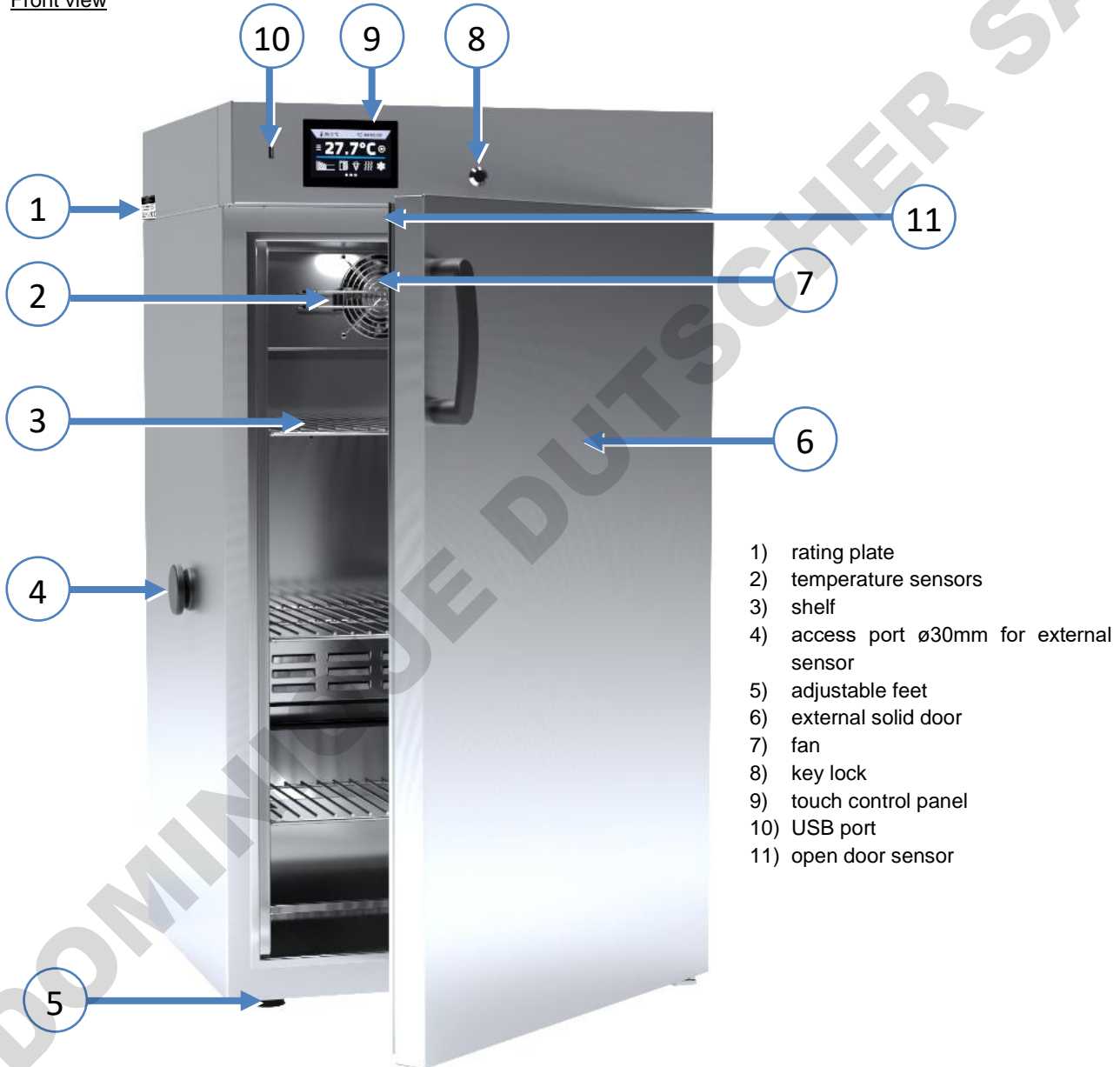

Rear view (ST/CHL 1-6 models)

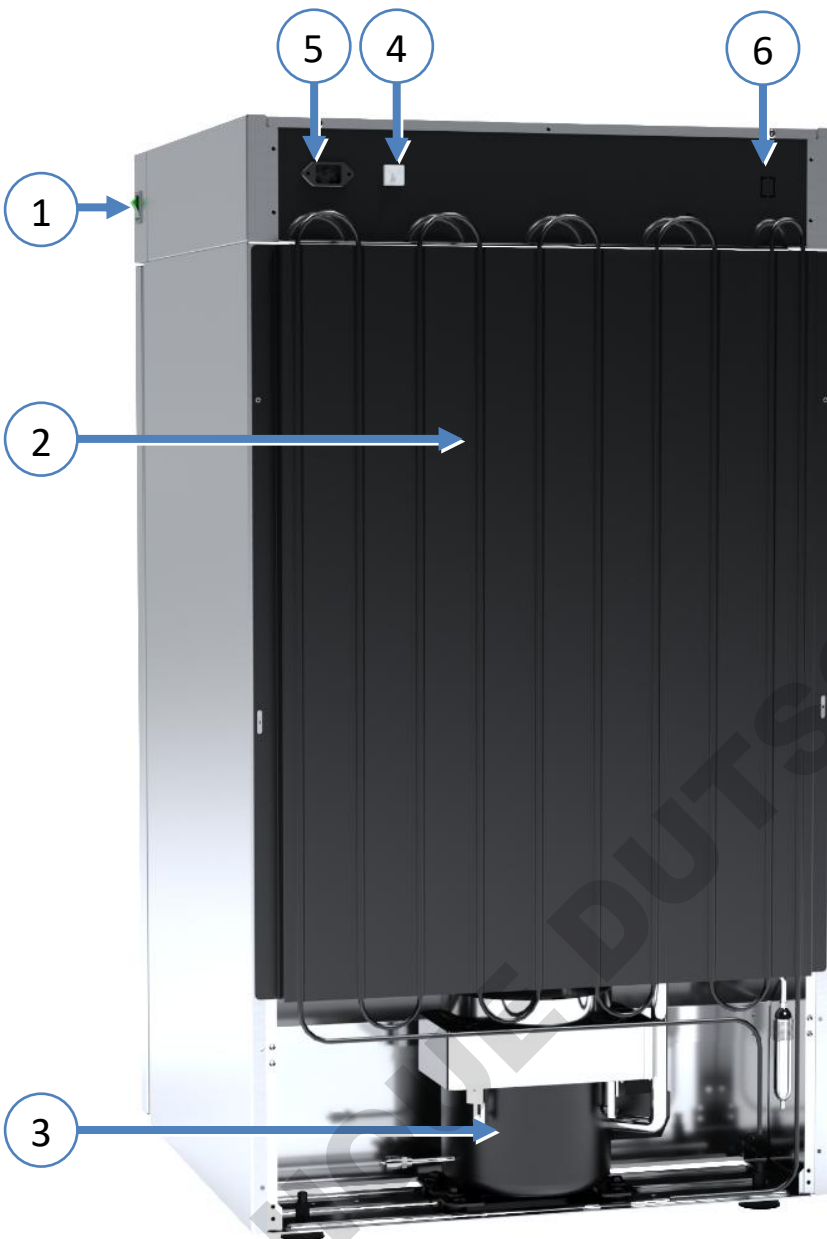

- 1) main switch
- 2) condenser
- 3) cooling system
- 4) fuse
- 5) main power socket c14
- 6) LAN port

Rear view (ST/CHL 500 M - 1450 M models)

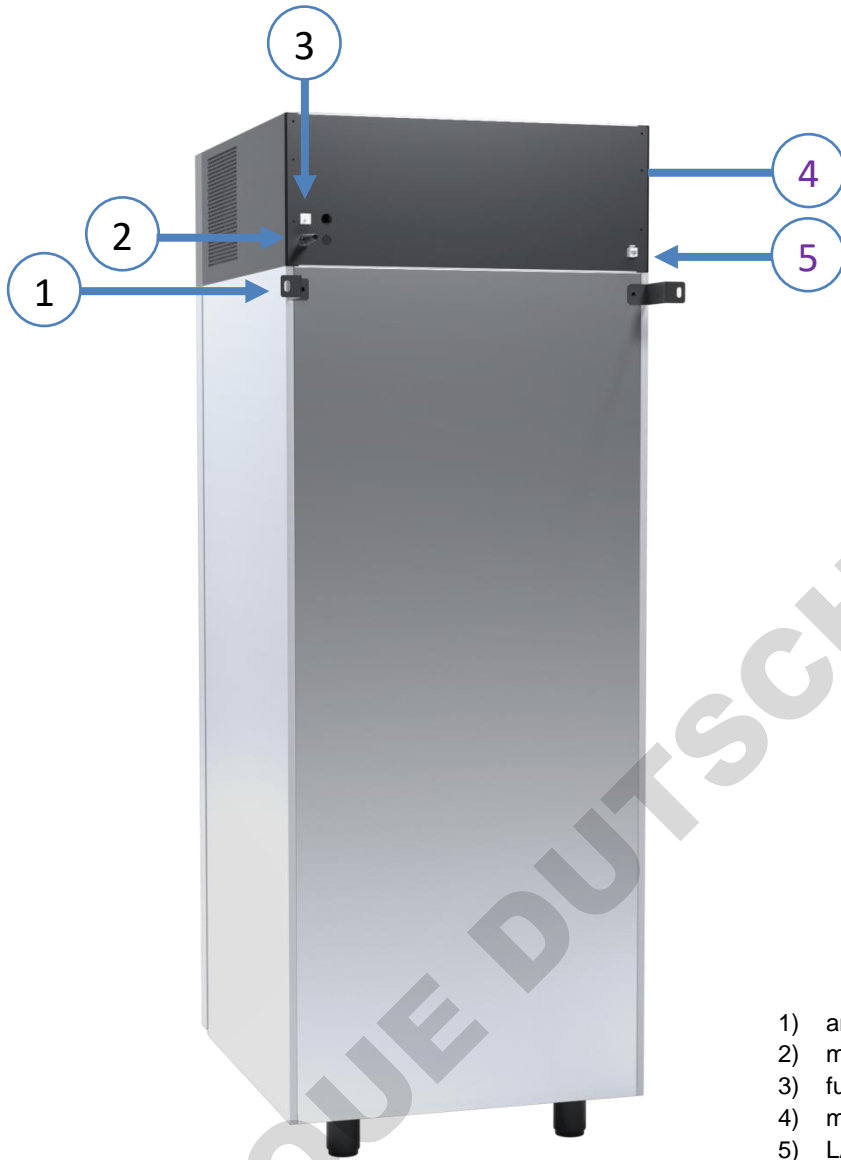

- 1) anchoring handle
- 2) main power socket c14
- 3) fuse
- 4) main switch
- 5) LAN port

4.2. Design of ILW devices

Below there's a picture of ILW 115 model (exemplary photo) with a description of the important components of the device.

Front view



- 1) rating plate
- 2) access port \varnothing 30mm for external sensor
- 3) internal glass door
- 4) shelf
- 5) condenser housing
- 6) external solid door
- 7) temperature sensor
- 8) fan
- 9) open door sensor
- 10) touch control panel
- 11) USB port
- 12) door handle with key lock

Rear view



- 1) main switch
- 2) adjustable feet
- 3) LAN port
- 4) fuse
- 5) main power socket c20

5. DEVICE EQUIPMENT (STANDARD AND OPTIONAL)

5.1. Internal glass door (optionally for ST / CHL, standard for ILW)

Internal glass door is an optional equipment in ST thermostatic cabinets and CHL laboratory refrigerators. For ILW cooled incubators it's a standard equipment. To open and close the door use the plastic handle attached to the glass.



During operation, when the temperature inside the chamber is high, do not touch the internal components and glass door, as there is a risk of burns. Use protective gloves to protect yourself against the effects of burns from hot components.



We do not recommend installing and removing internal glass door. Incorrect assembly or disassembly may result in damage to the glass and injury to the user.

5.2. External glass door (optionally for ST/CHL)

External glass door is an optional equipment in ST thermostatic cabinets and CHL laboratory refrigerators.



It's not possible to purchase temperature extension up to 70°C in thermostatic cabinet ST SMART. The maximum temperature range for ST SMART with external glass door is 40°C.

5.3. External door with viewing window (optionally for ILW)

The external door with a viewing window is an optional equipment for ILW cooled incubators.





During operation, when the temperature inside the chamber is high, do not touch the internal components and glass door, as there is a risk of burns. Use protective gloves to protect yourself against the effects of burns from hot components.

5.4. Drawer on powder-coated slides

Drawers on powder-coated guides are optional equipment for ST thermostat cabinets and CHL laboratory refrigerators. They offer additional functionality and user comfort.

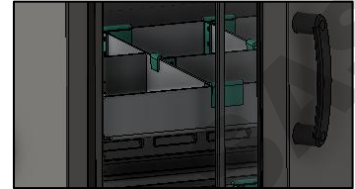

5.4.1. Drawers adjustment

Powder-coated guide drawers can be adjusted, allowing them to be tailored to individual needs. Minor adjustment can prevent undesirable situations, such as accidental drawer extension and potential damage to the materials stored within. To prevent this, one should:

- Pull the drawer out of the chamber.
- Using a 5.5 mm (or 7/32") socket screwdriver, loosen the screws (Fig. 1) located at the bottom of the drawer.
- Set the guides in the desired position.
- After completing the adjustment, tighten the screws.

Figure. 1 drawer adjustment on powder-coated guides.

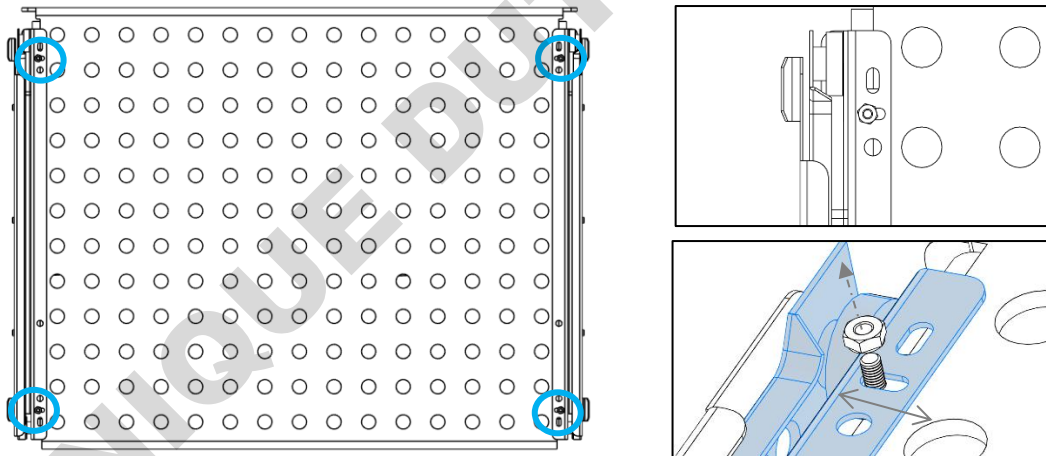

Simple adjustment allows you to customize the drawer to your individual needs, ensuring safety and comfort during operation

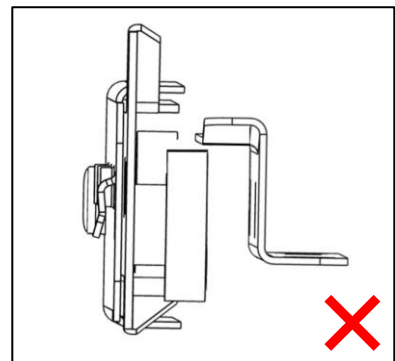
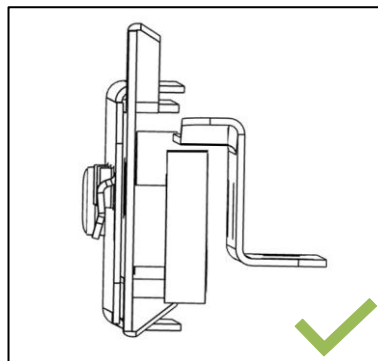
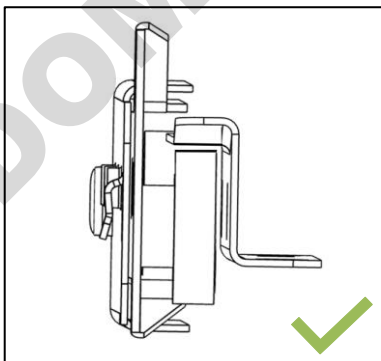

5.5. Internal socket (optionally for ST, CHL, ILW)

An internal power socket with grounding and IP54 protection (IP 66 available on request) is an optional equipment of ST thermostatic cabinets and CHL laboratory refrigerators. Socket versions available: B/E/F/G/I/J. and ILW incubators. The internal power socket (230V, 50Hz) is designed for EU plugs. The socket can be used to connect electrical devices inside the device.

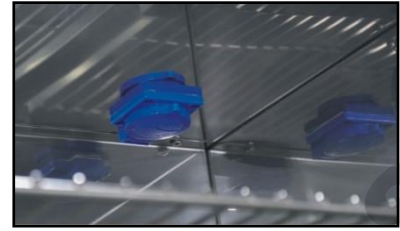

The maximum permissible load of all sockets inside the device (max. 3 pcs.) is 200 [W].



Always make sure that the safety rules for working with electrical devices are followed!

5.6. Door lock (standard in ST, CHL, ILW)

All devices have a key lock. The key lock is situated above the door. Two or four keys are supplied with the device (depending on the model).



5.7. Access port for external sensor (standard for ST, CHL, ILW)

A Ø30 mm access port can be used to insert an external sensor for independent temperature, humidity or other parameter control inside the device. The access port has been secured with a rubber plug. The plug should cover the access port while the unit is operating. If multiple cables have been inserted through the access port and it is not possible to use the plug, secure the access port with adhesive tape. If you leave the access port open, it may affect temperature fluctuation and variation inside the chamber.



5.8. Open door alarm (standard for ST, CHL, ILW)

All units have been equipped with an open door sensor. If you open the door, the icon:  will appear (the number above the icon presents open door counter. Press the icon to cancel the counter. The counter is also cancelled by turning of the device). If the door remains open longer than the time set by the user (30s, 1 min, 2 min, 5 min, 10 min) an acoustic signal, red pulsating alarm bar and „open door” alarm with active status will appear.



5.9. Internal LED light (standard for ST, CHL optionally for ILW)

All ST thermostatic cabinets and CHL laboratory refrigerators are standardly equipped with LED interior lighting, which is integrated with an open door sensor (Philips Corepro LEDspot 3.5-35W GU10 827 36D). When the light turns on, an



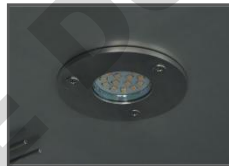

icon will appear on the display . will appear on the display. For devices with external glass door (ST, ST BD, CHL)

or with door with viewing window (ILW), additionally pressing the icon  allows you to turn the LED lighting on or off at any time.



5.10. USB port (standard for ST, CHL, ILW)

The USB port on the front panel is used only to transfer data from the device's internal memory to the flash drive. To do this insert the flash drive into the USB port on the front panel and then:

- go to the main menu ,
- go to the data record ,
- press  and choose type of the file: *.csv, or *.plx.
- press . Data has been copied.



After copying the data to the USB flash drive, before removing it from the USB socket, it should be unmounted by pressing the icon  in the top drop-down list. If the pendrive is not unmounted after connecting to the computer, a message about pendrive damage may be displayed with a repair proposal, when actually the pendrive is not damaged



Figure 2 Unmounting USB flash drive

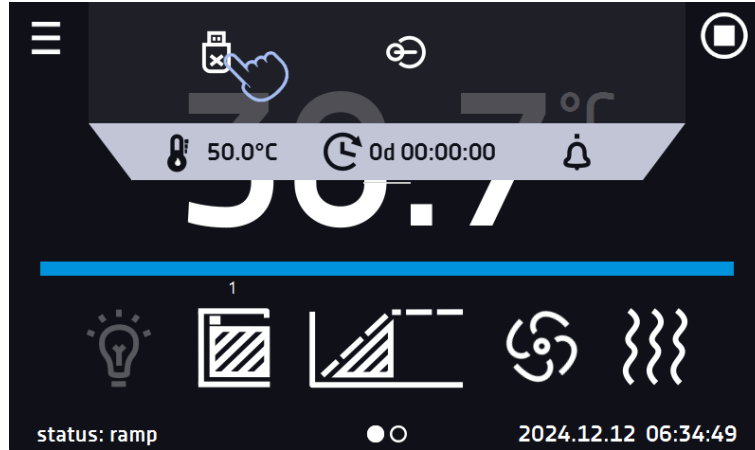

Data saved in the *.csv file can be opened in a spreadsheet. Data saved as *.plx can be opened in the Lab Desk program (additionally paid option). This program allows, among others, for data preview in the form of a table or a graph. It also allows you to prepare a statistic report for a selected range of data, see [Section 6.1](#).

5.11. Photoperiod FOT (optionally for ST and ILW)*

* The FOT photoperiod option is available for all cabinets with a unit, including ST 500, ST 700, ST 1200 and ST 1450 models. The photoperiod option is NOT available for thermostatic cabinets with a monoblock, i.e. ST 500 M, ST 700 M, ST 1200 M and ST 1450 M.

ST thermostatic cabinets and ILW laboratory incubators can be equipped with photoperiod (FOT). Photoperiod allows you to program the duration of lighting for each segment (ON / OFF). Thanks to the photoperiod (FOT) function it is possible to simulate day and night. If a photoperiod is installed in the device, instead of the icon  in the main screen there is an icon  (internal LED light is not installed in devices with a photoperiod).

Programming possibilities for the FOT version, go to the [Section 6.5.9](#).

- day and night simulation – it is possible to program temperature, time and lighting (ON / OFF) for each segment,
- temperature range for „night“: +3...+50°C (ST models), 0...+50°C (ILW models),
- temperature range for „day“: +10...+50°C,

 For devices with a standard (ILW) or optional (ST) temperature range above +50°C, the range will be factory reduced to +50°C.

- standard fluorescent lamps, type 840, mounted in the side walls of the device,
- operation with priority time.

Figure 3 Main screen for devices with photoperiod

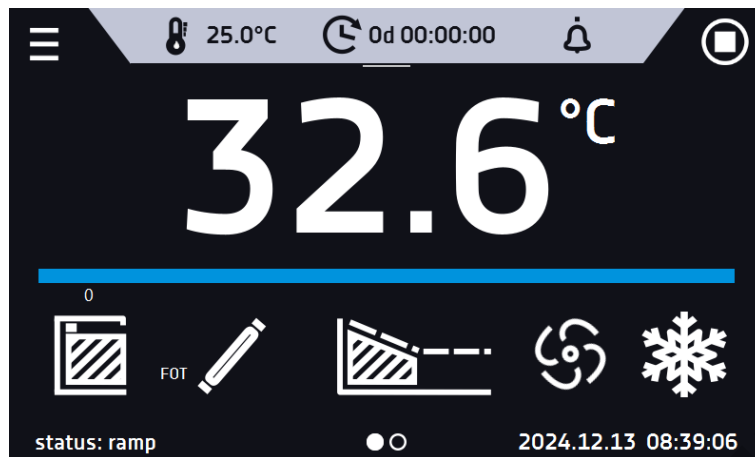

If a photoperiod is not switched on, the icon  is inactive. To program a photoperiod, see the [Section 6.5.9](#).

5.12. Display battery backup (optionally for ST, CHL, ILW)

Units in the SMART version can be optionally equipped with a battery backup of the display. The power loss and switching to the battery backup display mode is signaled by a pulsating red frame around the display and a sound signal (if it is turned on). In the battery backup display mode, all parameters are displayed, ie temperature. Other alarms, e.g. exceeding the temperature range, are also signaled.

In order to extend the battery life, the display is dimmed all the time. Batteries are automatically charged in AC mode.

	Batteries should be replaced every 12 months. When it is time to replace the battery, a message will appear on the display, see . During the warranty period, the replacement should be performed by an authorized service. Otherwise, you will lose your warranty.
---	---

Figure 4 Battery replacement message



5.13. Consumables

Consumables during normal operation are:

- silicone door seal - in all units,
- chamber fan,
- interior lighting bulb - in units with the option of interior lighting.

6. DEVICE OPERATION



This symbol means that a given window can be moved in the direction shown in the picture.

6.1. External memory (USB flash drive)

The external memory (USB flash drive) allows to copy: instruction manual, data record, event log and service log from the device memory. Before first use the USB flash drive should be formatted in the FAT 32 file system. Insert the device in the USB slot on the front of the device next to the display. Wait a few seconds, the correct reading is indicated by the message „USB flashdrive connected” at the bottom of the screen.



After copying the data to the USB flash drive, before removing it from the USB socket, it should be un-mounted (see [Section 5.8](#)).



USB slot is used to connect **only** a flash memory – a pendrive or a card reader with a memory card. Connecting any other device (e.g. external hard drive) without consultation is not authorized by the manufacturer and may damage the USB slot.

6.2. First boot

During the first startup, a wizard appears on the screen allowing you to configure settings such as:

- language selection
- downloading the manual
- connection to a computer network
- setting the time zone and time
- connection to the LabDesk Cloud cloud service

Figure 5 Settings wizard



It is recommended to complete the entire wizard, but you can interrupt it at any time by pressing 

You can then choose one of the options:

- one-time closing – the wizard will be displayed again during the next launch
- check the option so that the wizard will no longer appear the next time you run it
- return to the wizard

Figure 6. Wizard interruption

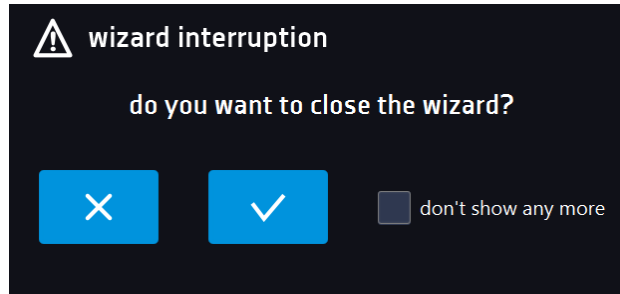



After completing the wizard, a question will appear on the screen about downloading the "Download" folder containing the operating instructions in PDF format to the pendrive. To do this, insert the pendrive into the USB port and wait a moment for the hardware to be detected, then press . If you press  you quit downloading the folder. The window will appear again during the next boot. You can tick „Don't show again” so that the window will not be displayed after switching on the device. You can always download the „Download” folder in the Info submenu. More information [Section 6.11](#).

Figure 7 Downloading files



6.3. Main screen

After switching on the device, the main screen appears. It contains the information about the device status. After starting the program, additional information appears on the screen.

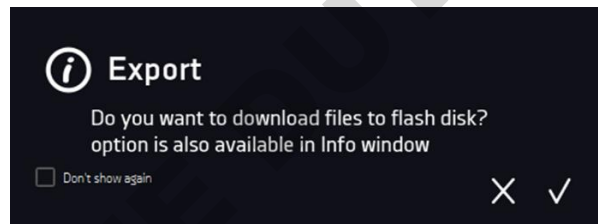
Figure 8. Main screen

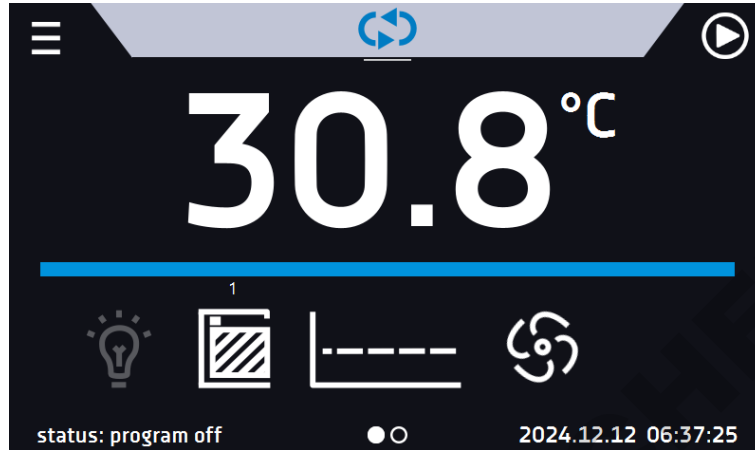

Figure 9. Main screen – running program in ST, CHL

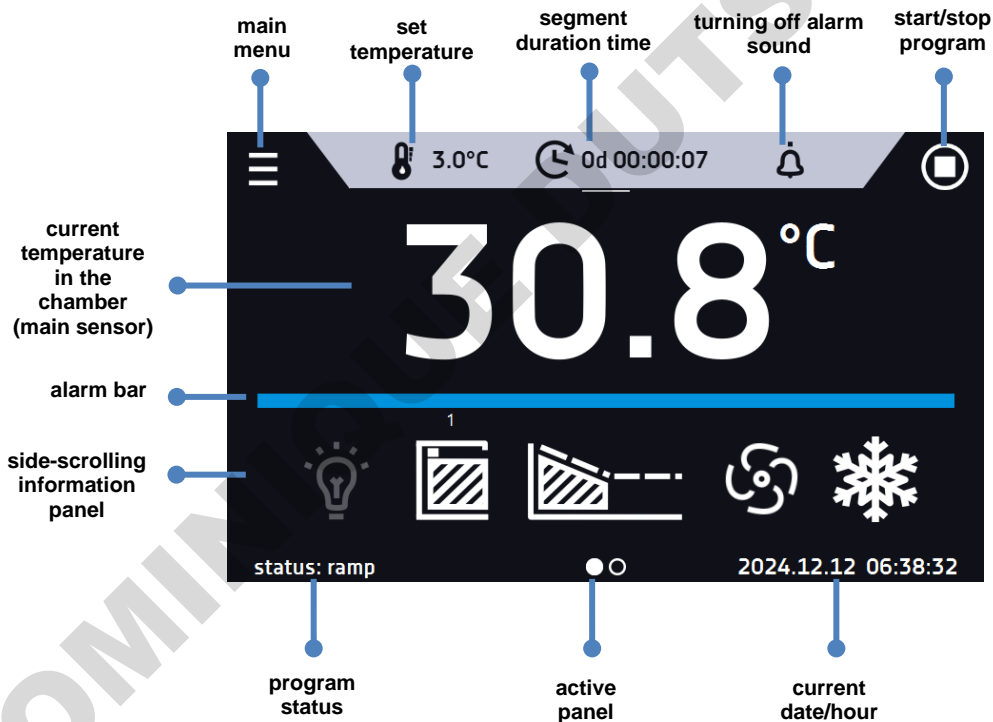
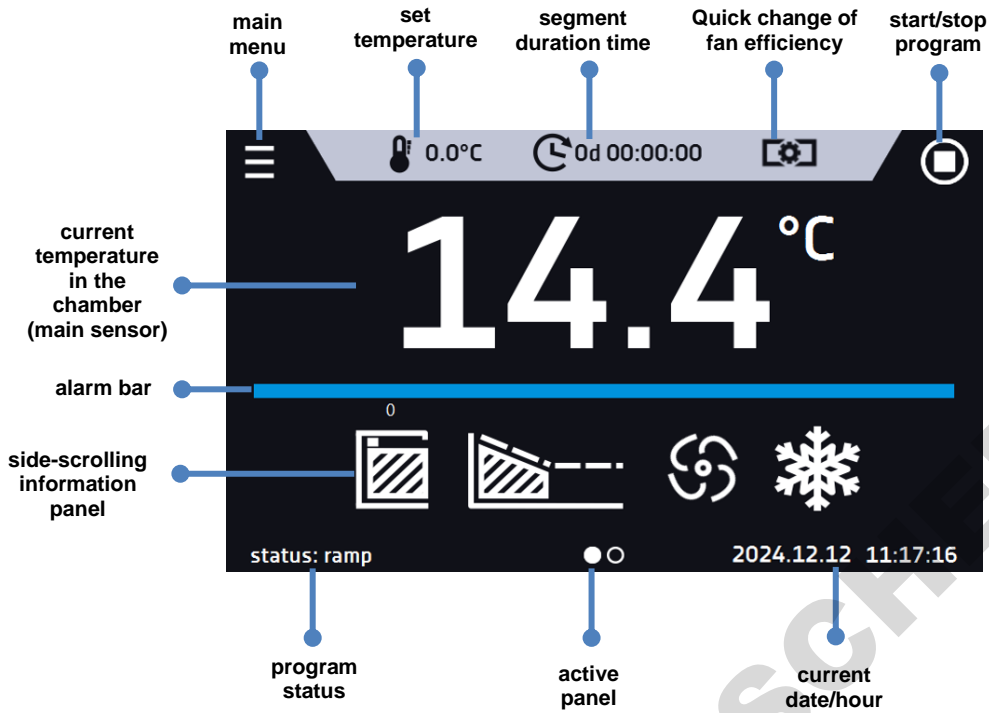
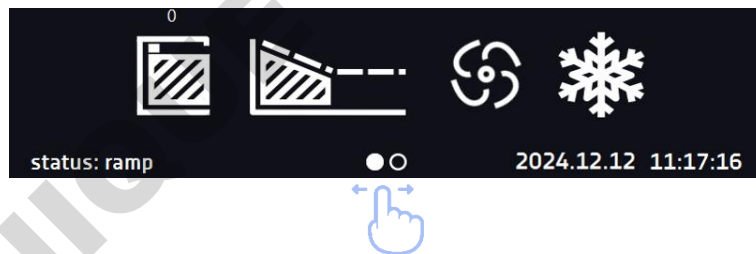

Figure 10. Main screen – running program in ILW



6.3.1. Information panel

There are two different windows in the information panel. Switching between them is done by swiping the finger left or right.



The icon  indicates information about which window is active.

6.3.1.1. Alarms panel

The icon  which is on the second page of the information panel, allows you to go to the alarms panel.

Figure 11. Icon: Alarms panel



In the alarms panel there's a list with active alarms or the alarms that have occurred but have not been confirmed. When the alarm is active, the alarm bar is red and the alarm event is displayed in the list with the status "active". When the alarm event stops, the state changes to "inactive".

- "delete" button – confirms and removes the alarm from the list (only inactive alarms can be deleted),
- "confirm" button – confirms an alarm,
- "details" button – displays a preview of all instances of selected alarm.

Figure 12. Alarms panel

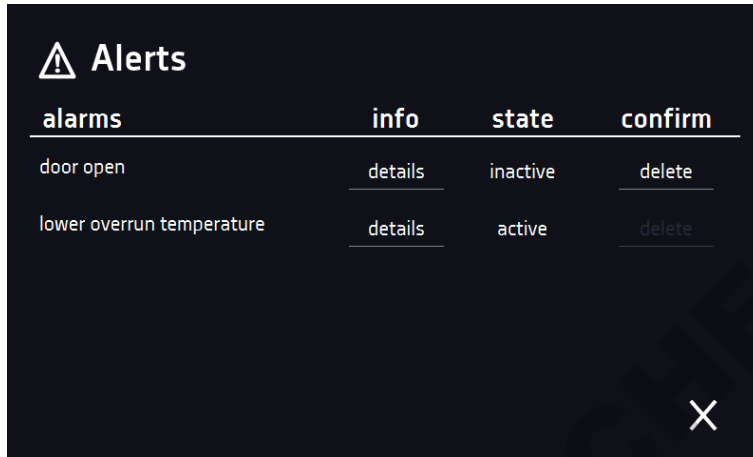
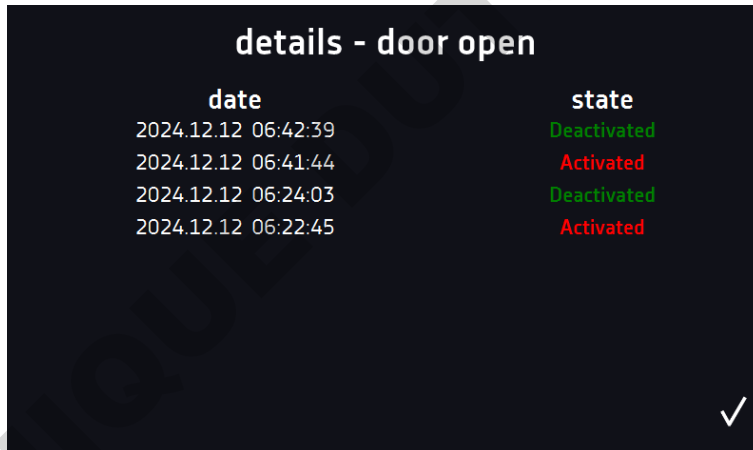

Figure 13. Alarm details



6.3.1.2. Status panel

The icon  which is on the second page of the information panel, allows you to go to the status panel.

Figure 14. Icon: Status panel



The status of the device is indicated also by description.

Figure 15. Status – description

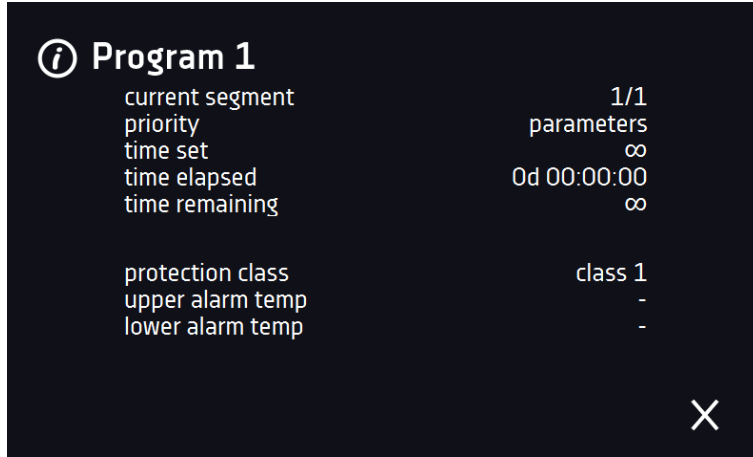





























program name	the name of running program
current segment	currently running segment / total number of segments in the program
priority	of time or parameters
time set	set time of running segment
time elapsed	elapsed time since the segment has started
time remaining	remaining time until the end of the segment
current loop	currently performing cycle/ total number of cycles to perform
protection class over temperature under temperature	information about the protection temperature of a running or completed program. The protection parameters can be set in the program parameters. Information about protection classes
upper alarm temp lower alarm temp	information about set alarms, separately for upper and lower alarm temperature. Setting of the alarms

6.3.2. The meaning of icons and symbols

icon	function
	The icon allows you to go to the main screen.
	Automatic return to the home screen. Factory setting: disabled.
	The icon allows you to go to the main menu.
	Automatic screen lock. Factory setting: disabled.
	Unmounting the USB flash drive before removing it from the USB socket.
	Internal light is switched on. It's automatically turned on when the door is opened and turned off when it is closed. By clicking the icon on the status panel you can manually turn on / off the light (applies to devices with external glass door or door with viewing window). The icon does not appear in the models with photoperiod where the interior LED light in the ceiling is not installed.
	The FOT light icon (optional for ST, ILW) symbolizes turned on photoperiod, the lighting of the chamber, controlled from the program. Does not apply to equipment with a monoblock (ST 500 M, ST 700 M, ST 1200 M, ST 1450 M).

Instruction manual ST, CHL, ILW SMART

	Icon is visible only when the chamber is cooling down.
	Fan icon. Rotating icon shows that the fan is running. Quick Change function - clicking the icon allows you to change the fan efficiency (without editing the program) in the range of 10% ... 100% (it's a standard equipment for ILW, not available for ST and CHL).
	Icon is visible only when the chamber is heating up.
	Icon is visible only when the automatic defrosting function or defrosting program is running.
	Available when the program is running Clicking the icon allows you to quickly change the set temperature (Quick Change function).
	When the program is running, click the icon to quickly change the time of program duration (Quick Change function). Indicates the time that has elapsed from the program start.
	Countdown of the time remaining to the end of the program.
	Going to alarms panel.
	Going to the status panel with information about the program parameters.
	Going to the menu to create, edit, delete and start programs.
	Turning off of the alarm sound (open door alarm, exceeding temperature range). Critical alarms (i.e. damage to the temperature sensor, temperature protection, etc.) continue emitting a sound.
	Closed door, open door. The number above the icon presents open door counter. Press the icon to cancel the counter. The counter is also cancelled by turning of the device.
	The arrow icon allows navigation between: segments, program parameters and summary.
	Ramp status: Chamber is currently heating up or cooling down.
	Set temperature is reached.
	The program will start on the given date / time. Start delay activated.
	Starting the selected program. In the list of programs - the program is running.
	Stopping the program.

	Adding a new program to the program list. The user can create up to 5 programs.
	Editing the selected program from the list. In the program list, a new program has been created but not approved yet.
	Removing selected program from the list.
	Canceling adding or editing of the program. Canceling changes.
	Editing individual program segments (the program can have max. 6 segments).
	Immediate start of the program selected from the program list.
	Delayed start of the program from the list of programs. The program starts according to the set date and time.
	Going to the SMART program (Quick Program function).
	When the program is running, click the icon to quickly change the fan speed in ILW (Quick Change function).
	Active STM function (Smart Temperature Monitor) informs the user about the problem of reaching or maintaining the set temperature. <ul style="list-style-type: none"> • white color - option enabled, the program is stopped • blue color - option enabled, the program is running red color - warning about problems with reaching / maintaining the temperature

6.3.3. Upper expandable and configurable menu

When the program is running, in the upper part of the main screen there's a bar menu with parameter icons (temperature, time, mute function and fan speed for ILW). These parameters can be quickly changed (Quick Change).

Depending on the model, after swiping your finger down you will see icons for all parameters which can be quickly changed (see [Section 6.7](#)). Among the options available in the bar you will find the following icons:





-  USB flash drive unmounting – more information [Section 5.8](#).
-  mute option. Critical alarms (i.e. damage to the temperature sensor, temperature protection, etc.) continue emitting a sound, see [Section 6.14.1](#).
- Quick Change (more information » [Section 6.7](#).) of:
 -  program duration time,
 -  set temperature,
 -  fan efficiency (only for ILW).

Figure 16. Upper menu for ST and CHL



Figure 17. Upper expandable menu for ILW

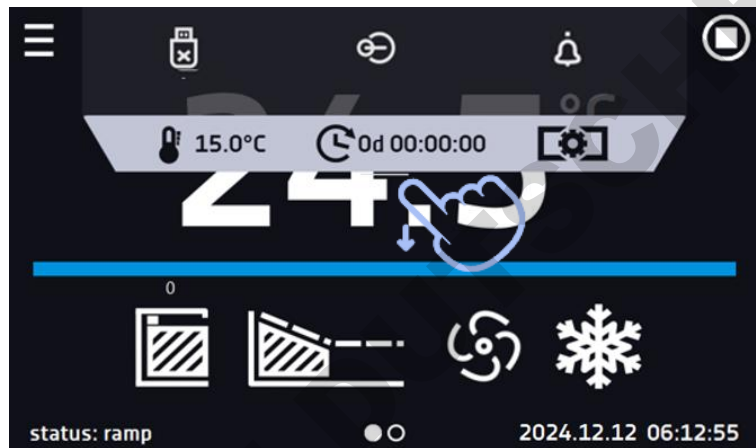
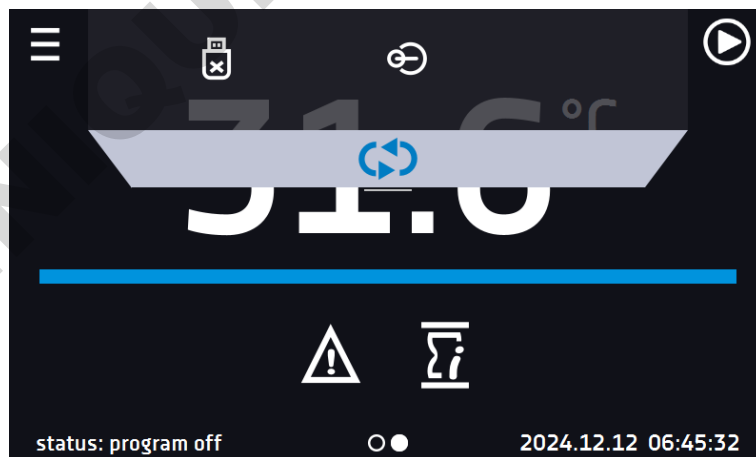

Figure 18. Upper menu when the program is stopped





Positions available on the upper bar can be personalized. Just drag the selected icon to a new location.

Figure 19. Changing icon's position



6.3.4. Alarm bar

The Alarm bar is a quick visual information about the device status. The colour of the bar indicates the status of the device:

-  – blue - the device is working properly
-  – red bar and pulsating frame – active alarm

6.4. Quick program

Quick program allows you to quickly start the program from the main screen position without having to enter to the menu



The Quick program has several features that guarantee its uninterrupted operation:

- you can not set the duration of the program - time is always set to infinity,
- if the display fails, the program continues,
- after the power supply is resumed (after its failure), the program continues,
- to prevent the program from stopping accidentally, the STOP button was removed from the main screen.

Figure 20. SMART program

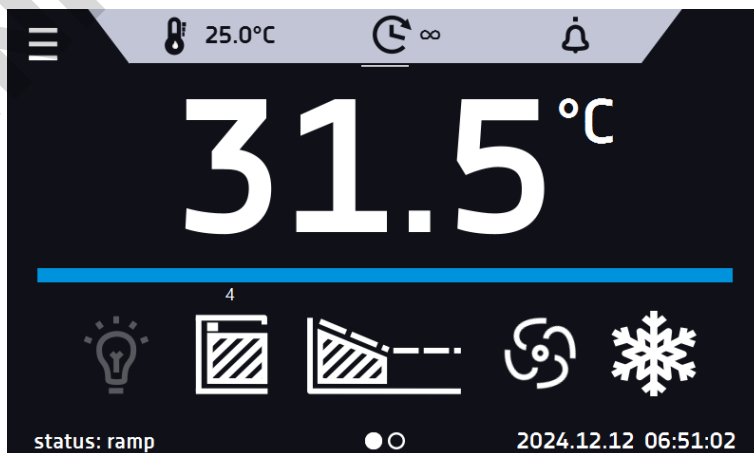

In order to go to Quick program click the icon  in the main screen. By clicking the appropriate icon you can set:

-  temperature,
-  fan (only for ILW).

Clicking the icon  starts the program in continuous mode (time set to infinity).

Figure 21 Starting the Quick Program



Stopping a Quick program has been made difficult on purpose (this prevents the program from being stopped accidentally) – to stop a program, you have to:

1. go to the menu ,
2. click the program window ,
3. keep pressing STOP button  for 5 seconds.

The over and under temperature protections are set automatically: the over temperature protection is the set temperature + 10°C, the under temperature protection is the set temperature -10°C.

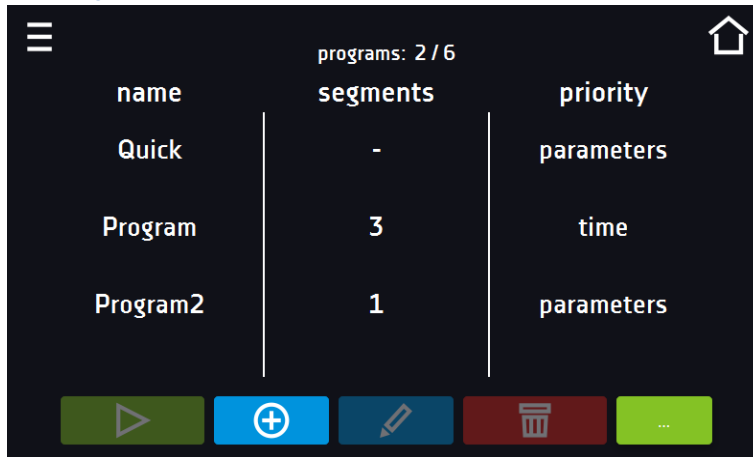

After configuration of the Quick Program, it appears in the programs list. Quick Program is displayed at the top of the list by default.

Figure 22 Quick program on programs list



In Quick Program editing mode, you can change:

- settings of the data recording interval,
- settings of the protection class.

When the program is running you can change the parameters (temperature, fan) by pressing the icon  or  (for ILW). During next launch of the Quick program, your previous settings will be remembered.

6.5. Programs

Press the icon of main menu , and then press . In this panel you can run the selected program, add a new one, edit the program or delete it. The user can create 5 independent programs.

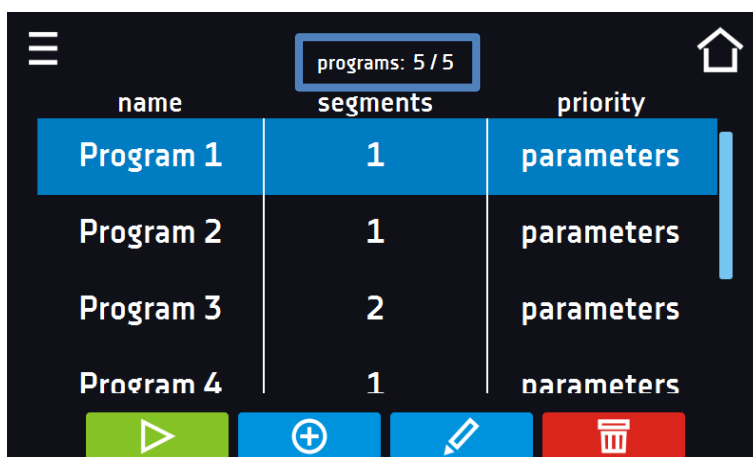

-  Start the selected program.
-  Stop the program.
-  Add a new program.
-  Edit the selected program.
-  Delete the selected program.

Figure 23 List of programs



Information on the number of created programs / the maximum number of programs that can be created is at the top of the screen (programs: 5/5).

6.5.1. Creating / editing a program

Press the button  or  and a panel with program parameters will appear.

The program name is given automatically and it can't be changed. In this panel you can set:

- **Segments number** – max. 6 segments
- **Interval** – frequency of saving the data in the data record (1 min, 2 min, 5 min, 10 min, 15 min, 30 min, 1 h),
- **Protection class** – more information [Section 6.5.4.](#)
- **Temperature protection** – temperature range for the protection class, more information [Section 6.5.5.](#)
- **Priority** – the priority of time or parameters, more information [Section 6.5.6.](#)
- **Loop** – the number of program repetitions, more information [Section 6.5.7.](#)

Figure 24 Program parameters

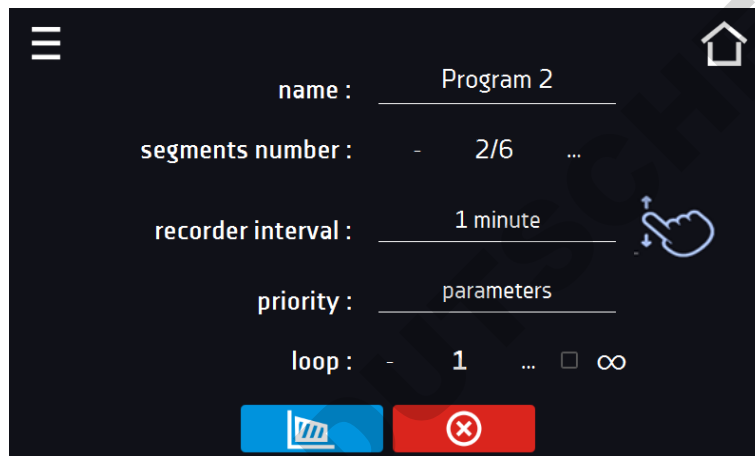

Cancels adding or editing of the program.



Going to the edition of program segments.



With more parameters, the window can be scrolled up and down.

6.5.2. Segments edition

For each of the 5 programs, you can set maximum 6-segment time-temperature profiles that allow you to gradually increase or decrease the incubation temperature of the samples. This can e.g. protect the sample from so-called thermal shock. Example of program operation with programmed segments (parameters priority):

Program 1

- segment1: temp. 30°C, time 2 hours (after reaching the temperature 30°C, it is maintained for 2 hours)
- segment2: temp. 40°C, time 3 hours (after reaching the temperature 40°C, it is maintained for 3 hours)
- segment3: temp. 50°C, time 3 hours (after reaching the temperature 50°C, it is maintained for 3 hours)
- segment4: temp. 40°C, time 2 hours (after reaching the temperature 40°C, it is maintained for 2 hours)
- segment5: temp. 30°C, time 2 hours (after reaching the temperature 30°C, it is maintained for 2 hours)
- segment6: temp. 20°C, time 1 hours (after reaching the temperature 20°C, it is maintained for 1 hour)

Press the button  and the first program segment will appear.

In this window you can set:

- **temperature** – target temperature which the device is to achieve in this segment (needs to be minimum 2°C below the value for over temperature protection and minimum 2°C above the value for under temperature protection),
- **time** – the time of maintaining the set temperature ([d hh:mm]) in days, hours and minutes. It is possible to select continuous work ∞ in the last segment,
- **ramp time** – the time of reaching the set temperature ([d hh:mm]) in days, hours, minutes.

The following parameters are available in selected models or as additional paid options:

- **fan** - fan efficiency in percent (ILW),
- **fan ramp** – fan efficiency when reaching the set temperature (ILW),
- **light** – setting the FOT light in the segment (optionally for ST and ILW, not available for units with monoblock).

The active value is highlighted in blue. The item highlighted in red means that the value is out of range and you should enter another one, e.g. the temperature is above / below the operating range of the device or the protection temperature.



The fan efficiency set to 100% is the default value. Reducing the fan efficiency may cause improper operation of the device, e.g. chamber icing, worse fluctuation and variation of temperature, excessive condensation of water.

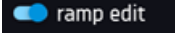

Ramp time - setting a short time will not accelerate reaching the ramp, but the ramp will be reached in the shortest possible time depending on the set temperature, ambient conditions and the possibilities of the cooling or heating system in the device.

The ramp parameters are factory set in accordance with the manufacturer's instructions. If it is necessary to set individual parameters when reaching the segment temperature, activate the ramp edition field  and set your own values.



With more parameters, the window can be scrolled up and down.

Figure 25 Program segment edition

<
segment 1/2
>

temperature [°C] 3.0

time [d hh:mm] 0 05 : 00

ramp edit

time [d hh:mm] 0 01 : 00

7	8	9
4	5	6
1	2	3
.	0	+/-

X
∞



The navigation between: segments, program parameters and summary is done by touching the icon



If, when editing a program, you automatically return to the home screen, the edited program will not be lost, but saved as a draft (see below).

After configuring all segments, a window with the security class is displayed, For class 2.0, 3.2 (option) and 3.3 (option), the protection temperature can be set.

Figure 26. Program protection

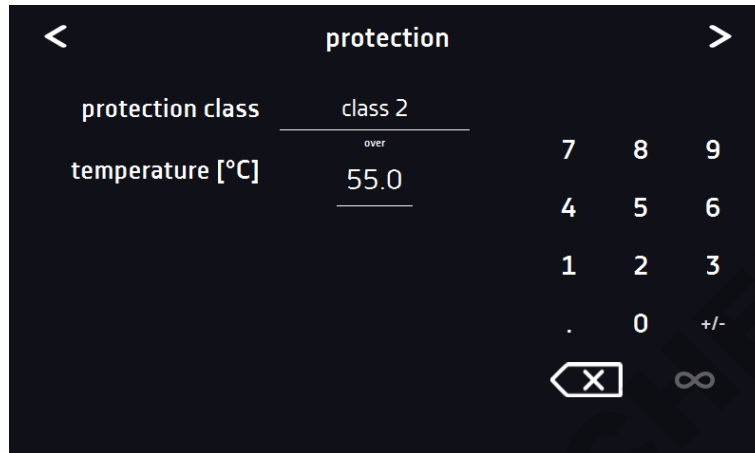

After switching to the program edition, the information about the possibility of continuing changes in the program settings appears.

Figure 27 Info

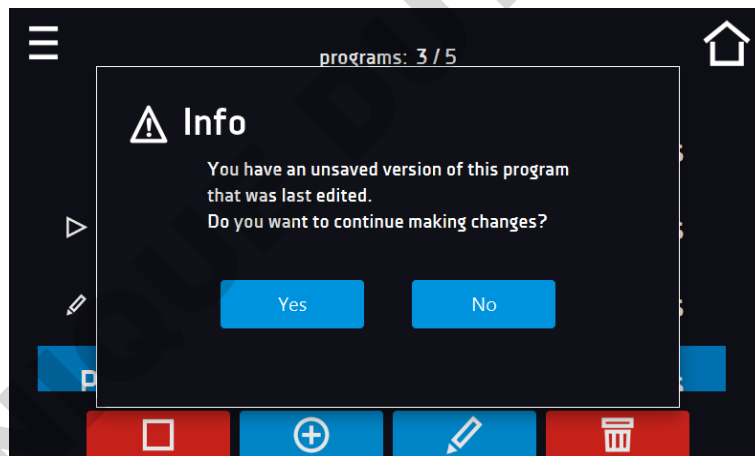

6.5.3. Summary of segments

In the segments summary all segments can be seen along with introduced parameters:

- number of segments,
- temperature, duration time, target time of reaching temperature of a given segment (ramp),
- fan efficiency (ILW).

Figure 28 The summary of the segment

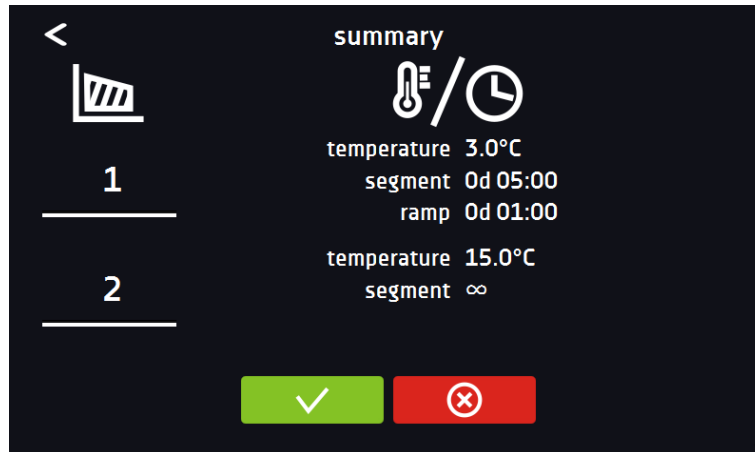

Confirms and saves the changes.



Cancels the entered changes in the segments and goes to program parameters.

6.5.4. Protection class

The device is equipped with sample protection – temperature protection which is carried out on the basis of the temperature value measured by an independent temperature sensor, the so-called security sensor. The main aim of sample protection is the protection against uncontrolled rise or fall of temperature. When activated, the relay disconnects the heating / cooling circuit.

Figure 29 Confirmation of protection alarm class 2.0

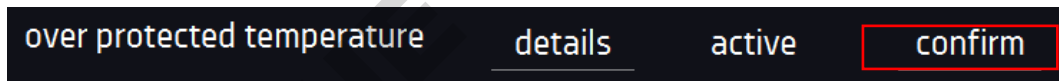

There are five classes of sample protection:

Class 1.0 according to DIN 12880 – the protection is set at + 10°C above the maximum temperature that the device can maintain (standard for ST and CHL).

Class 2.0 according to DIN 12880 – the user programs the protection temperature and once it's exceeded, the heaters are cut off. To restart the device, the user must turn the device off and on (standard for ILW).

Class 3.2 according to DIN 12880 – the user programs the protection temperature and once it's exceeded, the compressor is cut off. When the temperature returns to the allowed range, the device resumes operation (option for ST and CHL).

Class 3.3 according to DIN 12880 – over and under temperature protection – combination of classes 3.1 and 3.2. - the user programs temperature protection (over and under) and once it's exceeded, the heaters or compressor will be cut off. When the temperature returns to the allowed range, the device resumes operation (option for ILW).

The set temperature in the segment cannot be higher than the over temperature protection minus 2°C, e.g. the over temperature protection is 50°C, therefore the maximum set temperature in the segment that can be set is 48°C.

6.5.5. Temperature protection (option)

The temperature protection value for protection class 3.1 and higher is:

- lower temperature protection: maximum +20°C
- upper temperature protection: minimum + 30°C

6.5.6. Priority

Can be set in terms of:

Parameters:

In the program without ramp – the device starts the countdown of the segment time when the set temperature is reached.

In the program with ramp – first, the device counts down the time of the ramp and then proceeds to the segment countdown when the set temperature is reached. Regardless of whether the time of ramp elapsed.



It may happen that the device failed to reach the set temperature within the set time because the reaching time was too short. In such situation the reaching time will be prolonged and the segment's time countdown will start when the set temperature will be reached.

Time:

In the program without ramp – the device starts counting down the segment time when the program is started. Regardless of whether the temperature has been reached.

In the program with ramp – first, the device counts down the ramp time and after its expiry it proceeds to the countdown of the segment time. Regardless of whether the temperature has been reached.



It may happen that the time of reaching was too short and the device failed to reach the set temperature within the set time. Then the countdown of the segment time will start before reaching the set temperature. Thus, the actual time of device operating in the set temperature will be shortened.

6.5.7. Loop

The option is available if the number of segments is equal to 2 or more. When the program finishes the last segment, the device starts the program again from the first segment. You can define if the program should be carried out once (loop: 1) or multiple times (loop: 2 to 255). In order to set the program to be carried out continuously, tick the „∞“ option. If the time of the last segment is set to infinity, it will be treated as infinite only in the last cycle. In other cycles it will be treated as 0.

Example:

Loop:3

segment1: temp. 10°C, time 2 h

segment2: temp. 30°C, time 2 h,

segment3: temp. 40°C, time „∞“

The device will run segment1 and segment2 three times and then will go to segment3 which will last indefinitely.

6.5.8. Defrosting program (only for CHL 1-6, CHL 500, CHL 700, CHL 1200, CHL 1450)^{1,2}

¹ does not apply to refrigerators with monoblock: CHL 500 M, CHL 700 M, CHL 1200 M, CHL 1450 M

² does not apply to refrigerators with automatic defrosting function (PLUS function)

CHL laboratory refrigerators (without PLUS - automatic defrosting function) have a special defrosting program. It appears on the programs list available in the main screen after pressing the button . Defrosting is the temporary activation of heaters, which are intended to defrost a coating of ice or frost accumulated on the walls of the chamber during normal use. During defrosting inside the chamber, the temperature rises to around + 30°C and the process lasts 30 minutes.

If the defrosting function is active, you will see the icon  on the main screen. You can stop defrosting at any time by pressing the button .

In ST thermostatic cabinets and ILW cooled incubators in which the sample is stored at a temperature of $\leq 5^{\circ}\text{C}$, ice or frost on the evaporator can be thawed by raising the temperature in the chamber to approx. + 30°C and keeping it for 30 min (you can create a program with the given parameters, which will be visible on the program list and run it if it's necessary to defrost).



When the defrosting has finished, you need to wipe out the chamber. This will reduce the risk of quick frosting of the chamber.

Figure 30 Defrosting program

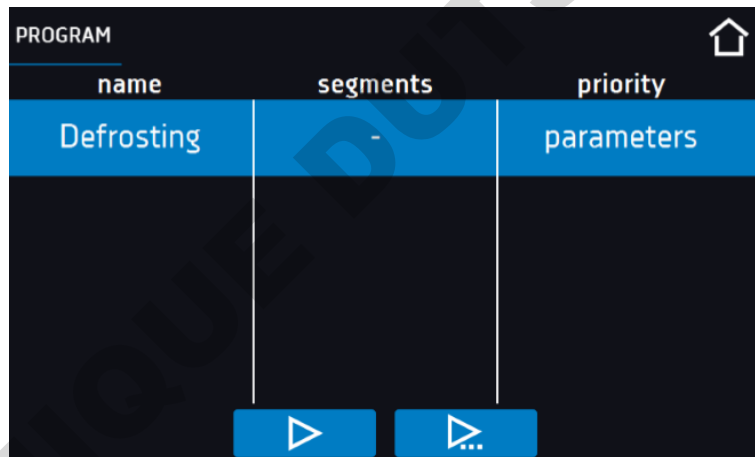

6.5.9. Photoperiod FOT programming (optionally for ST and ILW)

* does not apply to refrigerators with monoblock: (ST 500 M, ST 700 M, ST 1200 M, ST 1450 M).

To program photoperiod you must be in a segment edit mode ([Section 6.5.2](#)) and set the desired temperature, time for which the fluorescent lamps will be switched on, and then select the "light" option. In each of the 6 segments you can turn on or off the light and set its lighting time.

Example

To simulate day and night you should:

- select the number of segments: 2 while creating / editing a program:
- press  and go to the segment 1 edition
- set the "day" temperature, e.g. 25°C
- set the "day" time, e.g. 14 h





- turn on the light
- press  to go to the second segment edition
- set the “night” temperature, e.g. 10°C
- set the “night” time, e.g. 10 h
- don't turn on the light
- press  and go to the segments summary
- click  to confirm and save changes
- click  to cancel introduced changes in the segments and go to program parameters

Figure 31 Turning on / off the photoperiod



6.6. Starting the program

The created program can be started in two ways:

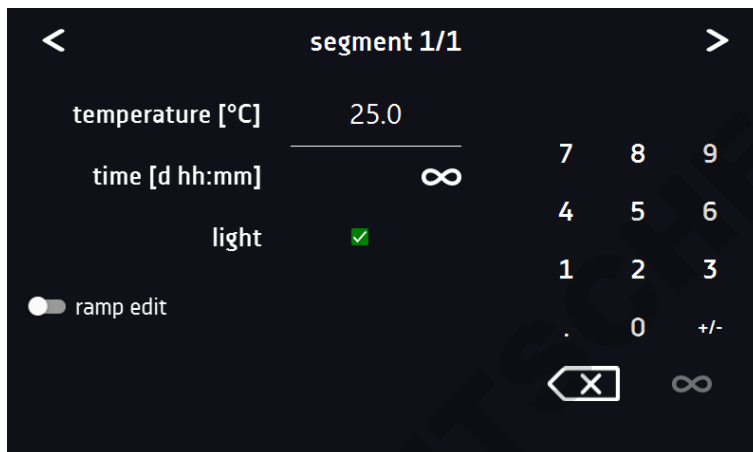
6.6.1. The first way



- Go to the main menu  and press the icon „programs” .
- Then select the program you want to activate and press „start” button .

Figure 32 Main menu

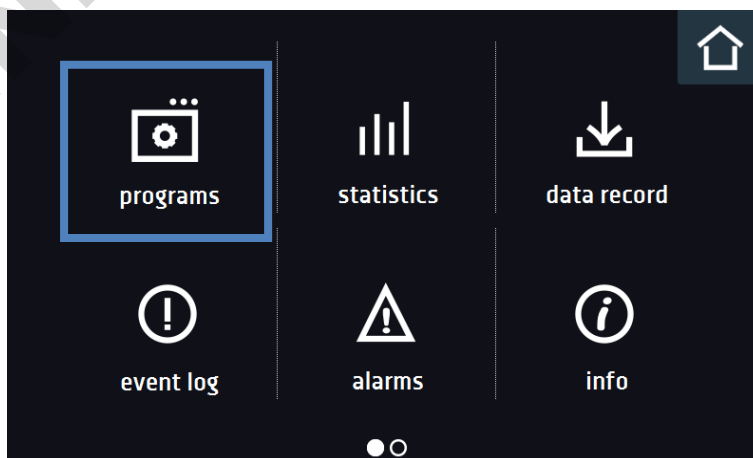
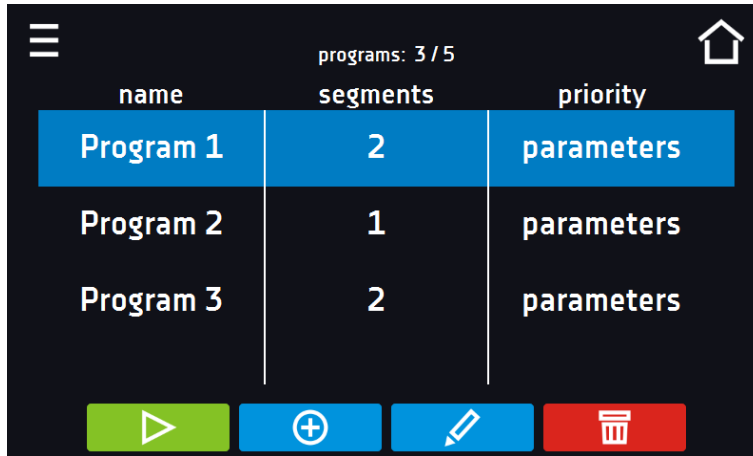

Figure 33 Program management menu







If the program is running, the symbol  appears next to the program name on the list. The symbol  means that the program has been edited, but the changes have not been confirmed.

Figure 34 List of programs with the selected status

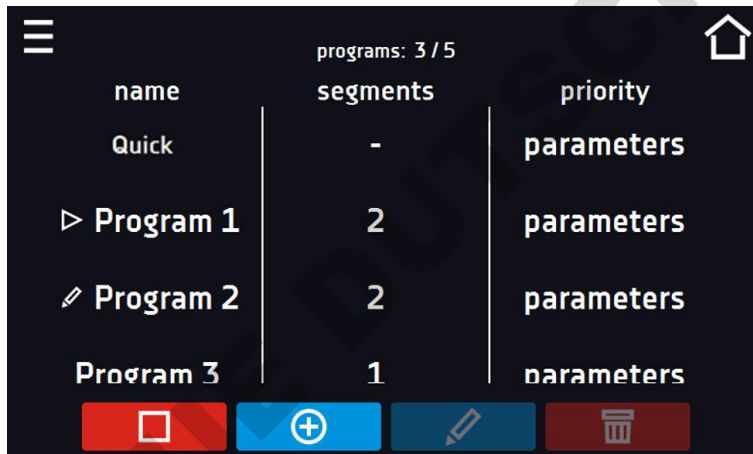

6.6.2. The second way

- In the main screen press the icon in the upper right corner .
- Select the program you want to start. You have two additional options to start the program:



Immediate start of the program.



Scheduled program start according to the set date and time.

Figure 35 Main screen

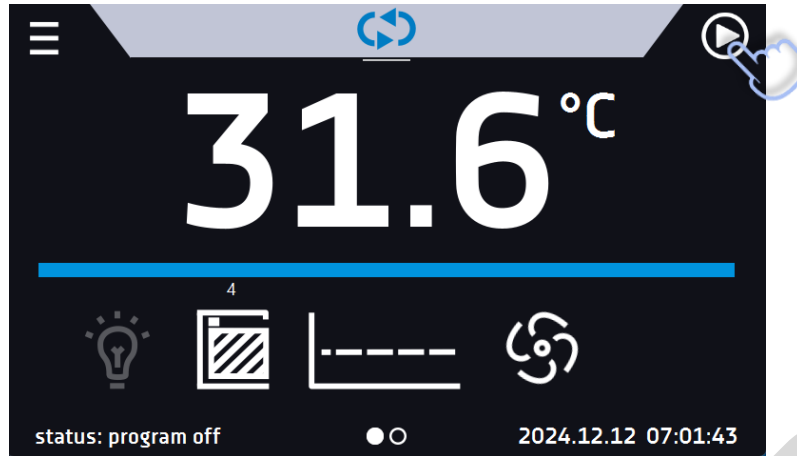



Figure 36 List of programs

PROGRAM		
name	segments	priority
Program 1	2	parameters
Program 2	1	parameters

 It is possible to delay the program start (up to a maximum of 7 days).. This is possible for the programs with time priority. Program segments that would last from the back date to the current date will be skipped.

If the program is running, the symbol  appears next to the program name on the list.

6.7. Quick Change of parameters

 Although the ramp time has been included in the program, the Quick Change of parameters will take place immediately while the temperature is being reached.

6.7.1. Quick change of set temperature



In order to quickly change the value of set temperature of a running program, press the icon  in the main screen. The value of the temperature should be selected by scrolling the list up or down. Click  to confirm the change. **The temperature can't be higher than the over temperature protection -2°C and lower than the under temperature protection +2°C.**

Figure 37 Quick change of set temperature - selection

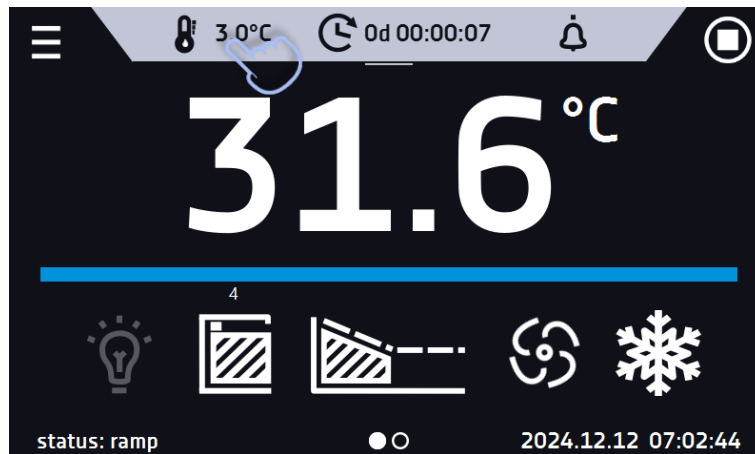
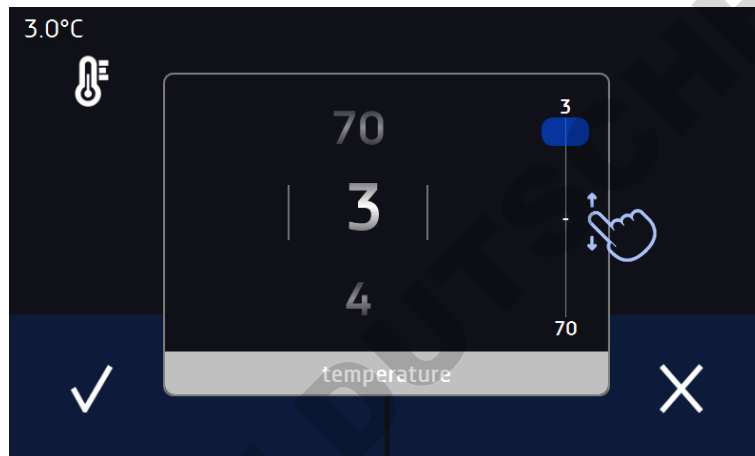





Figure 38 Quick change of set temperature - value setting



6.7.2. Quick change of set time

In order to quickly change the duration time of a running program, press the icon  in the main screen. Select the number of days, hours and minutes by scrolling the list up or down. Click  to confirm the change. To set the continuous work press .

To change the way of displaying the time, press::



– to display the elapsed time



– to display the remaining time

To change only the way of displaying, you do not have to confirm it by .

Figure 39 Quick change of set time- selection

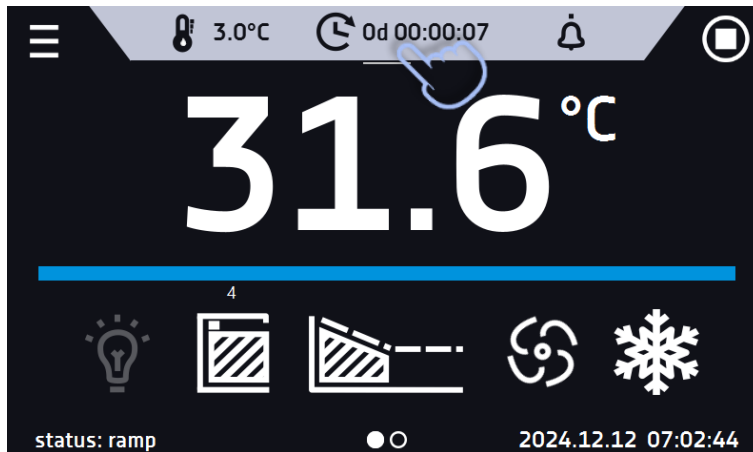
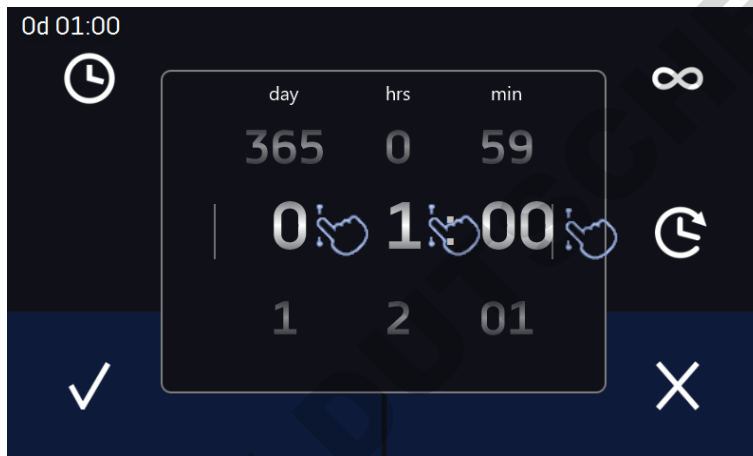

Figure 40 Quick change of set time - value setting



6.7.3. Quick change of fan efficiency (only for ILW)



In order to quickly change the fan efficiency, press the icon  in the main screen. The value should be selected by scrolling the list up or down. Press  to confirm the change.

Figure 41 Quick change of fan efficiency - selection

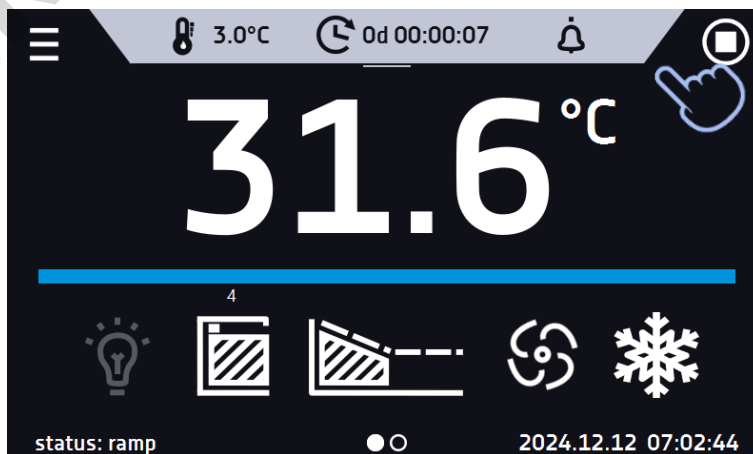



Figure 42 Quick change of fan efficiency- value setting



6.8. Statistics

Go to the main menu  and press the icon . This panel displays statistics of the currently running program or program that has ended. Statistics are calculated separately for each segment. Data logging for calculation starts after 30 seconds from reaching the set temperature in the segment. Further data is registered every 1 minute.

The following information is available:

- **set temperature [°C]** – set temperature in the segment,
- **minimum temperature [°C]** – the lowest recorded temperature,
- **maximum temperature [°C]** – the highest recorded temperature,
- **average temperature [°C]** – average temperature,
- **segment** – status of the segment:
 - **in progress** – currently running segment (data is being constantly updated),
 - **finished** – the segment has been completed,
 - **interrupted** – the segment was interrupted by the user before the set time has elapsed,
- **segment 1/2** – the number of the currently overviewing segment / number of the currently performed or completed segment. Navigating between the segments is done by swiping your finger up or down.

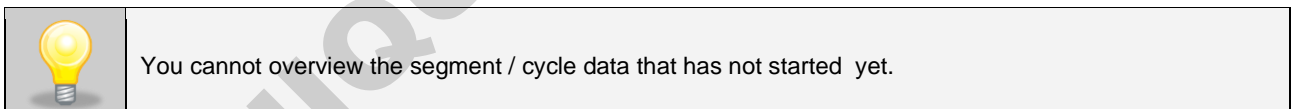
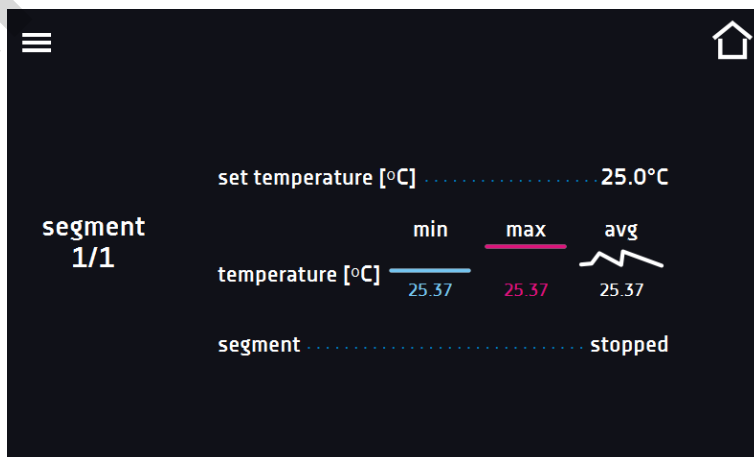

Figure 43 Statistics



6.9. Data record

Go to the main menu  and press the icon . Data record window contains the following information:

- time and date of sample registration [date],
- temperature value measured with the main sensor in the chamber [temp.].

It is possible to register 10 000 data records for the max period of 6 months. If all the memory cells are full, the oldest ones are overwritten. The data appears in the table in the order they were added, not in chronological order by the date. The most recently added record is at the top. The samples are only registered when the program is running. The frequency of registration depends on the program parameters settings.



When opening the data record, all data is downloaded. If the data download is interrupted by the user, press  to continue downloading of the rest of the data.

Figure 44 Data record



date	temp.	status
2024.12.12 07:04	31.56	ramp
2024.12.12 07:03	31.56	ramp
2024.12.12 07:02	31.56	ramp
2024.12.12 06:50	31.50	wait
2024.12.12 06:49	31.44	ramp
2024.12.12 06:48	31.50	ramp
2024.12.12 06:47	31.50	ramp
2024.12.12 06:46	31.56	wait

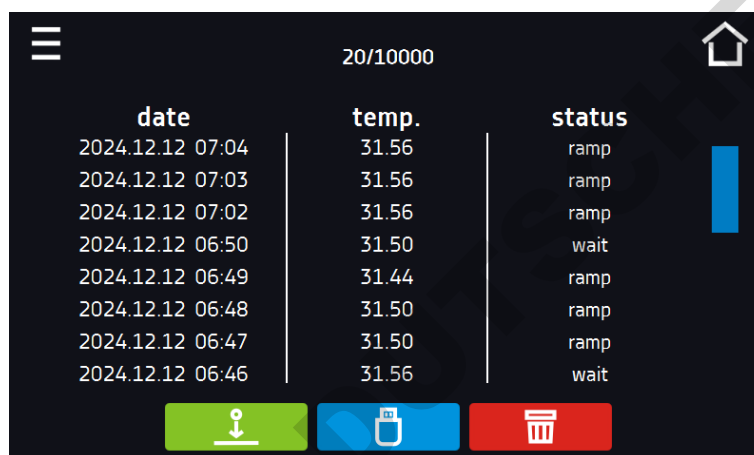

Press to continue downloading data.



Recording data onto the USB flash drive. .csv files are available - separated by semicolon when opening e.g. with a spreadsheet, .plx - opening with the Lab Desk application (option)



Before removing the USB flash drive from the USB port, it must be unmounted, see [Section 5.9.](#)



Deleting data

If there is a lot of data, a progress bar appears on the display

Figure 45 Progress bar

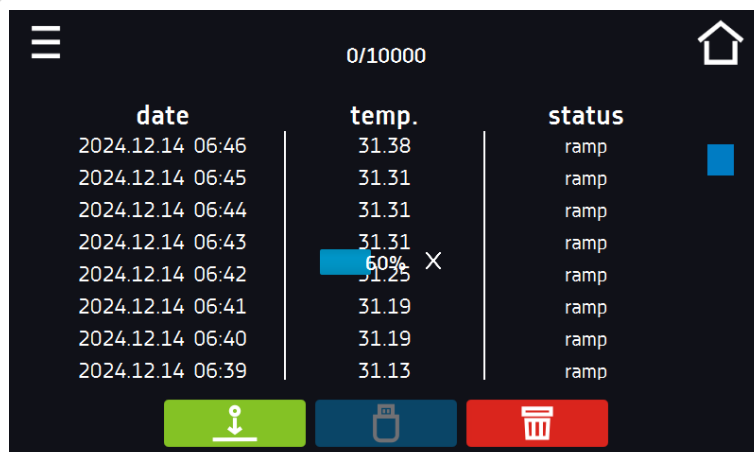

date	temp.	status
2024.12.14 06:46	31.38	ramp
2024.12.14 06:45	31.31	ramp
2024.12.14 06:44	31.31	ramp
2024.12.14 06:43	31.31	ramp
2024.12.14 06:42	31.25	ramp
2024.12.14 06:41	31.19	ramp
2024.12.14 06:40	31.19	ramp
2024.12.14 06:39	31.13	ramp

Figure 46 Deleting data

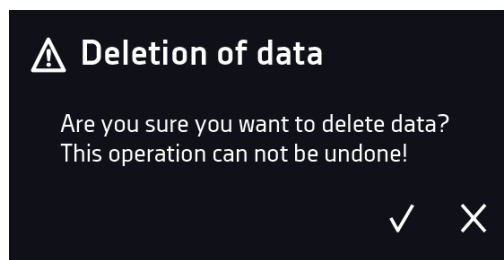

6.10. Event log

The log can store up to 10,000 events. When the memory reaches its capacity, new data automatically overwrites the oldest entries.



Go to the main menu  and press the icon . The window displays information about registered events, alarms and errors.

Figure 47 Event log



For program-related events, after pressing the event name, the program name is displayed.

Figure 48 Event log

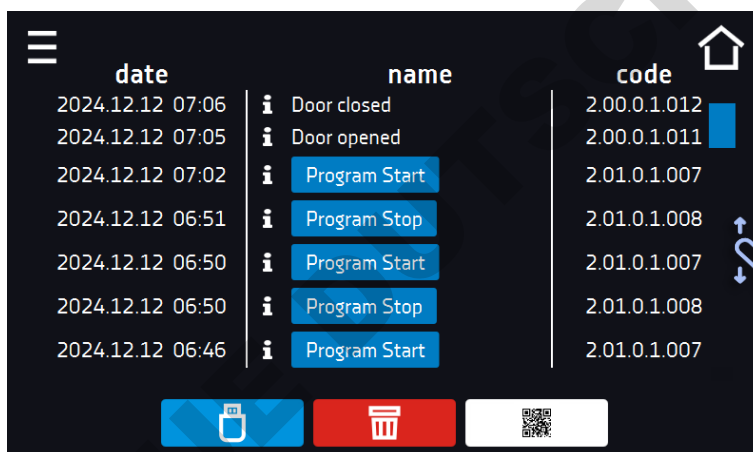
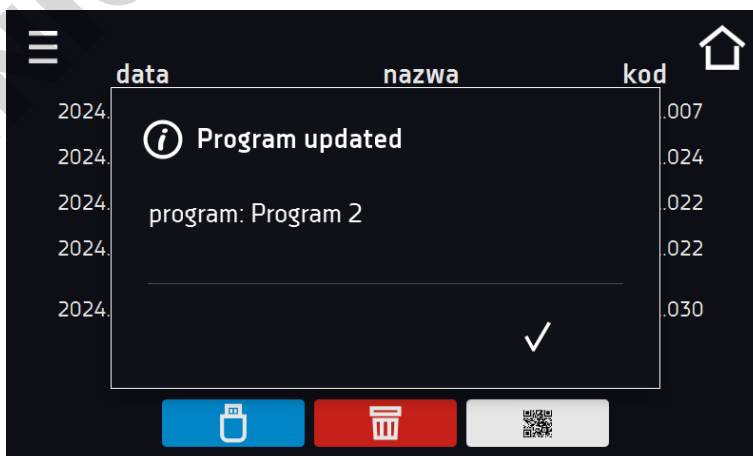

Recording data onto the USB flash drive. .csv files are available - separated by semicolon when opening e.g. with a spreadsheet, .plx - opening with the LabDesk application (option)



Before removing the USB flash drive from the USB port, it must be unmounted, see [Section 5.9](#).



Deleting data

QR code – opens smart4lab.eu (in the "Support" tab there are explanations of some of the information



appearing in the event log). Press the symbol  and enlarge the code QR, and then scan it with your smartphone

Figure 49 QR code

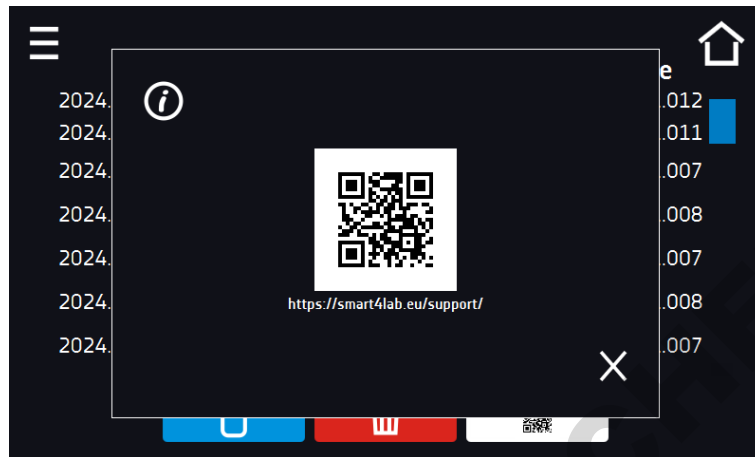

The events in the event log are sorted chronologically. However, it may happen that the event "Program restarted" will not be displayed according to the chronology but the date and time of the event will be correct. This is not an error.



Before removing the USB flash drive from the USB port, it must be unmounted, see [Section 5.9](#).

Information signs in the event log:

-  Information event
-  Alarm event
-  Error
-  Warning

Possible events:

Program Start	starting the program
Program Stop	stopping the program
Program Edit	changing the program parameters
Program End	program is completed
DeviceOn	the device is switched on (on the main switch)
DeviceOff	the device is switched off (on the main switch)
Door opened	the door is opened
Open door alarm start	open door alarm has been activated
Door closed	the door is closed
Open door alarm stop	open door alarm has been deactivated
Program Restarted	program has been resumed after power failure

Under Protection Start	under-temperature protection has been activated
Under Protection Stop	under-temperature protection has been deactivated
Upper temp. alarm Start	over- temperature protection has been activated
Upper temp. alarm End	over- temperature protection has been deactivated
Date/time change	date/time has been changed
Lower temp. alarm Start	activation of the alarm of exceeding the temperature below the set temperature
Lower temp. alarm End	deactivation of the alarm of exceeding the temperature below the set temperature
Upper temp. alarm Start	activation of the alarm of exceeding the temperature above the set temperature
Upper temp. alarm End	deactivation of the alarm of exceeding the temperature above the set temperature
Program saved	new program has been saved
Program deleted	program has been deleted
Program updated	program has been updated
Time Zone Changed	in the time settings the time zone has been changed
Temperature Correction Changed	main sensor temperature correction has been changed
Emergency stop of the program	the program has been automatically stopped – there was a situation that didn't allow the program to be continued. PLEASE CONTACT THE SERVICE
Defrosting Start	starting the defrosting process
Defrosting Stop	stopping the defrosting process
Power Fail Start	power failure / device fuse blown out.
Power Fail Stop	power resumed, returned to maintain program parameters



6.11. Info

Go to the main menu  and press the icon . The panel contains the following information:

- name of device,
- temperature range of the device,
- serial number of the device,
- Software version,
- manufacturer's address,
- manufacturer's website,
- QR code.

Figure 50 Info window (example)





Press icon  to save the "Download" folder (with instruction manual) on the USB flash drive. After inserting the flash drive into USB port wait few seconds until the information "Flashdrive connected" will appear on the display - for more information go to the [Section 6.1](#). Press the icon  to write the service data on the USB flash drive – contact the service for more information.

Press  to go to the main screen.



Before removing the USB flash drive from the USB port, it must be unmounted, see [Section 5.9](#).

6.12. User settings panel

Go to the main menu  and press the icon . In this panel you can:







	Change the name of the equipment – by default, the device serial number is entered.
 English	Change the language in the equipment's menu.
	Set the time after which the screen will be dimmed.
 <input type="checkbox"/>	Turn on/off the sound . Critical alarms will continue emitting a sound.
	Set the time after which the user will return to the home screen. Available settings: off, 1 min, 3 min, 5 min, 10 min.
	Set the automatic screen lock. Available settings: off, 5 min, 15 min, 30 min, 60 min. Factory setting: disabled.

Figure 51 User settings panel 



Confirms changes



Cancels the entered changes



6.12.1. Unlocking the touch screen

When the automatic touch screen lock is enabled ([Section 6.16](#)), slide the blue circle into the white circle to unlock the screen.

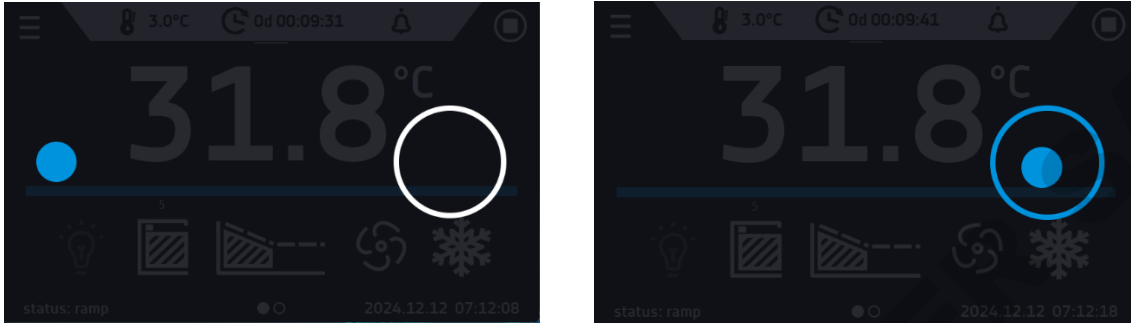
Figure 52 Unlocking the touch screen



6.13. Time

Go to the main menu  and press the icon . In this panel you can:

- [change the date / system time](#)

	If the date / system time is changed to the later date / time comparing with the data and events which are stored in the memory, they will remain in the register. If the date / system time is changed to the earlier date than the date / time which is stored in the memory, they will be transferred to the archive
---	---

After changing the date / system time the device will be restarted.

- [change time zone](#) - the change of time zone will not affect the date / time in data and events previously saved.

To change the date / system time it is necessary to press  in the window. The window will appear and you will be able to make changes.

Figure 53 Time zone change

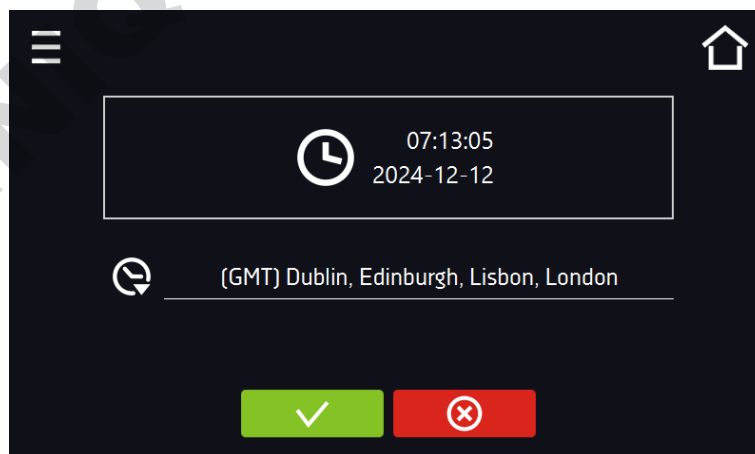

Confirms changes and restarts the device



Cancel the entered changes

Figure 54 Date / time change



6.14. Alarms

6.14.1. Alarms when set parameters are exceeded

Press the main menu icon , and then press . Here you can set parameters related to alarms

- **low alarm** – an alarm will be generated if the temperature drops below the set value by the value specified in this field,
- **high alarm** – an alarm will be generated if the temperature increases above the set value by the value specified in this field.



In the "lower alarm" field you can enter a value from the range of -0.5°C to -5°C, and in the "upper alarm" field from the range of 0.5°C to 5°C.

Figure 55. Parameter exceedance alarms

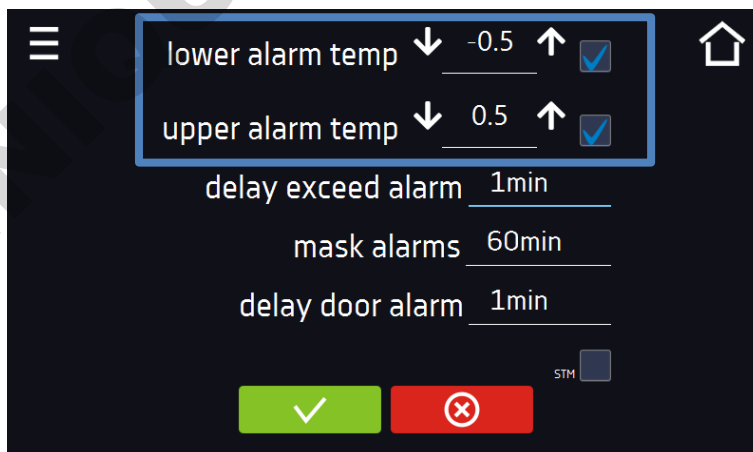

Confirm the changes.



Cancel the entered changes.

The upper and lower alarms can only be generated when the set temperature is reached.

- **temperature alarm delay:**
the alarm will be activated with a delay (1 min, 2 min, 5 min, 10 min, 15 min) after exceeding the permitted temperature.

6.14.1.1. Masking of parameter exceedance alarms

Masking of alarms when the set parameters are exceeded can be used when new samples are added to the chamber or samples are added to those already incubated. During these activities, the set parameters, i.e. temperature, may be exceeded and alarms may be activated - parameter exceedance alarms are set assuming that stable conditions prevail in the chamber (temperature) and the door is closed. After opening the door and placing the samples in the chamber, time is needed for the parameters to stabilize - the alarm masking function allows you to delay alarms when the parameters are exceeded.

The parameter exceedance alarm will be triggered with a delay (15 min, 30 min, 45 min, 60 min, 120 min, 150 min, 180 min) after inserting new samples. The time is counted from the last time the door was opened. Setting 0 s means masking is disabled.



If the door is opened during the parameter exceedance alarm, the ongoing alarm will not be "masked". Only the next alarm can be masked.

Figure 56. Alarm masking

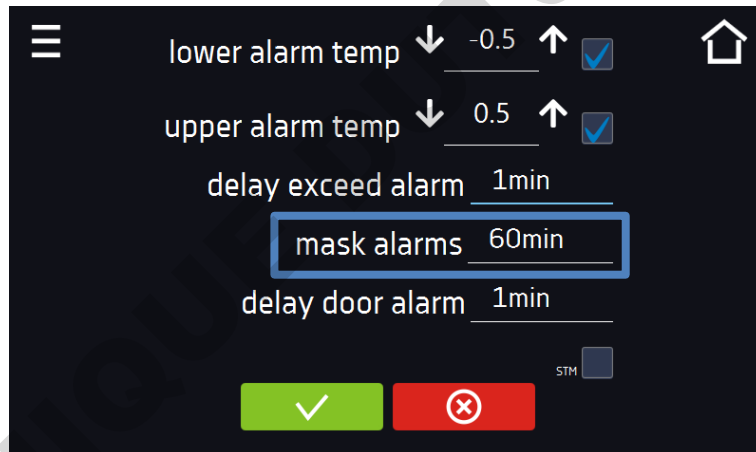

Confirm the changes.



Cancel the entered changes.

Figure 57 Alarm masking enabled



6.14.2. Open door alarm

All devices are equipped with an open door sensor. If the door is left open longer than the time set by the user, an acoustic signal, a red flashing alarm bar and a "door open" alarm with the status "active" will appear.

- **door open alarm delay:**
The door alarm will sound when the door is open for the user-selected time (30 sec, 1 min, 2 min, 5 min, 10 min).

Figure 58. Open door alarm delay

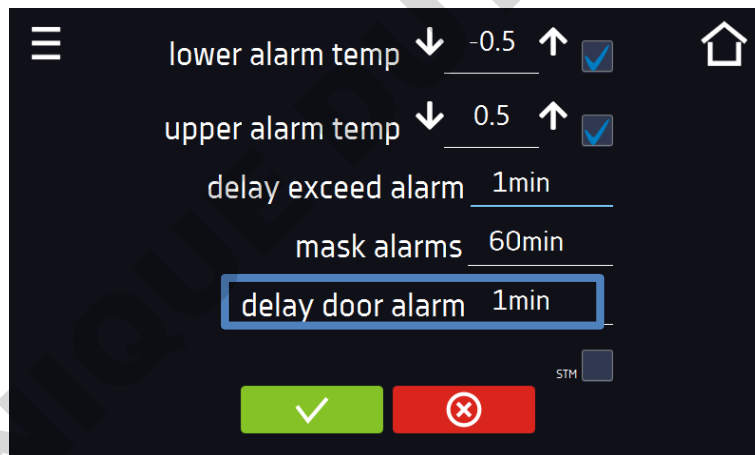

Confirm the changes.



Cancel the entered changes.

6.14.3. STM function

The STM (Smart Temperature Monitor) function informs the user if there is a problem in reaching or maintaining the set temperature. The user can enable/disable the function.

If the STM function is enabled, the STM symbol will appear on the screen next to the temperature of the main sensor.

Figure 59. Enable/disable STM function

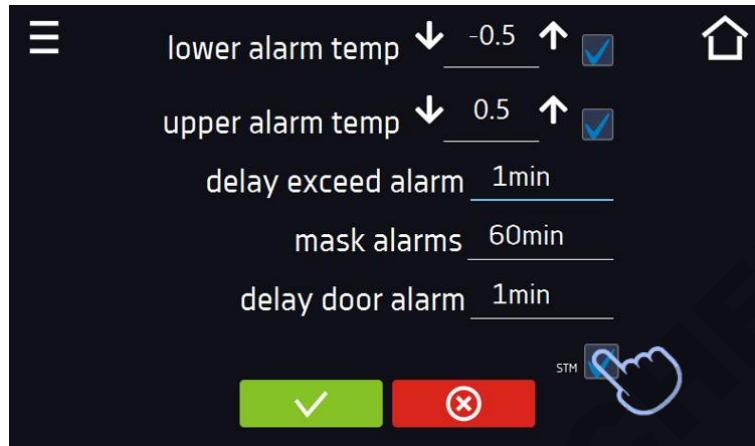

Confirm the changes.



Cancel the entered changes.

The function status is indicated by color:

- no inscription – option disabled,
- white color – option enabled, program is stopped,
- blue color – option enabled (temperature monitoring), program running,
- red color – option enabled, warning about problems with achieving/maintaining temperature.

Figure 60. STM Function - option enabled, program is stopped

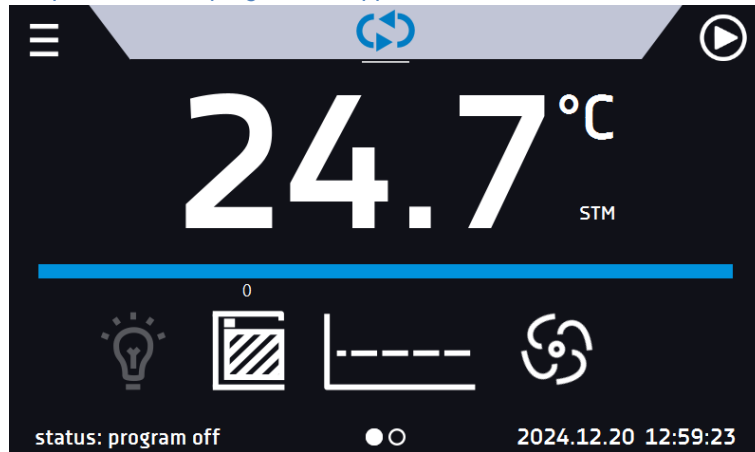

Figure 61. STM Function - option enabled, program running

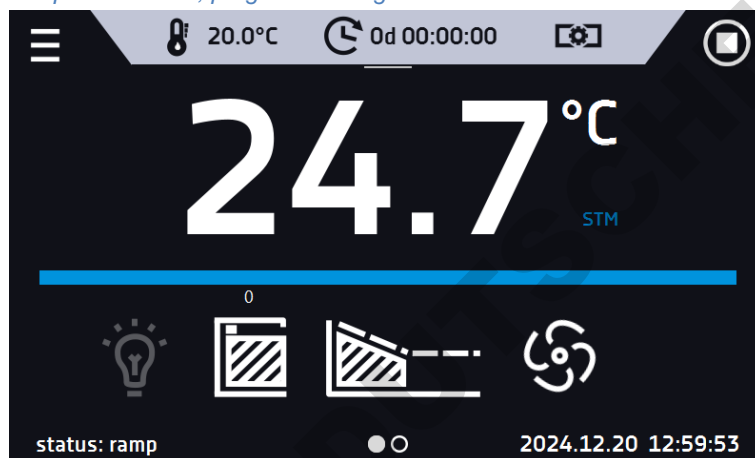
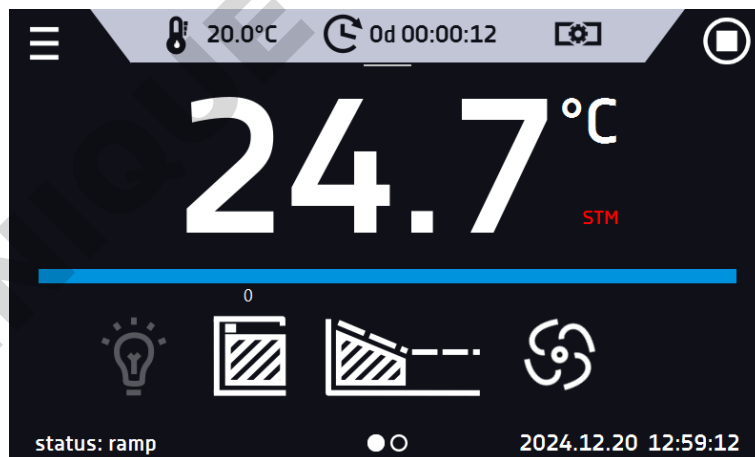

Figure 62. STM Function - option enabled, warning about problems with achieving/maintaining temperature



Possible causes of operation:

1. damaged heater,
2. the cartridge inserted into the chamber absorbs / releases too much energy.

If the color was red before opening the door, then the color changes to blue after opening the door.

If the function is activated (detection of problems with achieving/maintaining temperature):

- the warning 4.00.0.1.009... appears in the event log.
- the color of the STM inscription changes to red and remains red throughout the disruption, segment change, and program shutdown.
- when the state changes from red to blue, an entry about the end of function 4.00.0.1.010 appears in the event log.

6.14.4. Mute option

The icon  in the main screen in the upper menu allows temporary switching off of the alarms sound (open door alarm, exceeding temperature range), e.g. to avoid door alarm during planned loading of the samples into the chamber. There are options to turn off the sound for 5, 10 and 15 minutes, however, the sounds of critical alarms (e.g. damage to the temperature sensor, over- and under-temperature protection) will be still emitted.

Figure 63 Setting the time of mute function



6.15. Network

Go to the main menu  and press the icon . In this panel you can change LAN settings:

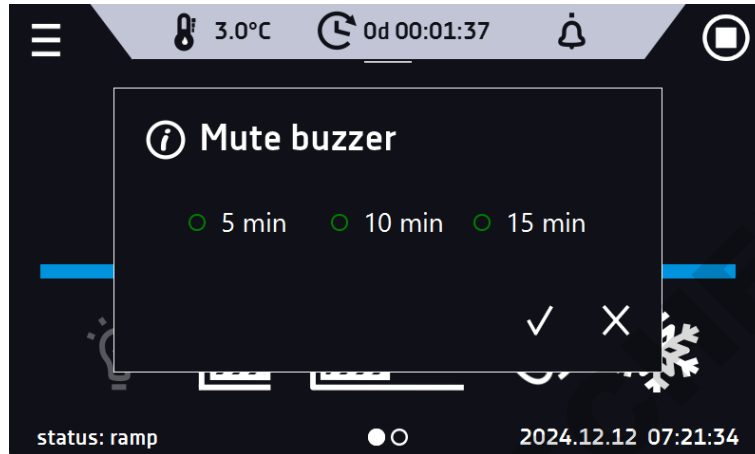
- **IP** – the device's IP address
- **Mask** – an Ethernet network mask to which the device is connected
- **Gate** – Server's IP address or router's that manages the Ethernet network
- **DNS** – IP address of the domain name system
- **MAC** – the address of the network card, read-only
- **DHCP** – you can select if the server that allocates IP addresses is running on the local network. You can then skip setting IP, Masks, Gates

Icon **A** indicates the connection status:



Device connected to the network



Device disconnected from the network

Figure 64 – LAN settings

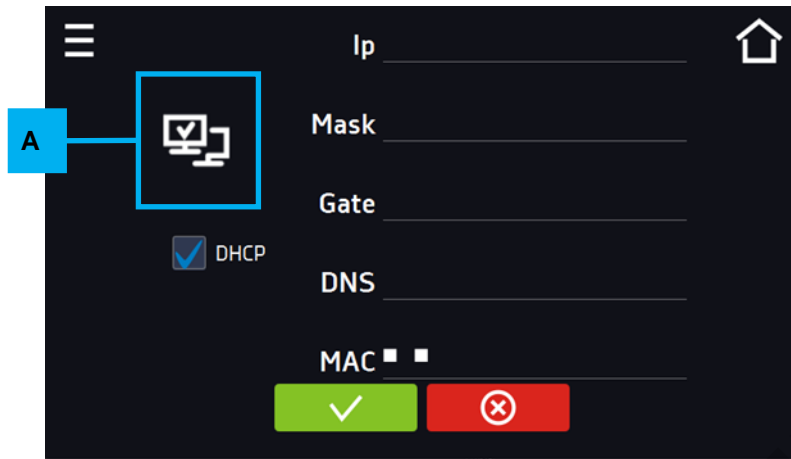

Confirms changes





Cancel the entered changes

6.16. Automatic defrosting function (optionally for ST 1-6, ST 500-1450, CHL 1-6, CHL 500-1450, ILW, standard for ST 500 M-1450 M i CHL 500 M-1450 M) *1

*1 – All models which are equipped with automatic defrosting (ST/CHL PLUS) don't have a standard defrosting function. The automatic defrosting function it's a recommended option available for ST 1-6 and ST 500 – 1450 thermostatic cabinets, laboratory refrigerators CHL 1-6 and CHL 500 – 1450 and ILW laboratory incubators. ST 500 M – 1450 M thermostatic cabinets and laboratory refrigerators CHL 500 M – 1450 M are equipped with automatic defrosting function as standard (these equipment have a cooling system in the form of a monoblock which is no Frost). Remember that as in the case of the automatic defrosting function in ST 1-6 and ST 500 – 1450, CHL 1-6 and CHL 500 – 1450 models, defrosting parameters in equipment with monoblock should be defined in the program as described below.

	Default settings - 2 minutes defrosting every 2 hours, causes a temporary increase in temperature in the chamber. Defrosting parameters can be changed by the User depending on the application - test type (wet / dry), door opening frequency, etc.
---	---

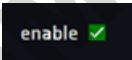
Go to the main menu  and press the icon . In this panel you can control the defrosting of the interior of the device. Option available for ST, CHL, ILW devices. The automatic defrosting function is active when the "enable" box is checked , otherwise the function will not work (neither default settings).

You can set:

- **Period [h]** – indicates the frequency of defrosting process for the set temperature $\leq 5^{\circ}\text{C}$.
- **Time [s]** – the time of defrosting,
- **Delay [min]** - time after defrosting that does not generate temperature alarms, given in minutes.

Pressing the button  – restores the default defrost settings (period [h]: 2, time [s]: 120, delay [m]: 0).

NOTE: the option  must be selected.

Figure 65 Defrosting function

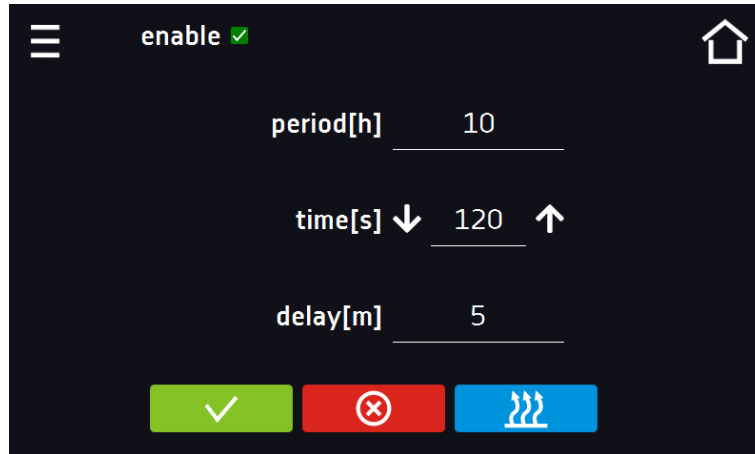

Confirms changes





Cancels the entered changes



Restores the default defrost settings

6.17. +/- Corrections

Go to the main menu  and press the icon . In this window you can correct temperature value indicated on the display by adding the correction value. The set correction value applies to the whole temperature range of the device. For example, if the average temperature displayed by the device indicates 20°C and the average temperature measured by independent, external sensor indicates 20,5°C, the correction should be set on +0,5°C. The average temperature should be calculated from chosen period of time e.g. 30 min. The correction available range is between - 5°C to +5°C.



The device has been calibrated by the manufacturer in accordance with applicable norms. The temperature shown on the display corresponds with a great accuracy to the temperature near chamber's sensor. For the correct operation of the device it is not necessary to use user's calibration. The user is performing temperature correction **on his own responsibility** and must be aware of consequences of changing manufacturer's settings. If the equipment was calibrated, calibration certificate **loses its validity**.

Figure 66 User's correction

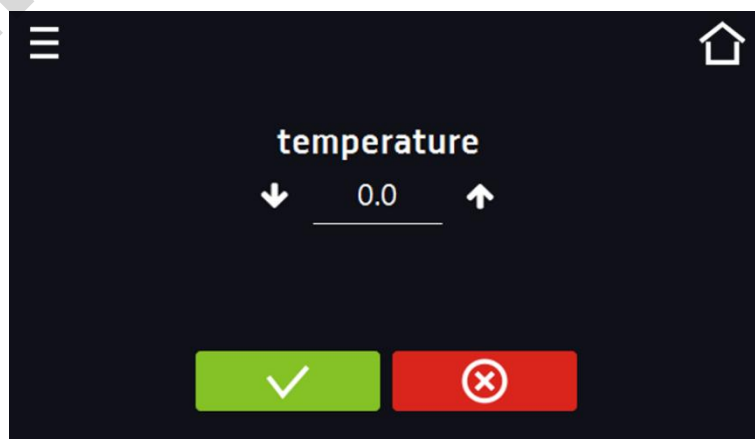



Confirms changes



Cancel the entered changes

7. INTERFACE

7.1. MODBUS TCP

The device allows status monitoring using the MODBUS TCP communication interface.

Connection parameters:

- IP address: same as device's (set in the panel in the [Section 6.15](#))
- port: 502

register INPUT REGISTERS			
function READ_INPUT_REGISTERS (0x30001)			
Address	Type	Multiplier	Description
0	int	10	temperature from the main sensor
3	bool	-	Open door
4	bit	-	b0 – door alarm b1 – upper temperature alarm b2 – lower temperature alarm b3 – over Protection b5 – main sensor error b6 – additional sensor error b7 – protection sensor error b8 – temperature sensors error b10 – hardware error b11 – MRW error

8. TEMPERATURE PROTECTION

The device is factory fitted with sample protection - temperature protection. If any of the elements responsible for maintaining the set temperature is damaged or the user sets the temperature unconsciously, the set protection will work.

8.1. Temperature protection class

Standard equipment in ST thermostatic cabinets and CHL laboratory refrigerators is protection class 1.0 according to DIN 12880. In ILW cooled incubators there's protection class 2.0 according to DIN 12880.

Optionally, the ST and ILW devices can be equipped with protection class 3.3 according to DIN 12880 and in CHL there's an option of class 3.2 according to DIN 12880. Then the User can program the temperature value of the lower / upper protection. When the set temperature is exceeded, the cooling or heating system power will be turned off. When the temperature returns to the allowed range, the device will resume operation. The figure below shows how this works.

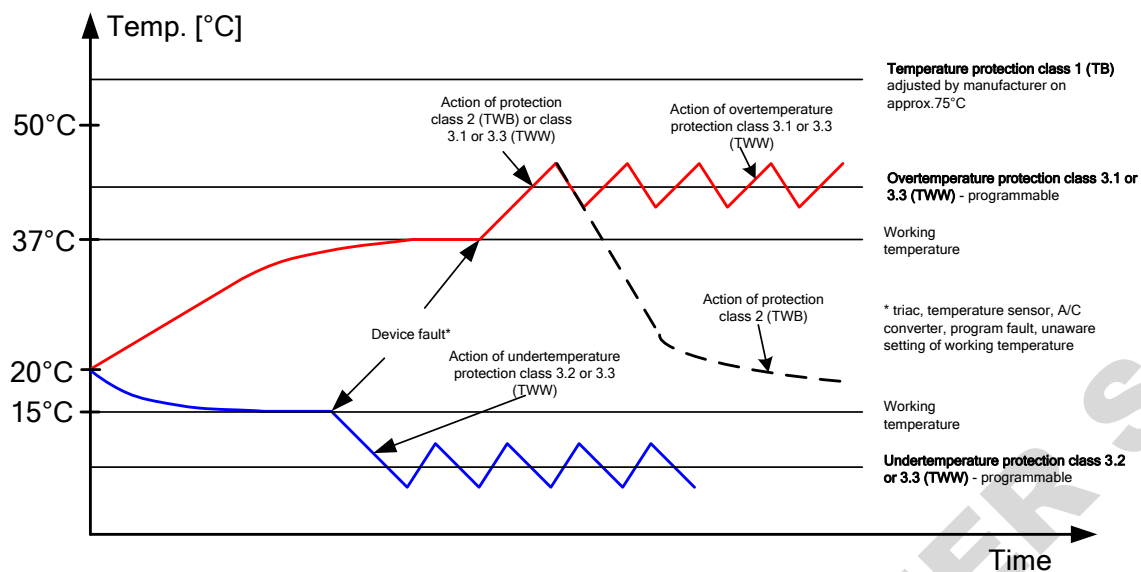

9. CONNECTING THE DEVICE TO A COMPUTER

Each device in the SMART version can be connected to an Ethernet network or directly to a computer with a LAN cable (optional equipment). To read data (stored data and event log), you need the Lab Desk software (optional equipment). If you purchase the software, a LAN cable is included together with a hardware key, which should be inserted into the USB port of the computer. The installed Lab Desk software and hardware key allow reading the data stored in the internal memory of the device. The features of the software have been described in a separate instruction manual.

10. OPERATION OF THE COOLING SYSTEM

In ST thermostatic cabinets, in the models: ST 1, ST 2, ST 3, ST 4, ST 5, ST 6, ST 500, ST 700, ST 1200, ST 1450, in CHL laboratory refrigerators, in the models: CHL 1, CHL 2, CHL 3, CHL 4, CHL 5, CHL 6, CHL 500, CHL 700, CHL 1200, CHL 1450 and in ILW laboratory incubators if the unit is operating in low temperatures the evaporator may get covered with ice. This can affect the lower cooling efficiency of the device.

In ST thermostatic cabinets, in the models: ST 500 M, ST 700 M, ST 1200 M and ST 1450 M, in CHL laboratory refrigerators, in the models: CHL 500 M, CHL 700 M, CHL 1200 M and CHL 1450 M the cooling system is based on a monoblock in which the evaporator is defrosted with warm gases, which prevents it from being frosted. Depending on the stored samples, defrosting parameters should be defined empirically (see [Section 6.16](#)).

To ensure proper operation of the device you should obey these principles:

1.	At temperatures above +8°C the air automatically defrosts the ice cover, defrosting is self-operating.
2.	At temperatures below +8°C the evaporator may be covered in ice and the device should be defrosted manually. If the unit works in a temperature below +8°C and the user does not defrost it periodically, the compressor may overheat and break down. This won't be covered by the warranty.
3.	The device is equipped with a protection mechanism against damaging the cooling system. The mechanism makes it impossible to turn on cooling when the temperature exceeds 45°C. As a result if the device has been programmed to go down to a lower temperature (e.g. from 60°C to 20°C) it may take longer for the program to operate until it reaches 45°C. The temperature inside the device is lowered naturally by emitting the heat to the

	surrounding environment. To speed up this process, it is recommended to open the chamber door for the time needed to cool the interior of the chamber.
4.	Always make sure that the door has been closed properly!

11. CLEANING AND MAINTENANCE OF THE DEVICE

	Disconnect the device from the power supply before carrying out any activities related to the cleaning! In the case of the battery back-up of the controller, also turn it off.
---	--

On the internal walls of the device (in particular the new one) made of stainless steel, discoloration (spots) may appear - which are not caused by factory defects, but only by the steel production process. They can be cleaned using extraction gasoline.

INOX products are manufactured with stainless steel. When used in standard laboratory conditions they do not rust. However it is possible that stains (which may look like rust) form on the steel surface (e.g. due to the kind of samples that are incubated in the chamber). In such case we recommend using cleaning solution (to clean the stains) which is dedicated to this particular application, e.g. Pelox.

	When cleaning stainless steel product with dedicated cleaning solution, one should pay attention to the suggestions and recommendations given in the instruction manual or in the safety data sheet of the cleaning solution.
--	--

11.1. Exterior cleaning

1.	The housing of the device should be cleaned at least once a week, depending on the working conditions.
2.	The housing and door should be cleaned with caution using a soft cloth dampened with water.
3.	Only mild cleaning products should be used to clean the device.
4.	Electrical parts should not get in contact with water or detergent.
5.	Clean the touch screen using a soft cloth or a foam for cleaning touch screens.
6.	USB port can be cleaned with a vacuum cleaner to prevent accumulation of dirt inside the port.

11.2. Interior cleaning

The interior of incubators, thermostatic cabinets and laboratory refrigerators in the COMFORT and PREMIUM versions is made of 0H18 stainless steel in accordance with with DIN 1.4301 or 0H17 acc. with DIN 1.4016. Stainless steel also corrodes. To slow down the corrosion process as much as possible, this type of steel requires regular maintenance and cleaning. Aggressive cleaning agents and preparations based on chlorine and bleach should be avoided, stainless steel should not be allowed to come into contact with non-alloy steel, unless we are dealing with ground steel, and avoid materials that may scratch the surface.

1.	Before cleaning the interior of the device, empty the chamber.
2.	Open the door of the device, if necessary wait till the chamber has cooled down, take out the shelves and start cleaning the device
3.	To clean the device, use a lint-free, lint-free, soft cloth and water or water with a mild detergent.

4.	In the case of ground steel, movements should be made in the direction of grinding on the surface.
5.	<p>If rust occurs:</p> <ul style="list-style-type: none"> • slight discoloration - use household cleaners for stainless steel containing calcium carbonate or citric acid, • medium discoloration - clean with a 10% phosphoric acid solution; after cleaning, neutralize the acid with diluted ammonia or a mild alkaline detergent, • severe rust – use products for pickling and passivation of steel – for example Pelox FR-D <p>After each cleaning, wipe the surface thoroughly with clean water.</p>
6.	Having finished cleaning, you should allow the device to dry fully and instal all parts removed before cleaning.
7.	During cleaning you should make sure not to damage the temperature sensors which are located inside the chamber.
8.	<p>At least once every 6 months clean the condenser with a vacuum cleaner, dry cloth or a soft brush. Placement of the condenser depends on the device: in the upper back (models with the capacity: 500, 700, 1200, 1450), in the back (models with the capacity: 1, 2, 3, 4, 5, 6). In the ILW laboratory incubators, the condenser is located at the bottom front. To access it, pull the ventilation cover (a) towards you and then pull it up (b). After cleaning the condenser (1), install the cover.</p>

for: **ST 1, ST 2, ST 3, ST 4, ST 5, ST 6**
CHL 1, CHL 2, CHL 3, CHL 4, CHL 5, CHL 6

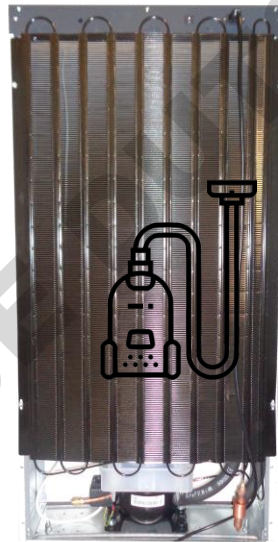

rear view

for: **ST 500 M, ST 700 M, ST 1200 M, ST 1450 M**
CHL 500 M, CHL 700 M, CHL 1200 M, CHL 1450 M

Before cleaning the condenser with a monoblock system, disconnect the device from the mains. To clean the condenser, it is not necessary to remove the cover. The condenser should be cleaned with a vacuum cleaner or a soft brush. After cleaning, the condenser should be free of dust and solid impurities. Cleaning should be performed every 6 months or when you notice that the condenser is dirty.

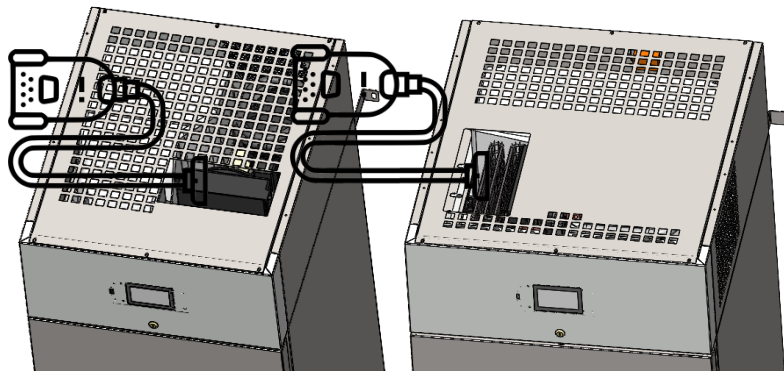

model 500

model 700

for ILW

1.

2.

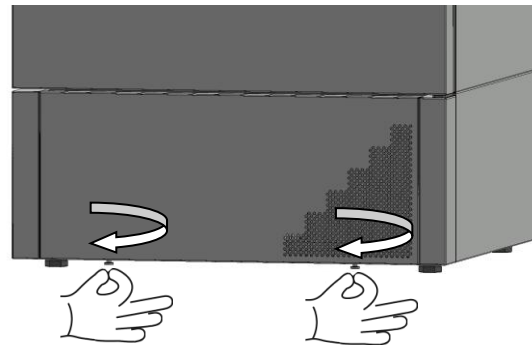
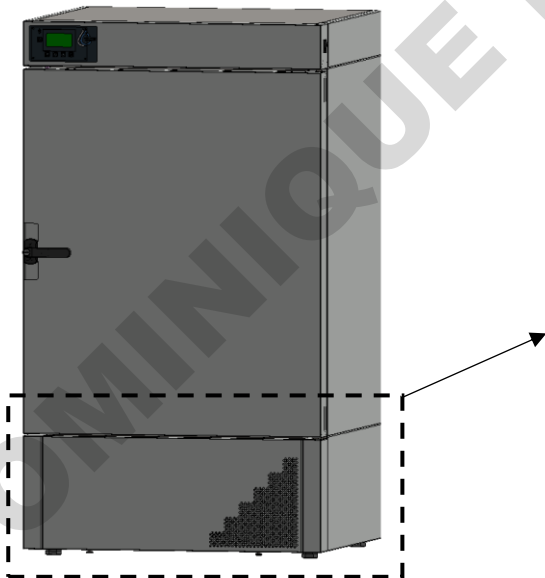

To loosen (one rotation)

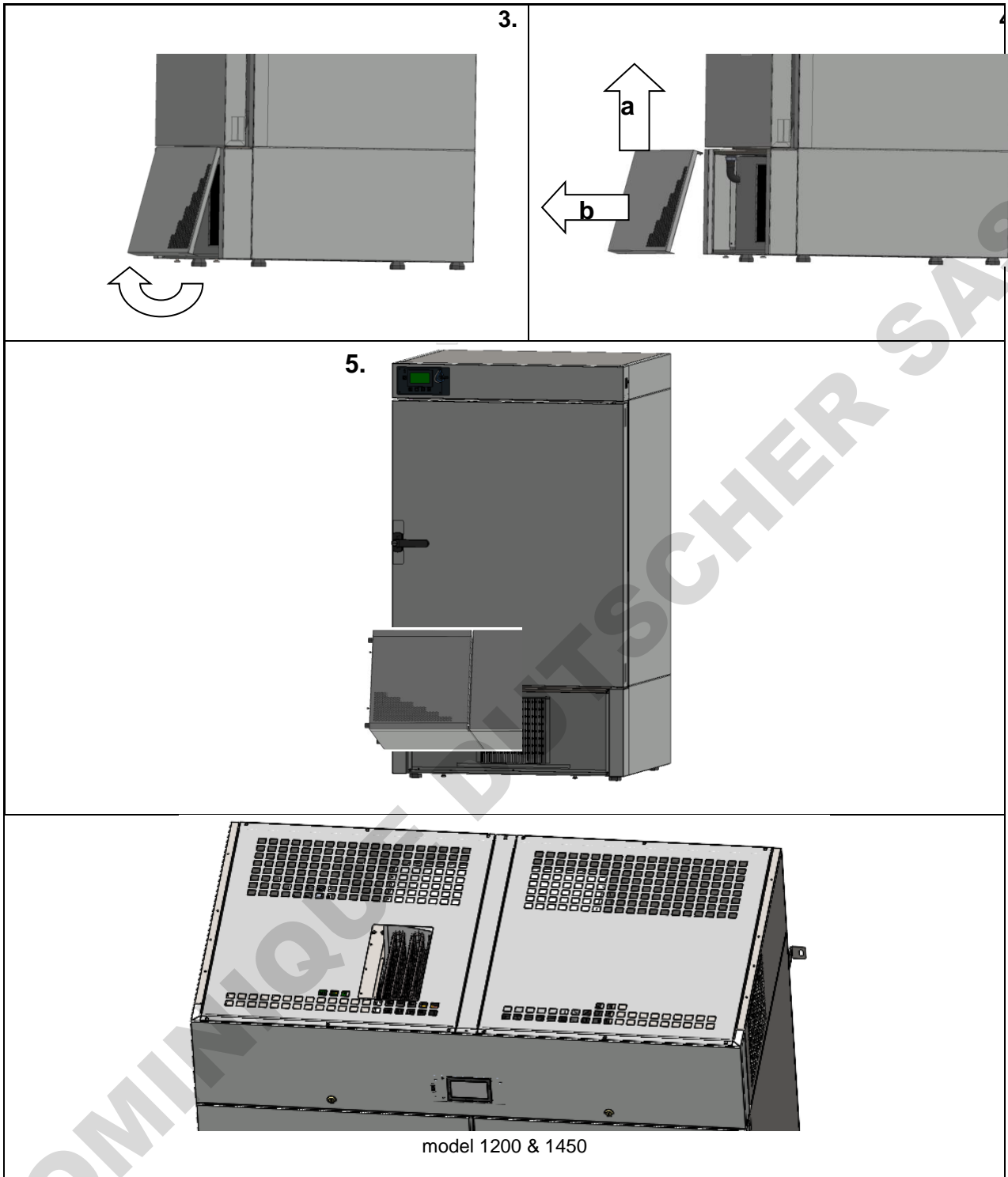

Failure to clean regularly may result in damage to the compressor and loss of the rights for repair under warranty.

11.3. Cleaning the touch screen

The touch screen is exposed to dirt, so it must be cleaned regularly. To clean the touch screen, use a clean and dry microfiber cloth. It is a very delicate material and collects dirt well.

	Before using the cloth, make sure that on the surface there are no crumbs or particles. During cleaning, they can act like sandpaper and scratch the surface of the screen.
---	--

If the stains cannot be removed by dry cleaning, the cloth can be lightly dampened with water.

	Do not use paper towels to clean the screen as it may cause microdamages.
---	--

Before cleaning, lock the screen by pressing  on the top drop-down list.

Figure 67 Locking the screen



The screen is ready to be cleaned.

To unlock the touch screen, slide the blue circle into the white circle

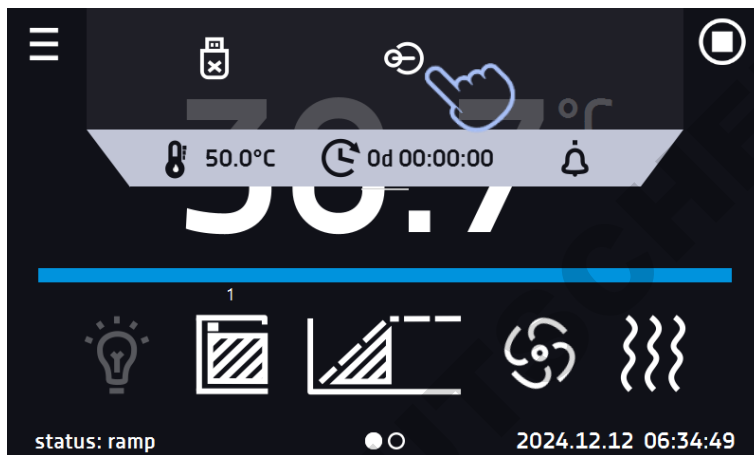
Figure 68 Unlocking the screen

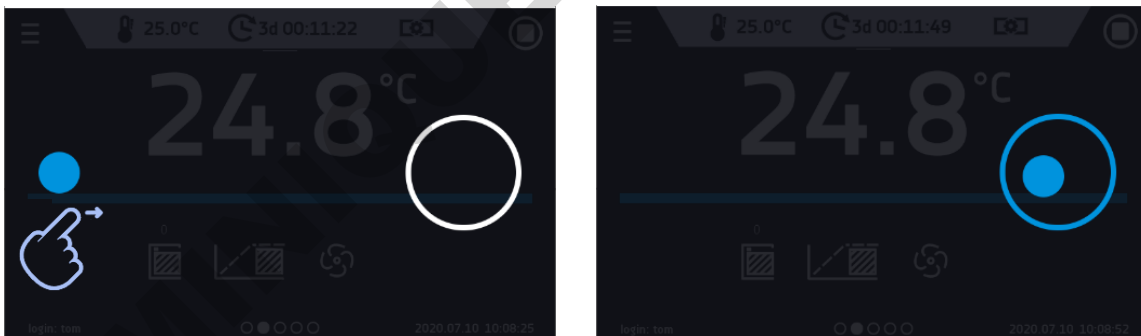

12. ADVICE ON HOW TO SAFELY STORE THE DEVICE

1.	Remove all objects from the chamber.
2.	Disconnect the device from the mains. If the unit is equipped with battery back-up of the controller (optional), also turn it off.
3.	Clean and dry the chamber.
4.	Leave the door open to avoid unpleasant odors.
5.	Store in temperatures between 0°C and 50°C and relative humidity maximum 70%.

13. TROUBLESHOOTING

Before you contact Service Department:

1.	Make sure that the operation complies with the instruction manual of the device.
2.	Restart the device to make sure that the unit is not functioning properly. If it still does not work, disconnect the unit again from the mains and repeat the operation after one hour. Do the same with optional battery back-up of the controller.

Service

Visit the POL-EKO® website at: www.pol-eko.com.pl in order to:

- get full contact details of technical service
- access to POL-EKO® online catalogue, and information about accessories and related products
- receive additional product information and special offers

To receive information or technical assistance, contact the Service Department or visit the website: www.pol-eko.com.pl

13.1. Possible defects

Malfunction	What to check?	What to do?
The unit is not working	Check if the unit is plugged in correctly	Plug in the unit correctly
	Check if the circuit-breaker has tripped	Press the circuit breaker on the back of the device
	Check the voltage in the socket	Connect the device to a different socket, preferably from a different electrical circuit. Call a licensed electrician to check the electrical installation.
	Check if the power cable is broken	Change the cable
The unit is not cooling down	Check if the condenser is dirty	Clean the condenser
	Check if the unit is exposed to direct sunlight	Change the location of the unit
	Check if there is a heat emitter near the device	Change the location of the unit
	Check if the door is closed properly	Clean the gasket
The unit is not heating up	Check if the door of the unit is closed properly	Clean the gasket
	Check if the fan is turned on	Set the fan operation in the program
	Check if the ambient temperature is within the permissible values given in the technical data table?	Adjust the ambient temperature to the value given in this manual
The unit is working too loud	Check if the unit is not touching other objects or furniture etc.	Remove other objects
	Check if the door is properly leveled	Level the device
The door has dropped or is skewed	Check if the door is properly leveled	Level the device. If this does not help, contact the service.



For ILW, ST and CHL: gurgling sound of the refrigerant fluid flowing in the refrigerant circuit is normal.

14. WARRANTY CONDITIONS

POL-EKO® warrants that this product will be free from defects in material and workmanship for a period of two (2) years from date of the invoice. If a defect is present, POL-EKO® will, at its option and cost, repair, replace, or refund the purchase price of this product to the customer, provided it is returned during the warranty period. This warranty does not apply if the product has been damaged by accident, abuse, misuse, or misapplication, or from ordinary wear and tear. If the required maintenance and inspection services are not performed according to the manuals and any local regulations, such warranty turns invalid.

The device that is being returned must be secured by the customer in the event of any damage or loss. The warranty will be only limited to the situations listed above. IT IS EXPRESSLY AGREED THAT THIS WARRANTY WILL BE IN LIEU OF ALL WARRANTIES OF FITNESS AND IN LIEU OF THE WARRANTY OF MERCHANTABILITY.

All complaints should be reported using the form available on the website <http://www.pol-eko.com.pl/en/service>

Compliance with local laws and regulations

The user is responsible for obtaining any approvals or authorizations required to launch and use the product.

POL-EKO® shall not be liable for any negligence in the above matter except when the refusal to obtain authorization is caused by a product defect.

15. RATING PLATES

The rating plate is located on the left side wall in the upper left corner. Below there is an example of a rating plate:

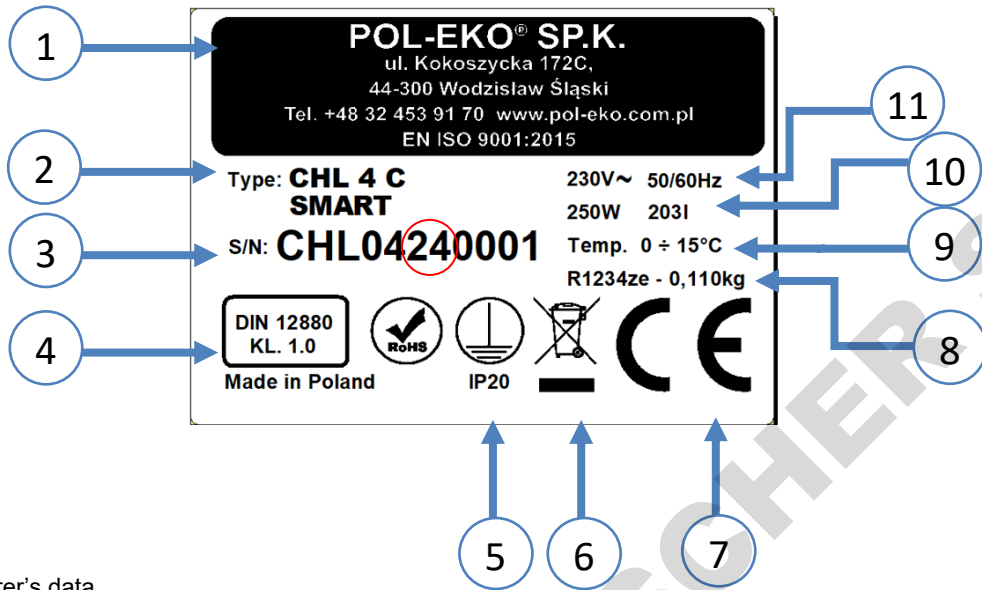

1. Manufacturer's data
2. Type of device
3. Serial number (the two marked digits indicate the year of manufacture of the device)
4. Temperature protection class according to DIN 12880
5. Degree of protection against electric shock (class I: protection against indirect contact) and IP enclosure protection rating
6. Disposal of used device according to WEEE2
7. CE marking as confirmation of compliance with the directives
8. Temperature range of the device
9. Information about cooling system (gas type and quantity)
10. Capacity of device
11. Acceptable range of voltage and frequency of mains supply

The numbers marked with a red circle indicate the year of manufacture of the device.

16. TECHNICAL DATA

Technical data are given with a tolerance of $\pm 5\%$, the working capacity of the chamber is always smaller. All the below technical data refers to standard units (without optional accessories).

16.1. ST, ST BD, CHL devices

Parameter		ST1 CHL1	ST2 CHL2	ST3 CHL3	ST4 CHL4	ST5 CHL5	ST6 CHL6	ST500 CHL500	ST700 CHL700	ST1200 CHL1200	ST1450 CHL1450	
Air convection		forced										
Chamber capacity [l]		70	150	200	250	300	400	500	625	1365	1540	
Working capacity [l]		55	122	163	203	243	324	411	499	1239	1376	
Door		solid / glass door or double ¹ (option)										
Temperature range [°C]	CHL	[°C]	0...+15						0...+15			
		[°F]	+32...+59						+32...+59			
	ST	[°C]	+3...+40 / up to +70 (option)									
		[°F]	+37...+104 / up to +158 (option)									
ST BD	[°C]	+3...+40										
	[°F]	+37...+104										
Temperature resolution [°C]		every 0,1										
Controller		microprocessor with external touch screen										
Interior	Smart B	aluminium										
	Smart C	stainless steel according to DIN 1.4016										
	Smart CS	stainless steel according to DIN 1.4016										
	Smart P	stainless steel according to DIN 1.4301										
	Smart PS	stainless steel according to DIN 1.4301										
Housing	Smart B	powder coated sheet										
	Smart C	powder coated sheet										
	Smart CS	polished stainless steel										
	Smart P	powder coated sheet										
	Smart PS	polished stainless steel										
Overall dims ² [mm]	A width	570	620	620	620	620	620	660	750	1480	1460	
	B height	660	900	1100	1300	1500	1900	1990	1990	1990	1940	
	C depth	680	650	650	650	650	650	810	860	860	960	
	D width	430	480	480	480	480	480	480	540	1270	1270	
Internal dims ³ [mm]	D' width	470	520	520	520	520	520	510	600	1340	1340	
	E height	430	660	860	1060	1260	1660	1510	1510	1510	1460	
	F depth	300	420	420	420	420	420	610	680	680	780	
	F' depth	360	480	480	480	480	480	-	-	-	-	
	G depth	-	320	320	320	320	320	-	-	-	-	
	H height	-	440	640	840	1040	1440	-	-	-	-	
	I height	-	-	-	-	-	-	1360	1360	1360	1300	
	I' height	-	-	-	-	-	-	-	-	-	-	
Max shelf workload ⁴ [kg]	-	10	10	10	10	10	10	20	30	30	30	
	version PW ⁵	on request						100	100	100	100	
Max unit workload [kg]	-	20	30	40	50	60	60	100	150	300	300	
	version W ⁶	on request										
Nominal power		consult rating plate of the device										
Total maximum load power of electrical sockets (option)		Σ_{max} 200 [W]										
Weight ⁸ [kg]		32	54	59	69	75	90	105	115	185	200	
Protection		class 1.0 according to DIN 12880 / class 3.3 (option)										
Power supply		consult rating plate of the device ⁷										
Shelves fitted/max		2/2	3/4	3/4	4/6	4/7	4/10	3/11	3/11	2x3/11	2x3/11	
Refrigerant		consult rating plate of the device										
Door number		1	1	1	1	1	1	1	1	2	2	
Warranty		24 months										
Manufacturer		POL-EKO®										

1. additional internal glass door
2. depth does not include 50mm of power cable
3. internal dimensions of the units with double door are always smaller
4. on uniformly loaded surface
5. reinforced shelf
6. reinforced version (extra paid option)
7. the rating plate is located on the left side of the device in the upper left corner
8. for the units with solid door in SMART version

16.2. ST M, CHL M devices with monoblock

Parameter		ST500 M CHL500 M	ST700 M CHL700 M	ST1200 M CHL1200 M	ST1450 M CHL1450 M
Air convection		forced			
Chamber capacity [l]		500	625	1365	1540
Working capacity [l]		469	611	1355	1525
Door		solid / glass door or double ¹ (option)			
Temperature range [°C]	CHL	[°C]	0...+15		
		[°F]	+32...+59		
	ST	[°C]	+3...+40 / do +70 (option)		
		[°F]	+37...+104 / do +158 (option)		
	ST BD	[°C]	+3...+40		
[°F]		+37...+104			
Temperature resolution [°C]		every 0,1			
Controller		microprocessor with external touch screen			
Interior	Smart B	aluminium			
	Smart C	stainless steel according to DIN 1.4016			
	Smart CS	stainless steel according to DIN 1.4016			
	Smart P	stainless steel according to DIN 1.4301			
	Smart PS	stainless steel according to DIN 1.4301			
Housing	Smart B	powder coated sheet			
	Smart C	powder coated sheet			
	Smart CS	polished stainless steel			
	Smart P	powder coated sheet			
	Smart PS	polished stainless steel			
Overall dims ² [mm]	A width	660	750	1480	1460
	B height	1990	1990	1990	1940
	C depth	810	860	860	960
Internal dims ³ [mm]	D width	480	540	1270	1270
	D' width	510	600	1340	1340
	E height	1510	1510	1510	1460
	F depth	610	680	680	780
	F' depth	-	-	-	-
	G depth	-	-	-	-
	H height	-	-	-	-
Max shelf workload ⁴ [kg]	-	20	30	30	30
	version PW ⁵	100	100	100	100
Max unit workload [kg]	-	100	150	300	300
	version W ⁶	on request			
Nominal power		consult rating plate of the device			
Total maximum load power of electrical sockets (option)		$\Sigma_{max.} 200 [W]$			
Weight ⁸ [kg]		105	115	185	200
Protection		class 1.0 according to DIN 12880 / class 3.3 (option)			
Power supply		230 [V] ±10% / 50 [Hz]			
Shelves fitted/max		3/11	3/11	2x3/11 ⁹	2x3/11 ⁹
Refrigerant		consult rating plate of the device			
Door number		1	1	2	2
Warranty		24 months			
Manufacturer		POL-EKO®			

1. additional internal glass door
2. depth does not include 50mm of power cable
3. internal dimensions of the units with double door are always smaller
4. on uniformly loaded surface
5. reinforced shelf
6. reinforced version (extra paid option)
7. the rating plate is located on the left side of the device in the upper left corner
8. for the units with solid door in SMART version

16.3. ST, CHL multi-chamber devices

Parametr			ST1/1 CHL1/1	ST1/1/1 CHL1/1/1	ST2/2 CHL2/2	ST2/3 CHL2/3
Air convection			forced			
Chamber capacity [l]			70/70	70/70/70	150/150	150/200
Working capacity [l]			55/55	55/55/55	122/122	122/163
Door			solid / glass door or double ¹ (option)			
Temperature range [°C]	CHL	[°C]	0...+15			
		[°F]	+32...+59			
	ST	[°C]	+3...+40 / do + 70 (option)			
		[°F]	+37...+104 / do +158 (option)			
Temperature resolution [°C]			every 0,1			
Controller			microprocessor with external touch screen			
Interior	Smart B		aluminium			
	Smart C		stainless steel according to DIN 1.4016			
	Smart C/S		stainless steel according to DIN 1.4016			
Housing	Smart B		powder coated sheet			
	Smart C		powder coated sheet			
	Smart C/S		polished stainless steel			
Overall dims ² [mm]	A width		570	570	620	620
	B height		1290	1920	1720	1910
	C depth		680	680	650	650
Internal dims ³ [mm]	D width		430	430	480	480
	D' width		470	470	520	520
	E height		430	430	660	660/860
	F depth		300	300	420	420
	F' depth		360	360	480	480
	G depth		-	-	320	320
	H height		-	-	440	440/640
Max shelf workload ⁴ [kg]	-		10	10	10	10
	version PW ⁵		on request			
Max unit workload [kg]	-		20	30	40	50
	version W ⁶		on request			
Nominal power ⁷ [W]			consult rating plate of the device			
Weight ⁸ [kg]			65	98	109	114
Protection	CHL		class 1.0 according to DIN 12880 / class 3.2 (option)			
	ST		class 1.0 according to DIN 12880 / class 3.3 (option)			
Power supply			consult rating plate of the device ⁷			
Shelves fitted/max			see table for single chamber devices			
Total maximum load power of electrical sockets (option)			$\Sigma_{max.} 200 [W]$			
Refrigerant			consult rating plate of the device ⁷			
Warranty			24 months			
Manufacturer			POL-EKO®			

1. additional internal glass door
2. depth does not include 50mm of power cable
3. internal dimensions of the units with double door are always smaller
4. on uniformly loaded surface
5. reinforced shelf
6. reinforced version (extra paid option)
7. the rating plate is located on the left side of the device in the upper left corner
8. for the units with solid door in SMART version

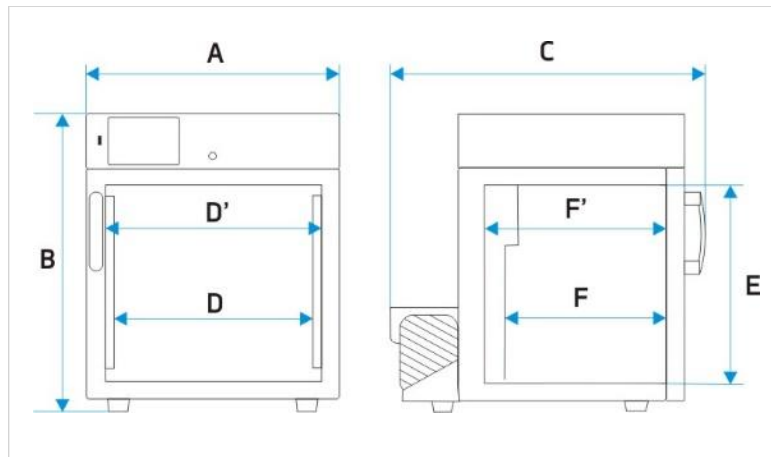

ST 1, CHL 1

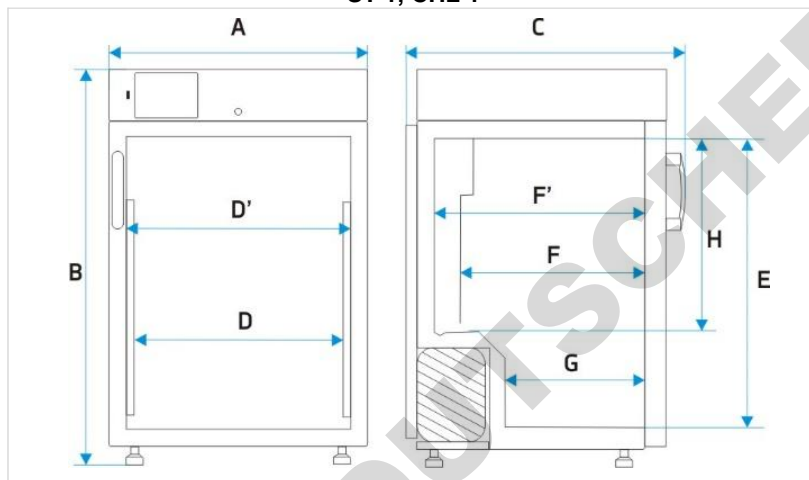

ST / CHL: 2,3,4,5,6

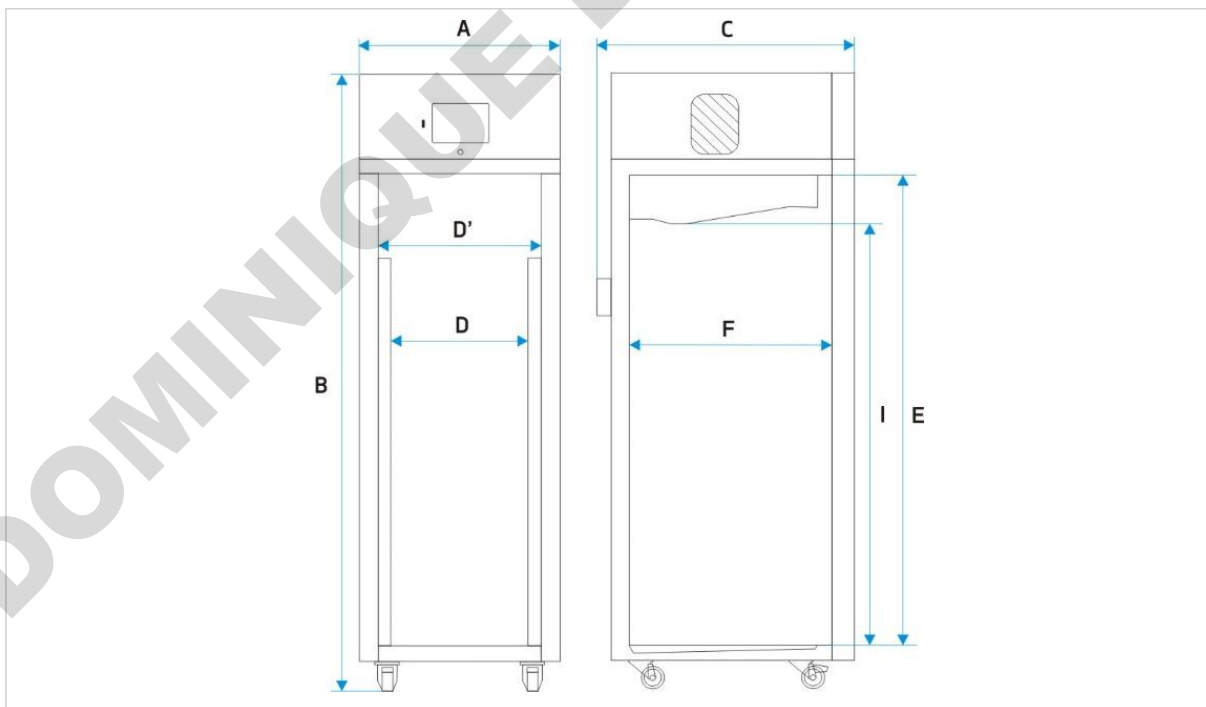

ST / CHL 500, 700, 1200, 1450

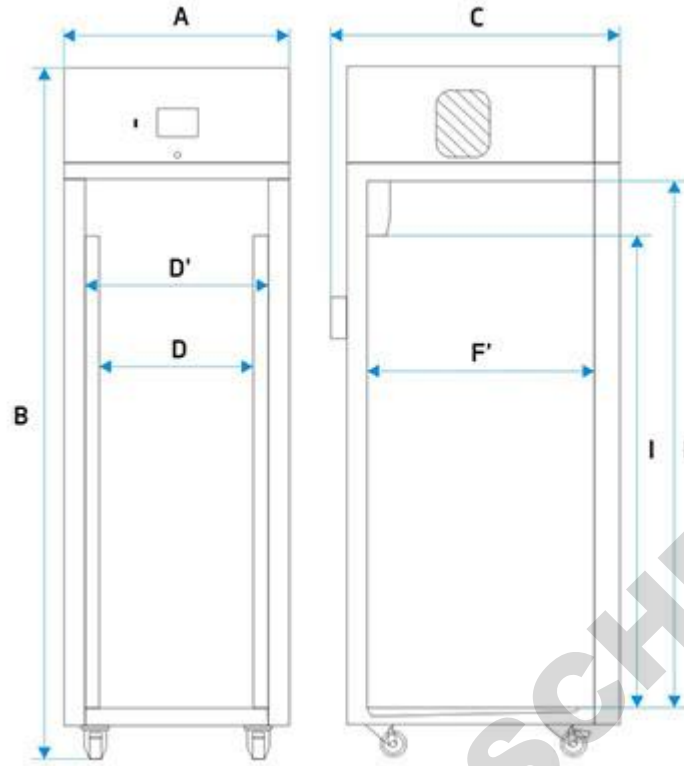

ST / CHL 500 M, 700 M, 1200 M, 1450 M

DOMINIQUE DUTSCHER SAS



16.4. ILW devices

Parameter		ILW53	ILW115	ILW240	ILW400	ILW750
Air convection		forced				
Chamber capacity [l]		56	112	245	424	749
Door		double / with viewing window (option)				
Temperature range [°C]		-10 (option)/0...+70				
Temperature range [°F]		14 (option)/32...+158				
Temperature resolution [°C]		every 0,1				
Controller		microprocessor with external touch screen				
Interior		acid-proof stainless steel according to DIN 1.4301				
Housing	Smart	powder coated sheet				
	IG Smart	stainless steel linen finish				
Overall dims ¹ [mm]	A width	610	660	820	1040	1260
	B height	960	1100	1430	1680	1910
	C depth	630	720	720	780	880
Internal dims [mm]	D width	400	460	600	800	1040
	E height	390	540	800	1040	1200
	F depth	360	450	510	510	600
Max shelf workload ⁴ [kg]	-	25	25	25	25	-
	version PW ²	50	50	100	100	100
Max unit workload [kg]	-	40	60	90	120	140
	version W ³	80	120	300	300	300
Nominal power [W]		consult rating plate of the device ⁵				
Weight [kg]		69	90	140	185	275
Protection		class 2.0 according to DIN 12880 / class 3.3 (option)				
Power supply		consult rating plate of the device ⁵				
Shelves fitted/max		2/5	2/7	3/10	3/14	5/16
Warranty		24 months				
Manufacturer		POL-EKO®				

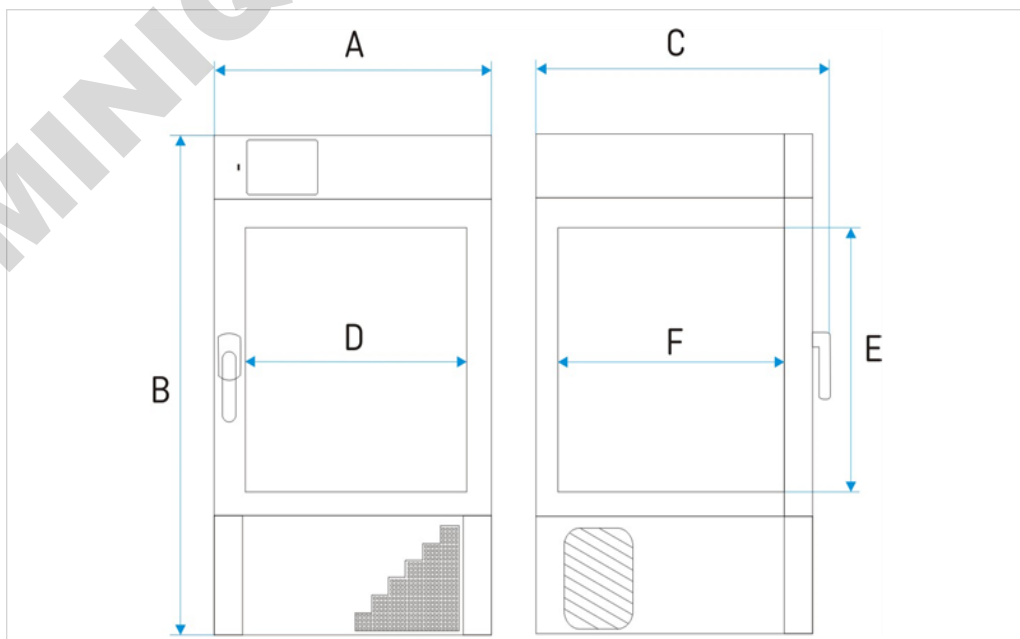
1. depth does not include 50mm of power cable
2. reinforced shelf
3. reinforced version
4. on uniformly loaded surface
5. the rating plate is located on the left side of the device in the upper left corner



17. DECLARATIONS OF CONFORMITY

 DEKLARACJA ZGODNOŚCI UE EU DECLARATION OF CONFORMITY		 POL-EKO®
Produkt:	Product:	
Chłodziarka laboratoryjna	Laboratory refrigerators	
Model:	Model:	
CHL 1; CHL 2; CHL 3; CHL 4; CHL 5; CHL 6; CHL 500; CHL 700; CHL 1200; CHL 1450; CHL 1/1; CHL 1/1/1; CHL 2/2; CHL 2/3; CHL 2/4; CHL 3/3; CHL2/ZLN85+; CHL3/ZLN85+		
w wersjach:	in version:	
C SMART; CS SMART; P SMART; PS SMART. CM SMART; CMS SMART; PM SMART; PMS SMART		
Nazwa i adres producenta:	Name and address of the manufacturer:	
POL-EKO® A.Polok-Kowalska sp.k. ul. Kokoszycka 172 C, 44-300 Wodzisław Śląski Polska/Poland		
Niniejsza deklaracja zgodności wydana zostaje na wyłączną odpowiedzialność producenta.	This declaration of conformity is issued under the sole responsibility of the manufacturer.	
Wymieniony powyżej przedmiot niniejszej deklaracji jest zgodny z odnośnymi wymaganiami unijnego prawodawstwa harmonizacyjnego:	The object of the declaration described above is in conformity with the relevant Union harmonisation legislation:	
LVD 2014/35/UE EMC 2014/30/UE RoHS 2011/65/UE & 2015/863UE WEEE 2012/19/UE	LVD 2014/35/EU EMC 2014/30/EU RoHS 2011/65/EU & 2015/863EU WEEE 2012/19/EU	
Odniesienia do odnośnych norm zharmonizowanych, które zastosowano lub do innych specyfikacji technicznych, w stosunku, do których deklarowana jest zgodność:	References to the relevant harmonised standards used or references to the other technical specifications in relation to which conformity is declared:	
LVD	PN-EN 61010-1:2011 PN-EN 61010-2-010:2020-10 PN-EN 60529:2003/A2:2014-07	
EMC	PN-EN IEC 61326-1:2021-10	
RoHS	PN-EN IEC 63000:2019-01	
Wodzisław Śl. 10.07.2024		Podpis / Signature:
		 Dawid Rybarz Dyrektor Techniczny (CTO)



DEKLARACJA ZGODNOŚCI UE
EU DECLARATION OF CONFORMITY



Produkt:	Product:
Szafa termostatyczna	Cooled incubator (ST)
Model:	Model:
ST 1; ST 2; ST 3; ST 4; ST 5; ST 6; ST 500; ST 700; ST 1200; ST 1450; ST 1/1; ST 1/1/1; ST 2/2; ST 2/3; ST 2/4; ST 3/3; ST2/ZLN85; ST3/ZLN85	
w wersjach:	in version:
C SMART; CS SMART; P SMART; PS SMART; CM SMART, CMS SMART; PM SMART; PMS SMART	
Nazwa i adres producenta:	Name and address of the manufacturer:
POL-EKO® A.Polok-Kowalska sp.k. ul. Kokoszycka 172 C, 44-300 Wodzisław Śląski Polska/Poland	
Niniejsza deklaracja zgodności wydana zostaje na wyłączną odpowiedzialność producenta.	This declaration of conformity is issued under the sole responsibility of the manufacturer.
Wymieniony powyżej przedmiot niniejszej deklaracji jest zgodny z odpowiednimi wymaganiami unijnego prawodawstwa harmonizacyjnego:	The object of the declaration described above is in conformity with the relevant Union harmonisation legislation:
LVD 2014/35/UE EMC 2014/30/UE RoHS 2011/65/UE & 2015/863UE WEEE 2012/19/UE	LVD 2014/35/EU EMC 2014/30/EU RoHS 2011/65/EU & 2015/863EU WEEE 2012/19/EU
Odniesienia do odnośnych norm zharmonizowanych, które zastosowano lub do innych specyfikacji technicznych, w stosunku, do których deklarowana jest zgodność:	References to the relevant harmonised standards used or references to the other technical specifications in relation to which conformity is declared:
LVD	PN-EN 61010-1:2011 PN-EN 61010-2-010:2020-10 PN-EN 60529:2003/A2:2014-07
EMC	PN-EN IEC 61326-1:2021-10
RoHS	PN-EN IEC 63000:2019-01

Wodzisław Śl. 10.07.2024

Podpis / Signature:

Dawid Rybarz
Dyrektor Techniczny (CTO)



DEKLARACJA ZGODNOŚCI UE
EU DECLARATION OF CONFORMITY



Produkt:	Product:
Urządzenia wielokomorowe i mieszane	Multi-chamber and mixed devices
Model:	Model:
ST1/1/1; ST1/1; ST2/2; ST2/3; ST3/3; ST2/4; CHL1/1/1; CHL1/1; CHL2/2; CHL2/3; CHL3/3; CHL2/4; ST1/CHL1; ST1/ST1/CHL1; ST1/CHL1/CHL1; ST2/CHL2; ST2/CHL3; CHL2/ST2; CHL2/ST3; ST3/CHL3; CHL3/ST3; ST2/ZLN85; ST3/ZLN85; CHL2/ZLN85; CHL3/ZLN85; ZLN85/85	
w wersjach:	in version:
C SMART; CS SMART; P SMART; PS SMART; CM SMART, CMS SMART; PM SMART; PMS SMART	
Nazwa i adres producenta:	Name and address of the manufacturer:
POL-EKO® A.Polok-Kowalska sp.k. ul. Kokoszycka 172 C, 44-300 Wodzisław Śląski Polska/Poland	
Niniejsza deklaracja zgodności wydana zostaje na wyłączną odpowiedzialność producenta.	This declaration of conformity is issued under the sole responsibility of the manufacturer.
Wymieniony powyżej przedmiot niniejszej deklaracji jest zgodny z odnośnymi wymaganiami unijnego prawodawstwa harmonizacyjnego:	The object of the declaration described above is in conformity with the relevant Union harmonisation legislation:
LVD 2014/35/UE EMC 2014/30/UE RoHS 2011/65/UE & 2015/863UE WEEE 2012/19/UE	LVD 2014/35/EU EMC 2014/30/EU RoHS 2011/65/EU & 2015/863EU WEEE 2012/19/EU
Odniesienia do odnośnych norm zharmonizowanych, które zastosowano lub do innych specyfikacji technicznych, w stosunku, do których deklarowana jest zgodność:	References to the relevant harmonised standards used or references to the other technical specifications in relation to which conformity is declared:
LVD	PN-EN 61010-1:2011 PN-EN 61010-2-010:2020-10 PN-EN 60529:2003/A2:2014-07
EMC	PN-EN IEC 61326-1:2021-10
RoHS	PN-EN IEC 63000:2019-01

Wodzisław Śl. 10.07.2024

Podpis / Signature:

Dawid Rybarz
Dyrektor Techniczny (CTO)



DEKLARACJA ZGODNOŚCI UE
EU DECLARATION OF CONFORMITY



Produkt:	Product:
Inkubator z chłodzeniem	Cooled incubator
Model:	Model:
ILW 53; ILW 115; ILW 240; ILW 400; ILW 750	
w wersjach:	in version:
SMART; IG SMART	
Nazwa i adres producenta:	Name and address of the manufacturer:
POL-EKO® A.Polok-Kowalska sp.k. ul. Kokoszycka 172 C, 44-300 Wodzisław Śląski Polska/Poland	
Niniejsza deklaracja zgodności wydana zostaje na wyłączną odpowiedzialność producenta.	This declaration of conformity is issued under the sole responsibility of the manufacturer.
Wymieniony powyżej przedmiot niniejszej deklaracji jest zgodny z odnośnymi wymaganiami unijnego prawodawstwa harmonizacyjnego:	The object of the declaration described above is in conformity with the relevant Union harmonisation legislation:
LVD 2014/35/UE EMC 2014/30/UE RoHS 2011/65/UE & 2015/863UE WEEE 2012/19/UE	LVD 2014/35/EU EMC 2014/30/EU RoHS 2011/65/EU & 2015/863EU WEEE 2012/19/EU
Odniesienia do odnośnych norm zharmonizowanych, które zastosowano lub do innych specyfikacji technicznych, w stosunku, do których deklarowana jest zgodność:	References to the relevant harmonised standards used or references to the other technical specifications in relation to which conformity is declared:
LVD	PN-EN 61010-1:2011 PN-EN 61010-2-010:2020-10 PN-EN 60529:2003/A2:2014-07
EMC	PN-EN IEC 61326-1:2021-10
RoHS	PN-EN IEC 63000:2019-01

Wodzisław Śl. 10.07.2024

Podpis / Signature:

Dawid Rybarz
Dyrektor Techniczny (CTO)

We produce:

- thermostatic cabinets
- laboratory refrigerators
- laboratory incubators
- devices with photoperiod and phytotron system
- drying ovens and sterilizers
- drying ovens with nitrogen blow
- laboratory freezers
- ultra-low freezers
- climatic chambers
- Caldera fluid and blanket warmers
- colony counters
- laboratory shakers
- stationary samplers
- Hydromat water dispensers
- Eurodrop stations
- FEKO+ waste water receipt station
- heating ovens
- cooled incubators
- fume hoods

We organize:

- regional trainings
- individual trainings
- seminars

We provide:

- warranty and post-warranty service
- consultancy in the selection, maintenance and operation of laboratory equipment

POL-EKO LAB is **Accredited by the Polish Centre for Accreditation (a member of ILAC)** and provides accredited calibration of:

- thermostatic and climatic chambers (incubators, drying ovens, thermostatic cabinets, climatic chambers, freezers)
- water baths and thermo reactors
- autoclaves
- electric and electronic thermometers
- data loggers
- high temperature laboratory furnaces
- thermohygrometers
- laboratory sieves

Calibration is confirmed with the issue of 'Calibration Certificate'.

Services outside the scope of accreditation:

- checking equipment for physicochemical measurements (meters and probes),
- carrying out IQ, OQ, PQ qualification procedures,
- mapping of temperature and humidity in the rooms

We offer portable, laboratory and on-line equipment:

- pH-meters
- ionmeters
- dissolved oxygen meters
- conductivity meters
- photometers and spectrophotometers
- thermo reactors
- turbidity metres
- pH electrodes
- conductivity sensors
- oxygen probes
- heavy metals trace analyzers
- water baths
- autoclaves
- pH buffer solutions
- conductivity standards
- photometric tests
- laboratory accessories
- consumables



AP 115

Manufacturer of control and measurement equipment for laboratory tests and technological processes, distributor in Poland of the following companies: HAMILTON, THERMO SCIENTIFIC, WTW, XYLEM



POL-EKO®

(+48) 32 453 91 70
info@pol-eko.com.pl
www.pol-eko.com.pl

POL-EKO® A. Polak-Kowalska sp.k.
44-300 Wodzisław Śląski
ul. Kokoszycka 172 C