

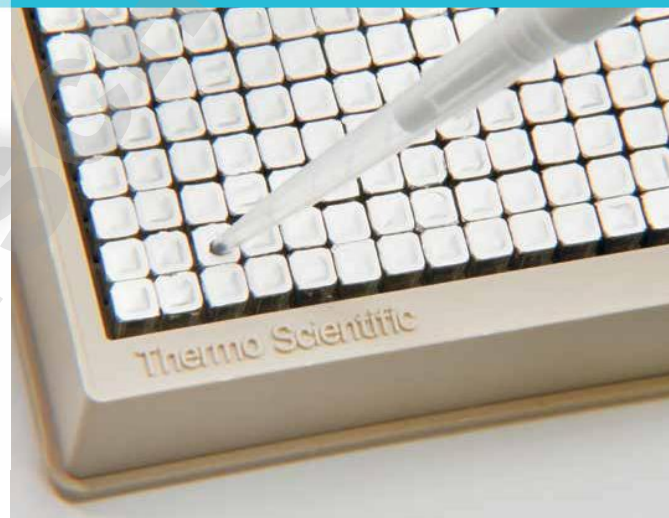

Thermo Scientific  
Automated Sample Storage Resource Guide



proven solutions

to preserve samples

DOMINIQUE DUTTO

**Thermo**  
SCIENTIFIC

## ensuring sample integrity



Sample storage at cryogenic and extremely low temperatures provides security for biological specimens and derivatives of those specimens, genomic material, and compounds over extended periods of time. Because of the valuable or irreplaceable nature of these samples being stored, it is critical to ensure that they are adequately protected from the harsh storage environment and during handling processes.

While an individual storage tube's features appears simple, there are several factors to consider when determining the suitability of a storage tube for your precious samples.

### Recommended:

- > Prevent sample loss and contamination using a tube whose cap includes a soft, durable gasket
- > Protect samples by choosing a tube with robust construction and proven capping or sealing solutions that resist physical damage
- > Ensure maximum sample recovery with plastics that exhibit low protein and DNA binding performance

## ensuring sample identity



### Preserving the information associated with stored samples

is a critical part of the storage process, as unidentified samples in storage are unusable and serve no purpose. 2D barcoding is an effective method often employed to track sample ID and other associated information. The readability of the 2D barcode contributes to sample credibility and efficiency of the storage workflow. Selecting the best 2D barcode reader is also important, depending on the number and format of tubes you will be scanning. Selecting the best software for sample tracking is key and growth of the collection over time must be considered.

### Recommended:

- > Use tubes that have a permanent 2D barcode to ensure that samples will be identifiable when retrieved months or years in the future
- > Select a tube with a high-contrast barcode that can be read through frost and ice when removed from storage
- > Select barcoding that is resistant to chemical and physical damage

# Table of Contents

## Thermo Scientific Products for Automated Sample Storage

### 1 Collect page 8

Matrix and Nunc Universal Storage Tubes  
Nunc CryoBank Tubes

### 2 Seal page 10

Caps for Matrix and Nunc ScrewTop Tubes  
Automated Cappers/Decappers  
Handheld Cappers/Decappers  
SampleSeal Sealing Instrument  
Matrix SepraSeal Mats  
Matrix DuraSeal Mats

### 3 Label page 11

Matrix Side Printed Tubes

### 4 Track page 14

VisionTracker Database Software  
VisionMate Full Rack 2D Readers  
VisionMate Single Tube 2D Readers  
SampleArray Tube Handler

### 5 Store page 17

Universal Latch Racks

### 6 Full Product List page 18

Complete product listing charts

## One set of tools for all your tubes

While all Thermo Scientific™ sample storage products ensure safety and security for your samples, many of our products work even better when used together.

### Enter the Thermo Scientific™ Universal™ System

Historically, tubes, caps, and the boxes and racks they're placed in have come in various shapes and sizes, requiring a multitude of processing equipment — pipettors, decappers, sealers, etc. The result is an unscalable workflow.

With the Universal System, you only need a single, universal set of processing tools whether you run a small academic laboratory or a large commercial one. Throughout the Sample Storage workflow, you'll find products within the Thermo Scientific™ Universal™ System.



### Look for the red check.

When you see the red check, you'll know right away that the product is scalable and designed for automation use. Keep an eye out for it throughout this brochure and anywhere you see Thermo Scientific Sample Storage products.

## Thermo Scientific Universal Tubes

**Square Cap Interface:** Enables use of same tools with entire portfolio of Universal tubes

**9mm Spacing:** All tubes spaced in Universal Rack in multiples of 9mm per ANSI standard, so same multi-channel tools work for all racked tubes

### 0.2 mL Tubes

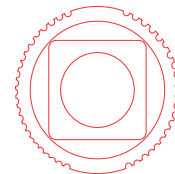
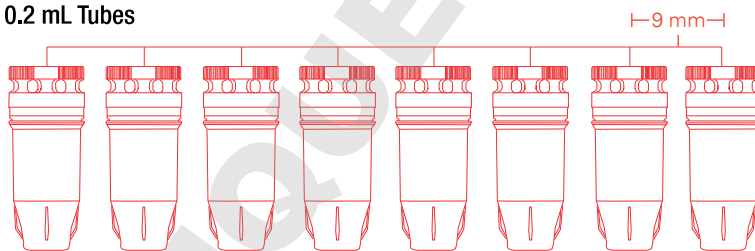

Universal Cap (Top View)

### 1.8 mL Tubes

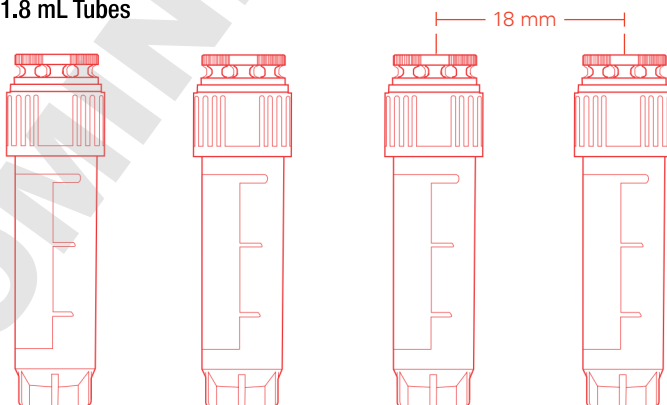

## Thermo Scientific Universal Tubes (continued)

**Anti-rotation Design:** Holds tubes in place for one-handed capping or decapping with tools

**Available Blank or with 2D Barcode:** Tubes with white patch and graduations in two formats, so users can easily move from blank to 2D using the same tools

**Universal Rack or CryoBox Fit:** For storage in either desired format

**Molded-in Cap Gasket:** Easy to close without over-tightening by hand or with tools and maintains sample security at a wide range of temperatures

**High-contrast, Non-proprietary 2D Datamatrix:** Code format can be read on same readers for all tubes and is robust enough for a lifetime of identification

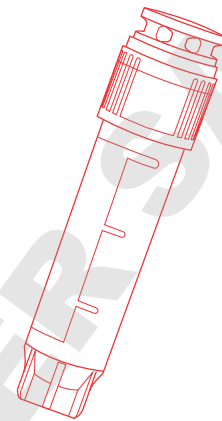

Universal Tube

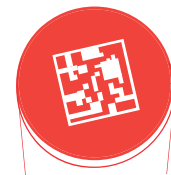

2D Datamatrix (tube bottom)

## Thermo Scientific Universal Latch Racks

**Locking Lid:** Enables secure storage of tubes in rack with no chance for them to fall out during transport, accidental drops, etc.

**Lifting Lid:** Allows robotics to pick/place the lid for removal in automated systems

**Pivoting Lid:** Prevents potential lid contamination during manual pipetting, by eliminating contact with the benchtop

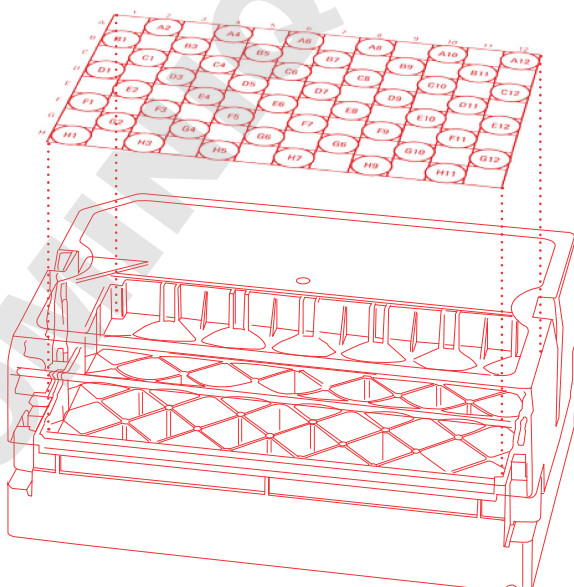

Universal Latch Rack (closed lid)

# Sample Storage Workflow

This diagram shows some of the most popular products in the Thermo Scientific Sample Storage workflow. Although all products within our Sample Storage portfolio provide superior protection, the products shown in red are part of the Universal System.

## 1 Collect

Thermo Scientific™ Matrix™ Storage Tubes  
Thermo Scientific™ Nunc™ Universal Storage Tubes  
Thermo Scientific™ Nunc™ CryoBank™ Tubes

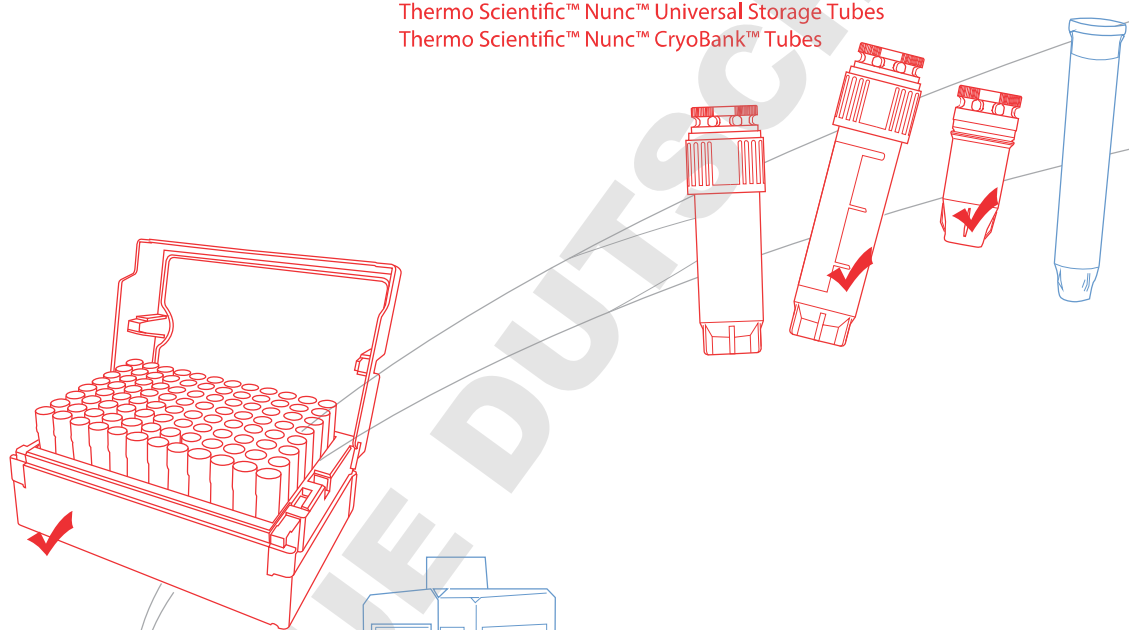

## 5 Store

Universal Latch Racks  
Microplate Footprint Racks  
Freezer Racks

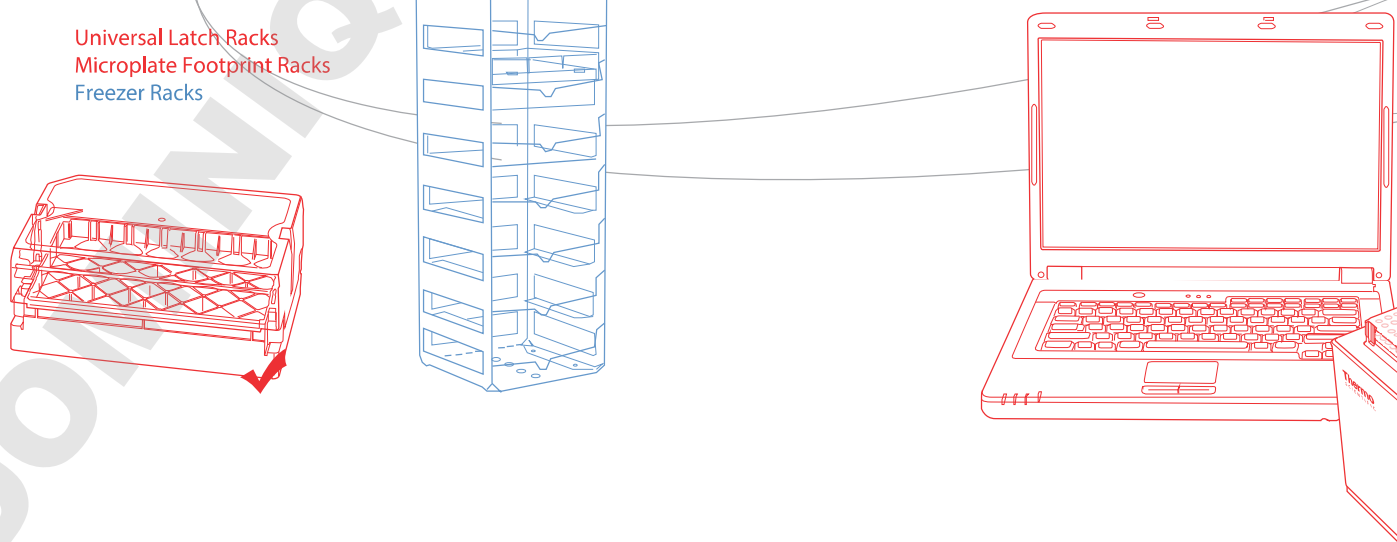

## 2 Seal

- Caps for Matrix and Nunc ScrewTop Tubes
- Automated Cappers/Decappers
- Handheld Cappers/Decappers
- Thermo Scientific™ SampleSeal™ Sealing Instrument
- Thermo Scientific™ Matrix™ SepraSeal™ Mats
- Thermo Scientific™ Matrix™ DuraSeal™ Caps

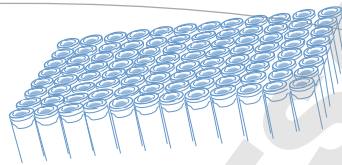
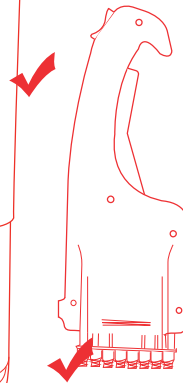
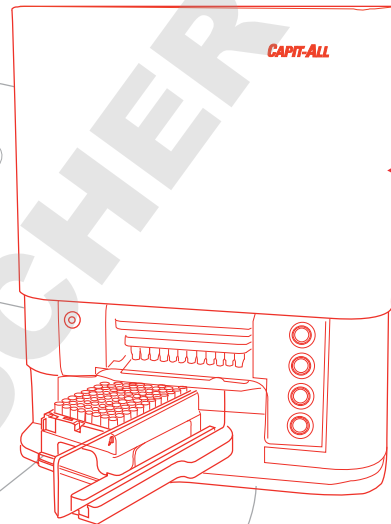
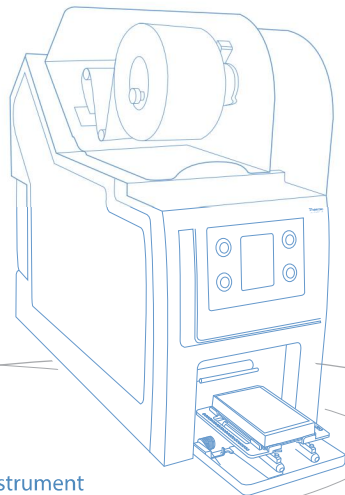

## 3 Label

Matrix Side-Printed Tubes

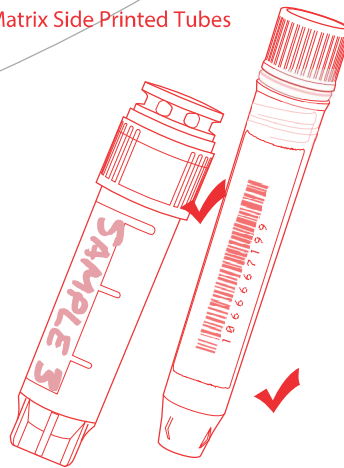

## 4 Track

- Thermo Scientific™ VisionTracker™ Database Software
- Thermo Scientific™ VisionMate™ Full Rack 2D Readers
- VisionMate Single-Tube 2D Readers

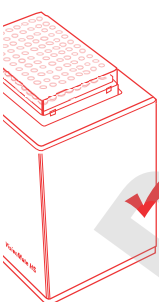

# Collect

Start by selecting the proper storage tube for your sample. We make it easy for you with a wide choice of tubes to start with, and a large assortment of seals, racks and tools for tracking and processing your important samples.

## Thermo Scientific Matrix and Nunc 2D Storage Tubes

When your workflow includes semi-automated and fully-automated platforms for high throughput, Thermo Scientific™ tubes allow robust storage and tracking of sample volumes ranging from 70  $\mu$ L to 12 mL in 384-, 96-, 48- and 24-place arrays. We have storage formats available for temperatures down to VPLN, and multiple sealing options including ScrewTop caps and septa seals. Solid, one-piece construction means there are no labels to fall off and tubes made from medical-grade resins are supplied free of RNase, DNase, endotoxins and cytotoxins and SAL down to  $10^{-6}$ .

### Thermo Scientific™ Matrix™ Storage Tubes

#### Recommended Usage:

- > Ideal for high throughput storage with automation friendly design features
- > Processes which require shipments of samples to other sites requiring human readable labeling benefit from tubes with smooth sides
- > Screw cap tubes with volumes down to 200  $\mu$ L enable small volume storage which support maximizing storage space
- > Tubes with pierce-able seals for simple downstream sample access
- > Small volume 384 tubes ideal for single use biological and other genomic applications to prevent freeze/thaw cycles
- > Available in Amber for storage of light sensitive material
- > Range of cap color options for quick sample identification

Matrix storage tubes feature high-contrast laser-etched 2D barcodes and standard microplate-format racks. Compatible with the complete line of 2D barcode readers, capping/decapping and arraying equipment, Matrix tubes are suited to benchtop and high-throughput applications.

Available in Latch Racks, specially-designed, stackable racks with a microplate footprint

-20°C  
-80°C  
VPLN



Designed for automated systems including liquid handling, decappers and other automated platforms

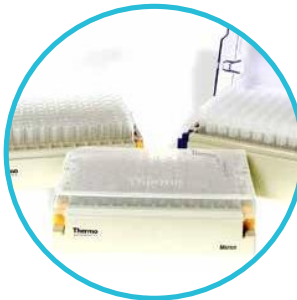

Matrix tubes are 100% leak tested to ensure tube integrity and sample security



Rack base and tube design prevents the tube from spinning in the rack when decapping whether single tube hand decapping or, multi channel automated decapping



Laser-etched 2D barcode on the base of every tube ensures secure sample tracking with highest contrast available for readability even with some frost on the tube

Thermo Scientific™  
VisionMate™ Barcode Readers  
Scan 2D barcoded storage tubes to easily track and manage sample data  
see page 14





## Thermo Scientific™ Nunc™ CryoBank™ Tubes ✓

### Recommended Usage:

> Choose for the locking rack when benchtop use and frequent lab movement is required

Nunc CryoBank storage tubes are ideal for users who need locking tubes that are not going to fall out during frequent movement and use without a rack lid. Trust Nunc storage tubes for ultra low temperature storage down to the vapor phase of liquid nitrogen.

# VPLN

**Screw Cap** with integrated gasket ensures a tight seal every time and compatible with storage across a range of temperatures.



**ScrewTop** can be resealed numerous times with no effect on sealing integrity and can be stored down to the vapor phase of liquid nitrogen

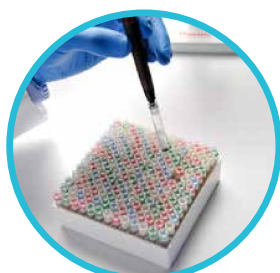

**Same box, double the storage capacity.**

169 1.0 mL Nunc CryoBank tubes fit into a standard Thermo Scientific™ CryoBox™ with a 13 x 13 divider. See Dense Storage Option, see the Cryostorage Products Guide.



**Laser-etched 2D barcode** on the base of every tube ensures secure sample tracking with the highest contrast code available for reading even with some frost on the tubes

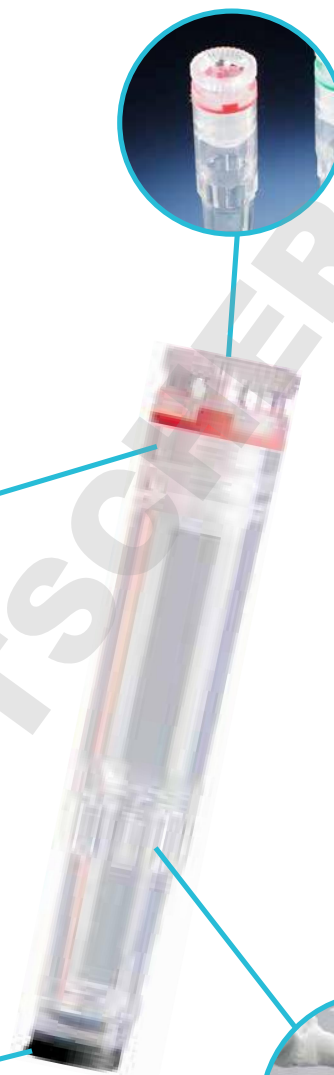

**Locking rack** enables frequent movement around the lab without tubes falling out, even when rack is held upside down and anti-rotation features prevent tubes from spinning during capping and decapping

## What's New in tubes

Find catalog numbers for Nunc CryoBank and Matrix Storage Tubes on page 18-21.

This is a truly universal product line, with caps, tubes and racks compatible with decappers, liquid handlers and any equipment or racking that handles microplate-footprint storage. The products still allow the flexibility of septa, heat sealing or screw-top closure depending upon the need.

For more information on Cappers/Decappers see page 10.  
For more information on Racks see page 17.

There are a number of innovative ways to seal Thermo Scientific™ Matrix™ and Nunc™ cryo tubes. Here you will find our full range of sealing solutions and some helpful hints for choosing the best sealing option for your application.

## Thermo Scientific Matrix and Nunc Tube Sealing Solutions

Thermo Scientific™ SepraSeal™ and DuraSeal™ tube sealing solutions complement the innovative line of Matrix 2D-coded and non-coded storage tubes. ScrewTops available on Matrix 2D and Nunc CryoBank™ round out the options. Use with automated liquid handling, screwtop decappers and other automated platforms.

### Caps for Matrix and Nunc ScrewTop Tubes ✓

Recommended Usage:

- > **Ideal for storage from -80°C to VPLN for biological extracts and cell storage**
- > **Screw Caps are necessary for applications where disposable liquid handling tips are used so that caps can be easily removed and reinstalled with decappers**

- Colored caps available for both Matrix and CryoBank tubes
- O-rings or integrated gaskets ensure tight seal
- ScrewTop closures are compatible with automated decappers

### Handheld Cappers/Decappers ✓

Recommended Usage:

- > **When using multi-channel pipettes to dispense biological samples or extracts into tubes**
- > **When necessary to add columns of specific colored caps as a control or standard during analysis or to identify different types of biological samples in storage or in kits**

With the Thermo Scientific 8-Channel Screw Cap Capper/Decapper you can process a rack of Matrix or Nunc CryoBank tubes in less than a minute. The 8-Channel Screw Cap Decapper ergonomically and efficiently uncaps eight samples at one time.

#### 8-Channel capper/decapper

Speeds sample processing, Ensures reproducibility and has an ergonomic design



**Intuitive design** for easy push-button cap and decap operation and easy-to-press cap ejector



**Process 8 caps at a time**  
Convenient when using colors to identify samples



**Faster and more ergonomic** than hand decapping



## Automated Cappers/Decappers ✓

### Recommended Usage:

- > ScrewTop tube use in biological storage
- > When decapping in a larger, integrated storage system and walk-away capability is required
- > When used with 96-way liquid handling for creating mother/daughters in biological or genomic applications

The Thermo Scientific™ Capit-All™ capper/decapper automatically removes and replaces caps on tubes of differing heights, even in the same rack, as well as tubes not properly seated in racks. The Capit-All IS unit is easily integrated with automated liquid handling instrumentation. It is easy to operate, requires no training, and is designed to extend tube life.

- Ensures that racks are loaded in the correct orientation
- Prevents cross-threading or overtightening of caps
- Special design eliminates distortion and damage to caps, even after repeated use
- Integrated automated drip tray and vacuum extraction port reduce risk of contamination
- Compatible with Matrix and Nunc ScrewTop storage tubes



### Capit-All Capper/Decapper

Caps and uncaps 24-, 48- and 96-format Matrix and Nunc ScrewTop tubes

**Increases laboratory throughput** and improves ergonomics by replacing cumbersome handwork with rapid decapping and capping of 96 tubes at once (in approximately 10 seconds per rack)

**Drip tray prevents cross contamination** of samples during placement and removal of tube racks.

## Thermo Scientific™ SampleSeal™ Tube Sealer

### Recommended Usage:

- > Thermally seals and individualizes storage tubes for high integrity storage down to VPLN and high density storage formats

The SampleSeal instrument thermally applies and cleanly individualizes Thermo Scientific 96- and 384-format storage tubes for a low profile and high integrity storage format for storage applications down to -196°C.

- Seals and individualizes fully populated tube racks in under 60 seconds to accommodate a range of throughput requirements for standalone benchtop and integrated use
- Applies pierceable foil seals that can be accessed by manual or automated pipetting instruments for single access sample applications
- Sealed tubes are IATA certified for transportation



## What's New in seals

Maximize storage capacity with individually-sealed 96- and 384-format tubes with pierceable foil seals. The space conserved with the high-density 384-tube storage format conserves energy required by additional laboratory freezers

Many screw caps are available pre-racked and compatible with various capping/decapping equipment.

## Thermo Scientific™ SuperSealer™ Sealing Instrument

### Recommended Usage:

- > For consistent, secure, proper application of SepraSeal CapMat sealing options

Choose individual sealing options such as SepraSeal caps for liquid handling and single tube accessibility or seal entire plates and blocks for long term storage with CapMat.

- Simplifies the sealing of plates, blocks and tube racks of virtually any height, with no adjustments needed, ensuring a secure and consistent seal
- Load the tubes and seals, close the door, and the SuperSealer instrument does all the work ergonomically and fast

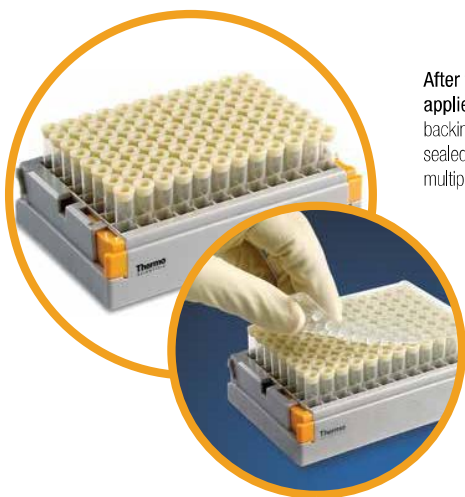

After the SuperSealer instrument applies the mat, simply pull up the backing sheet to reveal 96 individually sealed tubes—for applications where multiple piercings are required



## SepraSeal Mats

### Recommended Usage:

- > SepraSeal caps are ideal for piercing/access required for compound storage
- > For powdered compounds requiring dissolution and then cap installation

SepraSeal mats provide a secure seal for Matrix 2D-coded and non-coded storage tubes down to  $-80^{\circ}\text{C}$ . Available in different formats and colors, SepraSeal mats are supplied in arrays of 96 that can be applied to seal an entire tube rack. Sealing is secure and consistent every time when applied with the SuperSealer automatic sealer.

- Advanced thermoplastic elastomer minimizes evaporation and water uptake in DMSO-based samples
- SepraSeal mats are available sterile or non-sterile, solid or pre-split, in a range of colors for quick visual sample identification
- Solid seals can be removed for sample access with the SepraSeal cap removal tool, or can be pierced once



SepraSeal caps are designed to effectively seal tubes for long term storage while remaining pierceable and removable

## DuraSeal Mats

### Recommended Usage:

- > Durable DuraSeal caps are ideal for samples requiring hundreds of piercings in compound storage
- > Excellent for fixed-tip applications that can fill tubes with pre-installed seals so that DMSO water adsorption is minimized

The DuraSeal capping system provides a permanent seal for Matrix 2D-coded or non-coded storage tubes and can be used for storage down to temperatures of  $-80^{\circ}\text{C}$ .

- Self sealing design maintains sample integrity and prevents loss during storage
- Capping system is available bulk or pre-installed in many of our storage tubes

Even with linear barcoding and 2D barcodes, human-readable text is sometimes still required to identify samples.

## Thermo Scientific™ Matrix™ Side Printed Tubes

### Recommended Usage:

- > Side printing is ideal when collaborators or other labs within your facility cannot read 2D and require human readable or linear barcoding
- > Clinical research trials, shipment of samples to customers or collaborators or up/down stream processing where 2D reading is not readily available
- > Tubes with the white patch are perfect when used with laboratory markers and cryopens

Matrix 2D Barcoded ScrewTop storage tubes are now available pre-printed with 1D and human-readable codes that match the tube's 2D code. This side pre-printed option eliminates the need for secondary printing or application of paper labels. 1D and human-readable codes are printed in high-contrast black on white and allow easy visual identification or 1D barcode scanning. The white patch option allows custom information to be written on the tube via manual or automated methods. These new pre-labeled options can enhance a range of laboratory workflows, especially across multiple sites.

- The linear and human readable codes match this unique 2D barcode, allowing 1D scanning or visual identification of samples across satellite or collaborative sites without 2D readers
- 2D barcode features and tube features found in our standard Matrix ScrewTop tubes

### Compatible

Thermo Scientific 2D and 1D barcode reader options scan and instantly decode each tube's barcode into any application or database. See page 14



Compatibility with existing ScrewTop tube storage systems and accessories



The linear and human readable codes match this unique 2D barcode, allowing 1D scanning or visual identification of samples across satellite or collaborative sites without 2D readers

## What's New in labeling

Side printed tubes enable wider use of the tubes without hand labeling! Look for catalog numbers ending in WP1D for Side Printed Tubes on page 18.

# Track

Our line of Thermo Scientific™ VisionMate™ Barcode Readers is compatible with Thermo Scientific™ Nunc™ and Matrix™ tubes. Add the Thermo Scientific™ VisionTracker™ database and you have the full solution to track your samples from receipt in the biobank through disposition to customers.

## VisionTracker Database Software

Recommended Usage:

- > For storage libraries that have grown beyond the laboratory notebook or homegrown spreadsheet to track, locate and optimize storage
- > Basic tracking of samples in non-barcoded or barcoded storage tubes
- > Tracking of samples read with VisionMate barcode readers

VisionTracker software provides an intuitive and secure database for storing your precious sample data and corresponding sample locations. Whether storing in linear barcoded cryotubes, 2D barcoded tubes, or other storage vessels, VisionTracker software can help to easily organize and track your samples. VisionTracker is ideal for use with the VisionMate reader portfolio for seamless integration of linear or 2D barcode data.

- Replaces a notebook or basic Excel™ spreadsheet at your lab bench
- The database is icon-based and includes straightforward searching: sample addition, mother-to-daughter aliquotting and sample disposition
- VisionTracker software conforms to CFR 21 Part 11, allows administrator and user-level access, and maintains chain-of-custody history
- Standard audit history tools facilitate secure tracking of sample information and location throughout the life of the sample
- 12-month support contract includes downloadable VisionTracker database enhancements and upgrades

VisionTracker software is pre-programmed for use with Thermo Scientific cryogenic and 2D barcoded consumables, compatible boxes, and Thermo Scientific freezers, providing easy setup and configuration



**Built-in functionality** for direct reading via VisionMate barcode readers. Reader interfaces can easily be integrated to simplify management and tracking of barcoded samples

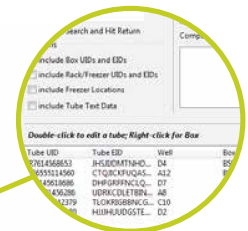
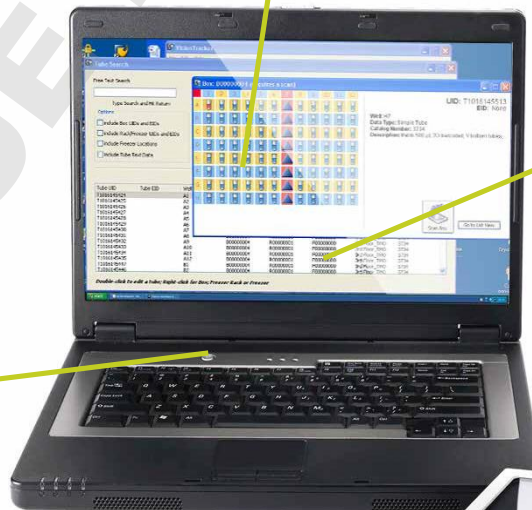

Data can be easily searched and queried across broad or specific criteria. Samples can be easily transferred to a picklist for manual or automated processing



## VisionMate Full Rack 2D Readers

### Recommended Usage:

- > Higher throughput applications requiring input of full racks of 2D tubes at one time
- > VisionMate SR Reader serves cost-conscious applications where high speed is not necessary, but full rack reading is required for entry into databases or LIMS
- > VisionMate HighSpeed Reader provides solutions for laboratories requiring cold-storage reading or speed, such as use in large storage systems so tubes do not have to be removed

VisionMate High Speed 2D barcode readers rapidly decode a single tube or a full rack of tubes. VisionMate SR 2D Barcode Reader decodes a full rack of barcoded storage tubes in less than ten seconds. Compact, user-friendly readers provide exceptional flexibility with data export formats, tube type readability and tube layout options.

## VisionMate High Speed Single Rack Reader

### Speed and Versatility

- Controlled via the onscreen software interface provided, or remotely via TCP/IP connection
- Robust optics and automation-friendly design, including recessed lid corners for better robotic placing; ideal for high throughput operations
- Using the 1D accessory for the VisionMate High Speed reader, read linear labels on the sides of storage tube racks simultaneously
- Single camera enables image file save ability
- Lights illuminate only during use to conserve energy

### Compatible with Storage Conditions

- Operating down to  $-40^{\circ}\text{C}$ , these readers preserve sample integrity by enabling barcode reading in your cold room or large, low-temperature liquid storage device
- Sealed VisionMate HighSpeed units prevent frost and condensation buildup to allow instant reading of ice-cold tubes at ambient temperatures

### Data File Flexibility

- Easily integrated into LIMS, existing databases or tracking systems, choose the data format for export and with optimized software, conserve memory space
- User-defined code types and lengths indicate incorrect codes and limit access by user profile



**VisionMate HS high speed 2D barcode reader** rapidly decodes 2D barcoded storage tubes with both single tube and full rack capabilities



**Decodes all standard** Thermo Scientific 2D barcoded storage tubes as well as virtually any other 2D barcode with ease

## VisionMate SR Single Rack Reader

- Lower cost alternative when VisionMate HighSpeed features such as speed, operation to  $-40^{\circ}\text{C}$ , 1D barcode reading capability, etc., are not required
- Scans a full tube rack in less than ten seconds
- Simply follow the instructions during software installation and connect the reader to a computer via USB port
- Integrates easily with LIMS, existing databases or tracking systems
- Small footprint and compact profile save valuable laboratory space



Controlled via on-screen software interface or remotely via TCP/IP connection



## VisionMate SR Single Rack 2D Barcode Reader

Compact, user-friendly reader provides exceptional flexibility with data export formats, tube type readability and tube layout options



### Innovative Storage

The Thermo Scientific™ Universal™ Latch Rack uses the 48- and 96-well format and works seamlessly with VisionMate readers, see page 17 for more information

## Thermo Scientific™ VisionMate™ Single Tube 2D Reader

### Recommended Usage:

- > A single tube reader may be employed to read individual barcoded tubes when full racks are not required in lower throughput or up/downstream applications
- > VisionMate ST is a great, low cost alternative for labs just starting in 2D or requiring many readers throughout the lab at various workstations for managing tube movement

VisionMate ST 2D Barcode Reader is a compact single-tube reader for scanning 2D barcoded tubes into virtually any application. Plug the unit into an available USB port and allow the drive to automatically install. Hold any Thermo Scientific 2D barcoded storage tube over the scanning window to decode the barcode instantly.



**Simply plug into any USB port.**  
Hold any Thermo Scientific 2D barcoded storage tube over the scanning window to decode the barcode instantly.

**Scans a single 2D barcoded**  
storage tube so sample data and location can be easily tracked and managed. Laser-etched 2D barcode on the base of every tube allows secure sample identification and tracking.



## Thermo Scientific™ SampleArray™ Tube Handler

### Recommended Usage:

- > Re-array 2D barcoded tubes in 48, 96, and 384 format for downstream sample processing and assays
- > Easily and simply compile target samples into condensed racks
- > Re-array in temperatures as low as -20°C to minimize sample exposure to thawing conditions

The SampleArray Tube Handler provides a quick and easy solution for arraying sample tubes in 48-, 96-, or 384-format racks for storage tube processing. Compatible with applications that require sample handling down to -20°C, this instrument can transport individual tubes without thawing precious samples. A valuable add-on to the Thermo Scientific™ SampleSeal™ tube sealer or Thermo Scientific™ Capit All™ capper, the SampleArray instrument completes a secure sealing and arraying process that can benefit a range of sample storage and handling requirements.

- Intuitive software interface allows end user to generate picklists quickly and easily and set quarantine conditions per run
- Integrated 2D barcode reader and weigh station module accessory to track sample volume
- Compatible with multiple tube and sealing formats for flexibility across a range of storage procedures



## What's New in readers

Readers can be easily integrated and used with VisionTracker software! Find catalog numbers for VisionMate Barcode Readers, Wireless Readers and tracking software on page 23.

Whether in 96-way, 48-way honeycomb, or any other iteration, the Thermo Scientific range of readers can read all the tubes right in the rack. Integrate with VisionTracker software and storing sample data becomes a breeze.



You can achieve secure sample storage while maximizing freezer space using Thermo Scientific™ storage solutions. From microplate-footprint tube racks for automation to dense storage boxes that double your capacity, we have solutions for virtually every storage application.

## Thermo Scientific™ Universal™ Latch Racks

### Recommended Usage:

- > Ideal for high throughput customers looking for automation friendly format racks for their larger tubes in biological storage
- > The rack design also enables alignment of standard cryogenic storage formats with microplates and other tubes such as 2D so the same racks can be used
- > Same racks that are available on Thermo Scientific™ Matrix™ Storage Tubes

The Universal Latch Rack features an ANSI standard microplate footprint that holds 48 internally threaded or 24 externally threaded traditional Thermo Scientific™ Nalgene™ or Nunc™ CryoTube™ vials. Use the pivoting lid on the bench or lock it for transport so tubes never fall out. The format facilitates use in automated picking/placing, liquid handling and other high throughput applications.

### Innovative Storage Technologies

The Universal Latch Rack is ideal for storing traditional cryostorage tubes at temperatures down to the vapor phase of liquid nitrogen. The footprint allows you to store tubes in the same format as microplates, 96-way 2D tubes, and other ANSI footprint storage, so racking and handling are streamlined.

### Universal Implementation

Regardless of which Thermo Scientific tubes you use, the Universal Latch Rack allows you to standardize across your entire workflow.

### Scalable

When processes scale up, the lid lifts off for easy automated picking and placing of tubes and moving racks in automated stores.

The lid pivots to rest open so it doesn't touch the bench while you remove tubes or do pipette work



The lockable latches prevent tubes from falling out during transport or accidental dropping



## What's New in storage

Universal Racks enable standardized storage for all tubes! Find catalog numbers for Latch Racks on page 23.

With the new Universal Latch Rack for standard CryoTubes, you can store your legacy samples in the same microplate footprint as your other Matrix and Thermo Scientific™ Nunc™ Cryo-Bank™ storage tubes.

## Collect

## Thermo Scientific™ Matrix™ 2D Barcoded Storage Tubes in Latch Racks

Cat. No.	Size, mL	Thread Style/Closure	Bottom Style	Marking	Sterile	Tube Color	Cap Color	Quantity	
								Rack	Case
<b>0.2 mL Universal ScrewTop Tubes in Latch Rack</b>									
3748	0.2	internal	V	barcode	yes	clear	clear	96	480
<b>0.5 mL Matrix ScrewTop Tubes in Latch Racks</b>									
3744	0.5	internal	V	barcode	yes	clear	clear	96	480
3744-WP*	0.5	internal	V	barcode	yes	clear	clear	96	480
3744-WP1D**	0.5	internal	V	barcode	yes	clear	clear	96	480
3744BLU	0.5	internal	V	barcode	yes	clear	blue	96	480
3744GRE	0.5	internal	V	barcode	yes	clear	green	96	480
3744PUR	0.5	internal	V	barcode	yes	clear	purple	96	480
3744RED	0.5	internal	V	barcode	yes	clear	red	96	480
3744WHI	0.5	internal	V	barcode	yes	clear	white	96	480
3744YEL	0.5	internal	V	barcode	yes	clear	yellow	96	480
3743AMB	0.5	internal	V	barcode	yes	amber	red	96	480
3745	0.5	internal	V	barcode	yes	clear	no cap	96	480
3745AMB	0.5	internal	V	barcode	yes	amber	no cap	96	480
3745-WP	0.5	internal	V	barcode	yes	clear	no cap	96	480
3745-WP1D	0.5	internal	V	barcode	yes	clear	no cap	96	480
<b>1.0 mL Matrix ScrewTop Tubes in Latch Racks</b>								<b>Rack</b>	<b>Case</b>
3741	1.0	internal	V	barcode	yes	clear	clear	96	480
3741-WP*	1.0	internal	V	barcode	yes	clear	clear	96	480
3741-WP1D**	1.0	internal	V	barcode	yes	clear	clear	96	480
3741BLU	1.0	internal	V	barcode	yes	clear	blue	96	480
3741GRE	1.0	internal	V	barcode	yes	clear	green	96	480
3741PUR	1.0	internal	V	barcode	yes	clear	purple	96	480
3741RED	1.0	internal	V	barcode	yes	clear	red	96	480
3741WHI	1.0	internal	V	barcode	yes	clear	white	96	480
3741YEL	1.0	internal	V	barcode	yes	clear	yellow	96	480
3741AMB	1.0	internal	V	barcode	yes	amber	red	96	480
3742	1.0	internal	V	barcode	yes	clear	no cap	96	480
3742-WP	1.0	internal	V	barcode	yes	clear	no cap	96	480
3742-WP1D	1.0	internal	V	barcode	yes	clear	no cap	96	480
3742AMB	1.0	internal	V	barcode	yes	amber	red	96	480
<b>12.0 mL Matrix ScrewTop Tubes in Latch Racks</b>								<b>Rack</b>	<b>Case</b>
3775	12.0	internal	V	barcode	yes	clear	solid	24	96
3778	12.0	internal	V	barcode	yes	clear	-	24	96
<b>Manual Screwdriver Compatible with Matrix Screwtop Storage Tubes</b>								<b>Rack</b>	<b>Case</b>
22176	-	-	-	-	no	black	-	1	1

\*WP = Matrix Side Printed Tubes with white patches for marking

\*\*WP1D = Matrix Side Printed Tubes with white patches; linear barcode

## Matrix 2D Barcoded Storage Tubes

Cat. No.	Size, mL	Thread Style/ Closure	Bottom Style	Marking	Sterile	Tube Color	Cap Color	Quantity
<b>0.2 mL Universal ScrewTop Tubes, in bulk</b>								<b>Case</b>
3747	0.2	internal	V	barcode	yes	clear	clear	480
<b>0.5 mL Matrix ScrewTop Tubes, in bulk</b>								<b>Case</b>
3743	0.5	internal	V	barcode	yes	clear	clear	480
3743BLU	0.5	internal	V	barcode	yes	clear	blue	480
3743GRE	0.5	internal	V	barcode	yes	clear	green	480
3743PUR	0.5	internal	V	barcode	yes	clear	purple	480
3743RED	0.5	internal	V	barcode	yes	clear	red	480
3743WHI	0.5	internal	V	barcode	yes	clear	white	480
3743YEL	0.5	internal	V	barcode	yes	clear	yellow	480
3743-WP1D	0.5	internal	V	barcode	yes	clear	clear	480
<b>1.0 mL Matrix ScrewTop Tubes, in bulk</b>								<b>Case</b>
3740	1.0	internal	V	barcode	yes	clear	clear	480
3740BLU	1.0	internal	V	barcode	yes	clear	blue	480
3740GRE	1.0	internal	V	barcode	yes	clear	green	480
3740PUR	1.0	internal	V	barcode	yes	clear	purple	480
3740RED	1.0	internal	V	barcode	yes	clear	red	480
3740WHI	1.0	internal	V	barcode	yes	clear	white	480
3740YEL	1.0	internal	V	barcode	yes	clear	yellow	480
3740-WP1D	1.0	internal	V	barcode	yes	clear	clear	480
<b>12.0 mL Matrix ScrewTop Tubes, in bulk</b>								<b>Case</b>
3770	12.0	internal	V	barcode	yes	clear	solid	100

## Find the right tube

We provide the largest selection of sample storage tubes and accessories with choices and options for every application. Contact one of our specialists if you need expert guidance or a recommendation.

Call +1 800-625-4327 or visit:  
[www.thermoscientific.com/samplestorage](http://www.thermoscientific.com/samplestorage)

## Matrix 2D Barcoded Storage Tubes (open top)

Cat. No.	Size, mL	Thread Style/ Closure	Bottom Style	Marking	Sterile	Pre-installed DuraSeals	Quantity	
							Rack	Case
<b>Matrix Storage Tubes in 96-Place Latch Racks</b>								
3734	0.5	septa	V	barcode	no	no	96	960
3735	0.5	septa	V	barcode	yes	no	96	960
3736	0.5	septa	V	barcode	no	yes	96	960
3737	0.5	septa	V	barcode	yes	yes	96	960
3750	0.5	septa	V	barcode	no	no	-	960
3729	0.75	septa	V	barcode	yes	yes	96	960
3731-11	0.75	septa	V	barcode	no	no	96	960
3732	0.75	septa	V	barcode	yes	no	96	960
3850	1.0	septa	V	barcode	no	no	96	480
3711	1.4	septa	flat	barcode	no	no	96	960
3712-11	1.4	septa	flat	barcode	yes	no	96	960
3713	1.4	septa	flat	barcode	no	no	96	960
3714	1.4	septa	flat	barcode	yes	yes	96	960
3790	1.4	septa	V	barcode	no	no	-	1000
3791	1.4	septa	V	barcode	no	no	96	960
3792	1.4	septa	V	barcode	yes	no	96	960
3794	1.4	septa	V	barcode	no	no	96	960
3801	1.4	septa	V	barcode	no	yes	96	960
<b>Matrix Storage Tubes, in bulk</b>								
3710	1.4	septa	flat	barcode	no	no	-	1000
3730-11	0.75	septa	V	barcode	no	no	-	1000
<b>Matrix Storage Tubes in 384-Place Racks</b>								
3815	0.1	seal	flat	barcode	no	no	384	7680

# Full Product List

## Collect

### Matrix 2D Storage Tubes (open top)

Cat. No.	Size, mL	Thread Style/ Closure	Bottom Style	Marking	Sterile	Pre-installed DuraSeals	Quantity	
							Rack	Case
<b>Matrix Blank and Alphanumeric Storage Tubes</b>								
4271	0.75	septa	round	blank	no	clear	96	960
4272	0.75	septa	round	blank	yes	clear	96	960
4273	0.75	septa	round	alpha	no	clear	96	960
4274	0.75	septa	round	alpha	yes	clear	96	960
4147	1.4	septa	round	alpha	no	clear	96	960
4148-11	1.4	septa	round	alpha	yes	clear	96	960
4245	1.4	septa	round	blank	no	clear	96	960
4246	1.4	septa	round	blank	yes	clear	96	960
4247	1.4	septa	round	blank	no	clear	96	960
4248	1.4	septa	round	blank	yes	clear	96	960
4251	1.4	septa	round	alpha	no	clear	96	960
4252-11	1.4	septa	round	alpha	yes	clear	96	960
<b>Matrix Blank and Alphanumeric Storage Tubes refills</b>								
4249	1.4	septa	round	blank	no	clear	96	960
4250	1.4	septa	round	blank	yes	clear	96	960
4253	1.4	septa	round	alpha	no	clear	96	960
4254	1.4	septa	round	alpha	yes	clear	96	960
<b>Matrix Blank and Alphanumeric Storage Tubes, in bulk</b>								
4170	0.75	septa	round	blank	no	clear	1000	
4140	1.4	septa	round	blank	no	clear	1000	

### Thermo Scientific Matrix Empty Racks and Lids for 2D Storage Tubes

Cat. No.	Description	Quantity/Case
4890	Latch Rack for 1.4 mL tubes	10
4893	Snap Rack for 1.4 mL tubes	10
4896	Latch Rack for 0.75 mL tubes	10
4897	Latch Rack for 1.0 mL ScrewTop tubes	5
4898	Latch Rack for 0.5 mL open top and 0.2mL ScrewTop tubes	10
4899	Latch Rack for 0.5 mL with DuraSeals	10
4900	Latch Rack for 0.5 mL ScrewTop tubes	5
4905	Rack for 12.0 mL tubes	4
4902	Latch Rack lid for 1.4 mL tubes	10
4903	Latch Rack lid for 0.75 mL tubes	10
4910	Empty Rack for 384 format tubes	20

## == Cryopreservation Manual ==

Written by researchers at the American Type Culture Collection (ATCC™), the premier biological materials resource and standards organization, the Thermo Scientific Cryopreservation Manual is an excellent, free resource for researchers who cryopreserve high value samples.

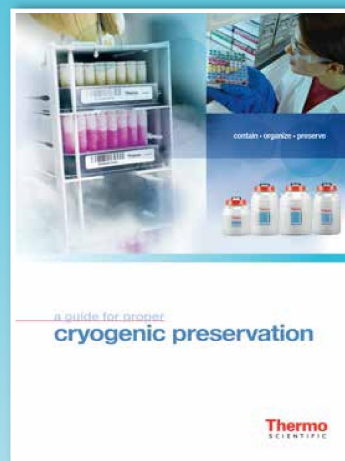

Download it for free at  
[www.thermoscientific.com/cryomanual](http://www.thermoscientific.com/cryomanual)

## Thermo Scientific™ Nunc™ ScrewTop CryoBank™ Tubes

Cat. No.	Size, mL	Thread Style/ Closure	Bottom Style	Marking	Sterile	Tube Color	Cap Color	Quantity	
								Rack	Case
374080	0.5	internal	flat	blank	yes	clear	clear	96	960
374081	1.0	internal	flat	barcode	yes	clear	clear	96	960
374258	2.0	internal	flat	barcode	yes	clear	clear	-	960
374259	2.0	internal	flat	blank	yes	clear	clear	-	960
374260	5.0	internal	flat	barcode	yes	clear	clear	-	528
374261	5.0	internal	flat	blank	yes	clear	clear	-	528
374502	1.8	external	flat	barcode	yes	clear	clear	-	480
374503	1.8	external	flat	blank	yes	clear	clear	-	480
374322	5.0	external	U	barcode	yes	clear	clear	-	240
374323	5.0	external	U	blank	yes	clear	clear	-	240
<b>Nunc CryoBank Tubes in Racks</b>									
374025	0.5	internal	flat	barcode	yes	clear	blue	96	960
374026	0.5	internal	flat	barcode	yes	clear	red	96	960
374027	0.5	internal	flat	barcode	yes	clear	green	96	960
374082	0.5	internal	flat	barcode	yes	clear	clear	96	192
374086	0.5	internal	flat	barcode	yes	clear	clear	96	960
374083	0.5	internal	flat	blank	yes	clear	clear	96	192
374087	0.5	internal	flat	blank	yes	clear	clear	96	960
374099	0.5	internal	flat	blank	yes	clear	red	96	960
374100	0.5	internal	flat	blank	yes	clear	blue	96	960
374084	1.0	internal	flat	barcode	yes	clear	clear	96	192
374088	1.0	internal	flat	barcode	yes	clear	clear	96	960
374110	1.0	internal	flat	barcode	yes	clear	green	96	960
374120	1.0	internal	flat	barcode	yes	clear	red	96	960
374130	1.0	internal	flat	barcode	yes	clear	blue	96	960
374085	1.0	internal	flat	blank	yes	clear	clear	96	192
374089	1.0	internal	flat	blank	yes	clear	clear	96	960
374094	1.0	internal	flat	alpha	yes	clear	clear	96	960
374221	2.0	internal	flat	barcode	yes	clear	clear	48	480
374223	2.0	internal	flat	blank	yes	clear	clear	48	480
374220	5.0	internal	flat	barcode	yes	clear	clear	48	480
374222	5.0	internal	flat	blank	yes	clear	clear	48	480
374500	1.8	external	flat	barcode	yes	clear	clear	48	480
374501	1.8	external	flat	blank	yes	clear	clear	48	480
374320	5.0	external	U	barcode	yes	clear	clear	24	240
374321	5.0	external	U	blank	yes	clear	clear	24	240

NEW

NEW

NEW

NEW

## Seal

### Thermo Scientific™ SepraSeal™ Caps

Cat. No.	Sterile	Cap Color	Quantity	
			Mats	Case
<b>SepraSeal Caps</b>				
4463	no	clear	96	960
4463BLU	no	blue	96	960
4463GRE	no	green	96	960
4463GRY	no	gray	96	960
4463PUR	no	purple	96	960
4463RED	no	red	96	960
4463YEL	no	yellow	96	960
4464	yes	clear	96	960
4464BLU	yes	blue	96	960
4464GRE	yes	green	96	960
4464GRY	yes	gray	96	960
4464PUR	yes	purple	96	960
4464RED	yes	red	96	960
4464YEL	yes	yellow	96	960
<b>Pre-split SepraSeal Caps</b>				
4465	no	clear	96	960
4465BLU	no	blue	96	960
4465GRE	no	green	96	960
4465GRY	no	gray	96	960
4465PUR	no	purple	96	960
4465RED	no	red	96	960
4465YEL	no	yellow	96	960
4466	yes	clear	96	960
4466BLU	yes	blue	96	960
4466GRE	yes	green	96	960
4466GRY	yes	gray	96	960
4466PUR	yes	purple	96	960
4466RED	yes	red	96	960
4466YEL	yes	yellow	96	960

### Caps for Nunc CryoBank and Matrix ScrewTop Tubes

Cat. No.	Sterile	Color	Quantity	
			Rack	Case
<b>Caps for 0.5 mL and 1.0 mL ScrewTop Tubes</b>				
4470	yes	clear	-	500
4470BLU	yes	blue	-	500
4470GRE	yes	green	-	500
4470PUR	yes	purple	-	500
4470RED	yes	red	-	500
4470WHI	yes	white	-	500
4470YEL	yes	yellow	-	500
4477	yes	clear	96	480
4477BLU	yes	blue	96	480
4477GRE	yes	green	96	480
4477PUR	yes	purple	96	480
4477RED	yes	red	96	480
4477WHI	yes	white	96	480
4477YEL	yes	yellow	96	480
374017	yes	clear	96	960
374018	yes	clear	96	960
374019	yes	gray	48	960
374021	yes	yellow	48	960
<b>Caps for Matrix 12 mL ScrewTop Tubes</b>				
4440	yes	clear	-	100
<b>Inserts for Matrix 0.5 and 1.0 mL ScrewTop Caps</b>				
4471	yes	red	-	500
4472	yes	yellow	-	500
4473	yes	blue	-	500
4474	yes	green	-	500
4475-11	yes	white	-	500
4476-11	yes	purple	-	500

### Sealing

Cat. No.	Description	Quantity/Case
4110	Thermo Scientific™ SuperSealer™	1
4423	Mat for Adhesive Seal Application	1
4469	Thermo Scientific™ SepraSeal™ Cap Removal Tool	1

### Thermo Scientific™ DuraSeal™ Caps, Bulk

Cat. No.	Sterile	Cap Color	Quantity/Case
4490	no	clear	500

### Matrix Empty Cap Trays

Cat. No.	Quantity/Case
4906	5

## Find the right tube

We provide the largest selection of biobanking tubes and accessories with choices and options for every application. Contact one of our specialists if you need expert guidance or a recommendation. Call +1 800-625-4327 or visit: [www.thermoscientific.com/samplestorage](http://www.thermoscientific.com/samplestorage).

## Track

## Thermo Scientific™ VisionTracker™ Database Software

Cat. No.	Description	Quantity/ Case
3220	VisionTracker Storage Database	1

## Thermo Scientific™ VisionMate™ Readers

Cat. No.	Description	Quantity/ Case
AB1850	VisionMate High Speed 2D Barcode Reader	1
AB1860	VisionMate High Speed Linear Barcode Reader Accessory	1
3115-11	VisionMate SR Single Rack 2D Barcode Reader	1
3125	VisionMate ST Single Tube 2D Barcode Reader	1

## Store

## Thermo Scientific™ Universal™ Latch Racks

Cat. No.	Size, mL	Compatibility	Sterile	Quantity	
				Rack	Case
331825	2.0	Latch Rack CryoBank	no	-	10
331826	5.0	Latch Rack CryoBank	no	-	10
331827	1.0 - 2.0	Latch Rack Standard Cryotube	no	-	10
331828	3.6 - 5.0	Latch Rack Standard Cryotube	no	-	10
337830	1.8	Latch Rack Externally Threaded Universal	no	-	10
331840	5.0	Latch Rack Externally Threaded Low Profile	no	-	10

NEW

## Process

## Thermo Scientific 8-Channel Screw Cap Capper/Decapper

Cat. No.	Description	Compatible Tubes	Quantity/ Case
4105MAT	8-Channel Handheld Screw Cap Capper/Decapper with Stand for Matrix™-style Tubes	Matrix ScrewTop 0.5 and 1.0mL Tubes	1
4105NUN	8-Channel Handheld Screw Cap Capper/Decapper with Stand for Nunc, Cryobank and Universal-style Tubes	Nunc CryoBank 0.5, 1.0, 2.0 and 5.0 mL, Matrix Universal 0.2mL Tubes	1
4106	Capper/Decapper Stand	-	1
4109	Capper/Decapper spare power supply	-	1

## Thermo Scientific™ Capit-All™ and Capit-All IS™ Screw Cap Tube Capper/Decapper

Cat. No.	Description	Compatibility	Channels	Quantity/ Case
4111MAT	Capit-All ScrewTop Tube Capper/Decapper for 96 format Matrix Tubes	Universal 0.2ml ScrewTop Tubes; Matrix ScrewTop 0.5 and 1.0 mL Tubes	96	1
4111MAT-IS	Automation Friendly Capit- All ScrewTop Tube Capper/Decapper for 96 format Matrix Tubes	Universal 0.2ml ScrewTop Tubes; Matrix ScrewTop 0.5 and 1.0 mL Tubes	96	1
4111NUN	Capit-All ScrewTop Tube Capper/Decapper for 96 format Nunc Tubes	Nunc CryoBank 0.5 and 1.0 mL Tubes	96	1
4111NUN-IS	Automation Friendly Capit-All ScrewTop Tube Capper/Decapper for 96 format Nunc Tubes	Nunc CryoBank 0.5 and 1.0 mL Tubes	96	1
4114NUN	Capit-All ScrewTop Tube Capper/Decapper for 48 format Nunc ScrewTop Tubes	1.8ml Universal Externally threaded tubes; Nunc CryoBank 2.0 and 5.0 mL Tubes	48	1
4114NUN-IS	Automation Friendly Capit-All ScrewTop Tube Capper/ Decapper for 48 format Nunc ScrewTop Tubes	1.8ml Universal Externally threaded tubes; Nunc CryoBank 2.0 and 5.0 mL Tubes	48	1
4112NUN	Capit-All ScrewTop Tube Capper/Decapper for 24 format Nunc ScrewTop Tubes	Nunc Internally Threaded Cryotubes	24	1
4113NUN	Capit-All ScrewTop Tube Capper/Decapper for 24 format Nunc ScrewTop Tubes	Nunc Externally Threaded Cryotubes	24	1
4113NAL	Capit-All ScrewTop Tube Capper/Decapper for 24 format Nalgene™ ScrewTop Tubes	Nalgene Externally Threaded Cryotubes	24	1

## Capit-All Screw Cap Tube Capper/Decapper Accessories

Cat. No.	Description	Compatibility	Quantity/ Case
4090	ScrewTop Cap Tray Lifter for Capit-All (4111MAT)	0,5 mL Matrix tubes	1
4091	ScrewTop Cap Tray Lifter for Capit-All (4111MAT)	1,0 mL Matrix tubes	1
N12030	ScrewTop Cap Tray Lifter for Capit-All (4111NUN)	0,5 mL Nunc tubes	1
N12031	ScrewTop Cap Tray Lifter for Capit-All (4111NUN)	1,0 mL Nunc tubes	1

# Full Product List

## Process

### Thermo Scientific™ SampleSeal™ Tube Sealer

Cat. No.	Description	Compatibility	Quantity/ Case	
4220-096	SampleSeal 96- Format Heat Sealer	Select Matrix 96-Format tubes	1	NEW
4220-384	SampleSeal 384- Format Heat Sealer	Matrix 384 format tubes	1	NEW
4221-025	SampleSeal 25µm Pierceable foil	384-Format SampleSeal	1	NEW
4221-040	SampleSeal 40µm Pierceable foil	96-Format SampleSeal	1	NEW

### Thermo Scientific™ SampleArray™ Tube Handler

Cat. No.	Description	Compatibility	Quantity/ Case	
5220-4896	SampleArray Base Unit	48- and 96-Format Thermo Scientific Tubes	1	NEW
5220-4896WM	SampleArray Base Unit with pre-installed Weight Module	48- and 96-Format Thermo Scientific Tubes	1	NEW
5220-384	SampleArray Base Unit	384-format Thermo Scientific Tubes	1	NEW
5220-384WM	SampleArray Base Unit with pre-installed Weight Module	384-format Thermo Scientific Tubes	1	NEW
5221-WM4896	SampleArray Base Weigh Station Accessory	48- and 96-format Thermo Scientific Tubes	1	NEW
5221-WM384	SampleArray Base Weigh Station Accessory	384-format Thermo Scientific Tubes	1	NEW

Visit [www.thermoscientific.com/samplestorage](http://www.thermoscientific.com/samplestorage)

[thermoscientific.com](http://thermoscientific.com)

© 2014 Thermo Fisher Scientific Inc. All rights reserved. Excel is a trademark of Microsoft Corporation. ATCC is a trademark of American Type Culture Collection. Bluetooth is a trademark of Bluetooth Sig, Inc. All other trademarks are the property of Thermo Fisher Scientific Inc. and its subsidiaries. Specifications, terms and pricing are subject to change. Not all products are available in all countries. Please consult your local sales representative for details.

**ANZ:** Australia: 1300 735 292, New Zealand: 0800 933 966; **Asia:** China Toll-free: 800-810-5118 or 400-650-5118; India: +91 22 6716 2200, India Toll-free: 1 800 22 8374; Japan: +81-3-5826-1616; Other Asian countries: 65 68729717  
**Europe:** Austria: +43 1 801 40 0; Belgium: +32 2 482 30 30; Denmark: +45 4631 2000; France: +33 2 2803 2180; Germany: +49 6184 90 6000, Germany Toll-free: 0800 1-536 376; Italy: +39 02 95059 554; Netherlands: +31 76 571 4440; Nordic/Baltic countries: +358 9 329 10200; Russia/CIS: +7 (812) 703 42 15; Spain/Portugal: +34 93 223 09 18; Switzerland: +41 44 454 12 22; UK/Ireland: +44 870 609 9203  
**North America:** USA/Canada +1 585 586 8800; USA Toll-free: 800 625 4327  
**South America:** USA sales support: +1 585 899 7198 **Countries not listed:** +49 6184 90 6000 or +33 2 2803 2000

BRLSPCRYOAUTO 0414

**Thermo**  
SCIENTIFIC

Part of Thermo Fisher Scientific