

Airstream®

**Airstream® Gen 3 Laminar Flow Cabinet,
Model LHG-4AG-F**

**Airstream® Gen 3 Vertical Laminar Cabinet,
Model LVG-4AG-S (with Sliding Sash)**

Laminar Flow Cabinets, Horizontal and Vertical

The Leading Solution for Research Laboratories

More product variants and sizes to suit more applications and user preferences

KEY BENEFITS:

- *Energy-efficient DC ECM blower*
- *ULPA filter (ISO Class 3 work-zone)*
- *Sentinel™ Gold microprocessor control system*
- *Isocide™ antimicrobial powder coating*
- *Standby mode for more energy savings*
- *Stable and self-compensating airflow*
- *Real-time airflow monitoring*
- *With fixed sash and sliding sash option (for vertical models)*

ESCO
SCIENTIFIC

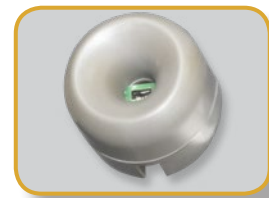

Sentinel™ Gold Microprocessor Controller

- Displays all safety information on one screen
- Standby mode switch for more energy savings
- Programmable UV timer to extend the UV lamp lifespan



Ergonomic Control Panel Location

- Centered and angled down for an easy reach & viewing
- ADA-compliant



Work Top

- Spill-retaining work top designed with a recessed central area to contain accidental liquid spills.

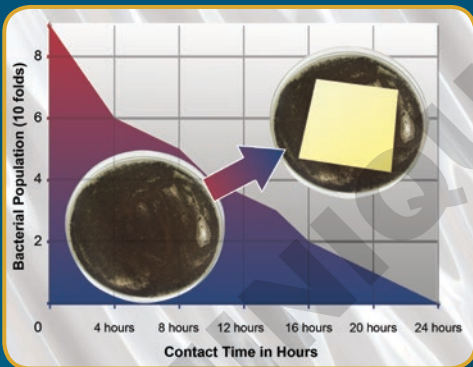

Isocide™ Antimicrobial Coating

- Silver-ion impregnated powder coat
- Inhibits the microbial growth to improve safety



Guide to Models

1st Placeholder Product Line	2nd Placeholder Flow	3rd Placeholder Side Wall	4th Placeholder Width	5th Placeholder Internal Height	6th Placeholder Control	7th Placeholder Window	8th Placeholder Electrical
Laminar Flow	L	Tempered Glass	3 feet	2 feet	Sentinel™ Gold	Fixed	230 VAC, 50 / 60 Hz
	H	Stainless Steel	4 feet	2.5 feet			115 VAC, 50 / 60 Hz
			5 feet	3 feet			
			6 feet				
			8 feet				

Example Code: LHG-4BG-F8

Specifications: Laminar flow cabinet, horizontal, tempered glass side wall, 4 ft width, 2.5 ft internal height, Sentinel™ Gold microprocessor controller, Fixed window and 230 VAC, 50/60 Hz

Airflow Sensor

- Real-time airflow monitoring system
- Alerts the user if the airflow is insufficient

Energy-efficient DC ECM Blower

- Powered by the latest generation DC ECM that is more efficient than legacy ECM and VFD motors
- 70% energy savings compared to AC motor
- Stable airflow despite building voltage fluctuations & filter loading
- Standby mode that provides ISO Class 5 work-zone



Airstream® Horizontal Laminar Flow Cabinet, LHG-4AG-F_

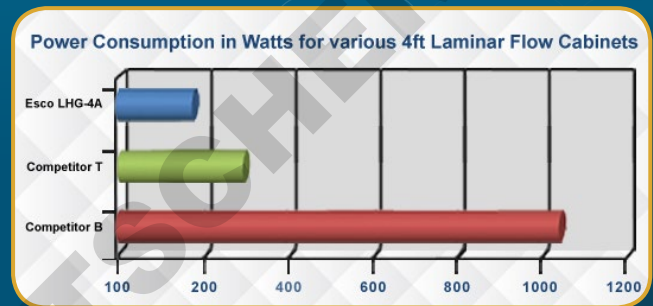
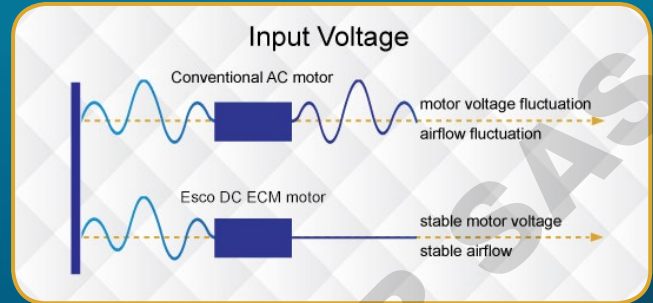
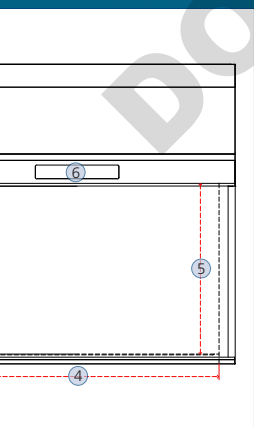

ULPA Filter

- 10x filtration efficiency than of HEPA filter, creates an ISO Class 3 work-zone instead of the industry-standard ISO Class 5
- 10x cleaner work-zone than cabinets with HEPA filter

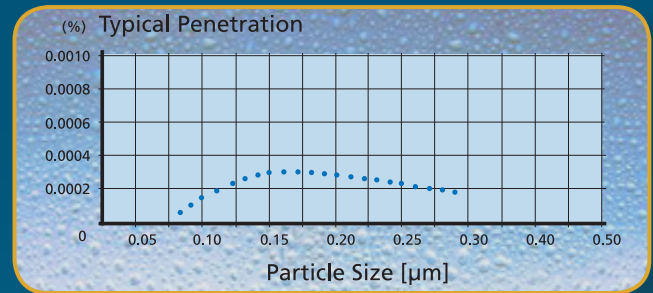

Quiet Operation

- Comfortable low noise at 55 dBA
**LHG-4B in an open field condition*
- Reduces fatigue and improves work concentration



Standards Compliance	Cabinet Performance	Air Quality	Filtration	Electrical Safety
	IEST-RP-CC002.2, Worldwide	ISO 14644.1, Class 3, Worldwide AS 1386 Class 1.5, Australia JIS B9920, Class 3, Japan	EN-1822 (H14), Europe IEST-RP-CC001.3, Worldwide IEST-RP-CC007, Worldwide IEST-RP-CC034.1, Worldwide	IEC61010-1, Worldwide EN 61010-1, Europe UL61010-1, USA CAN/CSA-22.2, No.61010-1



Rocker Switches

- Easy-to-use switches
- Displays filter loading status
- Manually adjustable UV timer

Note: Rocker switch models are available in USA only



Sentinel™ Gold Microprocessor Controller

- Displays all safety information on one screen
- Standby mode switch for more energy savings
- Programmable UV timer to extend the UV lamp lifespan



Ergonomic Control Panel Location

- Centered and angled down for an easy reach & viewing
- ADA-compliant



Work Top

- Spill-retaining work top designed with a recessed central area to contain accidental liquid spills.

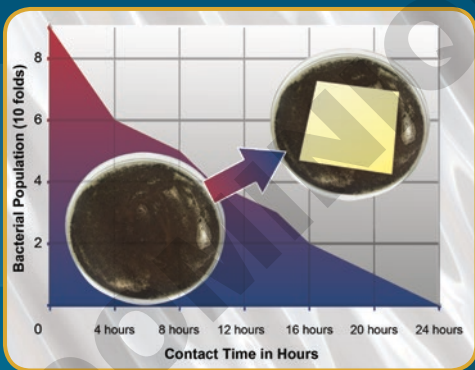

Isocide™ Antimicrobial Coating

- Silver-ion impregnated powder coat
- Inhibits the microbial growth to improve safety



Airstream® Vertical Laminar Flow Cabinet, LVG-4AG-S

Guide to Models

1st Placeholder Product Line	2nd Placeholder Flow	3rd Placeholder Side Wall	4th Placeholder Width	5th Placeholder Internal Height	6th Placeholder Control	7th Placeholder Window	8th Placeholder Electrical
Laminar Flow	L	Tempered Glass	3 feet	2.25 feet	Sentinel™ Gold	Fixed Sash	230 VAC, 50 / 60 Hz
	V	Stainless Steel	4 feet	3 feet	Rocker Switches	Sliding Sash	115 VAC, 50 / 60 Hz
			5 feet				
			6 feet				
			8 feet				

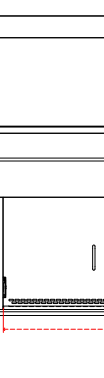

Airflow Sensor

- Real-time airflow monitoring system
- Alerts the user if the airflow is insufficient

Energy-efficient DC ECM Blower

- Powered by the latest generation DC ECM that is more efficient than legacy ECM and VFD motors
- 70% energy savings compared to AC motor
- Stable airflow despite building voltage fluctuations & filter loading
- Standby mode that provides ISO Class 5 work-zone

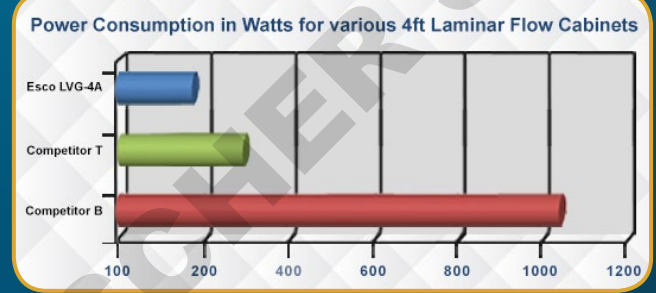
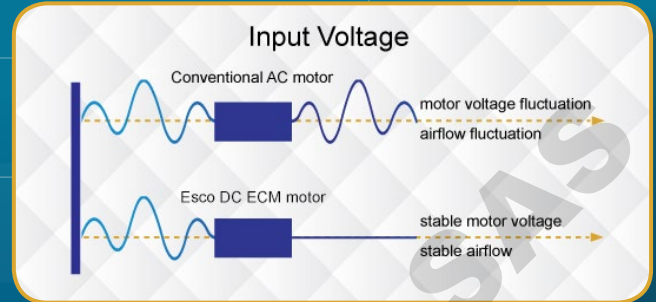

ULPA Filter

- 10x filtration efficiency than of HEPA filter, creates ISO Class 3 work-zone instead of industry-standard ISO Class 5
- 10x cleaner work-zone than cabinets with HEPA filter

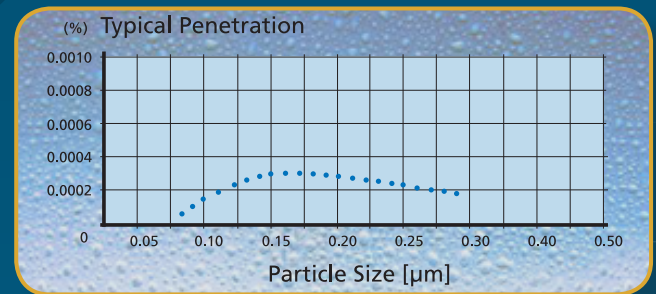

Sash Window Options

- Polycarbonate fixed sash
- Manual sliding sash made of UV-resistant tempered glass

Quiet Operation

- Comfortable low noise emission at 52 dBA
**LVG-4AG-F_ in an open field condition*
- Reduces fatigue and improves work concentration

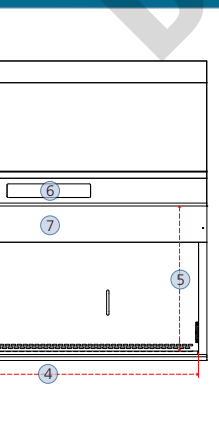

	Cabinet Performance	Air Quality	Filtration	Electrical Safety
Standards Compliance	IEST-RP-CC002.2, Worldwide	ISO 14644.1, Class 3, Worldwide AS 1386 Class 1.5, Australia JIS B9920, Class 3, Japan	EN-1822 (H14), Europe IEST-RP-CC001.3, Worldwide IEST-RP-CC007, Worldwide IEST-RP-CC034.1, Worldwide	IEC61010-1, Worldwide EN 61010-1, Europe UL61010-1, USA CAN/CSA-22.2, No.61010-1

Airstream® Horizontal Laminar Flow Stainless Steel Side Wall Version



Cabinet Filtration System

- Room air drawn in from the top of the cabinet through a disposable pre-filter with 85% arrestance, trapping larger particles and prolonging the life of the main filter.
- Air is forced evenly across the ULPA/H14 filter. The result is a stream of clean laminar air with the work-zone, diluting and flushing contaminants present in the interior. The purified air travels in a horizontal, unidirectional stream towards the open front of the cabinet.
- A nominal filter face velocity of 0.45 m/s or 90 fpm ensures that there is a sufficient number of air changes within the enclosed area of the cabinet to maintain the cleanliness.

Airflow Diagram

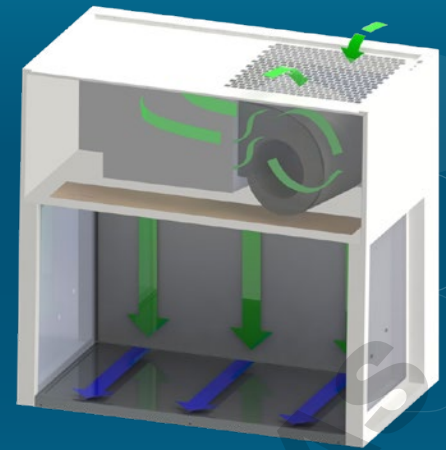

- ULPA-filtered air
- Room air / Inflow air

Airstream® Horizontal Laminar Flow Engineering Drawing

6

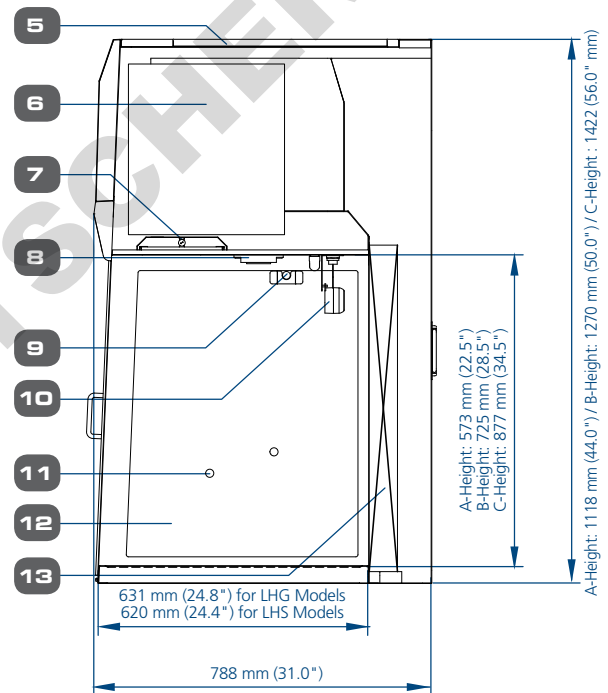
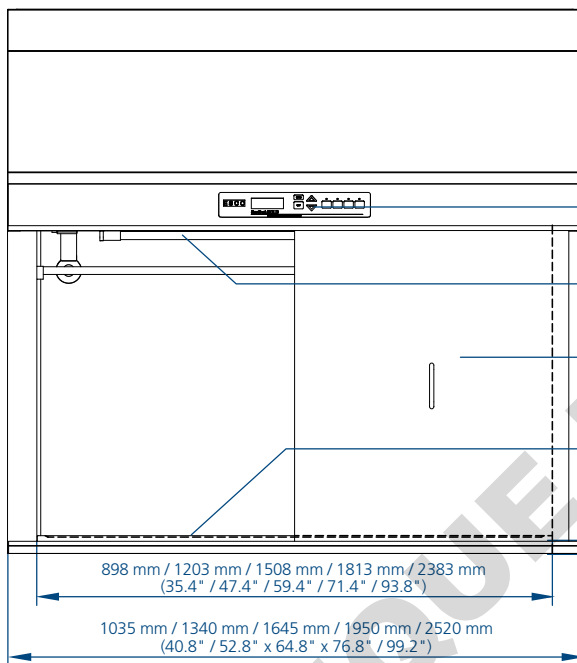

- Esco Sentinel™ Gold Microprocessor Controller
- UV Light Retrofit Kit Provision
- (Optional) Front Cover
- Spill-retaining Stainless Steel Work Top
- Pre-filter
- DC ECM Blower
- Fluorescent Lamp
- Electrical Outlet Provision (maximum of 2)
- IV Bar Retrofit Kit Provision
- Air Flow Sensor
- Service Fixture Retrofit Kit Provision (2 on each side)
- Tempered Glass Side Walls (for LHG Variant)
Stainless Steel Side Walls (for LHS Variant)
- ULPA / H14 Filter

Esco Horizontal and Vertical Laminar Flow Cabinets Accessories

Model	3 feet Width	4 feet Width	5 feet Width	6 feet Width	8 feet Width
UV Lamp	UV-15A-L 5170251		UV-30A-L 5170255		UV-30A-L *2
Electrical Outlet	EO-				
IV Bar Horizontal Flow	IV-890 5170608	IV-1195 5170609	IV-1500 5170610	IV-1805 5170611	IV-2375 5170662
IV Bar Vertical Flow	IV-960 5170603	IV-1265 5170604	IV-1570 5170605	IV-1875 5170606	IV-2445 5170607
PVC Arm Rest	ME-W-REST 5170127				
Height-adjustable Lab Chair (Blue)	ME-LD-AR360 1150006				
Ergonomic Foot Rest	FT-REST 5170073				
Support Stand Telescoping with Castors (28" to 34")	STC-3A0 5130055	STC-4A0 5130056	STC-5A0 5130057	STC-6A0 5130058	STC-8A0 Gen2 5131146
Support Stand Telescoping with Leveling Feet (28" to 34")	STL-3A0 5130050	STL-4A0 5130051	STL-5A0 5130052	STL-6A0 5130053	STL-8A0 Gen2 5131150
Support Stand with Leveling Feet (28")	SAL-3A0 Gen2 5130170	SAL-4A0 Gen2 5130134	SAL-5A0 Gen2 5130171	SAL-6A0 Gen2 5130172	SAL-8A0 Gen2 5131124
Support Stand with Leveling Feet (34")	SAL-3B0 Gen2 5130174	SAL-4B0 Gen2 5130175	SAL-5B0 Gen2 5130176	SAL-6B0 Gen2 5130177	SAL-8B0 Gen2 5131125
Pre-filter	Horizontal	PF-4 5090003	PF-2 (2 pcs) 5090001	PF-3 and PF-4 5090002 and 5090003	PF-2 (3 pcs) 5090001 PF-4 (2 pcs) 5090003
	Vertical				PF-2 and PF-4 (2 pcs) 5090001 and 5090003

Airstream® Vertical Laminar Flow Stainless Steel Side Wall Version



Cabinet Filtration System

- Room air drawn in from the top of the cabinet through a disposable pre-filter with 85% arrestance, trapping larger particles and prolonging the life of the main filter.
- Air is forced evenly across the ULPA/H14 filter. The result is a stream of clean laminar air with the work-zone, diluting and flushing contaminants present in the interior. The purified air travels in a vertical, unidirectional stream towards the open front and back of the cabinet.
- A nominal filter face velocity of 0.45 m/s or 90 fpm ensures that there is a sufficient number of air changes within the enclosed area of the cabinet to maintain the cleanliness.

Airflow Diagram

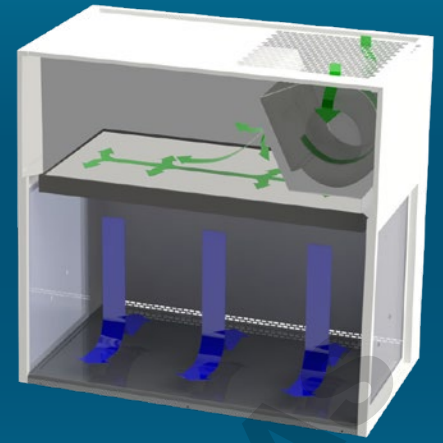

■ ULPA-filtered air
■ Room air / Inflow air

Airstream® Vertical Laminar Flow Engineering Drawing

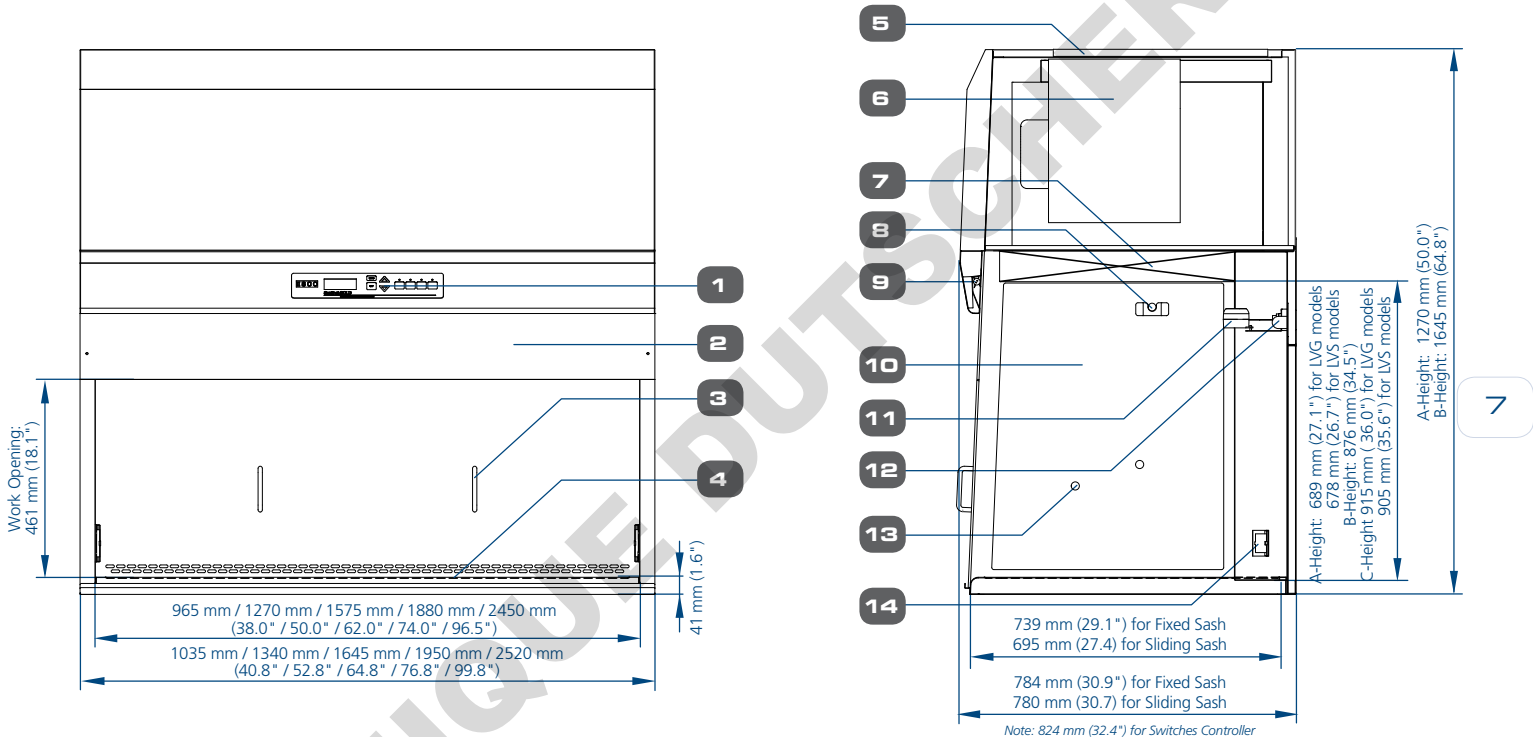

- Esco Sentinel™ Gold Microprocessor Control System / Simple Switches Control System
- Fixed Sash (LV_-F variant)
(Optional) Manual Sliding Sash (LV_-S variant)
- Optional Front Cover
- Stainless Steel Work Top
- Pre-filter
- DC ECM Blower (Self-compensating and lower noise)
- ULPA filter
- UV Bar Retrofit Kit Provision
- Fluorescent Lamp
- Tempered Glass Side Walls (for LVG Variant)
Stainless Steel Side Walls (for LVS Variant)
- Airflow Sensor
- UV Lamp
- Service Fixture Retrofit Kit Provision (2 holes on each side)
- Electrical Outlet Retrofit Kit provision (1 outlet on each side)

Esco Horizontal and Vertical Laminar Flow Cabinets Front Cover

	3 feet	4 feet	5 feet	6 feet	8 feet
LHG / LHS	FC-LHG / LHS-3A 5170601	FC-LHG / LHS-4A 5170602	FC-LHG / LHS-5A 5170585	FC-LHG / LHS-6A 5170586	
	FC-LHG / LHS-3B 5170587	FC-LHG / LHS-4B 5170588	FC-LHG / LHS-5B 5170589	FC-LHG / LHS-6B 5170590	
	FC-LHG / LHS-3C 5170627	FC-LHG / LHS-4C 5170591		FC-LHG / LHS-6C 5170592	FC-LHG / LHS-8C 5170593
LVG / LVS	FC-LVG / LVS-3A 5170595	FC-LVG / LVS-4A 5170584	FC-LVG / LVS-5A 5170596	FC-LVG / LVS-6A 5170597	
		FC-LVG / LVS-4C 5170598	FC-LVG / LVS-5C 5170061	FC-LVG / LVS-6C 5170599	FC-LVG / LVS-8C 5170600

**General Specifications, Airstream® Vertical Laminar Flow Cabinets, A-Height (Interior Height: 2.25 ft / 0.7 m)
with Sentinel™ Gold Microprocessor Control System**

		LVS-3AG-F8 2120381	LVS-4AG-F8 2120382	LVS-5AG-F8 2120383	LVS-6AG-F8 2120384
Stainless Steel Sides			LVS-4AG-S8 2120759	LVS-5AG-S8 2120766	LVS-6AG-S8 2120760
		LVS-3AG-F9 2120443	LVS-4AG-F9 2120445	LVS-5AG-F9 2120447	LVS-6AG-F9 2120449
			LVS-4AG-S9 2120762	LVS-5AG-S9 2120767	LVS-6AG-S9 2120764
		LVG-3AG-F8 2120374	LVG-4AG-F8 2120369	LVG-5AG-F8 2120375	LVG-6AG-F8 2120407
Glass Sides			LVG-4AG-S8 2120701	LVG-5AG-S8 2120755	LVG-6AG-S8 2120703
		LVG-3AG-F9 2120435	LVG-4AG-F9 2120437	LVG-5AG-F9 2120439	LVG-6AG-F9 2120441
			LVG-4AG-S9 2120761	LVG-5AG-S9 2120768	LVG-6AG-S9 2120763
Nominal Size		0.9 meter (3')	1.2 meter (4')	1.5 meter (5')	1.8 meter (6')
External Dimensions without Base Stand (W x D x H)	Fixed Sash Models	1035 x 784 x 1270 mm (40.8" x 30.9" x 50.0")	1340 x 784 x 1270 mm (52.8" x 30.9" x 50.0")	1645 x 784 x 1270 mm (64.8" x 30.9" x 50.0")	1950 x 784 x 1270 mm (76.8" x 30.9" x 50.0")
	Sliding Sash Models		1340 x 780 x 1270 mm (52.8" x 30.7" x 50.0")	1645 x 780 x 1270 mm (64.8" x 30.7" x 50.0)	1950 x 780 x 1270 mm (76.8" x 30.7" x 50.0")
Internal Work Area, Dimensions (W x D x H)	LVG Models (Fixed Sash)	965 x 739 x 689 mm (38.0" x 29.1" x 27.1")	1270 x 739 x 689 mm (50.0" x 29.1" x 27.1")	1575 x 739 x 689 mm (62.0" x 29.1" x 27.1")	1880 x 739 x 689 mm (74.0" x 29.1" x 27.1")
	LVG Models (Sliding Sash)		1270 x 695 x 689 mm (50.0" x 27" x 27.1")	1575 x 695 x 689 mm (62.0" x 27.3" x 27.1")	1880 x 695 x 689 mm (74.0" x 27" x 27.1")
	LVS Models (Fixed Sash)	965 x 739 x 678 mm (38.0" x 29.1" x 26.7")	1270 x 739 x 678 mm (50.0" x 29.1" x 26.7")	1575 x 739 x 678 mm (62.0" x 29.1" x 26.7")	1880 x 739 x 678 mm (74.0" x 29.1" x 26.7")
	LVS Models (Sliding Sash)		1270 x 695 x 678 mm (50.0" x 27" x 26.7")	1575 x 695 x 678 mm (62.0" x 27.3" x 26.7")	1880 x 695 x 678 mm (74.0" x 27" x 26.7")
Internal Work Area, Space		0.6 m ² (6.5 ft ²)	0.8 m ² (8.6 ft ²)	1.0 m ² (10.7 ft ²)	1.3 m ² (14.0 ft ²)
Average Airflow Velocity		0.45 m/s (90 fpm) at initial setpoint			
Air Volume		1117 m ³ /hr (657 cfm)	1471 m ³ /hr (866 cfm)	1824 m ³ /hr (1074 cfm)	2177 m ³ /hr (1281 cfm)
ULPA Filter Typical Efficiency		> 99.999% at particle size between 0.1 to 0.2 µm			
Sound Emission per IEST-RP-CC002.2*		51.6 dBA	52.4 dBA	55.6 dBA	57.6 dBA
Fluorescent Lamp Intensity at Zero Ambient		980 Lux (94 foot candles)	904 Lux (84 foot candles)	894 Lux (83 foot candles)	1062 Lux (99 foot candles)
Cabinet Construction	Main Body	1.2 mm (0.05") 18-gauge electro-galvanized steel with white oven-baked epoxy-polyester powder-coated finish			
	Work Zone	1.2 mm (0.05") 18-gauge stainless steel, grade 304, with 4B finish			
	Side Walls	LVS Models: 1.2 mm (0.05") 18 gauge stainless steel, grade 304, with 4B finish			
		LVG Models: UV Resistant tempered glass, 5 mm (0.2"), colorless and transparent			
Sash Window	Fixed Sash: 5 mm (0.2") UV Resistant Polycarbonate Sash with 461 mm (18.1") opening				
	Manual Sliding Sash: 5 mm (0.2") UV Resistant Tempered Glass with counter-balance system and ergonomic handle				
Electrical Power Rating 8: 220-240 VAC, 50 / 60 Hz, 1 phase	Cabinet Full Load Amps (FLA)	7.3 A	7.5 A	7.8 A	8.5 A
	Optional Outlets (FLA)	5 A			
	Cabinet Nominal Power (W)	129	151	199	258
	Heat Rejected, BTU per Hour	440	515	679	880
Electrical Power Rating 9: 110-130 VAC, 50 / 60 Hz, 1 phase	Cabinet Full Load Amps (FLA)	12 A	12.5 A	13.3 A	13.5 A
	Optional Outlets (FLA)	5 A			
	Cabinet Nominal Power (W)	132	155	204	264
	Heat Rejected, BTU per Hour	450	529	696	908
Net Weight**		135 Kg (298 lbs)	158 Kg (348 lbs)	199 Kg (438 lbs)	208 Kg (459 lbs)
Shipping Weight**		167 Kg (368 lbs)	202 Kg (445 lbs)	256 Kg (564 lbs)	273 Kg (602 lbs)
Shipping Dimensions, Maximum (W x D x H)**		1120 x 900 x 1590 mm (44" x 35" x 62")	1400 x 900 x 1590 mm (55" x 35" x 62")	1720 x 900 x 1590 mm (68" x 35" x 62")	2200 x 900 x 1590 mm (87" x 35" x 62")
Shipping Volume, Maximum**		1.6 m ³ (56.6 ft ³)	2.0 m ³ (70.6 ft ³)	2.5 m ³ (88.2 ft ³)	3.3 m ³ (116.5 ft ³)

Specifications are subject to change without notice.

*Noise reading in open field condition / anechoic chamber. Noise reading in normal room varies by room size, layout, and background noise, but may reach roughly 3 dBA above these values.

**Cabinet only, excludes optional stand.

General Specifications, Airstream® Horizontal Laminar Flow Cabinets, A-Height (Interior Height: 2 ft / 0.6 m)

		LHS-3AG-F8 2120377	LHS-4AG-F8 2120378	LHS-5AG-F8 2120379	LHS-6AG-F8 2120380
Stainless Steel Sides		LHS-3AG-F9 2120425	LHS-4AG-F9 2120427	LHS-5AG-F9 2120429	LHS-6AG-F9 2120431
	Glass Sides	LHG-3AG-F8 2120387	LHG-4AG-F8 2120368	LHG-5AG-F8 2120372	LHG-6AG-F8 2120373
		LHG-3AG-F9 2120417	LHG-4AG-F9 2120419	LHG-5AG-F9 2120421	LHG-6AG-F9 2120423
Nominal Size		0.9 meter (3')	1.2 meter (4')	1.5 meter (5')	1.8 meter (6')
External Dimensions (W x D x H)	Without Base Stand	1035 x 795 x 1118 mm (40.8" x 31.3" x 44.0")	1340 x 795 x 1118 mm (52.8" x 31.3" x 44.0")	1645 x 795 x 1118 mm (64.8" x 31.3" x 44.0")	1955 x 795 x 1118 mm (76.8" x 31.3" x 44.0")
	Internal Work Area, Dimensions (W x D x H)	LHG Models	898 x 631 x 573 mm (35.4" x 24.8" x 22.5")	1203 x 631 x 573 mm (47.4" x 24.8" x 22.5")	1508 x 631 x 573 mm (59.4" x 24.8" x 22.5")
LHS Models		898 x 620 x 573 mm (35.4" x 24.4" x 22.5")	1203 x 620 x 573 mm (47.4" x 24.4" x 22.5")	1508 x 620 x 573 mm (59.4" x 24.4" x 22.5")	1813 x 620 x 573 mm (71.4" x 24.4" x 22.5")
Internal Work Area, Space		0.5 m ² (5.4 ft ²)	0.7 m ² (7.5 ft ²)	0.9 m ² (9.6 ft ²)	1.0 m ² (10.8 ft ²)
Average Airflow Velocity		0.45 m/s (90 fpm) at initial setpoint			
Air Volume		834 m ³ /hr (491 cfm)	1117 m ³ /hr (657 cfm)	1400 m ³ /hr (824 cfm)	1683 m ³ /hr (911 cfm)
ULPA Filter Typical Efficiency		> 99.999% at particle size between 0.1 to 0.2 µm			
Sound Emission per IEST-RP-CC002.2*		53.2 dBA	55.8 dBA	58.4 dBA	60.0 dBA
Fluorescent Lamp Intensity at Zero Ambient		1045 Lux (97 foot candles)	1139 Lux (106 foot candles)	984 Lux (91 foot candles)	1221 Lux (113 foot candles)
Cabinet Construction	Main Body	1.2 mm (0.05") 18-gauge electro-galvanized steel with white oven-baked epoxy-polyester powder-coated finish			
	Work Zone	1.2 mm (0.05") 18-gauge stainless steel, grade 304, with 4B finish			
	Side Walls	LHS Models: 1.2 mm (0.05") 18 gauge stainless steel, grade 304, with 4B finish LHG Models: UV absorbing tempered glass, 5 mm (0.2"), colorless and transparent			
Electrical Power Rating 8: 220-240 VAC, 50 / 60 Hz, 1 phase	Cabinet Full Load Amps (FLA)	7 A	7.3 A	7.6 A	8 A
	Optional Outlets (FLA)	5 A			
	Cabinet Nominal Power (W)	140	171	211	249
	Heat Rejected, BTU per Hour	478	583	720	850
Electrical Power Rating 9: 110-130 VAC, 50 / 60 Hz, 1 phase	Cabinet Full Load Amps (FLA)	11.3 A	11.4 A	11.4 A	11.5 A
	Optional Outlets (FLA)	5 A			
	Cabinet Nominal Power (W)	144	175	216	255
	Heat Rejected, BTU per Hour	491	597	737	870
Net Weight**		100 Kg (220 lbs)	145 Kg (320 lbs)	167 Kg (368 lbs)	212 Kg (467 lbs)
Shipping Weight**		132 Kg (291 lbs)	200 Kg (440 lbs)	224 Kg (494 lbs)	277 Kg (611 lbs)
Shipping Dimensions, Maximum (W x D x H)**		1120 x 900 x 1590 mm (44" x 35" x 62")	1400 x 900 x 1590 mm (55" x 35" x 62")	1720 x 900 x 1590 mm (68" x 35" x 62")	2200 x 900 x 1590 mm (87" x 35" x 62")
Shipping Volume, Maximum**		1.6 m ³ (56.6 ft ³)	2.0 m ³ (70.6 ft ³)	2.5 m ³ (88.2 ft ³)	3.3 m ³ (116.5 ft ³)

Specifications are subject to change without notice.

*Noise reading in open field condition / anechoic chamber. Noise reading in normal room varies by room size, layout, and background noise, but may reach roughly 3 dBA above these values.

**Cabinet only, excludes optional stand.

General Specifications, Airstream® Horizontal Laminar Flow Cabinets, B-Height (Interior Height: 2.5 ft / 0.8 m)

		LHS-3BG-F8 2120463	LHS-4BG-F8 2120465	LHS-5BG-F8 2120467	LHS-6BG-F8 2120469
Stainless Steel Sides		LHS-3BG-F8 2120463	LHS-4BG-F8 2120465	LHS-5BG-F8 2120467	LHS-6BG-F8 2120469
		LHS-3BG-F9 2120503	LHS-4BG-F9 2120505	LHS-5BG-F9 2120507	LHS-6BG-F9 2120509
Glass Sides		LHG-3BG-F8 2120453	LHG-4BG-F8 2120455	LHG-5BG-F8 2120457	LHG-6BG-F8 2120459
		LHG-3BG-F9 2120493	LHG-4BG-F9 2120495	LHG-5BG-F9 2120497	LHG-6BG-F9 2120499
Nominal Size		0.9 meter (3')	1.2 meter (4')	1.5 meter (5')	1.8 meter (6')
External Dimensions (W x D x H)	Without Base Stand	1035 x 788 x 1270 mm (40.8" x 31.0" x 50.0")	1340 x 788 x 1270 mm (52.8" x 31.0" x 50.0")	1645 x 788 x 1270 mm (64.8" x 31.0" x 50.0")	1950 x 788 x 1270 mm (76.8" x 31.0" x 50.0")
	Internal Work Area, Dimensions (W x D x H)	LHG Models	898 x 631 x 725 mm (35.4" x 24.8" x 28.5")	1203 x 631 x 725 mm (47.4" x 24.8" x 28.5")	1508 x 631 x 725 mm (59.4" x 24.8" x 28.5")
LHS Models		898 x 620 x 725 mm (35.4" x 24.4" x 28.5")	1203 x 620 x 725 mm (47.4" x 24.4" x 28.5")	1508 x 620 x 725 mm (59.4" x 24.4" x 28.5")	1813 x 620 x 725 mm (71.4" x 24.4" x 28.5")
Internal Work Area, Space		0.5 m ² (5.4 ft ²)	0.7 m ² (7.5 ft ²)	0.9 m ² (9.6 ft ²)	1.0 m ² (10.8 ft ²)
Average Airflow Velocity	0.45 m/s (90 fpm) at initial setpoint				
Air Volume		1055 m ³ /hr (621 cfm)	1413 m ³ /hr (832 cfm)	1771 m ³ /hr (1042 cfm)	2129 m ³ /hr (1253 cfm)
ULPA Filter Typical Efficiency	> 99.999% at particle size between 0.1 to 0.2 µm				
Sound Emission per IEST-RP-CC002.2*		52.8 dBA	55.4 dBA	58.0 dBA	59.6 dBA
Fluorescent Lamp Intensity at Zero Ambient		1279 Lux (119 foot candles)	1394 Lux (130 foot candles)	1204 Lux (112 foot candles)	1494 Lux (139 foot candles)
Cabinet Construction	Main Body	1.2 mm (0.05") 18-gauge electro-galvanized steel with white oven-baked epoxy-polyester powder-coated finish			
	Work Zone	1.2 mm (0.05") 18-gauge stainless steel, grade 304, with 4B finish			
	Side Walls	LHS Models: 1.2 mm (0.05") 18 gauge stainless steel, grade 304, with 4B finish LHG Models: UV absorbing tempered glass, 5 mm (0.2"), colorless and transparent			
Electrical Power Rating 8: 220-240 VAC, 50 / 60 Hz, 1 phase	Cabinet Full Load Amps (FLA)	7 A	7.3 A	7.6 A	8 A and 3 A (2 Power Inlet)
	Optional Outlets (FLA)	5 A			
	Cabinet Nominal Power (W)	160	207	255	302
	Heat Rejected, BTU per Hour	546	702	870	1030
Electrical Power Rating 9: 110-130 VAC, 50 / 60 Hz, 1 phase	Cabinet Full Load Amps (FLA)	11.3 A	11.4 A	11.4 A	11.5 A and 6.5 A (2 Power Inlet)
	Optional Outlets (FLA)	5 A			
	Cabinet Nominal Power (W)	163	211	260	308
	Heat Rejected, BTU per Hour	556	720	887	1051
Net Weight**		108 Kg (238 lbs)	156 Kg (344 lbs)	180 Kg (397 lbs)	228 Kg (503 lbs)
Shipping Weight**		140 Kg (308 lbs)	200 Kg (441 lbs)	237 Kg (522 lbs)	293 Kg (646 lbs)
Shipping Dimensions, Maximum (W x D x H)**		1120 x 900 x 1590 mm (44" x 35" x 62")	1400 x 900 x 1590 mm (55" x 35" x 62")	1720 x 900 x 1590 mm (68" x 35" x 62")	2200 x 900 x 1590 mm (87" x 35" x 62")
Shipping Volume, Maximum**		1.6 m ³ (56.6 ft ³)	2.0 m ³ (70.6 ft ³)	2.5 m ³ (88.2 ft ³)	3.3 m ³ (116.5 ft ³)

Specifications are subject to change without notice.

*Noise reading in open field condition / anechoic chamber. Noise reading in normal room varies by room size, layout, and background noise, but may reach roughly 3 dBA above these values.

**Cabinet only, excludes optional stand.

General Specifications, Airstream® Horizontal and Vertical Laminar Flow Cabinets, C-Height (Interior Height: 3 ft / 0.9 m)

Model	Nominal Size	External Dimension (W x D x H)	Internal Dimension (W x D x H)	Sound Emission per IEST-RP-CC002.2*	Fluorescent Lamp Intensity at Zero Ambient	Cabinet Full Load Amps (FLA)	Cabinet Nominal Power (W)	Heat Rejected, BTU per Hour	Shipping Weight**	Shipping Dimensions, Maximum (W x D x H)**	Shipping Volume, Maximum**
VERTICAL LAMINAR FLOW (Power Rating 8: 220-240 VAC, 50 / 60 Hz, 1 phase)											
LVS-4CG-F8 2120565	4 ft (1.2 m)	1340 x 774 x 1645 mm (52.8" x 30.5" x 64.8")	1270 x 739 x 905 mm (50.0" x 29.1" x 35.6")	52.5 dBA	904 Lux (84 fc)	7.5 A	213	727	243 Kg (536 lbs)	1490 x 900 x 1750 mm (58.7" x 35.4" x 68.9")	2.3 m ³ (81.2 ft ³)
LVS-6CG-F8 2120569	6 ft (1.8 m)	1950 x 774 x 1645 mm (76.8" x 30.5" x 64.8")	1880 x 739 x 905 mm (74.0" x 29.1" x 35.6")	53.2 dBA	1062 Lux (99 fc)	8.5 A	392	1337	330 Kg (661 lbs)	2070 x 900 x 1750 mm (81.5" x 35.4" x 68.9")	3.3 m ³ (116.5 ft ³)
LVS-8CG-F8 2120686	8 ft (2.4 m)	2520 x 774 x 1645 mm (99.2" x 30.5" x 64.8")	2450 x 739 x 905 mm (96.5" x 29.1" x 35.6")	59.8 dBA	1100 Lux (102 fc)	8.5 A and 3.5 A	422	1446	455 Kg (1003 lbs)	2720 x 950 x 1750 mm (107" x 37.4" x 68.9")	4.5 m ³ (158.9 ft ³)
LVG-4CG-F8 2120555	4 ft (1.2 m)	1340 x 774 x 1645 mm (52.8" x 30.5" x 64.8")	1270 x 739 x 915 mm (50.0" x 29.1" x 36.0")	52.5 dBA	904 Lux (84 fc)	7.5 A	213	727	243 Kg (536 lbs)	1490 x 900 x 1750 mm (58.7" x 35.4" x 68.9")	2.3 m ³ (81.2 ft ³)
LVG-6CG-F8 2120559	6 ft (1.8 m)	1950 x 774 x 1645 mm (76.8" x 30.5" x 64.8")	1880 x 739 x 915 mm (74.0" x 29.1" x 36.0")	53.2 dBA	1062 Lux (99 fc)	8.5 A	392	1337	330 Kg (661 lbs)	2070 x 900 x 1750 mm (81.5" x 35.4" x 68.9")	3.3 m ³ (116.5 ft ³)
VERTICAL LAMINAR FLOW (Power Rating 9: 110-130 VAC, 50 / 60 Hz, 1 phase)											
LVS-4CG-F9 2120605	4 ft (1.2 m)	1340 x 774 x 1645 mm (52.8" x 30.5" x 64.8")	1270 x 739 x 905 mm (50.0" x 29.1" x 35.6")	52.5 dBA	904 Lux (84 fc)	11.5 A	217	741	243 Kg (536 lbs)	1490 x 900 x 1750 mm (58.7" x 35.4" x 68.9")	2.3 m ³ (81.2 ft ³)
LVS-6CG-F9 2120609	6 ft (1.8 m)	1950 x 774 x 1645 mm (76.8" x 30.5" x 64.8")	1880 x 739 x 905 mm (74.0" x 29.1" x 35.6")	53.2 dBA	1062 Lux (99 fc)	13.5 A	400	1365	330 Kg (661 lbs)	2070 x 900 x 1750 mm (82" x 35.4" x 68.9")	3.3 m ³ (116.5 ft ³)
LVS-8CG-F9 2120687	8 ft (2.4 m)	2520 x 774 x 1645 mm (99.2" x 30.5" x 64.8")	2450 x 739 x 905 mm (96.5" x 29.1" x 35.6")	59.8 dBA	1100 Lux (102 fc)	14 A and 8A	434	1481	455 Kg (1003 lbs)	2720 x 950 x 1750 mm (107" x 37.4" x 68.9")	4.5 m ³ (158.9 ft ³)
LVG-4CG-F9 2120595	4 ft (1.2 m)	1340 x 774 x 1645 mm (52.8" x 30.5" x 64.8")	1270 x 739 x 915 mm (50.0" x 29.1" x 36.0")	52.5 dBA	904 Lux (84 fc)	11.5 A	217	741	243 Kg (536 lbs)	1490 x 900 x 1750 mm (58.7" x 35.4" x 68.9")	2.3 m ³ (81.2 ft ³)
LVG-6CG-F9 2120599	6 ft (1.8 m)	1950 x 774 x 1645 mm (76.8" x 30.5" x 64.8")	1880 x 739 x 915 mm (74.0" x 29.1" x 36.0")	53.2 dBA	1062 Lux (99 fc)	13.5 A	400	1365	330 Kg (661 lbs)	2070 x 900 x 1750 mm (81.5" x 35.4" x 68.9")	3.3 m ³ (116.5 ft ³)
HORIZONTAL LAMINAR FLOW (Power Rating 8: 220-240 VAC, 50 / 60 Hz, 1 phase)											
LHS-4CG-F8 2120545	4 ft (1.2 m)	1340 x 782 x 1422 mm (52.8" x 30.8" x 56.0")	1203 x 620 x 877 mm (47.4" x 24.4" x 34.5")	56.4 dBA	934 Lux (87 fc)	7.3 A	246	840	222 Kg (489 lbs)	1400 x 900 x 1590 mm (55.1" x 35.4" x 62.5")	2.0 m ³ (70.6 ft ³)
LHS-6CG-F8 2120549	6 ft (1.8 m)	1950 x 782 x 1422 mm (76.8" x 30.8" x 56.0")	1813 x 620 x 877 mm (71.4" x 24.4" x 34.5")	59.4 dBA	1001 Lux (93 fc)	8 A and 3 A	359	1225	301 Kg (664 lbs)	2200 x 900 x 1590 mm (86.6" x 35.4" x 62.5")	3.3 m ³ (116.5 ft ³)
LHS-8CG-F8 2120704	8 ft (2.4 m)	2520 x 782 x 1422 mm (99.2" x 30.8" x 56.0")	2383 x 620 x 877 mm (93.8" x 24.4" x 34.5")	62.3 dBA	1136 Lux (106 fc)	8.3 A and 3.3 A	388	1324	397 Kg (875 lbs)	2720 x 950 x 1590 mm (107.0" x 37.4" x 62.5")	4.1 m ³ (144.8 ft ³)
LHG-3CG-F8 2120533	3 ft (0.9 m)	1035 x 782 x 1422 mm (40.8" x 30.8" x 56.0")	898 x 631 x 877 mm (35.4" x 24.8" x 34.5")	54.2 dBA	1195 Lux (111 fc)	7 A	190	648	147 Kg (324 lbs)	1120 x 900 x 1590 mm (44" x 35.4" x 62.5")	1.6 m ³ (56.5 ft ³)
LHG-4CG-F8 2120535	4 ft (1.2 m)	1340 x 782 x 1422 mm (52.8" x 30.8" x 56.0")	1203 x 631 x 877 mm (47.4" x 24.8" x 34.5")	56.4 dBA	934 Lux (87 fc)	7.3 A	246	840	222 Kg (489 lbs)	1400 x 900 x 1590 mm (55.1" x 35.4" x 62.5")	2.0 m ³ (70.6 ft ³)
LHG-6CG-F8 2120539	6 ft (1.8 m)	1950 x 782 x 1422 mm (76.8" x 30.8" x 56.0")	1813 x 631 x 877 mm (71.4" x 24.8" x 34.5")	59.4 dBA	1001 Lux (93 fc)	8 A and 3 A	359	1225	301 Kg (664 lbs)	2200 x 900 x 1590 mm (86.6" x 35.4" x 62.5")	3.3 m ³ (116.5 ft ³)
HORIZONTAL LAMINAR FLOW (Power Rating 9: 110-130 VAC, 50 / 60 Hz, 1 phase)											
LHS-4CG-F9 2120585	4 ft (1.2 m)	1340 x 782 x 1422 mm (52.8" x 30.8" x 56.0")	1203 x 620 x 877 mm (47.4" x 24.4" x 34.5")	56.4 dBA	934 Lux (87 fc)	11.4 A	250	853	222 Kg (489 lbs)	1400 x 900 x 1590 mm (55.1" x 35.4" x 62.5")	2.0 m ³ (70.6 ft ³)
LHS-6CG-F9 2120589	6 ft (1.8 m)	1950 x 782 x 1422 mm (76.8" x 30.8" x 56.0")	1813 x 620 x 877 mm (71.4" x 24.4" x 34.5")	59.4 dBA	1001 Lux (93 fc)	11.5 A and 6.5 A	365	1245	301 Kg (664 lbs)	2200 x 900 x 1590 mm (86.6" x 35.4" x 62.5")	3.3 m ³ (116.5 ft ³)
LHS-8CG-F9 2120719	8 ft (2.4 m)	2520 x 782 x 1422 mm (99.2" x 30.8" x 56.0")	2383 x 620 x 877 mm (93.8" x 24.4" x 34.5")	62.3 dBA	1136 Lux (106 fc)	12 A and 6 A	394	1344	397 Kg (875 lbs)	2720 x 950 x 1590 mm (107.0" x 37.4" x 62.5")	4.1 m ³ (144.8 ft ³)
LHG-3CG-F9 2120573	3 ft (0.9 m)	1035 x 782 x 1422 mm (40.8" x 30.8" x 56.0")	898 x 631 x 877 mm (35.4" x 24.8" x 34.5")	54.2 dBA	1195 Lux (111 fc)	11.3 A	193	659	147 Kg (324 lbs)	1120 x 900 x 1590 mm (44" x 35.4" x 62.5")	1.6 m ³ (56.5 ft ³)
LHG-4CG-F9 2120575	4 ft (1.2 m)	1340 x 782 x 1422 mm (52.8" x 30.8" x 56.0")	1203 x 631 x 877 mm (47.4" x 24.8" x 34.5")	56.4 dBA	934 Lux (87 fc)	11.4 A	250	853	222 Kg (489 lbs)	1400 x 900 x 1590 mm (55.1" x 35.4" x 62.5")	2.0 m ³ (70.6 ft ³)
LHG-6CG-F9 2120579	6 ft (1.8 m)	1950 x 782 x 1422 mm (76.8" x 30.8" x 56.0")	1813 x 631 x 877 mm (71.4" x 24.8" x 34.5")	59.4 dBA	1001 Lux (93 fc)	11.5 A and 6.5 A	365	1245	301 Kg (664 lbs)	2200 x 900 x 1590 mm (86.6" x 35.4" x 62.5")	3.3 m ³ (116.5 ft ³)
SPECIFICATIONS AVAILABLE FOR ALL MODELS AND SIZES											
Cabinet Construction	Main Body	1.2 mm (0.05") 18 gauge electro-galvanized steel with white oven-baked epoxy-polyester powder-coated finish									
	Work Zone	1.2 mm (0.05") 18-gauge stainless steel, grade 304, with 4B finish									
	Side Walls	LVG-LHG: UV absorbing tempered glass, 5 mm (0.2"), colorless and transparent LVS-LHS: 1.2 mm (0.05") 18 gauge stainless steel, grade 304, with 4B finish									
Average Airflow Velocity		0.45 m/s (90 fpm) at initial set point									
ULPA Filter Typical Efficiency		> 99.999% at particle size between 0.1 to 0.2 µm									
Electrical		Power Rating 8: 220-240 VAC, 50 / 60 Hz, 1 phase									
		Power Rating 9: 110-130 VAC, 50 / 60 Hz, 1 phase									

Specifications are subject to change without notice.

*Noise reading in open field condition / anechoic chamber. Noise reading in normal room varies by room size, layout, and background noise, but may reach roughly 3 dBA above these values.

**Cabinet only, excludes optional stand.

Product Matrix with ordering Item Codes

Product Matrix				220-240 VAC, 50/60 Hz		Old Models	110-130 VAC, 50/60 Hz		Old Models	
Laminar Flow Cabinets	Vertical	Stainless Steel Sides	2.25 ft Internal Height	2120381	LVS-3AG-F8	LVC-3A1/3	2120443	LVS-3AG-F9	LVC-3A2	
				2120382	LVS-4AG-F8	LVC-4A1/3	2120445	LVS-4AG-F9	LVC-4A2	
				2120759	LVS-4AG-S8		2120762	LVS-4AG-S9		
				2120383	LVS-5AG-F8	LVC-5A1/3	2120447	LVS-5AG-F9	LVC-5A2	
				2120384	LVS-6AG-F8	LVC-6A1/3	2120449	LVS-6AG-F9	LVC-6A2	
		2120760	LVS-6AG-S8		2120764	LVS-6AG-S9				
		3 ft Internal Height	2120565	LVS-4CG-F8	LVC-4C1/3	2120605	LVS-4CG-F9	LVC-4C2		
			2120569	LVS-6CG-F8	LVC-6C1/3	2120609	LVS-6CG-F9	LVC-6C2		
			2120686	LVS-8CG-F8	LVC-8C1/3	2120687	LVS-8CG-F9	LVC-8C2		
		Glass Sides	2.25 ft Internal Height	2120374	LVG-3AG-F8	AVC-3D1/3	2120435	LVG-3AG-F9	AVC-3D2	
	2120369			LVG-4AG-F8	AVC-4D1/3	2120437	LVG-4AG-F9	AVC-4D2		
	2120701			LVG-4AG-S8		2120761	LVG-4AG-S9			
	2120375			LVG-5AG-F8	AVC-5D1/3	2120439	LVG-5AG-F9	AVC-5D2		
	2120380			LVG-6AG-F8	AVC-6D1/3	2120441	LVG-6AG-F9	AVC-6D2		
	2120703		LVG-6AG-S8		2120763	LVG-6AG-S9				
	3 ft Internal Height		2120555	LVG-4CG-F8	AVC-4C1/3	2120595	LVG-4CG-F9	AVC-4C2		
			2120559	LVG-6CG-F8	AVC-6C1/3	2120599	LVG-6CG-F9	AVC-6C2		
	Horizontal		Stainless Steel Sides	2 ft Internal Height	2120377	LHS-3AG-F8	LHC-3A1/3	2120425	LHS-3AG-F9	LHC-3A2
					2120378	LHS-4AG-F8	LHC-4A1/3	2120427	LHS-4AG-F9	LHC-4A2
		2120379			LHS-5AG-F8	LHC-5A1/3	2120429	LHS-5AG-F9	LHC-5A2	
2120380		LHS-6AG-F8			LHC-6A1/3	2120431	LHS-6AG-F9	LHC-6A2		
2.5 ft Internal Height		2120463		LHS-3BG-F8	LHC-3B1/3	2120503	LHS-3BG-F9	LHC-3B2		
		2120465		LHS-4BG-F8	LHC-4B1/3	2120505	LHS-4BG-F9	LHC-4B2		
		2120467		LHS-5BG-F8	LHC-5B1/3	2120507	LHS-5BG-F9	LHC-5B2		
		2120469		LHS-6BG-F8	LHC-6B1/3	2120509	LHS-6BG-F9	LHC-6B2		
3 ft Internal Height		2120545		LHS-4CG-F8	LHC-4C1/3	2120585	LHS-4CG-F9	LHC-4C2		
		2120549		LHS-6CG-F8	LHC-6C1/3	2120589	LHS-6CG-F9	LHC-6C2		
2120704		LHS-8CG-F8	LHC-8C1/3	2120719	LHS-8CG-F9	LHC-8C2				
Glass Sides		2 ft Internal Height	2120387	LHG-3AG-F8	AHC-3D1/3	2120417	LHG-3AG-F9	AHC-3D2		
			2120368	LHG-4AG-F8	AHC-4D1/3	2120419	LHG-4AG-F9	AHC-4D2		
			2120372	LHG-5AG-F8	AHC-5D1/3	2120421	LHG-5AG-F9	AHC-5D2		
			2120373	LHG-6AG-F8	AHC-6D1/3	2120423	LHG-6AG-F9	AHC-6D2		
		2.5 ft Internal Height	2120453	LHG-3BG-F8	AHC-3B1/3	2120493	LHG-3BG-F9	AHC-3B2		
			2120455	LHG-4BG-F8	AHC-4B1/3	2120495	LHG-4BG-F9	AHC-4B2		
			2120457	LHG-5BG-F8	AHC-5B1/3	2120497	LHG-5BG-F9	AHC-5B2		
			2120459	LHG-6BG-F8	AHC-6B1/3	2120499	LHG-6BG-F9	AHC-6B2		
		3 ft Internal Height	2120533	LHG-3CG-F8	AHC-3C1/3	2120573	LHG-3CG-F9	AHC-3C2		
	2120535		LHG-4CG-F8	AHC-4C1/3	2120575	LHG-4CG-F9	AHC-4C2			
2120539	LHG-6CG-F8	AHC-6C1/3	2120579	LHG-6CG-F9	AHC-6C2					



LIFESCIENCES GROUP

Esco Micro Pte. Ltd. • 21 Changi South Street 1 • Singapore 486 777
 Tel +65 6542 0833 • Fax +65 6542 6920 • mail@escolifesciences.com
 www.escolifesciences.com

Esco Technologies, Inc. • 903 Sheehy Drive, Suite F, Horsham, PA 19044, USA
 Tel: +1 215-441-9661 • Fax 484-698-7757
 eti.admin@escolifesciences.com

Esco Lifesciences Group Offices: Bangladesh | China | Denmark | Germany | Hong Kong | India | Indonesia | Italy | Japan | Lithuania | Malaysia | Myanmar | Philippines | Russia | Singapore | South Africa | South Korea | Taiwan | Thailand | UAE | UK | USA | Vietnam