

ROTOFIX 32 A



Ⓝ DE	Bedienungsanleitung.....	9
Ⓝ EN	Operating Instructions.....	31
Ⓝ FR	Mode d'emploi	53
Ⓝ IT	Istruzioni per l'uso	75

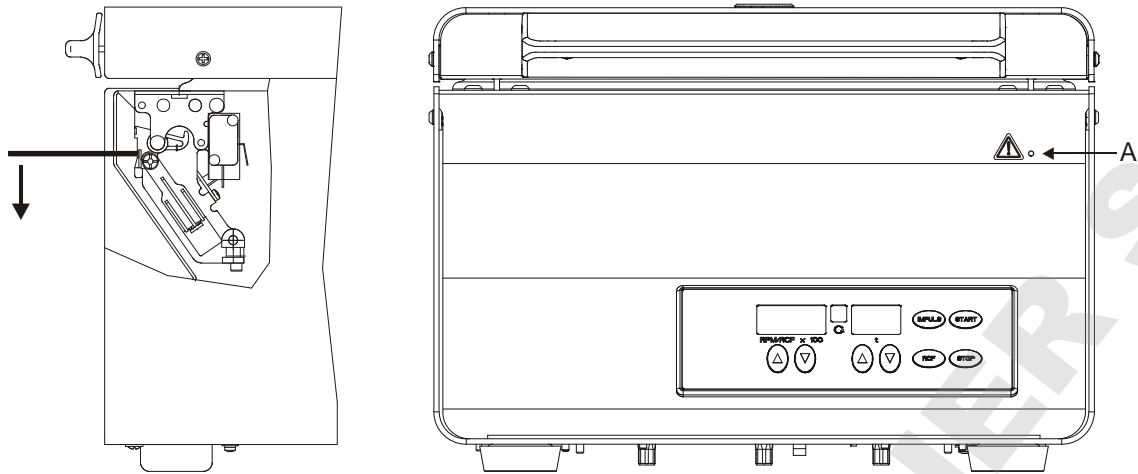

Fig. 1

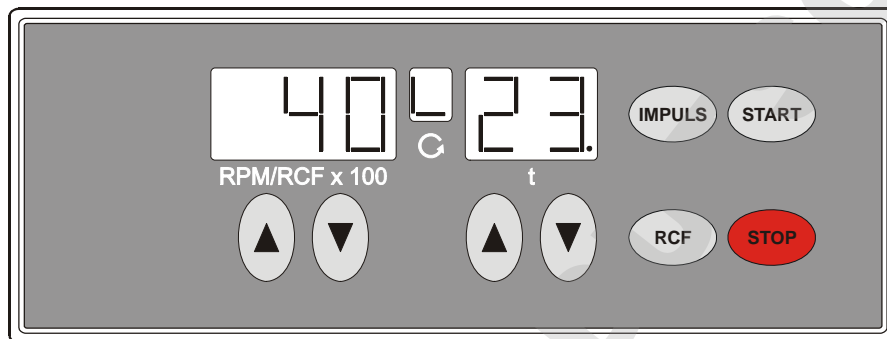

Fig. 2 ROTOFIX 32 A

EG-Konformitätserklärung
EC Declaration of conformity
Déclaration de conformité CE
Dichiarazione di conformità CE

des Herstellers / of the manufacturer / du fabricant / del costruttore
Andreas Heltich GmbH & Co. KG • Föhrenstraße 12 • D-78532 Tuttlingen • Germany

Hiermit erklären wir in alleiniger Verantwortung, dass das bezeichnete Gerät, inklusive dem mit dem Gerät konformitätsbewertetem Zubehör laut Zubehörliste der technischen Dokumentation dieses Geräts, der Richtlinie über In-vitro-Diagnostika 98/79/EG entspricht.

We hereby declare under our sole responsibility that the designated device and its accessories, which are listed in the technical documentation for this device and whose conformity has been assessed together with the device, conform to the Directive 98/79/EC on in vitro diagnostic medical devices.

Par la présente, nous déclarons sous notre seule responsabilité que l'appareil désigné, incluant ses accessoires attestés conformes d'après la liste des accessoires de la documentation technique du dit-appareil, répond à la directive 98/79/CE sur le diagnostic In-vitro.

Si dichiara nella nostra sola responsabilità, che l'apparecchiatura indicata, comprensiva dei conformi accessori come da elenco della documentazione tecnica di questa apparecchiatura, risponde alle direttive per Diagnostica In-Vitro 98/79/CE.

Geräteart / Type of device / Type d'appareil / Tipo di apparecchio:
Laborzentrifuge / Laboratory centrifuge / Centrifugeuse de laboratoire / Centrifuga di laboratorio

Typenbezeichnung / Type designation / Désignation du type / Denominazione del tipo:
ROTOFIX 32 A

Das Konformitätsbewertungsverfahren wurde nach Anhang III der Richtlinie 98/79/EG durchgeführt.

The conformity evaluation process was performed in accordance with appendix III of Directive 98/79/EC.

La procédure d'évaluation de la conformité a été réalisée conformément à l'annexe III de la directive 98/79/CE.

La procedura di valutazione di conformità è stata eseguita conformemente all'appendice III delle direttive 98/79/CE.

Folgende weitere europäische Richtlinien und Verordnungen wurden angewandt:

- Maschinenrichtlinie 2006/42/EG
- EMV-Richtlinie 2014/30/EU
- Niederspannungsrichtlinie 2014/35EU
- RoHS II Richtlinie 2011/65/EG (ohne Beteiligung einer benannten Stelle)
- Verordnung (EG) Nr. 1907/2006 (REACH) (ohne Beteiligung einer benannten Stelle)

Angewandte Normen:

Gemäß Liste der angewandten Normen, die Teil der Produktakte ist.

The following additional European directives and ordinances have been applied:

- Machinery Directive 2006/42/EC
- EMC directive 2014/30/EU
- Low voltage directive 2014/35EU
- RoHS II Directive 2011/65/EC (without involvement of a notified body)
- Ordinance (EC) No. 1907/2006 (REACH) (without involvement of a notified body)

Applied standards:

According to the list of applied standards, which is part of the product file.

Les autres directives et normes européennes suivantes ont été appliquées:

- Directive 2006/42/EG relative aux machines
- Directive CEM 2014/30/EU
- Directive basse tension 2014/35EU
- Directive RoHS II 2011/65/CE (sans participation d'un organisme désigné)
- Directive (CE) no. 1907/2006 (REACH) (sans participation d'un organisme désigné)

Normes appliquées:

Conformément à la liste des normes appliquées relatives aux cycles du produit.

Sono state applicate le seguenti direttive e regolamenti europei:

- Direttive per macchine 2006/42/CE
- Direttive per compatibilità elettromagnetica 2014/30/EU
- Direttive per basse tensioni 2014/35EU
- RoHS II direttive 2011/65/CE (senza concorso di un citato collaboratore)
- Regolamento (CE) n. 1907/2006 (REACH) (senza concorso di un citato collaboratore)

Norme applicate:

Conformemente alla lista delle norme applicate, che sono parte degli atti del prodotto.

Tuttlingen, 2016-07-20



Klaus-Günter Eberle
Geschäftsführer, Manager,
Directeur, Gerente



Hettich
LAB TECHNOLOGY

Standards and regulations which apply to this device

The device is a high-end technical product. It is subject to extensive testing and certification procedures according to the following standards and regulations in their respectively valid version:

Electrical and mechanical safety for design and final testing:

Standard series: IEC 61010 (conform to standards of DIN EN 61010)

- IEC 61010-1 "Safety requirements for electrical equipment for measurement, control, and laboratory use - Part 1: General requirements" (Pollution Degree 2, Excess-voltage category II)
- IEC 61010-2-010 „Safety requirements for electrical equipment for measurement, control and laboratory use - Part 2-010: Particular requirements for laboratory equipment for the heating of Materials" (only valid for centrifuges with heating)
- IEC 61010-2-011 „Safety requirements for electrical equipment for measurement, control and laboratory use - Part 2-011: Particular requirements for refrigerating equipment" (only valid for centrifuges with cooling)
- IEC 61010-2-020 "Safety requirements for electrical equipment for measurement, control, and laboratory use - Part 2-020: Particular requirements for laboratory centrifuges"
- IEC 61010-2-101 "Safety requirements for electrical equipment for measurement, control and laboratory use - Part 2-101: Particular requirements for in vitro diagnostic (IVD) medical equipment"

Electromagnetic Compatibility:

- EN 61326-1 "Electrical equipment for measurement, control and laboratory use - EMC requirements - Part 1: General requirements"

Risk management:

- DIN EN ISO 14971 "Application of risk management to medical devices"

Restriction of Hazardous Substances (RoHS II):

- EN 50581 "Technical documentation for assessing electric and electronic devices with regard to the restriction of hazardous substances"

European directives applied for conformity assessment procedures:

- In vitro diagnostic device directive 98/79/EG
EC conformity assessment procedure according to annex III "EC DECLARATION OF CONFORMITY" – self-declaration by the manufacturer
- Directive 2011/65/EU for the restriction of use of certain hazardous substances in electric and electronic devices. Carrying out the EC conformity assessment process is the sole responsibility of the manufacturer, without the involvement of a notified body.

Applied medical device regulations outside Europe:

- **USA:** QSR, 21CFR 820 "CFR Title 21 - Food and Drugs: TITLE 21 - FOOD AND DRUGS, CHAPTER I - FOOD AND DRUG ADMINISTRATION DEPARTMENT OF HEALTH AND HUMAN SERVICES, SUBCHAPTER H - MEDICAL DEVICES, Part 820 QUALITY SYSTEM REGULATIONS"
- **Canada:** CMDR, SOR/98-282 "Medical Devices Regulations"

Certified quality management system according to

- ISO 9001 "Quality management systems – Requirements"
- ISO13485 "Medical devices - Quality management systems - Requirements for regulatory purposes"

Environmental management system according to

- ISO 14001 "Environmental management systems - Requirements with guidance for use"

Normes et règles en vigueur pour cet appareil

Cet appareil est un produit avec un très haut niveau technique. Il est soumis à des vastes procédures de vérification et de certification, d'après les normes et prescriptions suivantes, dans leur version actuelle :

Sécurité électrique et mécanique pour la construction et l'inspection finale :

Série de normes : IEC 61010 (correspond à la série de norme DIN EN 61010)

- IEC 61010-1 "Règles de sécurité pour appareils électriques de mesurage, de régulation et de laboratoire - partie 1 : Prescriptions générales" (niveau de saleté 2, catégorie de surtension II)
- IEC 61010-2-010 "Règles de sécurité pour appareils électriques de mesurage, de régulation et de laboratoire – partie 2-010 : Prescriptions particulières pour appareils de laboratoire utilisés pour l'échauffement des matières" (seulement valable pour centrifugeuses avec chauffage)
- IEC 61010-2-011 "Règles de sécurité pour appareils électriques de mesurage, de régulation et de laboratoire – partie 2-011 : Prescriptions particulières applicables aux refroidisseurs" (valable seulement pour centrifugeuses avec refroidissement)
- IEC 61010-2-020 "Règles de sécurité pour appareils électriques de mesurage, de régulation et de laboratoire – partie 2-020 : Prescriptions particulières pour centrifugeuses de laboratoire"
- IEC 61010-2-101 "Règles de sécurité pour appareils électriques de mesurage, de régulation et de laboratoire – partie 2-101 : Prescriptions particulières pour les appareils médicaux de diagnostic in vitro" (DIV)

Compatibilité électromagnétique :

- EN 61326-1 "Matériel électrique de mesure, de commande et de laboratoire – Exigences relatives à la CEM - partie 1 : Exigences générales"

Gestion des risques :

- DIN EN ISO 14971 "Application de la gestion des risques aux dispositifs médicaux"

Restrictions relatives aux substances dangereuses (RoHS II):

- Norme européenne 50581 „Documentation technique pour l'évaluation des produits électriques et électroniques par rapport à la restriction des substances dangereuses“

Directives européennes valables pour des procédures d'évaluation de la conformité :

- directive 98/79/EC relative aux dispositifs médicaux de diagnostic in vitro
procédure d'évaluation de la conformité CE d'après l'annexe III "Déclaration CE de conformité" – déclaration spécifique du fabricant
- Directives 2011/65/UE concernant les restrictions relatives à l'utilisation de certaines substances dangereuses dans les appareils électriques et électroniques. La procédure d'évaluation de la conformité CE est sous la seule responsabilité du fabricant, sans participation d'un organisme désigné.

Directives pour dispositifs médicaux, valables en dehors de l'Europe :

- **USA** : QSR, 21CFR 820 "CFR Title 21 - Food and Drugs : TITLE 21- FOOD AND DRUGS, CHAPTER I - FOOD AND DRUG ADMINISTRATION DEPARTMENT OF HEALTH AND HUMAN SERVICES, SUBCHAPTER H - MEDICAL DEVICES, Part 820 QUALITY SYSTEM REGULATIONS"
- **Canada**: CMDR, SOR/98-282 "Medical Devices Regulations"

Système de management de la qualité certifié d'après

- ISO 9001 "Systèmes de management de la qualité - Prescriptions"
- ISO13485 "Dispositifs médicaux - Systèmes de management de la qualité - Exigences à des fins réglementaires"

Système de management environnemental d'après

- ISO 14001 "Systèmes de management environnemental - Spécification avec description pour application"

Norme e direttive valide per questo apparecchio

L'apparecchio è un dispositivo di elevatissimo livello tecnico. È sottoposto a numerosi procedimenti di collaudo e certificazione, in conformità alle seguenti norme e direttive nella corrispondente versione di validità:

Sicurezza elettrica e meccanica per la costruzione ed il collaudo finale:

Serie di norma: IEC 61010 (corrisponde alla serie di norma DIN EN 61010)

- IEC 61010-1 "Norme di sicurezza per apparecchiature elettriche di misurazione, di comando, di regolazione e di laboratorio - parte 1: Requisiti generali" (grado di imbrattamento 2, Categoria di sovratensione II)
- IEC 61010-2 -010 "Norme di sicurezza per apparecchiature elettriche di misurazione, di comando, di regolazione e di laboratorio - parte 2-010: Requisiti particolari per le apparecchiature di laboratorio per il riscaldamento di materiali" (valido solo per centrifughe con riscaldamento)
- IEC 61010-2-011 „Norme di sicurezza per apparecchiature elettriche di misurazione, di comando, di regolazione e di laboratorio - parte 2-011: Requisiti particolari per apparecchiature di raffreddamento“ (valido solo per centrifughe con raffreddamento)
- IEC 61010-2 -020 "Norme di sicurezza per apparecchiature elettriche di misurazione, di comando, di regolazione e di laboratorio - parte 2-020: Requisiti particolari per centrifughe di laboratorio"
- IEC 61010-2 -101 "Norme di sicurezza per apparecchiature elettriche di misurazione, di comando, di regolazione e di laboratorio - parte 2-101: Requisiti particolari per la diagnostica In-vitro (IVD) apparecchiature medicali"

Compatibilità elettromagnetica:

- EN 61326-1 "Apparecchiature elettriche di misurazione, di comando, di regolazione e di laboratorio - requisiti di compatibilità elettromagnetica - parte 1: Requisiti generali"

Gestione dei rischi:

- DIN EN ISO 14971 "Applicazione della gestione dei rischi ai dispositivi medici"

Restrizione per prodotti pericolosi (RoHS II):

- EN 50581 „Documentazione tecnica per la stesura di un protocollo di valutazione delle apparecchiature elettriche ed elettroniche per quanto riguarda la restrizione per prodotti pericolosi“

Direttive europee che sono di validità per il procedimento di valutazione della conformità:

- Direttive 98/79/CE per apparecchiature di diagnosi In-vitro
Procedimento di valutazione di conformità CE conforme all'appendice III "Dichiarazione di conformità CE" – Dichiarazione propria del costruttore
- Direttive 2011/65/EU per la restrizione di impiego di particolari prodotti pericolosi nelle apparecchiature elettriche ed elettroniche. Il procedimento di valutazione della conformità CE avviene al riguardo nella sola responsabilità del costruttore, senza concorso di un citato collaboratore.

Direttive valide al di fuori dell'ambito europeo per i prodotti medicali:

- **USA:** QSR, 21CFR 820 "CFR Title 21 - Food and Drugs: TITLE 21- FOOD AND DRUGS, CHAPTER I - FOOD AND DRUG ADMINISTRATION DEPARTMENT OF HEALTH AND HUMAN SERVICES, SUBCHAPTER H - MEDICAL DEVICES, Part 820 QUALITY SYSTEM REGULATIONS"
- **Kanada:** CMDR, SOR/98-282 "Medical Devices Regulations"

Certificato sistema di gestione della qualità, conforme a

- ISO 9001 "Requisiti per sistemi di gestione qualità"
- ISO13485 "Sistemi di gestione qualità per prodotti medicali - Requisiti per impieghi di regolazione"

Sistema di gestione ambientale, conforme a

- ISO 14001 "Sistemi di gestione ambientale - Specificazione con istruzioni per l'applicazione"

Andreas Hettich GmbH & Co. KG
Föhrenstraße 12, D-78532 Tuttlingen / Germany
Phone +49 (0)7461 / 705-0
Fax +49 (0)7461 / 705-1125
info@hettichlab.com, service@hettichlab.com
www.hettichlab.com



© 2006 by Andreas Hettich GmbH & Co. KG

All rights reserved. No part of this publication may be reproduced without the prior written permission of the copyright owner.

Änderungen vorbehalten! , Modifications reserved! , Sous réserve de modifications ! , Con riserva di modifiche!

AB1206DEENFRIT / Rev. 11

Inhaltsverzeichnis

1	Bestimmungsgemäße Verwendung.....	11
2	Restrisiken.....	11
3	Technische Daten.....	11
4	Sicherheitshinweise.....	12
5	Bedeutung der Symbole.....	14
6	Lieferumfang.....	15
7	Auspacken der Zentrifuge.....	15
8	Transport und Lagerung.....	15
8.1	Transport.....	15
8.2	Lagerung.....	15
9	Inbetriebnahme.....	16
10	Deckel öffnen und schließen.....	16
10.1	Deckel öffnen.....	16
10.2	Deckel schließen.....	16
11	Ein- und Ausbau des Rotors.....	17
11.1	Rotor mit Spannmutter.....	17
11.2	Rotor ohne Spannmutter.....	17
11.2.1	Ein- und Ausbau der Nabe.....	17
11.2.2	Einsetzen und Herausnehmen des Rotors.....	17
12	Gehänge in den Rotor einsetzen und herausnehmen.....	18
13	Adapter in die Gehänge einsetzen und herausnehmen.....	18
14	Adapter mit Positionierungszapfen in Gehänge einsetzen.....	18
15	Beladen des Rotors.....	19
16	Verschließen von Bio-Sicherheitssystemen.....	20
17	Bedien- und Anzeigeelemente.....	21
17.1	Symbole des Bedienfeldes.....	21
17.2	Tasten und Einstellmöglichkeiten.....	21
18	Bremsstufe einstellen.....	22
19	Zentrifugerradius einstellen.....	22
20	Zentrifugation.....	22
20.1	Zentrifugation mit Zeitvorwahl.....	23
20.2	Dauerlauf.....	23
20.3	Kurzzeitzentrifugation.....	23
20.4	Anzeige der relativen Zentrifugalbeschleunigung (RCF).....	23
21	Akustisches Signal.....	24
22	Relative Zentrifugalbeschleunigung (RCF).....	24
23	Zentrifugation von Stoffen oder Stoffgemischen mit einer höheren Dichte als 1,2 kg/dm ³	25
24	Rotorerkennung.....	25
25	Notentriegelung.....	25
26	Pflege und Wartung.....	26
26.1	Zentrifuge (Gehäuse, Deckel und Schleuderraum).....	26
26.1.1	Oberflächenreinigung und -pflege.....	26
26.1.2	Oberflächendesinfektion.....	26

26.1.3	Entfernen radioaktiver Verunreinigungen.....	26
26.2	Rotoren und Zubehör.....	27
26.2.1	Reinigung und Pflege	27
26.2.2	Desinfektion	27
26.2.3	Entfernen radioaktiver Verunreinigungen.....	28
26.2.4	Tragzapfen.....	28
26.2.5	Rotoren und Zubehör mit begrenzter Verwendungsdauer.....	28
26.3	Autoklavieren	28
26.4	ZentrifugiergefäÙe.....	28
27	Störungen.....	29
28	Netzeingangssicherungen wechseln.....	30
29	Rücksendung von Geräten.....	30
30	Entsorgung.....	30
31	Anhang / Appendix.....	97
31.1	Rotoren und Zubehör / Rotors and accessories.....	97

1 Bestimmungsgemäße Verwendung

Bei dem vorliegenden Gerät handelt es sich um ein Medizinprodukt (Laborzentrifuge) im Sinne der IVD-Richtlinie 98/79/EG.

Die Zentrifuge dient zum Trennen von Stoffen bzw. Stoffgemischen mit einer Dichte von max. 1,2 kg/dm³. Darunter fallen insbesondere Proben zur Vorbereitung für In-vitro diagnostische Zwecke in der Humanmedizin.

Die Zentrifuge ist nur für diesen Verwendungszweck bestimmt.

Eine andere oder darüber hinausgehende Benutzung gilt als nicht bestimmungsgemäß. Für hieraus entstehende Schäden haftet die Firma Andreas Hettich GmbH & Co. KG nicht.

Zur bestimmungsgemäßen Verwendung gehört auch das Beachten aller Hinweise aus der Bedienungsanleitung und die Einhaltung der Inspektions- und Wartungsarbeiten.

2 Restrisiken

Das Gerät ist nach dem Stand der Technik und den anerkannten sicherheitstechnischen Regeln gebaut. Bei unsachgemäßer Verwendung und Behandlung können Gefahren für Leib und Leben des Benutzers oder Dritter bzw. Beeinträchtigungen an dem Gerät oder an anderen Sachwerten entstehen. Das Gerät ist nur für die bestimmungsgemäße Verwendung, und nur in sicherheitstechnisch einwandfreiem Zustand zu benutzen.

Störungen, die die Sicherheit beeinträchtigen können, sind umgehend zu beseitigen.

3 Technische Daten

Hersteller	Andreas Hettich GmbH & Co. KG D-78532 Tuttlingen	
Modell	ROTOFIX 32 A	
Typ	1206 1206-34	1206-01 1206-33
Netzspannung ($\pm 10\%$)	208 – 240 V 1~	100 – 127 V 1~
Netzfrequenz	50 – 60 Hz	50 – 60 Hz
Anschlusswert	300 VA	300 VA
Stromaufnahme	1.4 A	3.0 A
Kapazität max.	4 x 100 ml / 32 x 15 ml	
zulässige Dichte	1.2 kg/dm ³	
Drehzahl (RPM)	6000	
Beschleunigung (RCF)	4226	
Kinetische Energie	3160 Nm	
Prüfpflicht (DGUV Regel 100 – 500)	nein	
Umgebungsbedingungen (EN / IEC 61010-1)	nur in Innenräumen bis zu 2000 m über Normal-Null 2°C bis 40°C maximale relative Luftfeuchte 80% für Temperaturen bis 31°C, linear abnehmend bis 50% relativer Luftfeuchte bei 40°C.	
– Aufstellungsort		
– Höhe		
– Umgebungstemperatur		
– Luftfeuchtigkeit		
– Überspannungskategorie (IEC 60364-4-443)	II	
– Verschmutzungsgrad	2	
Geräteschutzklasse	I	
nicht für den Einsatz in explosionsgefährdeter Umgebung geeignet.		
EMV		
– Störaussendung, Störfestigkeit	EN / IEC 61326-1, Klasse B	FCC Class B
Geräuschpegel (rotorabhängig)	≤ 57 dB(A)	
Abmessungen		
– Breite	366 mm	
– Tiefe	430 mm	
– Höhe	257 mm	
Gewicht	23 kg	

4 Sicherheitshinweise



Werden nicht alle Hinweise in dieser Bedienungsanleitung befolgt, kann beim Hersteller kein Gewährleistungsanspruch geltend gemacht werden.



- Die Zentrifuge ist so aufzustellen, dass sie standsicher betrieben werden kann.
- Vor Benutzung der Zentrifuge unbedingt den Rotor auf festen Sitz prüfen.
- Während eines Zentrifugationslaufes dürfen sich gemäß EN / IEC 61010-2-020, in einem Sicherheitsbereich von 300 mm um die Zentrifuge herum, keine Personen, Gefahrstoffe und Gegenstände befinden.
- Rotoren, Gehänge und Zubehörteile, die starke Korrosionsspuren oder mechanische Schäden aufweisen, oder deren Verwendungsdauer abgelaufen ist, dürfen nicht mehr verwendet werden.
- Die Zentrifuge darf nicht mehr in Betrieb genommen werden, wenn der Schleuderraum sicherheitsrelevante Schäden aufweist.
- Bei Ausschwingrotoren müssen die Tragzapfen regelmäßig gefettet werden (Hettich-Schmierfett Nr. 4051), um ein gleichmäßiges Ausschwingen der Gehänge zu gewährleisten.
- Bei Zentrifugen ohne Temperaturregelung kann es bei erhöhter Raumtemperatur und/oder bei häufigem Gebrauch des Gerätes zur Erwärmung des Schleuderraums kommen. Eine temperaturbedingte Veränderung des Probenmaterials kann deshalb nicht ausgeschlossen werden.

- **Vor Inbetriebnahme der Zentrifuge ist die Bedienungsanleitung zu lesen und zu beachten. Nur Personen, die die Bedienungsanleitung gelesen und verstanden haben, dürfen das Gerät bedienen.**
- Neben der Bedienungsanleitung und den verbindlichen Regelungen der Unfallverhütung sind auch die anerkannten fachtechnischen Regeln für sicherheits- und fachgerechtes Arbeiten zu beachten. Die Bedienungsanleitung ist um Anweisungen aufgrund bestehender nationaler Vorschriften des Verwenderlandes zur Unfallverhütung und zum Umweltschutz zu ergänzen.
- Die Zentrifuge ist nach dem Stand der Technik gebaut und betriebssicher. Es können aber von ihr Gefahren für den Benutzer oder Dritte ausgehen, wenn sie nicht von geschultem Personal oder unsachgemäß oder zu nicht bestimmungsgemäßem Gebrauch eingesetzt wird.
- Die Zentrifuge darf während des Betriebs nicht bewegt oder angestoßen werden.
- Im Störfall bzw. bei der Notentriegelung nie in den sich drehenden Rotor greifen.
- Um Schäden durch Kondensat zu vermeiden, muss bei Wechsel von einem kalten in einen warmen Raum, die Zentrifuge entweder mindestens 3 Stunden im warmen Raum aufwärmen bevor sie an das Netz angeschlossen werden darf oder 30 Minuten im kalten Raum warmlaufen.
- Es dürfen nur die vom Hersteller für dieses Gerät zugelassenen Rotoren und das zugelassene Zubehör verwendet werden (siehe Kapitel "Anhang/Appendix, Rotoren und Zubehör/Rotors and accessories"). Bevor Zentrifugiergefäße verwendet werden, die nicht in Kapitel "Anhang/Appendix, Rotoren und Zubehör/Rotors and accessories" aufgeführt sind, hat sich der Benutzer beim Hersteller zu vergewissern, ob diese verwendet werden dürfen.
- Der Rotor der Zentrifuge darf nur entsprechend dem Kapitel "Beladen des Rotors" beladen werden.
- Bei der Zentrifugation mit maximaler Drehzahl darf die Dichte der Stoffe oder Stoffgemische $1,2 \text{ kg/dm}^3$ nicht überschreiten.
- Zentrifugationen mit unzulässiger Unwucht sind nicht erlaubt.
- Die Zentrifuge darf nicht in explosionsgefährdeter Umgebung betrieben werden.
- Eine Zentrifugation mit:
 - brennbaren oder explosiven Materialien
 - Materialien, die chemisch mit hoher Energie miteinander reagieren ist verboten.

- Bei der Zentrifugation von gefährlichen Stoffen bzw. Stoffgemischen, die toxisch, radioaktiv oder mit pathogenen Mikroorganismen verseucht sind, sind durch den Benutzer geeignete Maßnahmen zu treffen. Es müssen grundsätzlich Zentrifugiergefäße mit speziellen Schraubverschlüssen für gefährliche Substanzen verwendet werden. Bei Materialien der Risikogruppe 3 und 4 ist zusätzlich zu den verschließbaren Zentrifugiergefäßen ein Bio-Sicherheitssystem zu verwenden (siehe Handbuch "Laboratory Bio-safety Manual" der Weltgesundheitsorganisation).
Bei einem Bio-Sicherheitssystem verhindert eine Bioabdichtung (Dichtungsring) das Austreten von Tröpfchen und Aerosolen.
Wird das Gehänge eines Bio-Sicherheitssystems ohne den Deckel verwendet, muss der Dichtungsring vom Gehänge entfernt werden, um eine Beschädigung des Dichtungsringes während des Zentrifugationslaufes zu vermeiden.
Beschädigte Bio-Sicherheitssysteme sind nicht mehr mikrobiologisch dicht.
Ohne Verwendung eines Bio-Sicherheitssystems ist eine Zentrifuge im Sinne der Norm EN / IEC 61010-2-020 nicht mikrobiologisch dicht.
Beim Schließen eines Bio-Sicherheitssystems sind die Anweisungen in Kapitel "Verschließen von Bio-Sicherheitssystemen" zu befolgen.
Lieferbare Bio-Sicherheitssysteme siehe Kapitel "Anhang/Appendix, Rotoren und Zubehör/Rotors and accessories". Im Zweifelsfall sind entsprechende Informationen beim Hersteller einzuholen.
- Der Betrieb der Zentrifuge mit stark korrodierenden Stoffen, welche die mechanische Festigkeit von Rotoren, Gehängen und Zubehörteilen beeinträchtigen können, ist nicht erlaubt.
- Reparaturen dürfen nur von einer vom Hersteller autorisierten Person ausgeführt werden.
- Es dürfen nur Originalersatzteile und zugelassenes Originalzubehör der Firma Andreas Hettich GmbH & Co. KG verwendet werden.
- Es gelten die folgenden Sicherheitsbestimmungen:
EN / IEC 61010-1 und EN / IEC 61010-2-020 sowie deren nationalen Abweichungen.
- Die Sicherheit und Zuverlässigkeit der Zentrifuge ist nur dann gewährleistet, wenn:
 - die Zentrifuge nach der Bedienungsanleitung betrieben wird.
 - die elektrische Installation, am Aufstellungsort der Zentrifuge, den Anforderungen von EN / IEC Festlegungen entspricht.
- Die Erfüllung länderspezifischer Vorgaben zur Arbeitssicherheit bezüglich des Einsatzes von Laborzentrifugen an den vom Betreiber dafür vorgesehenen Arbeitsplätzen liegt im Verantwortungsbereich des Betreibers.

5 Bedeutung der Symbole



Symbol am Gerät:
Achtung, allgemeine Gefahrenstelle.



Symbol am Gerät:
Bedienungsanleitung beachten.
Dieses Symbol verweist darauf hin, dass der Anwender die bereitgestellte Bedienungsanleitung beachten muss.



Symbol in diesem Dokument:
Achtung, allgemeine Gefahrenstelle.
Dieses Symbol kennzeichnet sicherheitsrelevante Hinweise und deutet auf mögliche gefährliche Situationen hin.
Das Nichtbeachten dieser Hinweise kann zu Sach- und Personenschäden führen.



Symbol am Gerät und in diesem Dokument:
Warnung vor Biogefährdung.



Symbol in diesem Dokument:
Dieses Symbol deutet auf wichtige Sachverhalte hin.



Symbol am Gerät und in diesem Dokument:
Symbol für die getrennte Sammlung von Elektro- und Elektronikgeräten, gemäß der Richtlinie 2002/96/EG (WEEE). Das Gerät gehört zur Gruppe 8 (Medizinische Geräte).
Verwendung in den Ländern der Europäischen Union sowie in Norwegen und der Schweiz.



Symbol auf der Verpackung:
Diese Seite oben.



Symbol auf der Verpackung:
Die Transportverpackung muss innerhalb des angezeigten Luftfeuchtigkeitsbereichs (10% - 80%) gelagert, transportiert und gehandhabt werden.



Symbol auf der Verpackung:
Die Versandverpackung muss innerhalb des angezeigten Temperaturbereichs (-20°C - +60°C) gelagert, transportiert und gehandhabt werden.



Symbol auf der Verpackung:
Die Transportverpackung muss von Regen ferngehalten werden und in trockener Umgebung gehalten werden.



Symbol auf der Verpackung:
Zerbrechlich, Vorsichtig behandeln.

6 Lieferumfang

Folgendes Zubehör wird mit der Zentrifuge geliefert:

- 1 Anschlusskabel
- 2 Sicherungen
- 1 Schmierfett für Tragzapfen
- 1 Sechskantstiftschlüssel
- 1 Entriegelungsstift
- 1 Hinweisblatt Transportsicherung
- 1 Bedienungsanleitung

Rotor(en) und das entsprechende Zubehör werden je nach Bestellung mitgeliefert.

7 Auspacken der Zentrifuge

- Den Karton nach oben abheben und die Polsterung entfernen.

-  Nicht an der Griffleiste des Deckels anheben.
Das Gewicht der Zentrifuge beachten, siehe Kapitel "Technische Daten".

Die Zentrifuge, mit der angemessenen Anzahl von Helfern, an beiden Seiten anheben und auf den Labortisch stellen.

8 Transport und Lagerung

8.1 Transport

-  Die Transportsicherung muss, vor dem Transport des Gerätes, eingebaut werden.

Beim Transport des Gerätes und des Zubehörs müssen folgende Umgebungsbedingungen eingehalten werden:

- Umgebungstemperatur: -20°C bis $+60^{\circ}\text{C}$
- Relative Luftfeuchtigkeit: 10% bis 80%, nicht kondensierend

8.2 Lagerung

-  Das Gerät und das Zubehör dürfen nur in geschlossenen und trockenen Räumen gelagert werden.

Bei der Lagerung des Gerätes und des Zubehörs müssen folgende Umgebungsbedingungen eingehalten werden:

- Umgebungstemperatur: -20°C bis $+60^{\circ}\text{C}$
- Relative Luftfeuchtigkeit: 10% bis 80%, nicht kondensierend

9 Inbetriebnahme

- Die Transportsicherung am Gehäuseboden entfernen, siehe Hinweisblatt "Transportsicherung".
- **Die Zentrifuge an einem geeigneten Platz standsicher aufstellen und nivellieren. Bei der Aufstellung ist der geforderte Sicherheitsbereich gemäß EN / IEC 61010-2-020, von 300 mm um die Zentrifuge herum, einzuhalten.**



Während eines Zentrifugationslaufes dürfen sich gemäß EN / IEC 61010-2-020, in einem Sicherheitsbereich von 300 mm um die Zentrifuge herum, keine Personen, Gefahrstoffe und Gegenstände befinden.

- Lüftungsöffnungen dürfen nicht zugestellt werden.
Es muss ein Abstand von 300 mm zu den Lüftungsschlitzen und Lüftungsöffnungen der Zentrifuge eingehalten werden.
- Prüfen, ob die Netzspannung mit der Angabe auf dem Typenschild übereinstimmt.
- Die Zentrifuge mit dem Netzkabel an eine genormte Netzsteckdose anschließen. Anschlusswert siehe Kapitel "Technische Daten".
- Den Netzschalter einschalten. Schalterstellung "I".
Die zuletzt benutzten Zentrifugierdaten werden angezeigt.
- Den Deckel öffnen.

10 Deckel öffnen und schließen

10.1 Deckel öffnen



Der Deckel lässt sich nur öffnen, wenn die Zentrifuge eingeschaltet ist und der Rotor stillsteht.
Sollte dies nicht möglich sein, siehe Kapitel "Notentriegelung".

- Die Griffleiste am Deckel nach oben schwenken. In der Rotationsanzeige  leuchtet das Symbol "L" (Deckel geöffnet).
- Den Deckel öffnen.

10.2 Deckel schließen



Den Deckel nicht zuschlagen.

- Den Deckel auflegen und die Griffleiste am Deckel nach unten schwenken. In der Rotationsanzeige  leuchtet das Symbol "—" (Deckel geschlossen).

11 Ein- und Ausbau des Rotors

11.1 Rotor mit Spannmutter

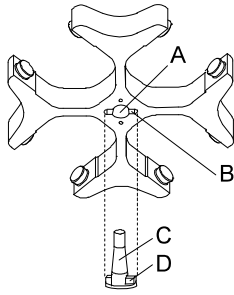

Einbau des Rotors:



Schmutzpartikel zwischen der Motorwelle und dem Rotor verhindern einen einwandfreien Sitz des Rotors und verursachen einen unruhigen Lauf.

- Die Motorwelle (C) und die Bohrung des Rotors (A) reinigen und anschließend die Motorwelle leicht einfetten.
- Den Rotor vertikal auf die Motorwelle aufsetzen. Der Mitnehmer der Motorwelle (D) muss sich in der Nut des Rotors (B) befinden. Auf dem Rotor ist die Ausrichtung der Nut gekennzeichnet.
- Die Spannmutter des Rotors mit dem mitgelieferten Schlüssel durch Drehen im Uhrzeigersinn anziehen.
- Den Rotor auf festen Sitz prüfen.

Ausbau des Rotors:

- Die Spannmutter durch Drehen entgegen dem Uhrzeigersinn lösen und bis zum Abhebe-Druckpunkt drehen. Nach Überwindung des Abhebe-Druckpunkts löst sich der Rotor vom Konus der Motorwelle.
- Die Spannmutter drehen, bis sich der Rotor von der Motorwelle abheben lässt.

11.2 Rotor ohne Spannmutter

11.2.1 Ein- und Ausbau der Nabe

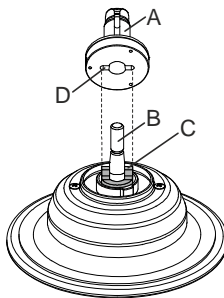

Einbau der Nabe:

- Die Nabe (A) vertikal auf die Motorwelle (B) aufsetzen. Der Mitnehmer (C) an der Motorwelle muss sich in der Nut (D) der Nabe befinden.
- Die Spannmutter der Nabe mit dem mitgelieferten Sechskant-Stiftschlüssel durch Drehen im Uhrzeigersinn anziehen.
- Die Nabe auf festen Sitz prüfen.

Ausbau der Nabe:

- Den Rotor herausnehmen.
- Die Spannmutter der Nabe durch Drehen entgegen dem Uhrzeigersinn lösen und bis zum Abhebe-Druckpunkt drehen. Nach Überwindung des Abhebe-Druckpunkts löst sich die Nabe vom Konus der Motorwelle.
- Die Spannmutter drehen, bis sich die Nabe von der Motorwelle abheben lässt.

11.2.2 Einsetzen und Herausnehmen des Rotors

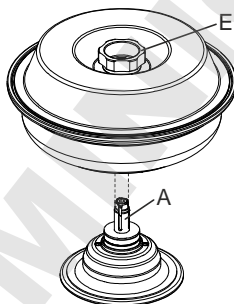

Einsetzen des Rotors:



Schmutzpartikel zwischen der Nabe und dem Rotor verhindern einen einwandfreien Sitz des Rotors und verursachen einen unruhigen Lauf. Bei Bedarf vor dem Einsetzen des Rotors die Nabe (A) auf der Motorwelle und die Nabe des Rotors reinigen.

- Den Rotor am Drehgriff (E) des Deckels anheben, waagrecht auf die Nabe (A) aufsetzen und bis zum Anschlag nach unten drücken.

Herausnehmen des Rotors:

- Den Rotor am Drehgriff (E) des Deckels festhalten und von der Nabe (A) abheben.

12 Gehänge in den Rotor einsetzen und herausnehmen

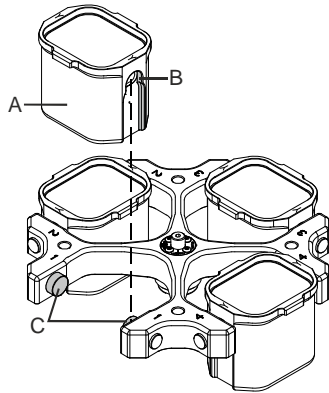

Bei Ausschwingrotoren müssen alle Plätze des Rotors mit **gleichen** Gehängen besetzt sein.



Bestimmte Gehänge sind mit der Nummer des Rotorplatzes gekennzeichnet. Diese Gehänge dürfen nur in den entsprechenden Platz des Rotors eingesetzt werden.

Gehänge die mit einer Set-Nummer gekennzeichnet sind, z. B. S001/4, dürfen nur im Set verwendet werden.

Gehänge in den Rotor einsetzen:

- Den Rotor auf festen Sitz prüfen.
- Die Tragzapfen (C) einfetten (Hettich-Schmierfett Nr 4051).
- Die Gehänge (A) in den Rotor einsetzen. Dabei beachten, dass sich die Tragzapfen (C) in der Nuten (B) der Gehänge befinden.
- Die Gehänge bis zum Anschlag nach unten schieben.

Gehänge aus dem Rotor herausnehmen:

- Die Gehänge (A) senkrecht nach oben aus dem Rotor herausziehen.

13 Adapter in die Gehänge einsetzen und herausnehmen

Adapter in die Gehänge einsetzen:

- Die Adapter (A) waagrecht in die Gehänge (B) einsetzen.

Adapter aus den Gehängen herausnehmen:

- Die Adapter (A) nach oben aus den Gehängen (B) herausnehmen.

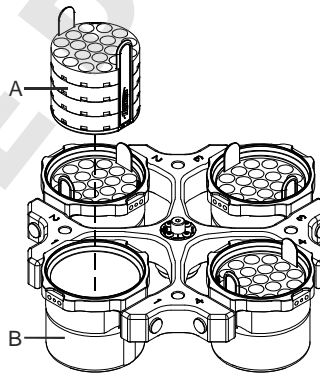
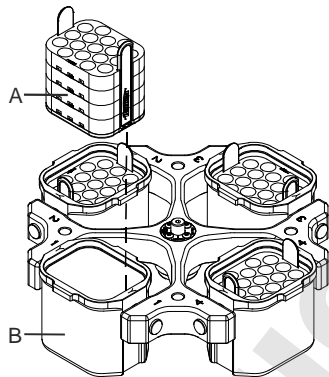

14 Adapter mit Positionierungszapfen in Gehänge einsetzen

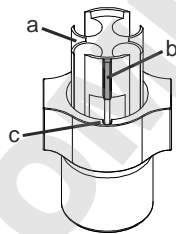

- Den Adapter (a) so in das Gehänge einsetzen, dass sich der Positionierungszapfen (b) in der Nut (c) des Gehänges befindet.



Wird der Adapter (a) nicht korrekt eingesetzt, können die Zentrifugiergefäße während des Zentrifugationslaufes beschädigt werden.

15 Beladen des Rotors



Standard-ZentrifugiergefäÙe aus Glas sind belastbar bis RZB 4000 (DIN 58970 Teil 2).

- Den Rotor auf festen Sitz prüfen.
- Bei Ausschwingrotoren müssen alle Plätze des Rotors mit **gleichen** Gehängen besetzt sein. Bestimmte Gehänge sind mit der Nummer des Rotorplatzes gekennzeichnet. Diese Gehänge dürfen nur in den entsprechenden Platz des Rotors eingesetzt werden. Gehänge die mit einer Set-Nummer gekennzeichnet sind, z. B. S001/4, dürfen nur im Set verwendet werden.
- Die Rotoren und Gehänge dürfen nur symmetrisch beladen werden. Die ZentrifugiergefäÙe müssen gleichmäÙig auf alle Plätze des Rotors verteilt werden. Zugelassene Kombinationen siehe Kapitel "Anhang/Appendix, Rotoren und Zubehör/Rotors and accessories". Bei Winkelrotoren müssen alle möglichen Plätze des Rotors beladen werden, siehe Kapitel "Anhang/Appendix, Rotoren und Zubehör/Rotors and accessories".

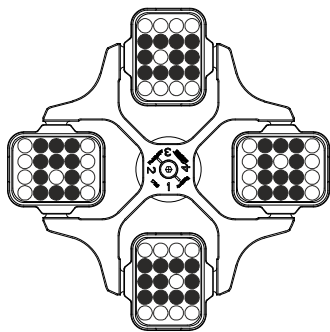

Rotor ist symmetrisch beladen

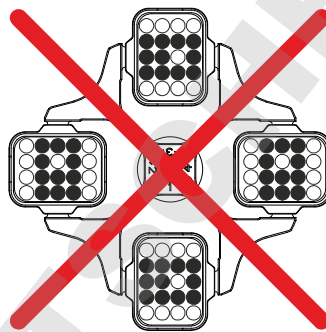

Nicht zulässig!
Rotor ist unsymmetrisch beladen

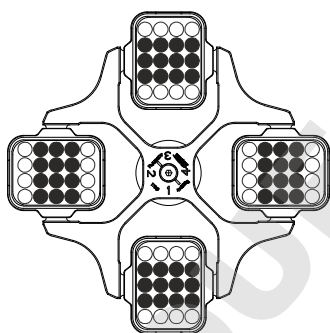

Rotor ist gleichmäÙig beladen

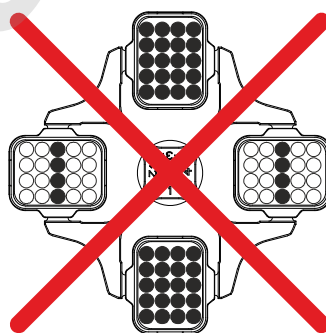

Nicht zulässig!
Rotor ist ungleichmäÙig beladen

- Auf bestimmten Gehängen ist das Gewicht der maximalen Beladung oder das Gewicht der maximalen Beladung und das maximale Gewicht des komplett bestückten Gehänges angegeben. Diese Gewichte dürfen nicht überschritten werden. Im Ausnahmefall siehe Kapitel "Zentrifugation von Stoffen oder Stoffgemischen mit einer höheren Dichte als $1,2 \text{ kg/dm}^3$ ". Die Gewichtsangabe der maximalen Beladung umfasst das Gesamtgewicht von Adapter, ZentrifugiergefäÙ und Inhalt.
- Bei Behältern mit Gummieinlagen muss sich unter den ZentrifugiergefäÙen immer die gleiche Anzahl von Gummieinlagen befinden.
- Die ZentrifugiergefäÙe dürfen nur außerhalb der Zentrifuge befüllt werden.

- Die vom Hersteller angegebene maximale Füllmenge der Zentrifugiergefäße darf nicht überschritten werden.

Bei Winkelrotoren dürfen die Zentrifugiergefäße nur soweit befüllt werden, dass während des Zentrifugationslaufes keine Flüssigkeit aus den Gefäßen herausgeschleudert werden kann.

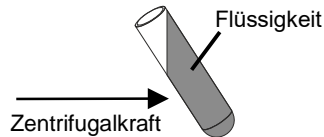

- Beim Beladen der Winkelrotoren darf keine Flüssigkeit in die Winkelrotoren und in den Schleuderraum gelangen.
- Beim Beladen der Gehänge der Ausschwingrotoren und beim Ausschwingen der Gehänge während des Zentrifugationslaufes darf keine Flüssigkeit in die Gehänge und in den Schleuderraum gelangen.
- Um die Gewichtsunterschiede innerhalb der Zentrifugiergefäße möglichst gering zu halten, ist auf eine gleichmäßige Füllhöhe in den Gefäßen zu achten.

16 Verschließen von Bio-Sicherheitssystemen



Um Dichtigkeit zu gewährleisten, muss der Deckel eines Bio-Sicherheitssystems fest verschlossen werden.

Um ein Verdrehen des Dichtungsringes während dem Öffnen und Schließen des Deckels zu vermeiden, muss der Dichtungsring mit einem Gummi-Pflegemittel leicht eingerieben werden.

Wird das Gehänge eines Bio-Sicherheitssystems ohne den Deckel verwendet, muss der Dichtring vom Gehänge entfernt werden, um eine Beschädigung des Dichtrings während des Zentrifugationslaufes zu vermeiden. Beschädigte Dichtringe dürfen nicht mehr zum Abdichten des Bio-Sicherheitssystems verwendet werden.

Lieferbare Bio-Sicherheitssysteme siehe Kapitel "Anhang/Appendix, Rotoren und Zubehör/Rotors and accessories". Im Zweifelsfall sind entsprechende Informationen beim Hersteller einzuholen.

Deckel mit Schraubverschluss

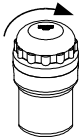

- Den Deckel auf das Gehänge aufsetzen.
- Den Deckel von Hand, durch Drehen im Uhrzeigersinn, fest verschließen.

17 Bedien- und Anzeigeelemente

Siehe Abbildung auf Seite 2.

Fig. 2: Anzeige- und Bedienfeld

17.1 Symbole des Bedienfeldes



Rotationsanzeige. Die Rotationsanzeige leuchtet rotierend gegen den Uhrzeigersinn auf, solange sich der Rotor dreht.

Bei Stillstand des Rotors wird in der Rotationsanzeige durch Symbole der Zustand des Deckels angezeigt:

Symbol : Deckel geöffnet

Symbol : Deckel geschlossen

Bedienfehler und auftretende Störungen werden im Display angezeigt (siehe Kapitel "Störungen").

17.2 Tasten und Einstellmöglichkeiten

RPM/RCF x 100



• Drehzahl

Einstellbar ist ein Zahlenwert von 500 RPM bis zur maximalen Drehzahl des Rotors. Maximale Drehzahl des Rotors siehe Kapitel "Anhang/Appendix, Rotoren und Zubehör/Rotors and accessories". Einstellbar in 100er Schritten (RPM = angezeigter Wert x 100).

Bei Gedrückthalten der Taste oder ändert sich der Wert mit zunehmender Geschwindigkeit.

• Die Bremsstufe und den Zentrifugerradius anzeigen.

t



• Laufzeit

- Einstellbar von 1 - 99 Minuten, in 1 Minuten-Schritten

- Dauerlauf "--"

• Zentrifugerradius. Eingabe in Zentimeter. Einstellbar von 5 - 16 Zentimeter, in 1 Zentimeter-Schritten. Zentrifugerradius siehe Kapitel "Anhang/Appendix, Rotoren und Zubehör/Rotors and accessories".

• Bremsstufen 0 oder 1. Stufe 1 = kurze Auslaufzeit, Stufe 0 = lange Auslaufzeit.

Bei Gedrückthalten der Taste oder ändert sich der Wert mit zunehmender Geschwindigkeit.



• Zentrifugationslauf starten.



• Zentrifugationslauf beenden.

Der Rotor läuft mit vorgewählter Bremsstufe aus.

• Die Bremsstufe und den Zentrifugerradius speichern.



• Anzeige der relativen Zentrifugalbeschleunigung (RCF).

Die Anzeige der relativen Zentrifugalbeschleunigung (RCF) erfolgt, solange die Taste gedrückt gehalten wird.



• Kurzzeitzentrifugation.

Der Zentrifugationslauf erfolgt, solange die Taste gedrückt gehalten wird.

• Die Bremsstufe und den Zentrifugerradius anzeigen.

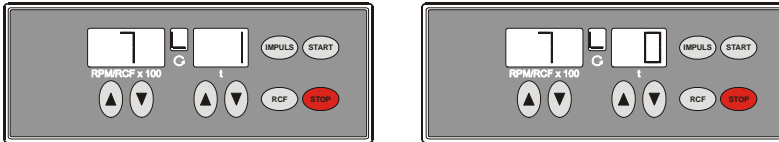

18 Bremsstufe einstellen

- Den Netzschalter ausschalten.
- Die Taste  unterhalb der Drehzahl-Anzeige und die Taste **(IMPULS)** gleichzeitig gedrückt halten.
- Den Netzschalter einschalten und die Tasten wieder loslassen.
In der Drehzahl-Anzeige wird die Maschinenversion und in der Zeit-Anzeige die eingestellte Bremsstufe angezeigt: z.B.:



Werden die Maschinenversion und die Bremsstufe nicht angezeigt, dann die Taste  unterhalb der Drehzahl-Anzeige so oft drücken, bis diese angezeigt werden.



Die Maschinenversion ist werksseitig eingestellt und kann nicht verändert werden.

- Mit den Tasten   unterhalb der Zeit-Anzeige die gewünschte Bremsstufe einstellen.
Stufe 1 = kurze Auslaufzeit, Stufe 0 = lange Auslaufzeit.
Auslaufzeiten siehe Kapitel "Anhang/Appendix, Rotoren und Zubehör/Rotors and accessories".
- Die Taste **(STOP)** drücken um die Einstellung zu speichern.

19 Zentrifugerradius einstellen



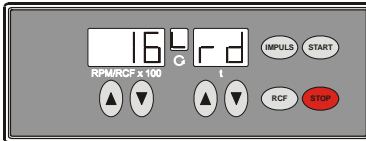

Der Zentrifugerradius muss in Zentimeter eingegeben werden.

- Den Netzschalter ausschalten.
- Die Taste  unterhalb der Drehzahl-Anzeige und die Taste **(IMPULS)** gleichzeitig gedrückt halten.
- Den Netzschalter einschalten und die Tasten wieder loslassen.
- Die Taste  unterhalb der Drehzahl-Anzeige so oft drücken, bis folgende Anzeige erscheint:



In der Drehzahl-Anzeige wird der eingestellte Zentrifugerradius angezeigt.

- Mit den Tasten   unterhalb der Zeit-Anzeige den gewünschten Zentrifugerradius einstellen.
Zentrifugerradius siehe Kapitel "Anhang/Appendix, Rotoren und Zubehör/Rotors and accessories".
- Die Taste **(STOP)** drücken um die Einstellung zu speichern.

20 Zentrifugation





Während eines Zentrifugationslaufes dürfen sich gemäß EN / IEC 61010-2-020, in einem Sicherheitsbereich von 300 mm um die Zentrifuge herum, keine Personen, Gefahrstoffe und Gegenstände befinden.



Wird der zulässige Gewichtsunterschied innerhalb der Beladung des Rotors überschritten, schaltet der Antrieb während des Anlaufs ab, und Fehler **-3-** wird angezeigt (siehe Kapitel "Störungen").

Ein Zentrifugationslauf kann jederzeit durch Drücken der Taste **(STOP)** abgebrochen werden.

Die Zeit und die Drehzahl können während des Zentrifugationslaufes, mit den Tasten  , geändert werden.

Bei Gedrückthalten der Taste  oder  ändert sich der Wert mit zunehmender Geschwindigkeit.





Nach einem Zentrifugationslauf blinkt die Anzeige bis der Deckel geöffnet, oder eine Taste gedrückt wird.

Blinkt in der Rotationsanzeige  abwechselnd das Symbol **"_"** (Deckel geschlossen) und **"L"** (Deckel geöffnet), so ist eine weitere Bedienung der Zentrifuge erst nach einmaligem Öffnen des Deckels möglich.

Wird **rot xx** angezeigt, so hat kein Zentrifugationslauf stattgefunden, weil zuvor der Rotor gewechselt wurde, siehe Kapitel "Rotor-Erkennung".

- Den Netzschalter einschalten (Schalterstellung "1").
- Den Rotor beladen und den Zentrifugendeckel schließen.

20.1 Zentrifugation mit Zeitvorwahl

- Mit den Tasten   unterhalb der Drehzahl-Anzeige die gewünschte Drehzahl einstellen.
- Mit den Tasten   unterhalb der Zeit-Anzeige die gewünschte Zeit einstellen.
- Die Taste **[START]** drücken. Die Rotationsanzeige  erfolgt solange sich der Rotor dreht.







Die Zeit wird in Minuten angezeigt. Die letzte Minute wird in Sekunden heruntergezählt.
Wird die Zeit in Minuten angezeigt, blinkt neben der Zahl ein Punkt.

- Nach Ablauf der Zeit oder bei Abbruch des Zentrifugationslaufes durch Drücken der Taste **[STOP]**, erfolgt der Auslauf des Rotors mit der eingestellten Bremsstufe.

Während des Zentrifugationslaufes werden die Drehzahl des Rotors oder der daraus resultierende RCF-Wert, und die verbleibende Zeit angezeigt.

20.2 Dauerlauf

- Mit den Tasten   unterhalb der Drehzahl-Anzeige die gewünschte Drehzahl einstellen.
- Mit der Taste  unterhalb der Zeit-Anzeige die Zeit auf Null stellen. Es wird "--" wird angezeigt.
- Die Taste **[START]** drücken. Die Rotationsanzeige  erfolgt solange sich der Rotor dreht. Die Zeitählung beginnt bei 0.





Die erste Minute wird in Sekunden hochgezählt, danach wird die Zeit in Minuten angezeigt.
Wird die Zeit in Minuten angezeigt, blinkt neben der Zahl ein Punkt.

- Die Taste **[STOP]** drücken um den Zentrifugationslauf zu beenden. Der Auslauf des Rotors erfolgt mit der eingestellten Bremsstufe.

Während des Zentrifugationslaufes werden die Drehzahl des Rotors oder der daraus resultierende RCF-Wert, und die gelaufene Zeit angezeigt.

20.3 Kurzzeitzentrifugation

- Mit den Tasten   unterhalb der Drehzahl-Anzeige die gewünschte Drehzahl einstellen.
- Die Taste **[IMPULS]** gedrückt halten. Die Rotationsanzeige  erfolgt solange sich der Rotor dreht. Die Zeitählung beginnt bei 0.



Die erste Minute wird in Sekunden hochgezählt, danach wird die Zeit in Minuten angezeigt.
Wird die Zeit in Minuten angezeigt, blinkt neben der Zahl ein Punkt.

- Die Taste **[IMPULS]** wieder loslassen um den Zentrifugationslauf zu beenden. Der Auslauf des Rotors erfolgt mit der eingestellten Bremsstufe.

Während des Zentrifugationslaufes werden die Drehzahl des Rotors und die gelaufene Zeit angezeigt.

20.4 Anzeige der relativen Zentrifugalbeschleunigung (RCF)

Während des Zentrifugationslaufes kann die relative Zentrifugalbeschleunigung (RCF) angezeigt werden.



Wird mit der relativen Zentrifugalbeschleunigung (RCF) gearbeitet, ist die Eingabe des Zentrifugerradius notwendig.

- Während des Zentrifugationslaufes die Taste **[RCF]** gedrückt halten.
Die relative Zentrifugalbeschleunigung (RCF) erscheint in der Drehzahl-Anzeige (RCF = angezeigter Wert x 100).
- Die Taste **[RCF]** wieder loslassen. Es wird wieder die Drehzahl angezeigt.



21 Akustisches Signal

Das akustische Signal ertönt:

- nach Auftreten einer Störung im 2 s-Intervall.
- nach Beendigung des Zentrifugationslaufes und Stillstand des Rotors im 30 s-Intervall.

Durch Öffnen des Deckels oder Drücken einer beliebigen Taste wird das akustische Signal beendet.

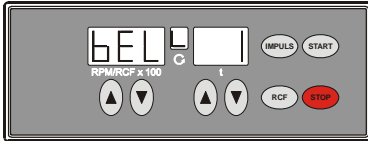

Das akustische Signal kann, bei Stillstand des Rotors, folgendermaßen aktiviert oder deaktiviert werden:

- Den Netzschalter ausschalten.
- Die Taste  unterhalb der Drehzahl-Anzeige und die Taste **IMPULS** gleichzeitig gedrückt halten.
- Den Netzschalter einschalten und die Tasten wieder loslassen.
- Die Taste  unterhalb der Drehzahl-Anzeige so oft drücken, bis folgende Anzeige erscheint:



In der Zeit-Anzeige wird die Einstellung des akustischen Signals angezeigt.

0 = Akustisches Signal deaktiviert, 1 = Akustisches Signal aktiviert.

- Mit den Tasten   unterhalb der Zeit-Anzeige 0 oder 1 einstellen.
- Die Taste **STOP** drücken um die Einstellung zu speichern.

22 Relative Zentrifugalbeschleunigung (RCF)

Die relative Zentrifugalbeschleunigung (RCF) wird als Vielfaches der Erdbeschleunigung (g) angegeben. Sie ist ein einheitsfreier Zahlenwert und dient zum Vergleich der Trenn- und Sedimentationsleistung.

Die Berechnung erfolgt nach der Formel:

$$\text{RCF} = \left(\frac{\text{RPM}}{1000} \right)^2 \times r \times 1,118 \quad \Rightarrow \quad \text{RPM} = \sqrt{\frac{\text{RCF}}{r \times 1,118}} \times 1000$$

RCF = Relative Zentrifugalbeschleunigung

RPM = Drehzahl

r = Zentrifugerradius in mm = Abstand von der Mitte der Drehachse bis zum Zentrifugiergefäßboden.
Zentrifugerradius siehe Kapitel "Anhang/Appendix, Rotoren und Zubehör/
Rotors and accessories".



Die relative Zentrifugalbeschleunigung (RCF) ist von der Drehzahl und dem Zentrifugerradius abhängig.

23 Zentrifugation von Stoffen oder Stoffgemischen mit einer höheren Dichte als 1,2 kg/dm³

Bei der Zentrifugation mit maximaler Drehzahl darf die Dichte der Stoffe oder Stoffgemische 1,2 kg/dm³ nicht überschreiten.

Bei Stoffen oder Stoffgemischen mit einer höheren Dichte muss die Drehzahl reduziert werden.

Die erlaubte Drehzahl lässt sich nach folgender Formel berechnen:

$$\text{Reduzierte Drehzahl (n}_{\text{red}}) = \sqrt{\frac{1,2}{\text{höhere Dichte [kg/dm}^3]}} \times \text{maximale Drehzahl [RPM]}$$

z.B.: Maximale Drehzahl 4000 RPM, Dichte 1,6 kg/dm³

$$n_{\text{red}} = \sqrt{\frac{1,2 \text{ kg/dm}^3}{1,6 \text{ kg/dm}^3}} \times 4000 \text{ RPM} = 3464 \text{ RPM}$$

Wird im Ausnahmefall die, auf dem Gehänge angegebene, maximale Beladung überschritten, muss die Drehzahl ebenfalls reduziert werden.

Die erlaubte Drehzahl lässt sich nach folgender Formel berechnen:

$$\text{Reduzierte Drehzahl (n}_{\text{red}}) = \sqrt{\frac{\text{maximale Beladung [g]}}{\text{tatsächliche Beladung [g]}}} \times \text{maximale Drehzahl [RPM]}$$

z.B.: Maximale Drehzahl 4000 RPM, maximale Beladung 300 g, tatsächliche Beladung 350 g

$$n_{\text{red}} = \sqrt{\frac{300 \text{ g}}{350 \text{ g}}} \times 4000 \text{ RPM} = 3703 \text{ RPM}$$

Bei eventuellen Unklarheiten ist Auskunft beim Hersteller einzuholen.

24 Rotorerkennung

Nach Start eines jeden Zentrifugationslaufes wird eine Rotorerkennung durchgeführt.

Wurde der Rotor gewechselt, wird der Zentrifugationslauf nach der Rotorerkennung abgebrochen. Der Rotorcode (rot xx) des Rotors wird angezeigt.

- Die Taste **START** drücken. Die zuletzt benutzten Zentrifugierdaten werden angezeigt.



Eine weitere Bedienung der Zentrifuge ist erst nach einmaligem Öffnen des Deckels möglich.

Wenn die maximale Drehzahl des verwendeten Rotors kleiner als die eingestellte Drehzahl ist, wird die Drehzahl auf die maximale Drehzahl des Rotors begrenzt.

25 Notentriegelung

Bei einem Stromausfall kann der Deckel nicht geöffnet werden. Es muss eine Notentriegelung von Hand durchgeführt werden.



Zur Notentriegelung die Zentrifuge vom Netz trennen.

Den Deckel nur bei Stillstand des Rotors öffnen.

Zur Notentriegelung darf nur der mitgelieferte Entriegelungsstift aus Kunststoff verwendet werden.

Siehe Abbildung auf Seite 2.

- Den Netzschalter ausschalten (Schalterstellung "0").
- Durch das Fenster im Deckel schauen, um sich zu vergewissern, dass der Rotor stillsteht.
- Den Entriegelungsstift waagrecht in die Bohrung (Fig. 1, A) einführen. Den Entriegelungsstift so weit hineinschieben, bis sich beim nach unten Drücken des Stiftes die Griffleiste nach oben schwenken lässt.
- Den Deckel öffnen.

26 Pflege und Wartung



Das Gerät kann kontaminiert sein.



Vor der Reinigung den Netzstecker ziehen.

Bevor ein anderes als das vom Hersteller empfohlene Reinigungs- oder Dekontaminationsverfahren angewandt wird, hat sich der Benutzer beim Hersteller zu vergewissern, dass das vorgesehene Verfahren das Gerät nicht schädigt.

- Zentrifugen, Rotoren und das Zubehör dürfen nicht in Spülmaschinen gereinigt werden.
- Es darf nur eine Handreinigung und eine Flüssig-Desinfektion durchgeführt werden.
- Die Wassertemperatur muss 20 – 25°C betragen.
- Es dürfen nur Reinigungs- oder Desinfektionsmittel verwendet werden, die:
 - im pH-Bereich 5 - 8 liegen,
 - keine Ätzalkalien, Peroxide, Chlorverbindungen, Säuren und Laugen enthalten.
- Um Korrosionserscheinungen durch Reinigungs- oder Desinfektionsmittel zu vermeiden sind die speziellen Anwendungshinweise vom Hersteller des Reinigungs- oder Desinfektionsmittels unbedingt zu beachten.

26.1 Zentrifuge (Gehäuse, Deckel und Schleuderraum)

26.1.1 Oberflächenreinigung und -pflege

- Das Gehäuse der Zentrifuge und den Schleuderraum regelmäßig säubern und bei Bedarf mit Seife oder einem milden Reinigungsmittel und einem feuchten Tuch reinigen. Dies dient zum einen der Hygiene und es verhindert Korrosion durch anhaftende Verunreinigungen.
- Inhaltsstoffe geeigneter Reinigungsmittel:
Seife, anionische Tenside, nichtionische Tenside.
- Nach dem Einsatz von Reinigungsmitteln, die Reste des Reinigungsmittels, durch Nachwischen mit einem feuchten Tuch, entfernen.
- Die Flächen müssen unmittelbar nach der Reinigung getrocknet werden.
- Bei Bildung von Kondenswasser den Schleuderraum, durch Auswischen mit einem saugfähigen Tuch, trocknen.
- Die Gummidichtung des Schleuderraums nach jeder Reinigung mit einem Gummi-Pflegemittel leicht einreiben.
- Der Schleuderraum ist jährlich auf Schäden zu überprüfen.



Werden sicherheitsrelevante Schäden festgestellt, darf die Zentrifuge nicht mehr in Betrieb genommen werden. In diesem Fall ist der Kundendienst zu benachrichtigen.

26.1.2 Oberflächendesinfektion

- Gelangt infektiöses Material in den Schleuderraum, so ist dieser umgehend zu desinfizieren.
- Inhaltsstoffe geeigneter Desinfektionsmittel:
Äthanol, n-Propanol, Ethylhexanol, anionische Tenside, Korrosionsinhibitoren.
- Nach dem Einsatz von Desinfektionsmitteln, die Reste des Desinfektionsmittels, durch Nachwischen mit einem feuchten Tuch, entfernen.
- Die Flächen müssen unmittelbar nach der Desinfektion getrocknet werden.

26.1.3 Entfernen radioaktiver Verunreinigungen

- Das Mittel muss speziell für das Entfernen radioaktiver Verunreinigungen ausgewiesen sein.
- Inhaltsstoffe geeigneter Mittel für das Entfernen radioaktiver Verunreinigungen:
Anionische Tenside, nichtionische Tenside, polyhydrierter Äthanol.
- Nach dem Entfernen der radioaktiven Verunreinigungen, die Reste des Mittels, durch Nachwischen mit einem feuchten Tuch, entfernen.
- Die Flächen müssen unmittelbar nach dem Entfernen der radioaktiven Verunreinigungen getrocknet werden.

26.2 Rotoren und Zubehör

26.2.1 Reinigung und Pflege

- Um einer Korrosion und Materialveränderungen vorzubeugen müssen die Rotoren und das Zubehör regelmäßig mit Seife oder einem milden Reinigungsmittel und einem feuchten Tuch gereinigt werden. Die Reinigung wird mindestens einmal wöchentlich empfohlen. Verschmutzungen müssen sofort entfernt werden.
- Inhaltsstoffe geeigneter Reinigungsmittel:
Seife, anionische Tenside, nichtionische Tenside.
- Nach dem Einsatz von Reinigungsmitteln, die Reste des Reinigungsmittels, durch Nachspülen mit Wasser (nur außerhalb der Zentrifuge) oder Nachwischen mit einem feuchten Tuch, entfernen.
- Die Rotoren und das Zubehör müssen unmittelbar nach der Reinigung getrocknet werden.
- Winkelrotoren, Behälter und Gehänge aus Aluminium sind nach dem Trocknen mit säurefreiem Fett z.B. Vaseline leicht einzufetten.
- Bei Bio-Sicherheitssystemen sind die Dichtungsringe wöchentlich zu reinigen.
Die Dichtungsringe sind aus Silikon hergestellt. Um die Dichtigkeit der Bio-Sicherheitssysteme zu gewährleisten, dürfen die Dichtungsringe nach der Reinigung oder nach dem Autoklavieren nicht mit Talkum-Puder behandelt werden.
Vor jedem Gebrauch des Bio-Sicherheitssystems müssen alle Teile des Bio-Sicherheitssystems visuell auf Beschädigung überprüft werden. Außerdem muss die korrekte Einbaulage des Dichtungsringes bzw. der Dichtungsringe des Bio-Sicherheitssystems überprüft werden.
Die beschädigten Teile des Bio-Sicherheitssystems müssen sofort ausgetauscht werden.
Bei Anzeichen von Rissbildung, Versprödung oder Abnutzung ist der betreffende Dichtungsring sofort auszutauschen. Bei Deckeln mit nicht auswechselbaren Dichtungsringen muss der gesamte Deckel ausgetauscht werden.
Lieferbare Bio-Sicherheitssysteme siehe Kapitel "Anhang/Appendix, Rotoren und Zubehör/Rotors and accessories".
- Um Korrosion infolge Feuchtigkeit zwischen Rotor und Motorwelle zu verhindern, sollte der Rotor mindestens einmal im Monat ausgebaut, gereinigt und die Motorwelle leicht gefettet werden.
- Die Rotoren und das Zubehör sind wöchentlich auf Verschleiß und Korrosionsschäden zu überprüfen.
Bei Ausschwingrotoren muss vor allem der Bereich der Tragzapfen und bei Gehängen die Nuten und der Boden auf Risse geprüft werden.
Beispiel: Riss im Bereich der Nut:



 Rotoren und Zubehör dürfen bei Anzeichen von Verschleiß oder Korrosion nicht mehr verwendet werden.

- Den Rotor wöchentlich auf festen Sitz prüfen.

26.2.2 Desinfektion

- Gelangt infektiöses Material auf die Rotoren oder auf das Zubehör, so muss eine geeignete Desinfektion durchgeführt werden.
- Inhaltsstoffe geeigneter Desinfektionsmittel:
Äthanol, n-Propanol, Ethylhexanol, anionische Tenside, Korrosionsinhibitoren.
- Nach dem Einsatz von Desinfektionsmitteln, die Reste des Desinfektionsmittels, durch Nachspülen mit Wasser (nur außerhalb der Zentrifuge) oder Nachwischen mit einem feuchten Tuch, entfernen.
- Die Rotoren und das Zubehör müssen unmittelbar nach der Desinfektion getrocknet werden.

26.2.3 Entfernen radioaktiver Verunreinigungen

- Das Mittel muss speziell für das Entfernen radioaktiver Verunreinigungen ausgewiesen sein.
- Inhaltsstoffe geeigneter Mittel für das Entfernen radioaktiver Verunreinigungen: Anionische Tenside, nichtionische Tenside, polyhydrierter Äthanol.
- Nach dem Entfernen der radioaktiven Verunreinigungen, die Reste des Mittels, durch Nachspülen mit Wasser (nur außerhalb der Zentrifuge) oder Nachwischen mit einem feuchten Tuch, entfernen.
- Die Rotoren und das Zubehör müssen unmittelbar nach dem Entfernen der radioaktiven Verunreinigungen getrocknet werden.

26.2.4 Tragzapfen

Bei Ausschwingrotoren müssen die Tragzapfen regelmäßig gefettet werden (Hettich-Schmierfett Nr. 4051), um ein gleichmäßiges Ausschwingen der Gehänge zu gewährleisten.

26.2.5 Rotoren und Zubehör mit begrenzter Verwendungsdauer

Die Verwendung von bestimmten Rotoren, Gehängen und Zubehörteilen ist zeitlich begrenzt.

Diese sind mit der maximal erlaubten Anzahl der Laufzyklen oder dem Ablaufdatum und der maximalen Anzahl der Laufzyklen oder nur mit dem Ablaufdatum gekennzeichnet, z.B.:

- "einsetzbar bis Ende: IV. Quartal 2011 / usable until end of: IV. Quartal 2011" oder "einsetzbar bis Ende Monat/Jahr: 10/2011 / usable until end of month/year: 10/2011"
- "max. Laufzyklen / max. cycles: 40000".



Aus Sicherheitsgründen dürfen die Rotoren, Gehänge und Zubehörteile nicht mehr verwendet werden, wenn entweder die darauf gekennzeichnete maximal erlaubte Anzahl der Laufzyklen oder das darauf gekennzeichnete Ablaufdatum erreicht ist.

26.3 Autoklavieren

Das folgende Zubehör darf bei 121°C / 250°F (20 min) autoklaviert werden:

- Ausschwingrotoren
- Winkelrotoren aus Aluminium
- Gehänge aus Metall
- Deckel mit Bioabdichtung
- Adapter

Über den Sterilitätsgrad kann keine Aussage gemacht werden.



Die Deckel der Rotoren und Behälter müssen vor dem Autoklavieren abgenommen werden.

Das Autoklavieren beschleunigt den Alterungsprozess von Kunststoffen. Außerdem kann es bei Kunststoffen Farbveränderungen verursachen.

Nach dem Autoklavieren sind die Rotoren und das Zubehör visuell auf Beschädigung zu überprüfen und eventuell beschädigte Teile sofort auszutauschen.

Bei Anzeichen von Rissbildung, Versprödung oder Abnutzung ist der betreffende Dichtungsring sofort auszutauschen.

Bei Deckeln mit nicht auswechselbaren Dichtungsringen muss der gesamte Deckel ausgetauscht werden.

Um die Dichtigkeit der Bio-Sicherheitssysteme zu gewährleisten, dürfen die Dichtungsringe nach dem Autoklavieren nicht mit Talkum-Puder behandelt werden.

26.4 Zentrifugiergefäße

- Bei Undichtigkeit oder nach dem Bruch von Zentrifugiergefäßen, sind zerbrochene Gefäßteile, Glassplitter und ausgelaufenes Zentrifugiergut vollständig zu entfernen.
- Die Gummieinlagen sowie die Kunststoff-Hülsen der Rotoren sind nach einem Glasbruch zu ersetzen.



Verbleibende Glassplitter verursachen weiteren Glasbruch !

- Handelt es sich um infektiöses Material so ist umgehend eine Desinfektion durchzuführen.

27 Störungen

Lässt sich der Fehler laut Störungstabelle nicht beheben, so ist der Kundendienst zu benachrichtigen.

Bitte den Zentrifugentyp und die Seriennummer angeben. Beide Nummern sind auf dem Typenschild der Zentrifuge ersichtlich.

	<p>Einen NETZ-RESET durchführen:</p> <ul style="list-style-type: none"> - Den Netzschalter ausschalten (Schalterstellung "0"). - Mindestens 10 Sekunden lang warten und anschließend den Netzschalter wieder einschalten (Schalterstellung "I").
---	--

Störung	Anzeige	Fehlerursache	Beseitigung
keine Anzeige	---	Keine Spannung. Netzeingangssicherungen defekt.	<ul style="list-style-type: none"> - Versorgungsspannung überprüfen. - Netzeingangssicherungen überprüfen, siehe Kapitel "Netzgangssicherungen wechseln". - Netzschalter EIN.
Tachofehler	- 1 -	Ausfall der Drehzahlimpulse.	<ul style="list-style-type: none"> - Das Gerät darf nicht ausgeschaltet werden, solange die Rotationsanzeige  rotierend aufleuchtet. Warten bis in der Rotationsanzeige das Symbol "—" (Deckel geschlossen) angezeigt wird (nach ca. 100 Sekunden) und anschließend einen "NETZ-RESET" durchführen.
NETZ-RESET	- 2 -	Netzunterbrechung während des Zentrifugationslaufes. (Der Zentrifugationslauf wurde nicht beendet.)	<ul style="list-style-type: none"> - Nach Stillstand Deckel öffnen und Taste  betätigen. - Bei Bedarf den Zentrifugationslauf wiederholen.
Unwucht	- 3 -	Der Rotor ist ungleichmäßig beladen.	<ul style="list-style-type: none"> - Deckel nach Rotor-Stillstand öffnen. - Die Beladung des Rotors überprüfen, siehe Kapitel "Beladen des Rotors". - Den Zentrifugationslauf wiederholen.
Kommunikation	- 4 -	Fehler im Steuerteil oder Leistungsteil.	<ul style="list-style-type: none"> - Nach Stillstand des Rotors einen NETZ-RESET durchführen.
Überlast	- 5 -	Motor oder Motoransteuerung defekt.	<ul style="list-style-type: none"> - Nach Stillstand des Rotors einen NETZ-RESET durchführen.
Überspannung Unterspannung	- 6 - - 8 -	Netzspannung außerhalb der Toleranzen (siehe Technische Daten).	<ul style="list-style-type: none"> - Nach Stillstand des Rotors einen NETZ-RESET durchführen. - Netzspannung kontrollieren.
Überdrehzahl	- 7 -	Fehler im Leistungsteil.	<ul style="list-style-type: none"> - Nach Stillstand des Rotors einen NETZ-RESET durchführen.
Übertemperatur	- 9 -	Übertemperaturschalter im Motor hat ausgelöst.	<ul style="list-style-type: none"> - Nach Rotor-Stillstand Deckel durch Notentriegelung öffnen (siehe Kapitel Notentriegelung). - Motor abkühlen lassen.
Version Error	In der Zeit-Anzeige wird eine Zahl angezeigt.	Falsche Maschinenversion eingestellt, Steuerteil springt in das Einstell-Menü.	<ul style="list-style-type: none"> - Mit den Tasten   unterhalb der Zeit-Anzeige die Zahl 4 einstellen. - Die Taste  drücken um die Einstellung zu speichern. - Einen NETZ-RESET durchführen.
Controller-Watchdog	- C -	Fehler im Steuerteil.	<ul style="list-style-type: none"> - Nach Stillstand des Rotors einen NETZ-RESET durchführen.
Deckelfehler	- d -	Fehler Deckelverriegelung.	<ul style="list-style-type: none"> - Nach Stillstand des Rotors einen NETZ-RESET durchführen.
Kurzschluss	- E -	Kurzschluss in Steuerteil / Leistungsteil.	<ul style="list-style-type: none"> - Nach Stillstand des Rotors einen NETZ-RESET durchführen.
Kein Rotorcode	- F -	Keine Rotorerkennung beim Start. Kein Rotor eingesetzt oder defekter Tacho.	<ul style="list-style-type: none"> - Nach Stillstand des Rotors einen NETZ-RESET durchführen.
Neuer Rotor erkannt	rot...	siehe Kapitel "Rotorerkennung".	<ul style="list-style-type: none"> - Die Taste  drücken.

28 Netzeingangssicherungen wechseln



Den Netzschalter ausschalten und das Gerät vom Netz trennen!

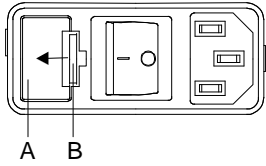

Der Sicherungshalter (A) mit den Netzeingangssicherungen befindet sich neben dem Netzschalter.

- Das Anschlusskabel aus dem Gerätestecker ziehen.
- Den Schnappverschluss (B) gegen den Sicherungshalter (A) drücken und diesen herausziehen.
- Defekte Netzeingangssicherungen austauschen.



Nur Sicherungen mit dem, für den Typ, festgelegten Nennwert verwenden, siehe nachfolgende Tabelle.

- Den Sicherungshalter wieder hineinschieben bis der Schnappverschluss einrastet.
- Das Gerät wieder ans Netz anschließen.

Modell	Typ	Sicherung	Best.-Nr.
ROTOFIX 32 A	1206, 1206-34	T 3,15 AH/250V	E997
ROTOFIX 32 A	1206-01, 1206-33	T 5 AH/250V	E914

29 Rücksendung von Geräten



Vor der Rücksendung des Gerätes muss die Transportsicherung eingebaut werden.

Wird das Gerät oder dessen Zubehör an die Firma Andreas Hettich GmbH & Co. KG zurückgesandt, so muss dieses, zum Schutz von Personen, Umwelt und Material, vor dem Versand dekontaminiert und gereinigt werden.

Eine Annahme von kontaminierten Geräten oder Zubehör behalten wir uns vor.

Anfallende Kosten für Reinigungs- und Desinfektionsmaßnahmen werden dem Kunden in Rechnung gestellt.

Wir bitten dafür um Ihr Verständnis.

30 Entsorgung

Vor der Entsorgung muss das Gerät, zum Schutz von Personen, Umwelt und Material, dekontaminiert und gereinigt werden.

Bei der Entsorgung des Geräts sind die jeweiligen gesetzlichen Vorschriften zu beachten.

Gemäß der Richtlinie 2002/96/EG (WEEE) dürfen alle nach dem 13.08.2005 gelieferten Geräte nicht mehr mit dem Hausmüll entsorgt werden. Das Gerät gehört zur Gruppe 8 (Medizinische Geräte) und ist in den Business-to-Business-Bereich eingeordnet.



Mit dem Symbol des durchgestrichenen Abfalleimers wird darauf hingewiesen, dass das Gerät nicht mit dem Hausmüll entsorgt werden darf.

Die Entsorgungsvorschriften der einzelnen EU-Länder können unterschiedlich sein. Im Bedarfsfall wenden Sie sich bitte an Ihren Lieferanten.

Contents

1	Use according to specification	33
2	Remaining risks	33
2	Technical specifications	33
3	Notes on safety	34
4	Symbol meanings	36
5	Delivery checklist	37
6	Unpacking the centrifuge	37
7	Transport and storage.....	37
7.1	Transport	37
7.2	Storage	37
8	Initial operation	38
9	Opening and closing the lid.....	38
9.1	Opening the lid	38
9.2	Closing the lid	38
10	Installation and removal of the rotor	39
10.1	Rotor with clamping nut.....	39
10.2	Rotor without clamping nut.....	39
10.2.1	Installing and removing the hub	39
10.2.2	Inserting and removing the rotor	39
11	Inserting and removing hangers into/from the rotor.....	40
12	Inserting and removing the adapters into/from the hangers	40
13	Inserting the adapter with positioning pin into the hanger	40
14	Loading the rotor	41
15	Closing biosafety systems.....	42
16	Control and display elements	43
16.1	Symbols on the control panel.....	43
16.2	Keys and setting options	43
17	Setting the brake step	44
18	Setting the centrifuging radius.....	44
19	Centrifugation	44
19.1	Centrifugation with preselected time	45
19.2	Continuous operation	45
19.3	Short-time centrifugation	45
19.4	Display of the relative centrifugal force (RCF).....	45
20	Acoustic signal	46
21	Relative centrifugal force (RCF)	46
22	Centrifugation of materials or mixtures of materials with a density higher than 1.2 kg/dm ³	47
23	Rotor recognition	47
24	Emergency release	47
25	Maintenance and servicing.....	48
25.1	Centrifuge (housing, lid and centrifuging chamber).....	48
25.1.1	Surface cleaning and care	48
25.1.2	Surface disinfection.....	48

25.1.3	Removal of radioactive contaminants	48
25.2	Rotors and Attachments	49
25.2.1	Cleaning and care.....	49
25.2.2	Disinfection	49
25.2.3	Removal of radioactive contaminants	49
25.2.4	Trunnions.....	50
25.2.5	Rotors and accessories with limited service lives	50
25.3	Autoclaving	50
25.4	Centrifuge containers.....	50
26	Faults	51
27	Change mains input fuses.....	52
28	Returning Devices	52
29	Disposal	52
31	Anhang / Appendix.....	97
31.1	Rotoren und Zubehör / Rotors and accessories.....	97

1 Use according to specification

This device is a medical product (laboratory centrifuge) within the context of the IVD Directive 98/79/EC.

The centrifuge was designed only for the separation of materials or mixtures with a density of no more than 1.2 kg/dm³. In particular, these include samples for preparation of in-vitro diagnostic purposes in human medicine.

The centrifuge is only meant for this purpose.

Another use or one which goes beyond this, is considered to be non-intended. The company Andreas Hettich GmbH & Co. KG is not liable for damage resulting from this.

Observing all information in the operating instructions and complying with the measures described therein is also a part of the intended use.

2 Remaining risks

The device is built according to the state-of-the-art and the recognized safety regulations. If used and handled improperly, there could be life-threatening danger to the user or third parties, or the device could be impaired or there could be other property damage. The device is only to be used for its intended purpose and only when it is in safe working condition.

Malfunctions which could affect safety must be corrected immediately.

2 Technical specifications

Manufacturer	Andreas Hettich GmbH & Co. KG D-78532 Tuttlingen	
Model	ROTOFIX 32 A	
Type	1206 1206-34	1206-01 1206-33
Mains voltage ($\pm 10\%$)	208 – 240 V 1~	100 – 127 V 1~
Mains frequency	50 – 60 Hz	50 – 60 Hz
Connected load	300 VA	300 VA
Current consumption	1.4 A	3.0 A
Max. capacity	4 x 100 ml / 32 x 15 ml	
Allowed density	1.2 kg/dm ³	
Speed (RPM)	6000	
Force (RCF)	4226	
Kinetic energy	3160 Nm	
Obligatory inspection (DGUV Regel 100 – 500)	no	
Ambient conditions (EN / IEC 61010-1)	Indoors only Up to 2000 m above sea level 2°C to 40°C Maximum relative humidity 80% for temperatures up to 31°C, linearly decreasing to 50% relative humidity at 40°C.	
– Set-up site		
– Altitude		
– Ambient temperature		
– Humidity		
– Excess-voltage category (IEC 60364-4-443)	II	
– Pollution degree	2	
Device protection class	I	
Not suitable for use in explosion-endangered areas.		
EMC		
– Emitted interference, Interference immunity	EN / IEC 61326-1, Class B	FCC Class B
Noise level (dependent on rotor)	≤ 57 dB(A)	
Dimensions		
– Width	366 mm	
– Depth	430 mm	
– Height	257 mm	
Weight	23 kg	

3 Notes on safety



No claim of warranty will be considered by the manufacturer unless ALL instructions in this manual have been followed.



- **The centrifuge should be installed on a good, stable base.**
- **Before using the centrifuge absolutely check the rotor for firm placement.**
- **When the centrifuge is running, according to EN / IEC 61010-2-020, no persons, dangerous substances or objects may be within the safety margin of 300 mm around the centrifuge.**
- **Rotors, suspensions and accessories that possess traces of corrosion or mechanical damage or if their term of use has expired may not be used any longer.**
- **The centrifuge may no longer be put into operation when the centrifuging chamber has safety-related damages.**
- **With swing-out rotors the trunnions must be regularly lubricated (Hettich Lubricating Grease No. 4051) in order to ensure consistent swinging out of the hangers.**
- **For centrifuges without temperature control, when the room temperature is increased and/or if the device is frequently used, the centrifuging chamber could be heated up. Therefore, it can't be ruled out that the sample material might be changed due to the temperature.**

- **Before the initial operation of your centrifuge you should read and pay attention to the operating instructions. Only personnel that has read and understood the operating instructions are allowed to operate the device.**
- Along with the operating instructions and the legal regulations on accident prevention, you should also follow the recognised professional regulations for working in a safe and professional manner. These operating instructions should be read in conjunction with any other instructions concerning accident prevention and environmental protection based on the national regulations of the country where the device is to be used.
- This centrifuge is a state-of-the-art piece of equipment which is extremely safe to operate. However, it can lead to danger for users or others if used by untrained staff, in an inappropriate way or for a purpose other than that it was designed for.
- The centrifuge must not be moved or knocked during operation.
- In case of fault or emergency release, never touch the rotor before it has stopped turning.
- To avoid damage due to condensate, when changing from a cold to a warm room the centrifuge must either heat up for at least 3 hours in the warm room before being connected to the mains, or run hot for 30 minutes in the cold room.
- Only the rotors and accessories approved by the manufacturer for this device may be used (see chapter "Anhang/Appendix, Rotoren und Zubehör/Rotors and accessories"). Before centrifuge vessels are used which are not listed in the chapter "Appendix, Rotors and accessories", the user must make sure they can be used by asking the manufacturer.
- The centrifuge rotor may only be loaded in accordance with the chapter "Loading the rotor".
- When centrifuging with maxim revolutions per minute the density of the materials or the material mixtures may not exceed 1.2 kg/dm³.
- The centrifuge may only be operated when the balance is within the bounds of acceptability.
- The centrifuge may not be operated in explosion-endangered areas.
- The centrifuge must not be used with:
 - inflammable or explosive materials
 - materials that react with one another producing a lot of energy.

- When centrifuging hazardous substances or mixtures, which are toxic, radioactive or contaminated with pathogenic microorganisms, suitable measures must be taken by the user.
Fundamentally, centrifuge containers with special screw closures must be used for hazardous substances. For materials of risk groups 3 and 4, in addition to sealable centrifuge containers, a bio-safety system must be used (see the "Laboratory Bio-safety Manual" from the World Health Organization).
In a bio-safety system, a bio-seal (sealing ring) prevents droplets and aerosols from escaping.
If the hanger of a bio-safety system is used without the lid, the sealing ring must be removed from the hanger to prevent damage to the sealing ring during the centrifugation run.
Damaged bio-safety systems are no longer microbiologically sealed.
If a bio-safety system is not used, a centrifuge is not microbiologically sealed for the purposes of the standard EN / IEC 61010-2-020.
When closing a bio-safety system, follow the instructions in the chapter "Closing biosafety systems".
For the available bio-safety systems, see the chapter "Appendix, Rotors and accessories". If in doubt, you can get the information you need from the manufacturer.
- The centrifuge must not be operated with highly corrosive substances which could impair the mechanical integrity of rotors, hangers and accessories.
- Repairs must only be carried out by personnel authorised to do so by the manufacturer.
- Only original spare parts and original accessories licensed by the Andreas Hettich GmbH & Co. KG company are allowed to be utilised.
- The following safety regulations apply:
EN / IEC 61010-1 and EN / IEC 61010-2-020 as well as their national deviations.
- The safe operation and reliability of the centrifuge can only be guaranteed if:
 - the centrifuge is operated in accordance with the operating instructions,
 - the electrical installation on the site where the centrifuge is installed conforms to the demands of EN / IEC stipulations.
- Meeting the country-specific requirements concerning occupational safety with regard to the use of laboratory centrifuges at the workplaces provided for this purpose by the user is the responsibility of the user.

4 Symbol meanings



Symbol on the device:
Attention, general hazard area.



Symbol on the device:
Observe operating instructions.
This symbol indicates that the user must observe the operating instructions provided.



Symbol in this document:
Attention, general hazard area.
This symbol refers to safety relevant warnings and indicates possibly dangerous situations.
The non-adherence to these warnings can lead to material damage and injury to personal.



Symbol on the device and in this document:
Beware of biohazard.



Symbol in this document:
This symbol refers to important circumstances.



Symbol on the device and in this document:
Symbol for the separate collection of electric and electronic devices according to the guideline 2002/96/EG (WEEE). The device belongs to Group 8 (medical devices).
Applies in the countries of the European Union, as well as in Norway and Switzerland.



Symbol on the shipping carton label:
This way up.



Symbol on the shipping carton label:
The shipping packaging must be transported and handled within the indicated humidity range (10% - 80%).



Symbol on the shipping carton label:
The shipping packaging must be stored, transported and handled within the temperature range shown (-20°C - +60°C).



Symbol on the shipping carton label:
The shipping packaging must be kept away from rain and kept in a dry environment.



Symbol on the shipping carton label:
Fragile, handle with care.

5 Delivery checklist

The following items and accessories are delivered with the centrifuge:

- 1 Connecting cable
- 2 Fuses
- 1 Lubricating grease for trunnions
- 1 Hex. pin driver
- 1 Release pin
- 1 Notes on moving the equipment safely
- 1 Operating instructions

The rotor(s) and associated accessories are included in the delivery in the quantity.

6 Unpacking the centrifuge

- Lift the carton upward and remove the padding.

-  Do not lift by the handle rail.
Observe the weight of the centrifuge, refer to chapter "Technical specifications".

Lift the centrifuge on both sides with an appropriate number of helpers and place it on the laboratory table.

7 Transport and storage

7.1 Transport

-  Before transporting the device, the transport securing device must be installed.

When the device and accessories are transported, the following ambient conditions must be complied with:

- Ambient temperature: -20°C to +60°C
- Relative humidity: 10% to 80%, non-condensing

7.2 Storage

-  The device and the accessories may only be stored in closed and dry rooms.

When the device and accessories are stored, the following ambient conditions must be complied with:

- Ambient temperature: -20°C to +60°C
- Relative humidity: 10% to 80%, non-condensing

8 Initial operation

- Remove the transportation safety device from the bottom of the housing, see sheet "Transportation safety device".
- **Position the centrifuge in a stable and level manner in a suitable place. During set-up, the required safety margin of 300 mm around the centrifuge is to be kept according to EN / IEC 61010-2-020.**



When the centrifuge is running, according to EN / IEC 61010-2-020, no persons, dangerous substances or objects may be within the safety margin of 300 mm around the centrifuge.

- Ventilation openings may not be blocked.
A distance of 300 mm must be maintained from the ventilation slots and openings of the centrifuge.
- Check whether the mains voltage tallies with the statement on the type plate.
- Connect the centrifuge with the power cord to a standard mains socket. For connection ratings refer to Chapter "Technical specifications".
- Turn on the mains switch. Switch position "I".
The last used centrifuge data will be displayed.
- Open the lid.

9 Opening and closing the lid

9.1 Opening the lid



The lid can only be opened when the centrifuge is switched on and the rotor is at rest. If it cannot be opened under these circumstances, see the section on "Emergency release".

- Swing handle rail on the lid upwards. The symbol "L" (lid open) illuminates in the rotation indicator Ⓒ.
- Open the lid.

9.2 Closing the lid



Do not bang the lid shut.

- Place the lid and swing handle rail on the lid downward. The symbol "—" (lid closed) illuminates in the rotation indicator Ⓒ.

10 Installation and removal of the rotor

10.1 Rotor with clamping nut

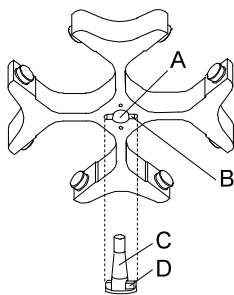

Rotor installation:



Dirt particles between the motor shaft and rotor prevent the rotor from having a perfect seat and cause it to run unsteadily.

- Clean the motor shaft (C) and the bore of the rotor (A) and then apply a thin coat of grease to the motor shaft.
- Place the rotor vertically onto the motor shaft. The driver of the motor shaft (D) must be in the groove of the rotor (B). The groove alignment is marked on the rotor.
- Tighten the clamping nut of the rotor by turning it in the clockwise direction using the key included in delivery.
- Check the rotor to make sure it is seated firmly.

Removing the rotor:

- Loosen the clamping nut by turning it in the counterclockwise direction up to the lifting pressure point. After overcoming the lifting pressure point, the rotor is released from the cone of the motor shaft.
- Turn the clamping nut until the rotor can be lifted up from the motor shaft.

10.2 Rotor without clamping nut

10.2.1 Installing and removing the hub

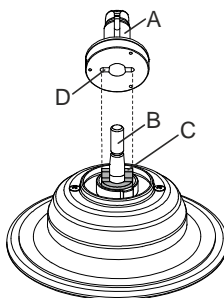

Installing the hub:

- Place the hub (A) vertically onto the motor shaft (B). The driver (C) on the motor shaft must be in the groove (D) of the hub.
- Tighten the clamping nut of the hub by turning it in the clockwise direction using the Allen key included in delivery.
- Check the hub to make sure it has a firm fit.

Removing the hub:

- Remove the rotor.
- Loosen the clamping nut of the hub by turning it counterclockwise up to the lifting pressure point. After overcoming the lifting pressure point, the hub is released from the cone of the motor shaft.
- Turn the clamping nut until the hub can be lifted up from the motor shaft.

10.2.2 Inserting and removing the rotor

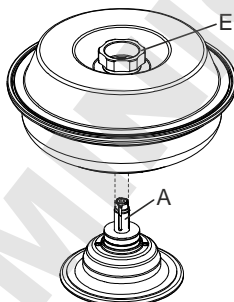

Inserting the rotor:



Dirt particles between the hub and rotor prevent the rotor from having a perfect seat and cause it to run unsteadily. If necessary, clean the hub (A) on the motor shaft and the rotor hub before inserting the rotor.

- Lift up the rotor by the turning handle (E) of the lid, place it horizontally on the hub (A) and press it down as far as it can go.

Removing the rotor:

- Hold firmly onto the rotor by the turning handle (E) of the lid and lift it off of the hub (A).

11 Inserting and removing hangers into/from the rotor

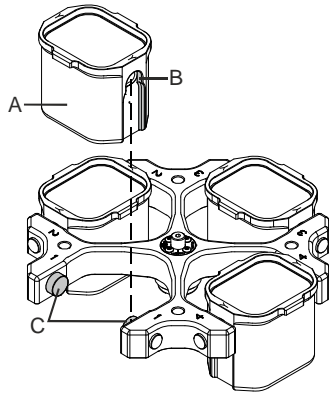

For swing-out rotors, all rotor places must be occupied with the **same** hangers.



Certain hangers are marked with the number of the rotor place. These hangers may only be inserted in the corresponding rotor place.
Hangers which are labelled with a set number, e.g. S001/4, may only be used in a set.

Inserting hangers in the rotor:

- Check the rotor to make sure it is seated firmly.
- Grease the lifting lug (C) (Hettich lubricating grease, no. 4051).
- Insert hangers (A) into the rotor. While doing so, make sure that the lifting lugs (C) are in the grooves (B) of the hangers.
- Push the hangers downward as far as they can go.

Removing hangers from the rotor:

- Pull the hangers (A) straight upward and out of the rotor.

12 Inserting and removing the adapters into/from the hangers

Inserting the adapters into the hangers:

- Insert the adapters (A) horizontally into the hangers (B).

Remove the adapters from the hangers:

- Remove the adapters (A) upward and out of the hangers (B).

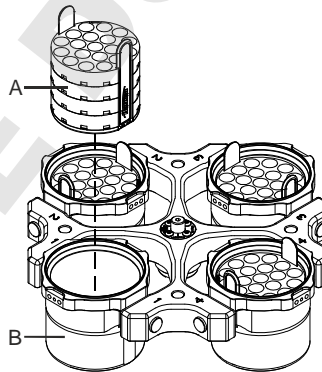
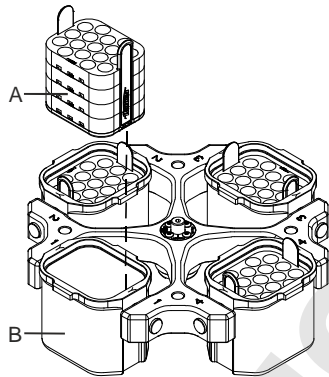

13 Inserting the adapter with positioning pin into the hanger

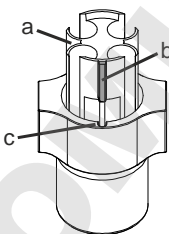

- Insert the adapter (a) into the hanger such that the positioning pin (b) is in the groove (c) of the hanger.



If the adapter (a) is not correctly inserted, the centrifuge containers could be damaged during the centrifugation run.

14 Loading the rotor



Standard centrifuge containers of glass will not stand RCF values exceeding 4000 (DIN 58970, pg. 2).

- Check the rotor for firm seating.
- With swing-out rotors all rotor positions must be lined with **identical** hangers. Certain hangers are marked with the number of the rotor position. These hangers may only be used in the respective rotor position. Hangers that are marked with a set number (e.g. S001/4) may only be used in the set.
- The rotors and hangers may only be loaded symmetrically. The centrifuge containers have to be distributed evenly on all rotor positions. For authorised combinations see Chapter "Anhang/Appendix, Rotoren und Zubehör/Rotors and accessories".
In the case of angle rotors all possible rotor positions must be loaded, see chapter "Anhang/Appendix, Rotoren und Zubehör/Rotors and accessories".

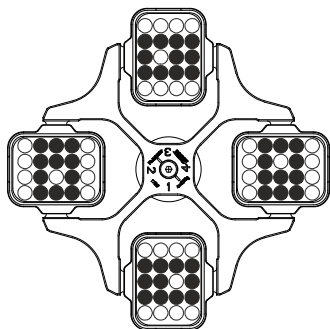

Rotor is loaded symmetrically.

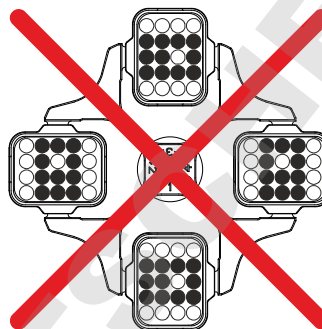

Not permitted!
Rotor is loaded asymmetrically.

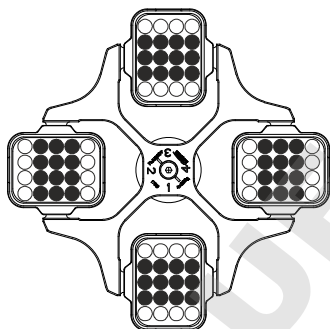

Rotor is evenly loaded

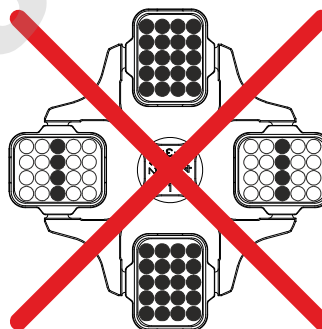

Not permitted!
Rotor is not evenly loaded

- On certain hangers, the weight of the maximum load or the weight of the maximum load and the maximum weight of the completely loaded hanger is specified. This weight may not be exceeded. In case of exception, see chapter "Centrifugation of materials or mixtures of materials with a density higher than 1.2 kg/dm³". The weight specification of the maximum load includes the total weight of the adapter, centrifuge container and contents.
- In containers with rubber inserts, the same number of rubber inserts must always be among the centrifuge containers.
- The centrifuge containers may only be filled outside of the centrifuge.

- The maximum filling quantity for the centrifuge containers specified by the manufacturer must not be exceeded. In the case of angle rotors, the centrifuging vessels may only be filled so far that no fluid can be expelled from them while the centrifuge is running.

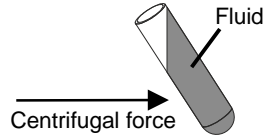

- When loading the angle rotors, no liquid may get into the angle rotors or centrifuging chamber.
- When loading the hangers and swing-out rotors and when swivelling out the hangers while the centrifuge is running, no liquid may enter the hangers or the centrifuging chamber.
- In order to maintain the weight differences within the centrifuge container as marginal as possible, a consistent fill level in the containers is to be heeded.

15 Closing biosafety systems



In order to guarantee that it is sealed, the lid to the biosafety system has to be firmly closed.

In order to prevent the packing ring from twisting when opening and closing the cover, the packing ring must be lightly rubbed with a rubber care product.

If the hanger of a biosafety system is used without the lid, the packing ring must be removed from the hanger in order to prevent the packing ring from being damaged during the centrifugation run. Damaged packing rings must not be used to seal the biosafety system.

For further details of available biosafety systems see chapter "Anhang/Appendix, Rotoren und Zubehör/Rotors and accessories". If in doubt, you should obtain relevant information from the manufacturer.

Lid with screw closure

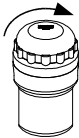

- Place the lid on the hanger.
- Tightly seal the lid by hand by turning it clockwise.

16 Control and display elements

See figure on page 2.

Fig. 2: Display and control panel

16.1 Symbols on the control panel



Rotation indicator. The rotation indicator lights up and rotates anticlockwise while the rotor is turning.

When the rotor is stationary, the status of the lid is displayed by symbols in the rotation indicator:

Symbol  : Lid open

Symbol  : Lid closed

Operator errors and occurring faults are indicated on the display (see Chapter "Faults").



16.2 Keys and setting options

RPM/RCF x 100



- Speed

A numeric value of 500 RPM up to the maximum rotor speed can be set. For maximum rotor speed, see chapter "Anhang/Appendix, Rotoren und Zubehör/Rotors and accessories". Preset in steps of 100 (RPM = displayed value x 100).

If the key  or  is kept pressed, the value changes with increasing speed.

- Display the brake step and the centrifuging radius.

t



- Running time

- Preset from 1 - 99 minutes, in 1 minute steps

- Continuous operation "--"

- Centrifuging radius. Input in centimeters. Preset from 5 - 16 centimeters, in 1 centimeter steps. For centrifuging radius, see chapter "Anhang/Appendix, Rotoren und Zubehör/Rotors and accessories".
- Braking steps 0 or 1. Step 1 = short run-down time, Step 0 = long run-down time.

If the key  or  is kept pressed, the value changes with increasing speed.



- Start centrifugation run.



- End centrifugation run.
The rotor runs down with the preselected brake step.
- Save the brake step and the centrifuging radius.



- Display of the relative centrifugal force (RCF).
The display of the relative centrifugal force (RCF) appears while the key  is kept pressed.





- Short-time centrifugation.
The centrifugation run occurs while the key  is kept pressed.
- Display the brake step and the centrifuging radius.

17 Setting the brake step

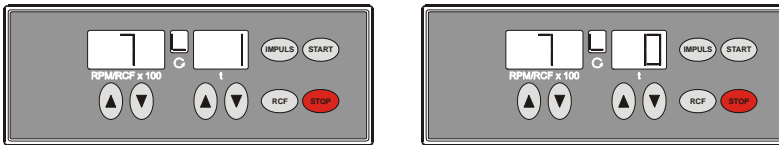

- Switch off the mains switch.
- Keep the key  beneath the speed indicator and the key **(IMPULS)** pressed simultaneously.
- Switch on the mains switch and release the keys again.

The speed indicator shows the machine version and the time indicator shows the set brake step: e.g.:





If the machine version and brake step are not displayed, press the  key under the speed indicator until they are displayed.

The machine version is set by the manufacturer and cannot be changed.

- Set the desired brake step with the keys   beneath the time indicator.
Step 1 = short run-down time, Step 0 = long run-down time.
For run-down times, see chapter "Anhang/Appendix, Rotoren und Zubehör/Rotors and accessories".
- Press the key **(STOP)** to save the setting.



18 Setting the centrifuging radius

 The centrifuging radius must be entered in centimeters.

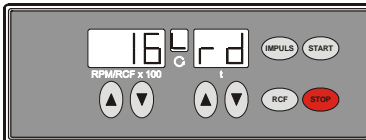
- Switch off the mains switch.
- Keep the key  beneath the speed indicator and the key **(IMPULS)** pressed simultaneously.
- Switch on the mains switch and release the keys again.
- Press the key  beneath the speed indicator until the following display appears:



The set centrifuging radius is displayed in the speed indicator.

- Set the desired centrifuging radius with the keys   beneath the time indicator.
For centrifuging radius, see chapter "Anhang/Appendix, Rotoren und Zubehör/Rotors and accessories".
- Press the key **(STOP)** to save the setting.



19 Centrifugation

 When the centrifuge is running, according to EN / IEC 61010-2-020, no persons, dangerous substances or objects may be within the safety margin of 300 mm around the centrifuge.

 If the permissible weight difference is exceeded within the rotor loading, the drive switches off during the run-up time, and error **-3-** is displayed (see chapter "Faults").

The centrifugation run can be interrupted at any time by pressing the key **(STOP)**.

The time and speed can be changed during the centrifugation run, with the keys  .

If the key  or  is kept pressed, the value changes with increasing speed.





After a centrifugation run, the display flashes until the cover is opened or a key is pressed.

If the symbol "—" (lid closed) and "L" (lid open) flashes alternately in the rotation indicator , operation of the centrifuge can only be continued after opening the lid.

If **rot xx** is displayed, no centrifugation run has taken place because the rotor has been changed, see chapter "Rotor Identification".

- Switch on the mains switch (switch position "I").
- Load the rotor and close the centrifuge cover.

19.1 Centrifugation with preselected time

- Set the desired speed with the keys   beneath the speed indicator.
- Set the desired time with the keys   beneath the time indicator.
- Press the key **[START]**. The rotation indicator  appears while the rotor is turning.







The time is displayed in minutes. The last minute is counted down in seconds.
When the time is displayed in minutes, a point flashes next to the number.

- After expiry of the time or if the centrifugation run is interrupted by pressing the key **[STOP]**, the rotor runs down with the set brake step.

During the centrifugation run, the rotor speed or the resulting RCF value and the remaining time are displayed.

19.2 Continuous operation

- Set the desired speed with the keys   beneath the speed indicator.
- Set the time to zero with the key  beneath the time indicator. "--" is displayed.
- Press the key **[START]**. The rotation indicator  appears while the rotor is turning. The time count starts from 0.





The first minute is counted up in seconds, and then the time is displayed in minutes.
When the time is displayed in minutes, a point flashes next to the number.

- Press the key **[STOP]** to end the centrifugation run. The rotor runs down with the set brake step.

During the centrifugation run, the rotor speed or the resulting RCF value and the expired time are displayed.

19.3 Short-time centrifugation

- Set the desired speed with the keys   beneath the speed indicator.
- Keep the key **[IMPULS]** pressed. The rotation indicator  appears while the rotor is turning. The time count starts from 0.



The first minute is counted up in seconds, and then the time is displayed in minutes.
When the time is displayed in minutes, a point flashes next to the number.

- Release the key **[IMPULS]** again to end the centrifugation run. The rotor runs down with the set brake step.

During the centrifugation run, the rotor speed and the expired time are displayed.

19.4 Display of the relative centrifugal force (RCF)

The relative centrifugal force (RCF) can be displayed during the centrifugation run.



If the relative centrifugal force (RCF) is used, the centrifuging radius must be entered.

- Keep the key **[RCF]** pressed during the centrifugation run.
The relative centrifugal force (RCF) appears in the speed indicator (RCF = displayed value x 100).
- Release the key **[RCF]** again. The speed is displayed.



20 Acoustic signal

The acoustic signal sounds:

- After a disturbance occurs, in 2 second intervals.
- After completion of a centrifugation run and rotor standstill in 30 second intervals.

The acoustic signal is stopped by opening the lid or pressing any key.

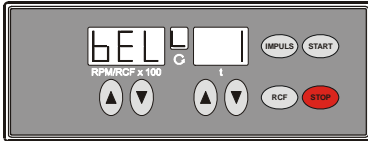

The acoustical signal can be activated or deactivated as follows when the rotor is at a standstill:

- Switch off the mains switch.
- Keep the key  beneath the speed indicator and the key **[IMPULS]** pressed simultaneously.
- Switch on the mains switch and release the keys again.
- Press the key  beneath the speed indicator until the following display appears:



The acoustical signal setting is displayed on the time display.

0 = acoustical signal deactivated, 1 = acoustical signal activated.

- With the   keys below the time display, set **0** or **1**.
- Press the key **[STOP]** to save the setting.

21 Relative centrifugal force (RCF)

The relative centrifugal force (RCF) is given as a multiple of the acceleration of gravity (g). It is a unit-free value and serves to compare the separation and sedimentation performance.

These values are calculated using the formula below:

$$\text{RCF} = \left(\frac{\text{RPM}}{1000} \right)^2 \times r \times 1,118 \quad \Rightarrow \quad \text{RPM} = \sqrt{\frac{\text{RCF}}{r \times 1,118}} \times 1000$$

RCF = relative centrifugal force

RPM = rotational speed (revolutions per minute)

r = centrifugal radius in mm = distance from the centre of the turning axis to the bottom of the centrifuge container. For more on the centrifugal radius see the chapter "Anhang/Appendix, Rotoren und Zubehör/Rotors and accessories".



The relative centrifugal force (RCF) stands in relation to the revolutions per minute and the centrifugal radius.

22 Centrifugation of materials or mixtures of materials with a density higher than 1.2 kg/dm³

When centrifuging with maximum revolutions per minute the density of the materials or the material mixtures may not exceed 1.2 kg/dm³.

The speed must be reduced for materials or mixtures of materials with a higher density.

The permissible speed can be calculated using the following formula:

$$\text{Reduced speed } (n_{\text{red}}) = \sqrt{\frac{1.2}{\text{Greater density [kg/dm}^3]}} \times \text{maximum speed [RPM]}$$

e.g.: maximum speed RPM 4000, density 1.6 kg/dm³

$$n_{\text{red}} = \sqrt{\frac{1.2 \text{ kg/dm}^3}{1.6 \text{ kg/dm}^3}} \times 4000 \text{ RPM} = 3464 \text{ RPM}$$

In the exceptional case that the maximum loading indicated on the hanger is exceeded, the speed must also be reduced.

The permissible speed can be calculated using the following formula:

$$\text{Reduced speed } (n_{\text{red}}) = \sqrt{\frac{\text{maximum load [g]}}{\text{actual load [g]}}} \times \text{maximum speed [RPM]}$$

e.g.: maximum speed RPM 4000, maximum load 300 g, actual load 350 g

$$n_{\text{red}} = \sqrt{\frac{300 \text{ g}}{350 \text{ g}}} \times 4000 \text{ RPM} = 3703 \text{ RPM}$$

If in doubt you should obtain clarification from the manufacturer.

23 Rotor recognition

Rotor recognition is carried out after each start of the centrifugation run.

If the rotor has been changed, the centrifugation run is canceled after rotor recognition. The rotor code (red xx) of the rotor is displayed.

- Press the key **START**. The last used centrifuge data will be displayed.



A further operation of the centrifuge is only possible after a single opening of the lid.

If the maximum speed of the rotor being used is less than the set speed, the speed is limited to the rotor's maximum speed.

24 Emergency release

The lid cannot be opened during power failure. An emergency release has to be executed by hand.



For emergency release disconnect the centrifuge from the mains.

Open the lid only during rotor standstill.

Only the plastic release pin provided may be used for emergency release.

See figure on page 2.

- Switch off the mains switch (switch position "0").
- Look through the window in the lid to be sure that the rotor has come to a standstill.
- Insert the release pin horizontally into the hole (fig. 1, A). Push the unlocking pin in until the handle can be lifted when the pin is pressed down.
- Open the lid.

25 Maintenance and servicing



The device can be contaminated.



Pull the mains plug before cleaning.

Before any other cleaning or decontamination process other than that recommended by the manufacturer is applied, the user has to check with the manufacturer that the planned process does not damage the device.

- Centrifuges, rotors and accessories must not be cleaned in rinsing machines.
- They may only be cleaned by hand and disinfected with liquids.
- The water temperature must be between 20 – 25°C.
- Only detergents/disinfectants may be used which:
 - have a pH between 5 - 8
 - do not contain caustic alkalis, peroxides, chlorine compounds, acids and alkaline solutions
- In order to prevent appearances of corrosion through cleaning agents or disinfectants, the application guide from the manufacturer of the cleaning agent or disinfectant are absolutely to be heeded.

25.1 Centrifuge (housing, lid and centrifuging chamber)

25.1.1 Surface cleaning and care

- Clean the centrifuge housing and the centrifuging chamber regularly, using soap or a mild detergent and a damp cloth if required. For one thing, this services purposes of hygiene, and it also prevents corrosion through adhering impurities.
- Ingredients of suitable detergents: soap, anionic tensides, non-ionic tensides.
- After using detergents, remove the detergent residue by wiping with a damp cloth.
- The surfaces must be dried immediately after cleaning.
- In the event of condensation water formation, dry the centrifugal chamber by wiping out with an absorbent cloth.
- Lightly rub the rubber seal of the centrifuge chamber with a rubber care product after each cleaning.
- The centrifuging chamber is to be checked for damage once a year.



If damage is found which is relevant to safety, the centrifuge may no longer be put into operation. In this case, notify Customer Service.

25.1.2 Surface disinfection

- If infectious materials penetrates into the centrifugal chamber this is to be disinfected immediately.
- Ingredients of suitable disinfectants: ethanol, n-propanol, ethyl hexanol, anionic tensides, corrosion inhibitors.
- After using disinfectants, remove the disinfectant residue by wiping with a damp cloth.
- The surfaces must be dried immediately after disinfecting.

25.1.3 Removal of radioactive contaminants

- The agent must be specifically labelled as being an agent for removing radioactive contaminants.
- Ingredients of suitable agents for removing radioactive contaminants: anionic tensides, non-ionic tensides, polyhydrated ethanol.
- After removing the radioactive contaminants, remove the agent residue by wiping with a damp cloth.
- The surfaces must be dried directly after removing the radioactive contaminants.

25.2 Rotors and Attachments

25.2.1 Cleaning and care

- In order to avoid corrosion and changes in materials, the rotors and accessories have to be cleaned regularly with soap or with a mild cleaning agent and a moist cloth. Cleaning is recommended at least once a week. Contaminants must be removed immediately.
- Ingredients of suitable detergents:
soap, anionic tensides, non-ionic tensides.
- After using detergents, remove detergent residue by rinsing with water (only outside of the centrifuge) or wipe off with a damp cloth.
- The rotors and accessories must be dried directly after cleaning.
- Angle rotors, container and hanger made of aluminium are to be lightly greased after drying using acid-free grease, e.g. vaseline.
- The sealing rings of bio-safety systems must be cleaned weekly.
The sealing rings are made of silicone. To guarantee the leak-tightness of the bio-safety systems, the sealing rings must not be handled with talcum powder after cleaning or autoclaving.
Each time before using the bio-safety system, all parts of the bio-safety system must be visually inspected for damage. In addition, the sealing ring(s) of the bio-safety system must be checked to make sure they are in the correct installation position.
Damaged parts of the bio-safety system must be exchanged immediately.
If there are signs of crack formation, brittleness or wear, immediately replace the sealing ring in question. In the case of lids with sealing rings which cannot be replaced, the entire lid must be exchanged.
For the available bio-safety systems, see the chapter "Appendix, Rotors and accessories".
- In order to prevent corrosion as a result of moisture between the rotor and the motor shaft, the rotor should be disassembled and cleaned at least once a month, and the motor shaft should be lightly greased.
- The rotors and accessories have to be checked weekly for wear and corrosion. For swing-out rotors, it is important to check the area of the lifting lugs, for hangers, the grooves and the base should be checked for cracks.

Example: Crack in the groove area:



 Rotors and attachments may no longer be utilised upon indication of wear and tear or corrosion.

- Check the firm seating of the rotor on a weekly basis.

25.2.2 Disinfection

- If infectious material should get on the rotors or accessories, they must be appropriately disinfected.
- Ingredients of suitable disinfectants:
ethanol, n-propanol, ethyl hexanol, anionic tensides, corrosion inhibitors.
- After using disinfectants, remove disinfectant residue by rinsing with water (only outside of the centrifuge) or wipe off with a damp cloth.
- The rotors and accessories must be dried directly after disinfection.

25.2.3 Removal of radioactive contaminants

- The agent must be specifically labelled as being an agent for the removal of radioactive contaminants.
- Ingredients of suitable agents for removing radioactive contaminants:
anionic tensides, non-ionic tensides, polyhydrated ethanol.
- After removing the radioactive contaminants, remove agent residue by rinsing with water (only outside of the centrifuge) or wipe off with a damp cloth.
- The rotors and accessories must be dried directly after removing the radioactive contaminants.

25.2.4 Trunnions

With swing-out rotors the trunnions must be regularly lubricated (Hettich Lubricating Grease No. 4051) in order to ensure consistent swinging out of the hangers.

25.2.5 Rotors and accessories with limited service lives

The use of certain rotors, hangers and accessory parts is limited by time.

These are marked with the maximum permitted number of operating cycles or with an expiration date and the maximum permitted number of operating cycles or just with the expiration date; e.g.:

- "einsetzbar bis Ende: IV. Quartal 2011 / usable until end of: IV. Quarter 2011" or "einsetzbar bis Ende Monat/Jahr: 10/2011 / usable until end of month/year: 10/2011"
- "Max. Lauf Zyklen / max. cycles: 40000".



For safety reasons, rotors, hangers and accessory parts may no longer be used if either the indicated maximum number of operating cycles or the indicated expiration date has been reached.

25.3 Autoclaving

The following accessories may be autoclaved at 121°C / 250°F (20 min):

- Swing-out rotors
- Angle rotors made of aluminium
- Hangers made of metal
- Lid with bio-seal
- Adapter

Nothing definitive can be said about the degree of sterility.



The lids of the rotors and containers must be removed before autoclaving.

Autoclaving accelerates the ageing process of plastics. In addition, it can cause discolourations in plastics.

After autoclaving, the rotors and the accessories must be visually inspected for damage and any damaged parts must be exchanged immediately.

If there are signs of crack formation, brittleness or wear, immediately replace the sealing ring in question.

In the case of lids with sealing rings which cannot be replaced, the entire lid must be exchanged.

To guarantee the leak-tightness of the bio-safety systems, the sealing rings must not be handled with talcum powder after autoclaving.

25.4 Centrifuge containers

- With leakiness or after the breakage of centrifuging containers broken container parts, glass splinters and leaked centrifugation material are to be completely removed.
- The rubber inserts as well as the plastic sleeves of the rotors are to be replaced after a glass breakage.



Remaining glass splinters cause further glass breakage!

- If this concerns infectious material, a disinfection process is to be executed immediately.

26 Faults

If the fault cannot be eliminated with the help of the fault table, please inform Customer Service.

Please specify the type of centrifuge and the serial number. Both numbers can be found on the name plate of the centrifuge.

	<p>Perform a MAINS RESET:</p> <ul style="list-style-type: none"> - Switch off the mains switch (switch position "0"). - Wait at least 10 seconds and then switch on the mains switch again (switch position "1").
---	---

Fault	Display	Cause of fault	Remedy
No display	---	No voltage Mains input fuses defective.	<ul style="list-style-type: none"> - Check distribution voltage. - Check mains power input fuse, refer to Chapter "Change mains input fuse". - Mains switch ON.
Tacho error	- 1 -	Failure of speed impulses during operation.	<ul style="list-style-type: none"> - The device may not be switched off as long as the rotation display  is lit up and rotating. Wait until the  icon (lid closed) appears in the rotation display (after about 100 seconds) and then run a "POWER RESET".
System reset	- 2 -	Power failure during the centrifugation run. (The centrifugation run was not finished.)	<ul style="list-style-type: none"> - When stationary, open lid and press  key. - Repeat the centrifugation run if necessary.
Balance error	- 3 -	The rotor is unevenly loaded.	<ul style="list-style-type: none"> - Open lid when rotor is stationary. - Check the loading of the rotor, see chapter "Loading the rotor". - Repeat the centrifugation run.
Communication	- 4 -	Fault in control unit or power unit.	<ul style="list-style-type: none"> - Perform a MAINS RESET when the rotor has been stationary.
Overload	- 5 -	Motor or motor control defective.	<ul style="list-style-type: none"> - Perform a MAINS RESET when the rotor has been stationary.
Overvoltage Undervoltage	- 6 - - 8 -	Supply voltage outside tolerance (see Technical Data).	<ul style="list-style-type: none"> - Perform a MAINS RESET when the rotor has been stationary. - Check supply voltage.
Overspeed	- 7 -	Fault in the power unit.	<ul style="list-style-type: none"> - Perform a MAINS RESET when the rotor has been stationary
Excess temperature	- 9 -	Excess temperature switch in motor has triggered.	<ul style="list-style-type: none"> - When rotor is stationary, open lid using emergency unlocking (see Emergency Unlocking chapter). - Allow motor to cool down.
Version error	A number is displayed in the time indicator.	Incorrect machine version set, control unit jumps into Setting menu.	<ul style="list-style-type: none"> - Set the number 4 using the   keys underneath the time indicator. - Press the key  to save the setting. - Perform a MAINS RESET.
Controller watchdog	- C -	Fault in control unit.	<ul style="list-style-type: none"> - Perform a MAINS RESET when the rotor has been stationary.
Lid error	- d -	Error in lid locking or lid closure.	<ul style="list-style-type: none"> - Perform a MAINS RESET when the rotor has been stationary.
Short circuit	- E -	Short circuit in control unit / power unit.	<ul style="list-style-type: none"> - Perform a MAINS RESET when the rotor has been stationary.
No rotor code	- F -	No rotor recognition at start. No rotor fitted or defective tacho.	<ul style="list-style-type: none"> - Perform a MAINS RESET when the rotor has been stationary.
New rotor identified	rot...	see section rotor identification.	<ul style="list-style-type: none"> - Press the key .

27 Change mains input fuses



Switch off the mains switch and separate the device from the mains!

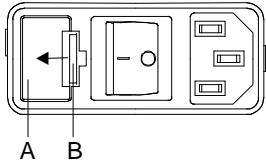

The fuse holder (A) with the mains input fuses is located next to the mains switch.

- Remove the connecting cable from the machine plug socket.
- Press the snap-fit (B) against the fuse holder (A) and remove.
- Exchange defective mains input fuses.



Only use fuses with the rating defined for the type. See the following table.

- Reinsert the fuse holder until the snap-fit clicks shut.
- Reconnect the device to the mains supply.

Model	Type	Fuse	Order no.
ROTOFIX 32 A	1206, 1206-34	T 3.15 AH/250V	E997
ROTOFIX 32 A	1206-01, 1206-33	T 5 AH/250V	E914

28 Returning Devices



Before returning the device, a transport securing device has to be installed.

If the device or its accessories are returned to Andreas Hettich GmbH & Co. KG, in order to provide protection for people, the environment and materials, it has to be decontaminated and cleaned before being shipped.

We reserve the right to refuse contaminated devices or accessories.

Costs incurred for cleaning and disinfection are to be charged to the customer.

We ask for your understanding in this matter.

29 Disposal

Before disposal, the device must be decontaminated and cleaned to protect people, the environment and property.

When you are disposing of the device, the respective statutory rules must be observed.

Pursuant to guideline 2002/96/EC (WEEE), all devices supplied after August 13, 2005 may not be disposed as part of domestic waste. The device belongs to group 8 (medical devices) and is categorized in the business-to-business field.



The icon of the crossed-out trash can shows that the device may not be disposed as part of domestic waste.

The waste disposal guidelines of the individual EC countries might vary. If necessary, contact your supplier.

Table des matières

1	Usage conforme	55
2	Risques résiduels	55
3	Données techniques	55
4	Consignes de sécurité	56
5	Signification des symboles.....	58
6	Composition de la livraison	59
7	Déballer la centrifugeuse	59
8	Transport et stockage	59
8.1	Transport	59
8.2	Stockage.....	59
9	Mise en service.....	60
10	Ouvrir et fermer le couvercle	60
10.1	Ouvrir le couvercle	60
10.2	Fermer le couvercle	60
11	Montage et démontage du rotor	61
11.1	Rotor avec écrou.....	61
11.2	Rotor sans écrou.....	61
11.2.1	Montage et démontage du moyeu	61
11.2.2	Insérer et retirer le rotor	61
12	Insérer et retirer les suspensions dans le rotor.....	62
13	Insérer et retirer les adaptateurs dans les suspensions	62
14	Poser dans le balancier l'adaptateur avec tenon de positionnement.....	62
15	Chargement du rotor	63
16	Fermeture des systèmes de sécurité biologique	64
17	Organes de commande et indicateurs.....	65
17.1	Symboles du tableau de commande	65
17.2	Touches et possibilités de réglage	65
18	Régler le niveau de freinage	66
19	Régler le rayon de centrifugation.....	66
20	Centrifugation	67
20.1	Centrifugation après présélection du temps.....	67
20.2	Fonctionnement continu.....	67
20.3	Centrifugation de courte durée.....	67
20.4	Affichage de l'accélération centrifuge relative (RCF)	68
21	Signal acoustique	68
22	Accélération centrifuge relative (RCF).....	68
23	Centrifugation de matières et de mélanges d'une densité supérieure à 1,2 kg/dm ³	69
24	Identification du rotor	69
25	Déverrouillage d'urgence.....	69
26	Entretien et maintenance	70
26.1	Centrifugeuse (boîtier, couvercle et cuve).....	70
26.1.1	Entretien et nettoyage des surfaces.....	70
26.1.2	Désinfection des surfaces	70

26.1.3	Décontamination de substances radioactives.....	70
26.2	Rotors et accessoires	71
26.2.1	Nettoyage et entretien	71
26.2.2	Désinfection	71
26.2.3	Décontamination de substances radioactives.....	72
26.2.4	Goupilles de fixation	72
26.2.5	Rotors et accessoires à durée d'utilisation limitée	72
26.3	Autoclave	72
26.4	Réservoirs de centrifugation	72
27	Défauts.....	73
28	Changer les fusibles d'entrée de secteur	74
29	Renvoi d'appareils au fabricant	74
30	Élimination des déchets	74
31	Anhang / Appendix.....	97
31.1	Rotoren und Zubehör / Rotors and accessories.....	97

1 Usage conforme

L'appareil dont il est question est un produit médical (centrifugeuse de laboratoire) dans l'esprit de la directive IVD 98/79/CE.

La centrifugeuse sert à la séparation de substances ou mélanges de substances d'une densité maximum de 1,2 kg/dm³. Ce qui comprend, en particulier, tout prélèvement destiné à la préparation de diagnostics In-vitro dans le cadre de la médecine humaine.

La centrifugeuse est exclusivement destinée à cette plage d'utilisation.

Toute utilisation en dehors ou au delà de ce cadre est considérée comme non conforme. L'entreprise Andreas Hettich GmbH & Co. KG décline toute responsabilité pour tout dommage en résultant.

L'utilisation conforme comprend également le respect de toutes les indications contenues dans le mode d'emploi et des travaux d'inspection et d'entretien.

2 Risques résiduels

L'appareil est construit conformément au niveau actuel de la technologie et des règles de sécurité éprouvées. L'utilisation et la manipulation non conforme de cet appareil risquent de menacer la santé et l'intégrité corporelle de l'utilisateur ou de tierces personnes, ou de détériorer l'appareil ou autres biens matériels. Utilisez exclusivement l'appareil conformément à l'usage pour lequel il a été conçu et uniquement s'il est dans un état de fonctionnement technique irréprochable.

Remédier sans attendre à tout dérangement susceptible de porter atteinte à la sécurité.

3 Données techniques

Fabricant	Andreas Hettich GmbH & Co. KG D-78532 Tuttlingen	
Modèle	ROTOFIX 32 A	
Type	1206 1206-34	1206-01 1206-33
Tension du réseau (± 10%)	208 – 240 V 1~	100 – 127 V 1~
Fréquence du réseau	50 – 60 Hz	50 – 60 Hz
Charge de connexion	300 VA	300 VA
Consommation de courant	1.4 A	3.0 A
Capacité max.	4 x 100 ml / 32 x 15 ml	
Densité admise	1.2 kg/dm ³	
Vitesse de rotation (RPM)	6000	
Accélération (RCF)	4226	
Energie cinétique	3160 Nm	
Obligation de contrôle (DGUV Regel 100 – 500)	non	
Conditions ambiantes (EN / IEC 61010-1)	uniquement dans les intérieurs Jusqu'à 2000 m au dessus du niveau de la mer 2°C à 40°C humidité de l'air max. relative 80% pour températures jusqu'à 31°C, décroissant en linéaire jusqu'à 50% de l'humidité relative pour 40°C.	
– Emplacement		
– Hauteur		
– Température ambiante		
– Humidité de l'air		
– Catégorie de surtension (IEC 60364-4-443)	II	
– Degré d'encrassement	2	
Catégorie de protection de l'appareil	I	
Non approprié pour l'usage dans un environnement exposé aux explosions.		
EMV		
– Emission de parasites, Résistance aux interférences	EN / IEC 61326-1, catégorie B	FCC Class B
Niveau du bruit (en fonction du rotor)	≤ 57 dB(A)	
Dimensions		
– Largeur	366 mm	
– Profondeur	430 mm	
– Hauteur	257 mm	
Poids	23 kg	

4 Consignes de sécurité



Aucune demande garantie ne pourra être revendiquée auprès du fabricant si les indications données dans ce mode d'emploi ne sont pas toutes respectées.



- **Veiller à la stabilité de la centrifugeuse.**
- **Avant d'utiliser la centrifugeuse, il est indispensable de vérifier la fixation correcte du rotor.**
- **Durant un processus de centrifugation, aucune personne, matière dangereuse et aucun objet ne doivent se trouver dans une zone de sécurité de 300 mm autour de la centrifugeuse selon EN / IEC 61010-2-020.**
- **Les rotors, balanciers et accessoires qui présentent d'importantes traces de corrosion ou des défauts mécaniques ou dont la durée d'utilisation a expiré ne doivent plus être utilisés.**
- **Suspendre immédiatement l'utilisation de la centrifugeuse si la cuve de centrifugeuse présente des dommages susceptibles de porter atteinte à la sécurité.**
- **Les goupilles de fixation des rotors à amortissement doivent être graissées régulièrement (graisse de lubrification Hettich n° 4051) de manière à assurer le balancement régulier de la suspension.**
- **Concernant les centrifugeuses sans réglage de température, il peut y avoir un réchauffement dans la cuve de centrifugeuse en cas de température ambiante élevée et/ou d'utilisation fréquente de l'appareil. Il n'est donc pas possible d'exclure une modification de l'échantillon due à la température.**

- **Il importe de lire et de respecter le mode d'emploi avant la mise en service de la centrifugeuse. Seules les personnes ayant lu et compris le mode d'emploi sont autorisées à manipuler l'appareil.**
- Outre le mode d'emploi et les réglementations contraignantes relatives à la prévention des accidents, il importe également de respecter les règles spécifiques et communément admises en matière de sécurité et de travail. Le mode d'emploi doit être complété des dispositions nationales applicables à la prévention des accidents et à la protection de l'environnement.
- La centrifugeuse a été construite conformément à l'état actuel de la technique et son fonctionnement est sûr. Elle peut cependant présenter des dangers pour l'utilisateur ou des tiers si son utilisation n'est pas confiée à un personnel dûment formé, est inadéquate ou non conforme à sa destination.
- Pendant le fonctionnement, la centrifugeuse ne devra pas être déplacée ou être heurtée.
- En cas de défaillance ou en cas de déverrouillage d'urgence, ne jamais intervenir dans l'appareil lorsque le rotor tourne.
- Afin d'éviter les dommages causés par la condensation en passant d'un local froid à un local chaud, il faut soit réchauffer la centrifugeuse en la laissant pendant au moins 3 heures dans le local chaud avant de la raccorder au secteur, soit la faire fonctionner pendant 30 minutes dans le local froid pour la chauffer.
- Pour cet appareil, vous ne devez utiliser que des rotors et des accessoires homologués par le fabricant (voir chapitre "Anhang/Appendix, Rotoren und Zubehör/Rotors and accessories"). Avant d'utiliser des récipients de centrifugation qui ne sont pas présentés dans le chapitre "Annexe/Appendix, rotors et accessoire/Rotors and accessories", l'utilisateur doit s'assurer auprès du fabricant qu'il peut les utiliser.
- Le rotor de la centrifugeuse doit uniquement être chargé conformément au chapitre "Chargement du rotor".
- Dans le cas de la centrifugation à la vitesse maximale, la densité des substances et des mélanges de substances ne doit pas excéder 1,2 kg/dm³.
- Il est interdit de procéder à des centrifugations en présence de défauts d'équilibrage.
- La centrifugeuse ne doit pas être exploitée dans un environnement explosif.
- Il est interdit de procéder à des centrifugations :
 - avec des matières inflammables ou explosives,
 - avec des matières susceptibles de réagir chimiquement ou de dégager d'importantes quantités d'énergie.

- L'utilisateur est tenu de prendre des mesures appropriées lors de la centrifugation de substances, ou mélanges de substances, dangereuses qui sont contaminées de manière toxique, radioactive ou par des microorganismes pathogènes.
De manière générale, utiliser des réservoirs de centrifugation avec fermeture à vis spéciales pour substances dangereuses. Concernant les matériaux du groupe à risque 3 et 4, utilisez, en plus des réservoirs de centrifugation verrouillables, un système de biosécurité (voir manuel "Laboratory Bio-safety Manual" de l'Organisation Mondiale de la Santé).
Dans un système de biosécurité, une bio-étanchéité (bague d'étanchéité) empêche les fuites de gouttes et d'aérosols.
Si vous employez le balancier d'un système de biosécurité sans le couvercle, il faut retirer la bague d'étanchéité du balancier afin d'éviter que la bague d'étanchéité soit endommagée pendant le cycle de centrifugation.
Tout système de biosécurité défectueux n'est plus étanche du point de vue microbiologique.
Une centrifugeuse utilisée sans système de biosécurité n'est plus étanche du point de vue microbiologique dans l'esprit de la norme NE / IEC 61010-2-020.
Veuillez suivre les instructions au chapitre "Fermeture des systèmes de sécurité biologique" lorsque vous fermez un système de biosécurité.
Vous trouverez au chapitre "Annexe/Appendix, rotors et accessoires/Rotors and accessories" la liste des systèmes de biosécurité pouvant être livrés. En cas de doute, veuillez vous renseigner auprès du fabricant.
- Il est interdit de centrifuger des matières fortement corrosives pouvant réduire la résistance mécanique des rotors, des supports et des accessoires.
- Les réparations ne peuvent être effectuées que par une personne autorisée à cet effet par le fabricant.
- Utiliser uniquement les pièces de rechange originales et les accessoires d'origine homologués par les Etablissements Andreas Hettich GmbH & Co. KG.
- Les dispositions de sécurité suivantes font foi :
EN / IEC 61010-1 et EN / IEC 61010-2-020 ainsi que les dérogations nationales.
- La sécurité et la fiabilité de la centrifugeuse seront uniquement garanties si :
 - la centrifugeuse est utilisée conformément aux instructions du mode d'emploi,
 - l'installation électrique du site de la centrifugeuse est conforme aux prescriptions EN / IEC.
- Le fait de respecter les prescriptions nationales relatives à la sécurité au travail concernant l'utilisation de centrifugeuses de laboratoire sur le lieu de travail prévu à cet effet par l'exploitant relève de la responsabilité du dit exploitant.

5 Signification des symboles



Symbole sur l'appareil :
Attention, zone de danger général.



Symbole sur l'appareil :
respecter le mode d'emploi.
Ce symbole indique que l'utilisateur doit respecter le mode d'emploi mis à disposition.



Symbole dans ce document:
Attention, zone de danger général.
Ce symbole indique des consignes de sécurité et signale des situations pouvant être sources de danger.
Le non-respect de ces instructions peut entraîner des dégâts matériels et personnels.



Symbole sur l'appareil et dans ce document:
Avertissement de menace biologique pour l'environnement.



Symbole dans ce document:
Ce symbole signale des informations importantes.



Symbole sur l'appareil et dans ce document:
Symbole pour la collecte séparée des appareils électriques et électroniques, conformément à la directive 2002/96(EG (WEEE). L'appareil fait partie du groupe 8 (appareils de médecine).
Utilisation dans les pays de l'Union Européenne ainsi qu'en Norvège et en Suisse.



Symbole sur l'emballage :
Ce côté vers le haut.



Symbole sur l'emballage :
Stocker, transporter et manipuler l'emballage pour le transport à l'intérieur de la plage d'humidité affichée (10% - 80%).



Symbole sur l'emballage :
Stocker, transporter et manipuler l'emballage d'expédition à l'intérieur de la plage de température affichée (-20°C - +60°C).



Symbole sur l'emballage :
Tenir l'emballage pour le transport éloigné de la pluie et le stocker dans un endroit sec.



Symbole sur l'emballage :
Fragile, manipuler avec précaution.

6 Composition de la livraison

Les accessoires suivants sont fournis avec la centrifugeuse:

- 1 Câble de connexion
- 2 Fusible
- 1 Graisse pour tourillon porteur
- 1 Clé mâle coudée
- 1 Tige de déverrouillage
- 1 Fiche de consignes pour le transport
- 1 Mode d'emploi

Le(s) rotor(s) et accessoires correspondant sont livrés selon les spécifications de la commande.

7 Déballer la centrifugeuse

- Soulever le carton et retirer le matériau d'amortissement.

-  Ne pas utiliser la poignée du couvercle pour soulever. Tenir compte du poids de la centrifugeuse, voir au chapitre "Données techniques".

Avec un nombre suffisant d'aides, soulever la centrifugeuse sur les deux faces et la déposer sur la table de laboratoire.

8 Transport et stockage

8.1 Transport

-  Installer le dispositif de sécurité pour le transport avant de transporter l'appareil.

Respecter les conditions ambiantes suivantes pour transporter l'appareil et ses accessoires :

- Température ambiante : -20°C à +60°C
- Humidité relative de l'air : 10% à 80%, non condensante

8.2 Stockage

-  Ne stocker l'appareil et ses accessoires que dans une pièce fermée au sec.

Respecter les conditions ambiantes suivantes pour stocker l'appareil et ses accessoires :

- Température ambiante : -20°C à +60°C
- Humidité relative de l'air : 10% à 80%, non condensante

9 Mise en service

- Retirer du fond du carter les dispositifs de sécurité pour le transport, voir pour cela la fiche de données "Dispositifs de sécurité pour le transport".
- **Placer la centrifugeuse sur un emplacement approprié de manière à ce qu'elle soit stable et mettre de niveau. Lors de la mise en place, il faut respecter la zone de sécurité exigée de 300mm autour de la centrifugeuse selon EN / IEC 61010-2-020.**



Durant un processus de centrifugation, aucune personne, matière dangereuse et aucun objet ne doivent se trouver dans une zone de sécurité de 300 mm autour de la centrifugeuse selon EN / IEC 61010-2-020.

- Ne pas recouvrir les fentes d'aération.
Veuillez respecter un écart de 300 mm jusqu'aux fentes et ouvertures d'aération de la centrifugeuse.
- Vérifier que la tension de secteur est identique à la mention de la plaque signalétique.
- Brancher la centrifugeuse avec son cordon de raccordement sur une prise secteur aux normes. Puissance connectée voir chapitre "Données techniques".
- Activer l'interrupteur de secteur. Amener l'interrupteur en position "I".
Les dernières données de centrifuge utilisées s'affichent.
- Ouvrir le capot.

10 Ouvrir et fermer le couvercle

10.1 Ouvrir le couvercle



Le capot ne peut être ouvert que lorsque la centrifugeuse est sous tension et que le rotor est à l'arrêt. Dans les autres cas, voir le chapitre, "Déverrouillage d'urgence".

- Faire pivoter la baguette de la poignée du couvercle vers le haut. Le symbole "L" (couvercle ouvert) est allumé dans l'affichage de la rotation
- Ouvrir le capot.

10.2 Fermer le couvercle



Ne pas laisser tomber le couvercle pour le fermer.

- Poser le couvercle dessus et faire pivoter la baguette de la poignée du couvercle vers le bas. Le symbole "—" (couvercle fermé) est allumé dans l'affichage de la rotation

11 Montage et démontage du rotor

11.1 Rotor avec écrou

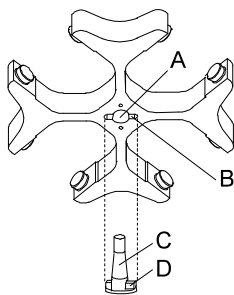

Montage du rotor :

 La présence d'impuretés entre l'arbre moteur et le rotor empêche au rotor d'avoir une position parfaite, et provoque un fonctionnement irrégulier du rotor.

- Nettoyer l'arbre moteur (C) et l'ouverture du rotor (A), graisser ensuite légèrement l'arbre moteur.
- Placer le rotor à la verticale sur l'arbre moteur. L'entraîneur de l'arbre moteur (D) doit se trouver dans la rainure du rotor (B). La direction de la rainure est indiquée sur le rotor.
- Serrer l'écrou du rotor à l'aide de la clé fournie, en tournant dans le sens des aiguilles d'une montre.
- Vérifier si le rotor se trouve dans une position fixe.

Démontage du rotor :

- Desserrer l'écrou en tournant dans le sens inverse des aiguilles d'une montre, et tourner jusqu'au point de pression pour le retrait. Après avoir franchi ce point de pression, le rotor se détache du cône de l'arbre moteur.
- Tourner l'écrou jusqu'à pouvoir soulever le rotor de l'arbre moteur.

11.2 Rotor sans écrou

11.2.1 Montage et démontage du moyeu

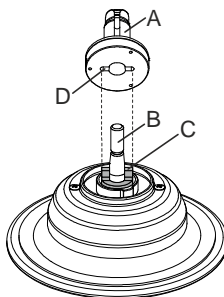

Montage du moyeu :

- Poser le moyeu (A) sur l'arbre moteur (B) à la verticale. L'entraîneur (C) sur l'arbre moteur doit se trouver dans la rainure (D) du moyeu.
- Avec la clé hexagonale fournie, serrer l'écrou du moyeu en tournant dans le sens des aiguilles d'une montre.
- Vérifier si le moyeu est bien fixé.

Démontage du moyeu :

- Sortir le rotor.
- Desserrer l'écrou du moyeu en tournant dans le sens inverse des aiguilles d'une montre, et tourner jusqu'au point de pression pour le retrait. Après avoir franchi ce point de pression, le moyeu se détache du cône de l'arbre moteur.
- Tourner l'écrou jusqu'à pouvoir soulever le moyeu de l'arbre moteur.

11.2.2 Insérer et retirer le rotor

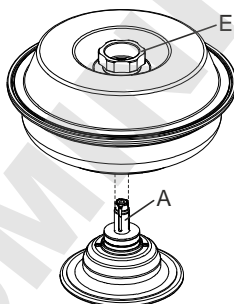

Insérer le rotor :

 La présence d'impuretés entre le moyeu et le rotor empêche au rotor d'avoir une position parfaite, et provoque un fonctionnement irrégulier du rotor. Si besoin est, nettoyer le moyeu (A) sur l'arbre moteur et le moyeu du rotor avant d'insérer le rotor.

- Soulever le rotor sur la poignée rotative (E) du couvercle, le poser à l'horizontale sur le moyeu (A) et appuyer dessous jusqu'à la butée.

Retirer le rotor :

- Tenir le rotor à la poignée rotative (E) du couvercle et l'ôter du moyeu (A).

12 Insérer et retirer les suspensions dans le rotor

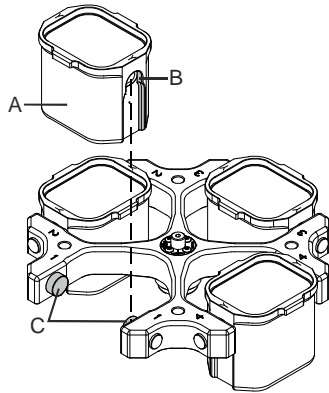

En cas de rotors à oscillation, chaque emplacement du rotor doit être occupé avec les **mêmes** suspensions.



Certaines suspensions sont identifiées par le numéro de l'emplacement du rotor. Ces suspensions ne peuvent être utilisées qu'à l'emplacement correspondant du rotor.

Les suspensions pourvues d'un numéro de jeu, S001/4 par ex., ne peuvent être utilisées qu'avec le jeu.

Insérer les suspensions dans le rotor :

- Vérifier si le rotor se trouve dans une position fixe.
- Graisser les tourillons (C) (graisse Hettich n° 4051).
- Insérer les suspensions (A) dans le rotor. Pour ce faire, veiller à ce que les tourillons (C) se trouvent dans les rainures (B) des suspensions.
- Enfoncer les suspensions jusqu'à la butée.

Retirer les suspensions du rotor :

- Retirer les suspensions (A) du rotor à la verticale.

13 Insérer et retirer les adaptateurs dans les suspensions

Insérer les adaptateurs dans les suspensions :

- Insérer les adaptateurs (A) à l'horizontale dans les suspensions (B).

Retirer les adaptateurs des suspensions :

- Retirer les adaptateurs (A) des suspensions (B) en les tirant vers le haut.

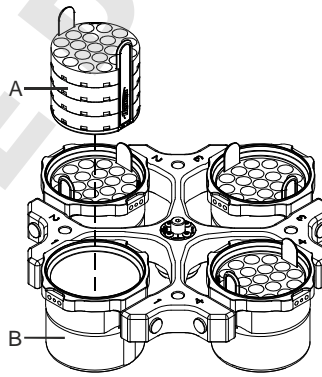
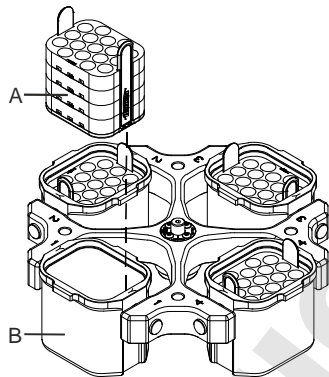

14 Poser dans le balancier l'adaptateur avec tenon de positionnement

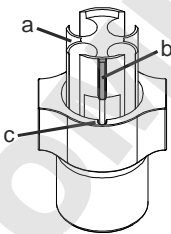

- Placer l'adaptateur (a) dans le balancier de sorte que la tenon de positionnement (b) se trouve dans la rainure (c) du balancier.



Le fait de ne pas placer correctement l'adaptateur (a) peut endommager les réservoirs de centrifugation durant le cycle de centrifugation.

15 Chargement du rotor

 Des récipients standard de centrifugation en verre sont résistants jusqu' à un ACR de 4000 (DIN 58970, partie 2).

- Vérifier la stabilité d'assise du rotor.
- Dans le cas des rotors à balanciers, toutes les positions des rotors doivent être équipées avec les **mêmes** balanciers. Certains balanciers sont désignés avec le numéro de la place du rotor. Ces balanciers doivent exclusivement être installés dans la place de rotor correspondante. Les balanciers désignés par un numéro de set, comme S001/4 par exemple, doivent exclusivement être utilisés dans le set.
- Le chargement des rotors et des balanciers doit être nécessairement symétrique. Les conteneurs de centrifugation doivent être uniformément répartis sur toutes les positions du rotor. Pour les combinaisons possibles, voir le Chapitre "Anhang/Appendix, Rotoren und Zubehör/Rotors and accessories". Dans le cas des rotors à angle fixe, il faut charger tous les logements possibles du rotor, voir au chapitre "Annexe/Appendix, Rotors et accessoires/Rotors and accessories".

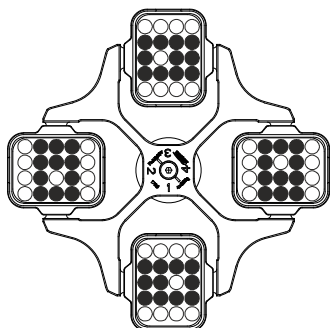

Le rotor est chargé de manière symétrique

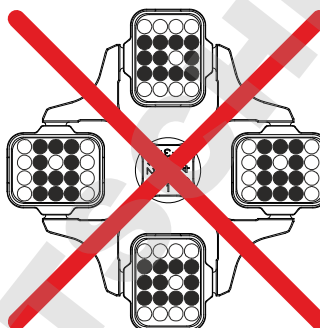

Non autorisé !
Le rotor n'est pas chargé de manière symétrique

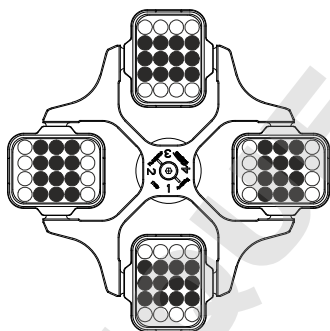

Rotor uniformément chargé

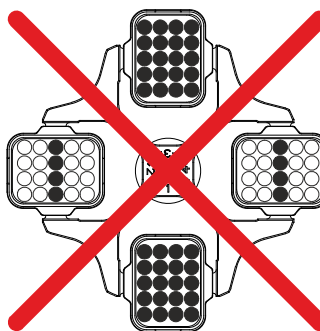

Non autorisé !
Rotor irrégulièrement chargé

- Certains dispositifs de suspension indiquent soit le poids maximum de la charge, soit le poids total maximum comprenant charge et dispositifs. Pour les cas d'exception, voir le chapitre "Centrifugation de matières et de mélanges d'une densité supérieure à 1,2 kg/dm³". L'indication du poids de la charge maximale comprend le poids total de l'adaptateur, du réservoir de centrifugation et du contenu.
- Dans le cas des récipients à garniture de caoutchouc, les récipients de centrifugation doivent avoir le même nombre de garnitures dans la partie inférieure.
- Remplissez les réservoirs de centrifugation uniquement en dehors de la centrifugeuse.

- La quantité maximale de remplissage indiquée par le fabricant pour les récipients de centrifugation ne doit pas être dépassée.

Pour les rotors angulaires, remplir les réservoirs de centrifugation de sorte que du liquide ne puisse pas être projeté à l'extérieur pendant le cycle de centrifugation

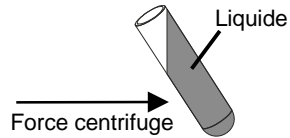

- Aucun fluide ne doit pénétrer dans les rotors angulaires et dans la cuve de centrifugeuse lors du chargement des rotors angulaires.
- Pendant le chargement de la suspension des balanciers, et pendant le balancement de la suspension dans le cycle de centrifugation, aucun fluide ne doit pénétrer dans la cuve de centrifugeuse.
- La hauteur de remplissage des récipients sera autant que possible égale pour maintenir les différences de poids entre les récipients de centrifugation aussi réduites que possible.

16 Fermeture des systèmes de sécurité biologique



Pour garantir l'étanchéité, le couvercle d'un système de sécurité biologique doit être solidement fermé.

Pour éviter de fausser la bague d'étanchéité en ouvrant et en fermant le couvercle, il faut frotter légèrement la bague d'étanchéité avec un produit d'entretien pour caoutchouc.

Lorsque la suspension d'un système de sécurité biologique est utilisée sans couvercle, il faut enlever la bague d'étanchéité de la suspension pour éviter de l'endommager pendant le cycle de centrifugation. Les bagues endommagées ne doivent plus être utilisées pour assurer l'étanchéité le système de sécurité biologique.

Pour ce qui concerne les systèmes à sécurité biologique, voir le chapitre "Anhang/Appendix, Rotoren und Zubehör/Rotors and accessories". Dans le doute vous pouvez obtenir les informations auprès du fabricant.

Couvercle avec fermeture à vis

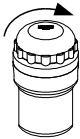

- Placer le couvercle sur le balancier.
- Bien fermer le couvercle en le tournant à la main dans le sens des aiguilles d'une montre.

17 Organes de commande et indicateurs

Voir illustration sur la page 2.

Fig. 2: Console des indicateurs et organes de commande

17.1 Symboles du tableau de commande



Affichage de la rotation. L'affichage de la rotation s'allume en tournant dans le sens inverse des aiguilles d'une montre, tant que le rotor tourne.

L'état du couvercle est indiqué grâce aux symboles dans l'affichage de la rotation pendant l'immobilisation du rotor :

Symbole : couvercle ouvert

Symbole : couvercle fermé

Les erreurs de commande et les dérangements qui surviennent sont indiqués à l'écran (voir au chapitre "Défauts").

17.2 Touches et possibilités de réglage

RPM/RCF x 100



- Vitesse de rotation

La valeur numérique pouvant être réglée va de 500 RPM à la vitesse de rotation maximale du rotor. Pour la vitesse de rotation maximale du rotor, voir au chapitre "Annexe/Appendix, Rotors et accessoires/Rotors and accessories". Réglage par pas de 100 (RPM = valeur indiquée x 100).

Lorsque vous maintenez enfoncée la touche ou , la valeur change de plus en plus rapidement.

- Afficher le niveau de freinage et le rayon de centrifugation.

t



- Temps de marche

- Réglage de 1 à 99 minutes, par pas de 1 minute

- Fonctionnement continu "--"

- Rayon de centrifugation. Saisie en centimètres. Réglage de 5 à 16 centimètres, par pas de 1 centimètre. Pour le rayon de centrifugation, voir au chapitre "Annexe/Appendix, Rotors et accessoires/Rotors and accessories".

- Niveau de freinage 0 ou 1. Niveau 1 = temps de ralentissement court, niveau 0 = temps de ralentissement long.

Lorsque vous maintenez enfoncée la touche ou , la valeur change de plus en plus rapidement.



- Démarrer le cycle de centrifugation.



- Terminer le cycle de centrifugation.
Le rotor ralentit avec le niveau de freinage présélectionné.
- Sauvegarder le niveau de freinage et le rayon de centrifugation.



- Affichage de l'accélération centrifuge relative (RCF).
L'accélération centrifuge relative (RCF) est indiquée tant que la touche est maintenue enfoncée.



- Centrifugation de courte durée.
Le cycle de centrifugation a lieu tant que la touche est maintenue enfoncée.
- Afficher le niveau de freinage et le rayon de centrifugation.

18 Régler le niveau de freinage

- Couper l'interrupteur de secteur.
- Appuyer simultanément sur la touche ▲ située en dessous de l'affichage de la vitesse de rotation et sur la touche (IMPULS).
- Fermer l'interrupteur de secteur et relâcher les touches.

La version de la machine est indiquée dans l'affichage de la vitesse de rotation et le niveau de freinage réglé dans l'affichage du temps, par ex.:

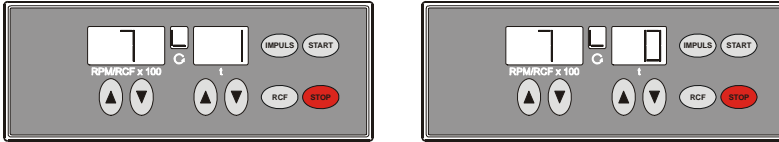

Si la version de la machine et le niveau de freinage ne s'affichent pas, appuyer ensuite sur la touche ▲ située sous l'affichage de la vitesse de rotation jusqu'à ce qu'ils apparaissent.

La version de la machine est réglée à l'usine et ne peut pas être modifiée.

- Régler le niveau de freinage souhaité avec les touches ▲ ▼ situées en dessous de l'affichage du temps. Niveau 1 = temps de ralentissement court, niveau 0 = temps de ralentissement long. Pour les temps de ralentissement, voir au chapitre "Anhang/Appendix, Rotoren und Zubehör/Rotors and accessories".
- Appuyer sur la touche (STOP) pour sauvegarder le réglage.

19 Régler le rayon de centrifugation



Le rayon de centrifugation doit être saisi en centimètres.

- Couper l'interrupteur de secteur.
- Appuyer simultanément sur la touche ▲ située en dessous de l'affichage de la vitesse de rotation et sur la touche (IMPULS).
- Fermer l'interrupteur de secteur et relâcher les touches.
- Appuyer sur la touche ▲ située en dessous de l'affichage de la vitesse de rotation, jusqu'à ce que l'affichage suivant apparaisse :

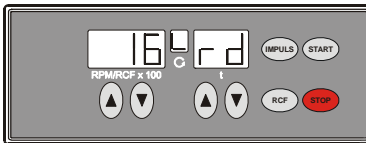

Le rayon de centrifugation est indiqué dans l'affichage de la vitesse de rotation.

- Régler le rayon de centrifugation souhaité avec les touches ▲ ▼ situées en dessous de l'affichage du temps. Pour le rayon de centrifugation, voir au chapitre "Anhang/Appendix, Rotoren und Zubehör/Rotors and accessories".
- Appuyer sur la touche (STOP) pour sauvegarder le réglage.

20 Centrifugation

 Durant un processus de centrifugation, aucune personne, matière dangereuse et aucun objet ne doivent se trouver dans une zone de sécurité de 300 mm autour de la centrifugeuse selon EN / IEC 61010-2-020.

 Si la différence de poids admissible est dépassée pendant le chargement du rotor, l'entraînement s'arrête pendant le démarrage et l'erreur **-3-** s'affiche (voir au chapitre "Défauts").
Un cycle de centrifugation peut être interrompu à tout moment en appuyant sur la touche **[STOP]**.
Le temps et la vitesse peuvent être modifiés pendant le cycle de centrifugation avec les touches **[▲]** **[▼]**.
Lorsque vous maintenez enfoncée la touche **[▲]** ou **[▼]**, la valeur change de plus en plus rapidement.
L'affichage clignote après un cycle de centrifugation jusqu'à l'ouverture du couvercle ou l'appui d'une touche.
Lorsque le symbole "—" (couvercle fermé) et "L" (couvercle ouvert) clignote à tour de rôle dans l'affichage de la rotation **⊙**, il est alors seulement possible d'exécuter une nouvelle commande de la centrifugeuse après une ouverture du couvercle.
Lorsque **rot xx** s'affiche, c'est qu'aucun cycle de centrifugation n'a eu lieu, car le rotor a été auparavant changé, voir au chapitre "Identification de rotor".

- Fermer l'interrupteur de secteur (position de l'interrupteur "I").
- Charger le rotor et fermer le couvercle de la centrifugeuse.

20.1 Centrifugation après présélection du temps

- Régler la vitesse de rotation souhaitée avec les touches **[▲]** **[▼]** situées en dessous de l'affichage de la vitesse de rotation.
- Régler le temps souhaité avec les touches **[▲]** **[▼]** situées en dessous de l'affichage du temps.
- Appuyer sur la touche **[START]**. La rotation **⊙** est indiquée tant que le rotor fonctionne.

 Le temps est indiqué en minutes. La dernière minute est décomptée en secondes.
Lorsque le temps est indiqué en minutes, un point clignote à côté du chiffre.

- Après l'expiration du temps ou l'interruption du cycle de centrifugation en appuyant sur la touche **[STOP]**, le ralentissement du rotor a lieu avec le niveau de freinage réglé.

La vitesse de rotation du rotor ou la valeur RCF en résultant et le temps qui reste s'affichent pendant le cycle de centrifugation.

20.2 Fonctionnement continu

- Régler la vitesse de rotation souhaitée avec les touches **[▲]** **[▼]** situées en dessous de l'affichage de la vitesse de rotation.
- Mettre le temps à zéro avec la touche **[▼]** située en dessous de l'affichage du temps. "--" s'affiche.
- Appuyer sur la touche **[START]**. La rotation **⊙** est indiquée tant que le rotor fonctionne. Le chronométrage commence à 0.

 La première minute est comptée en secondes, le temps s'affiche ensuite en minutes.
Lorsque le temps est indiqué en minutes, un point clignote à côté du chiffre.

- Appuyer sur la touche **[STOP]** pour terminer le cycle de centrifugation. Le ralentissement du rotor a lieu avec le niveau de freinage réglé.

La vitesse de rotation du rotor ou la valeur RCF en résultant et le temps écoulé s'affichent pendant le cycle de centrifugation.

20.3 Centrifugation de courte durée

- Régler la vitesse de rotation souhaitée avec les touches **[▲]** **[▼]** situées en dessous de l'affichage de la vitesse de rotation.
- Maintenir enfoncée la touche **[IMPULS]**. La rotation **⊙** est indiquée tant que le rotor fonctionne. Le chronométrage commence à 0.

 La première minute est comptée en secondes, le temps s'affiche ensuite en minutes.
Lorsque le temps est indiqué en minutes, un point clignote à côté du chiffre.

- Relâcher la touche **[IMPULS]** pour terminer le cycle de centrifugation. Le ralentissement du rotor a lieu avec le niveau de freinage réglé.

La vitesse de rotation du rotor et le temps écoulé s'affichent pendant le cycle de centrifugation.

20.4 Affichage de l'accélération centrifuge relative (RCF)

L'accélération centrifuge relative (RCF) peut être indiquée pendant le cycle de centrifugation.



Lorsque vous travaillez avec l'accélération centrifuge relative (RCF), il faut saisir le rayon de centrifugation.

- Maintenir enfoncée la touche **[RCF]** pendant le cycle de centrifugation. L'accélération centrifuge relative (RCF) apparaît dans l'affichage de la vitesse de rotation (RCF = valeur indiquée x 100).
- Relâcher la touche **[RCF]**. La vitesse de rotation est à nouveau indiquée.

21 Signal acoustique

Le signal sonore retentit:

- en cas d'apparition d'un défaut à un intervalle de 2 s.
- au terme de la centrifugation et après immobilisation du rotor, à un intervalle de 30 s.

Le signal sonore cesse après ouverture du couvercle, en appuyant sur une touche quelconque.

Lorsque le rotor est à l'arrêt, le signal sonore peut être activé ou désactivé de la manière suivante :

- Couper l'interrupteur de secteur.
- Appuyer simultanément sur la touche **[▲]** située en dessous de l'affichage de la vitesse de rotation et sur la touche **[IMPULS]**.
- Fermer l'interrupteur de secteur et relâcher les touches.
- Appuyer sur la touche **[▲]** située en dessous de l'affichage de la vitesse de rotation, jusqu'à ce que l'affichage suivant apparaisse :

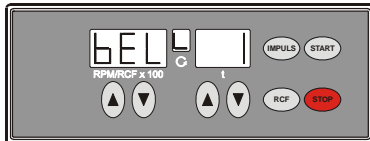

Dans l'affichage temps, on peut voir le réglage du signal acoustique.

0 = signal acoustique désactivé, 1 = signal acoustique activé.

- Avec les touches **[▲]** **[▼]** ajuster 0 ou 1 sous l'affichage temps.
- Appuyer sur la touche **[STOP]** pour sauvegarder le réglage.

22 Accélération centrifuge relative (RCF)

L'accélération centrifuge relative (RCF) est indiqué en tant que multiple de l'accélération gravitationnelle (g). Il s'agit d'une valeur dépourvue d'unité, qui sert à la comparaison entre la puissance de séparation et de sédimentation.

Le calcul s'effectue à l'aide de la formule suivante:

$$RCF = \left(\frac{RPM}{1000} \right)^2 \times r \times 1,118 \quad \Rightarrow \quad RPM = \sqrt{\frac{RCF}{r \times 1,118}} \times 1000$$

RCF = accélération centrifuge relative

RPM = régime

r = rayon de centrifugation en mm = distance qui sépare le centre de l'axe de rotation du fond de la cuve de centrifugation. Rayon de centrifugation voir chapitre "Anhang/Appendix, Rotoren und Zubehör/Rotors and accessories".



L'accélération centrifuge relative (RCF) est dépendante du régime et du rayon de centrifugation.

23 Centrifugation de matières et de mélanges d'une densité supérieure à 1,2 kg/dm³

Dans le cas de la centrifugation à la vitesse maximale, la densité des substances et des mélanges de substances ne doit pas excéder 1,2 kg/dm³. Réduire la vitesse de rotation pour les matières et mélanges ayant une densité supérieure.

La vitesse de rotation autorisée se calcule de la manière suivante:

$$\text{Vitesse de centrifugation lente (n}_{\text{red}}) = \sqrt{\frac{1,2}{\text{densité supérieure [kg/dm}^3]}} \times \text{Vitesse de rotation maximum [RPM]}$$

Exemple: Vitesse de rotation maximum RPM 4000, densité 1,6 kg/dm³

$$n_{\text{red}} = \sqrt{\frac{1,2 \text{ kg/dm}^3}{1,6 \text{ kg/dm}^3}} \times 4000 \text{ RPM} = 3464 \text{ RPM}$$

Dans le cas exceptionnel de dépassement de la charge maximum indiquée sur la suspension, réduire également la vitesse de rotation.

La vitesse de rotation autorisée se calcule de la manière suivante:

$$\text{Vitesse de centrifugation lente (n}_{\text{red}}) = \sqrt{\frac{\text{Charge maximum [g]}}{\text{Charge réelle [g]}}} \times \text{Vitesse de rotation maximum [RPM]}$$

Exemple: Vitesse de rotation maximum RPM 4000, Charge maximum 300 g, Charge réelle 350 g

$$n_{\text{red}} = \sqrt{\frac{300 \text{ g}}{350 \text{ g}}} \times 4000 \text{ RPM} = 3703 \text{ RPM}$$

En cas d'incertitude, prendre contact avec le fabricant.

24 Identification du rotor

Une identification du rotor est effectuée après le démarrage de chaque cycle de centrifugation.

Si le rotor a été remplacé, le cycle de centrifugation s'interrompt après l'identification du rotor. L'afficheur indique le code (rot xx) du rotor.

- Appuyer sur la touche **(START)**. Les dernières données de centrifuge utilisées s'affichent.



Toute commande ultérieure de la centrifuge n'est possible qu'après une ouverture du couvercle.

Si la vitesse de rotation maximale du rotor utilisé est inférieure à la vitesse de rotation paramétrée, la vitesse de rotation effective est limitée à la vitesse de rotation maximale du rotor.

25 Déverrouillage d'urgence

En cas de panne de courant, le couvercle ne peut pas être ouvert. Il est nécessaire d'exécuter un déverrouillage manuel.



Avant d'exécuter le déverrouillage manuel, retirer la fiche de l'alimentation.

Attendre que le rotor est à l'arrêt pour ouvrir le couvercle.

Seule la tige de déverrouillage en plastique fournie peut être utilisée pour un déverrouillage d'urgence.

Voir illustration sur la page 2.

- Couper l'interrupteur de secteur (position de l'interrupteur "0").
- Regarder par la fenêtre située sur le couvercle pour s'assurer que le rotor est immobile.
- Introduire la goupille de déverrouillage horizontalement dans le forage (fig. 1, A). Enfoncez la tige de déverrouillage jusqu'à ce que vous puissiez faire pivoter la languette de saisie vers le haut lorsque vous poussez la tige vers le bas.
- Ouvrir le capot.

26 Entretien et maintenance



L'appareil est peut-être contaminé.



Retirer la prise de secteur avant de nettoyer.

Avant d'utiliser une procédure de nettoyage ou de décontamination autre que celle recommandée par le fabricant, l'utilisateur vérifiera auprès du fabricant que la procédure prévue n'endommage pas l'appareil.

- Ne pas nettoyer centrifuges, rotors et accessoires dans un lave-vaisselle.
- Seul le nettoyage manuel et une désinfection liquide sont autorisés.
- La température de l'eau doit être située entre 20 et 25°C.
- Utiliser exclusivement des agents de nettoyage ou de désinfection qui :
 - ont un pH de 5 à 8,
 - ne contiennent pas de substances caustiques, de peroxyde, composés chlorés, acides ni alcalins.
- Respecter impérativement les consignes spéciales d'utilisation données par le fabricant des agents de nettoyage et de désinfection, afin de prévenir la corrosion par les agents de nettoyage et de désinfection.

26.1 Centrifugeuse (boîtier, couvercle et cuve)

26.1.1 Entretien et nettoyage des surfaces

- Nettoyer régulièrement le boîtier de la centrifugeuse et le compartiment de centrifugation et les laver en cas de besoin avec du savon ou un détergent doux et un chiffon humide. Ces opérations sont nécessaires pour garantir l'hygiène et pour prévenir la corrosion par la présence durable d'impuretés.
- Substances des nettoyants adéquats :
savon, agents anioniques et non ioniques.
- Après utilisation des nettoyants, enlevez les résidus en essuyant l'appareil avec un chiffon humide.
- Séchez immédiatement les surfaces après nettoyage.
- Sécher le bol avec un chiffon absorbant en cas de dépôt d'eau de condensation dans le bol de la centrifugeuse.
- Frotter légèrement le joint d'étanchéité en caoutchouc du compartiment de centrifugation, après chaque nettoyage, avec un produit d'entretien pour caoutchouc.
- Vérifiez tous les ans le bon état de la cuve.



N'utilisez plus la centrifugeuse si elle présente des dommages susceptibles de porter atteinte à la sécurité. Auquel cas, contactez le service après-vente.

26.1.2 Désinfection des surfaces

- Le bol de la centrifugeuse doit être nettoyé immédiatement dans le cas où un matériau infectieux a pénétré dans le bol de la centrifugeuse.
- Substances des désinfectants adéquats :
éthanol, n-propanol, éthylènehexanol, agents anioniques, inhibiteurs de corrosion.
- Après utilisation de désinfectants, enlevez les résidus en essuyant l'appareil avec un chiffon humide.
- Séchez immédiatement les surfaces après désinfection.

26.1.3 Décontamination de substances radioactives

- L'agent employé doit expressément convenir pour une décontamination de substances radioactives.
- Substances des agents adaptés à une décontamination des substances radioactives :
agents anioniques, non ioniques agents, éthanol polyhydre.
- Après décontamination des substances radioactives, enlevez les résidus en essuyant l'appareil avec un chiffon humide.
- Séchez immédiatement les surfaces après décontamination des substances radioactives.

26.2 Rotors et accessoires

26.2.1 Nettoyage et entretien

- Afin de prévenir la corrosion et toute modification des matériaux, il faut nettoyer régulièrement les rotors et les accessoires avec du savon ou un détergent doux et un chiffon humide. Il est vivement recommandé d'effectuer un nettoyage au moins une fois par semaine. Enlevez immédiatement les impuretés.
- Substances des nettoyants adéquats :
savon, agents anioniques et non ioniques.
- Après utilisation de nettoyants, enlevez les résidus en rinçant à l'eau claire (uniquement à l'extérieur de la centrifugeuse) ou en essuyant les surfaces avec un chiffon humide.
- Séchez rotors et accessoires immédiatement après nettoyage.
- Après séchage, les rotors d'angle, les réservoirs et la suspension en aluminium seront enduits d'une pellicule de graisse sans acide, par exemple la vaseline.
- Nettoyer une fois par semaine les bagues d'étanchéité des systèmes de biosécurité.
Les bagues d'étanchéité sont fabriquées en silicone. Afin de garantir l'étanchéité des systèmes de biosécurité, ne pas traiter les bagues d'étanchéité, après leur nettoyage ou autoclave, avec du talc en poudre. Avant toute utilisation du système de biosécurité, vérifier par un contrôle visuel le bon état de chaque pièce du système de biosécurité. En outre, vérifier la position correcte de, ou des bagues d'étanchéité du système de biosécurité.
Remplacer sans plus attendre toute pièce défectueuse du système de biosécurité.
Remplacer immédiatement toute bague d'étanchéité présentant des signes de formation de fissure, de fragilisation ou d'usure. Remplacer tout le couvercle en cas de couvercle ayant des bagues d'étanchéité non remplaçables.
Vous trouverez au chapitre "Annexe/Appendix, rotors et accessoires/Rotors and accessories" la liste des systèmes de biosécurité pouvant être livrés.
- Déposer le rotor au moins une fois par mois, nettoyer et enduire l'arbre d'entraînement d'une pellicule de graisse pour prévenir la corrosion par la présence d'humidité entre le rotor et l'arbre d'entraînement.
- Vérifier une fois par semaine l'état des rotors et des accessoires afin de détecter les éventuelles détériorations issues de l'usure et l'oxydation.
Pour les rotors à oscillation, vérifier surtout la zone de portée des tourillons et pour les balanciers, vérifier les rainures et le fond pour détecter les éventuelles fissures.
Exemple : fissures dans la rainure.



 Les rotors et les accessoires usés et endommagés par la corrosion ne doivent plus être utilisés.

- Vérifier chaque semaine la stabilité de fixation du rotor.

26.2.2 Désinfection

- Si les rotors ou accessoires sont infectés, procédez à une désinfection appropriée.
- Substances des désinfectants adéquats :
éthanol, n-propanol, éthylènehexanol, agents anioniques, inhibiteurs de corrosion.
- Après utilisation de désinfectants, enlevez les résidus en rinçant à l'eau claire (uniquement à l'extérieur de la centrifugeuse) ou en essuyant les surfaces avec un chiffon humide.
- Séchez rotors et accessoires immédiatement après désinfection.

26.2.3 Décontamination de substances radioactives

- L'agent employé doit expressément convenir pour une décontamination de substances radioactives.
- Substances des agents adaptés à une décontamination des substances radioactives : agents anioniques, agents non ioniques, éthanol polyhydre.
- Après décontamination des substances radioactives, enlevez les résidus en rinçant à l'eau claire (uniquement à l'extérieur de la centrifugeuse) ou en essuyant les surfaces avec un chiffon humide.
- Séchez immédiatement rotors et accessoire après décontamination des substances radioactives.

26.2.4 Goupilles de fixation

Les goupilles de fixation des rotors à amortissement doivent être graissées régulièrement (graisse de lubrification Hettich n° 4051) de manière à assurer le balancement régulier de la suspension.

26.2.5 Rotors et accessoires à durée d'utilisation limitée

L'utilisation de certains rotors, balanciers et accessoires est limitée dans le temps.

Ces limites sont indiquées par le nombre maximum de cycles ou la date limite d'utilisation et le nombre maximum de cycles, ou simplement la date limite d'utilisation, par ex. :

- "einsetzbar bis Ende: IV. Quartal 2011 / usable until end of: IV. trimestre 2011" (utilisation autorisée jusqu'à fin: IV. trimestre 2011) ou "einsetzbar bis Ende Monat/Jahr: 10/2011 / usable until end of month/year: 10/2011" (utilisation autorisée jusqu'à fin mois/an : 10/2011)
- "max. Laufzyklen / max. cycles: 40000" (nombre ma. de cycles 40000)



Pour des raisons de sécurité, l'utilisation de rotors, balanciers et accessoires n'est plus autorisée dès que le nombre maximum de cycles désigné ou la date limite d'utilisation inscrite sont atteints.

26.3 Autoclave

Vous pouvez stériliser par autoclave à 121°C / 250°F (20 min) les accessoires suivants:

- rotors à oscillation
- rotors angulaires en aluminium
- balancier en métal
- couvercle avec bio-étanchéité
- adaptateur

Nous ne pouvons faire aucune déclaration sur le degré de stérilisation.



Avant autoclave, retirez les couvercles des rotors et réservoirs.

La stérilisation en autoclave accélère le processus de vieillissement des matières plastiques. Elle peut également modifier la couleur des plastiques.

Après autoclave, vérifiez si les rotors et accessoires sont en bon état (contrôle visuel), remplacer immédiatement toute pièce éventuellement défectueuse.

Remplacer immédiatement toute bague d'étanchéité présentant des signes de formation de fissure, de fragilisation ou d'usure.

Remplacer tout le couvercle en cas de couvercle ayant des bagues d'étanchéité non remplaçables.

Afin de garantir l'étanchéité des systèmes de biosécurité, ne pas traiter les bagues d'étanchéité, après autoclave, avec du talc en poudre.

26.4 Réservoirs de centrifugation

- En cas de fuite ou de rupture de récipients de centrifugation, il faut éliminer tous les morceaux de récipients cassés, les fragments de verre et les substances centrifugées écoulées.
- Les amortisseurs antivibrations ainsi que les caoutchouc intermédiaires des rotors doivent être remplacés après un bris de verre.



Les fragments de verre restants peuvent entraîner d'autres bris de verre !

- S'il s'agit d'un matériau infectieux, exécuter immédiatement une désinfection.

27 Défauts

Si l'erreur ne peut pas être éliminée d'après le tableau des défauts, il faut alors avertir le service après-vente.

Veuillez indiquer le type de centrifuge et le numéro de série. Les deux numéros sont indiqués sur la plaque signalétique de la centrifugeuse.

	<p>Effectuer une RÉINITIALISATION DU SECTEUR :</p> <ul style="list-style-type: none"> - Couper l'interrupteur de secteur (position de l'interrupteur "0"). - Attendre au moins 10 secondes et refermer ensuite l'interrupteur de secteur (position de l'interrupteur "1").
---	--

Erreur	Affichage	Cause	Solution
Pas d'affichage	---	Pas de tension Défaut des fusibles sur l'entrée de secteur.	<ul style="list-style-type: none"> - Vérifier l'alimentation en tension. - Vérifier les fusibles d'entrée du secteur, voir au chapitre "Changer les fusibles d'entrée de secteur". - Interrupteur du secteur sur MARCHE
Erreur du compteur de vitesse	- 1 -	Défaillance des impulsions de rotation pendant une opération.	<ul style="list-style-type: none"> - On ne doit pas arrêter l'appareil tant que l'indicateur de rotation  est allumé et tourne en même temps. Attendre jusqu'à ce que l'icône "—" (couvercle fermé) apparaisse sur l'indicateur de rotation (après env. 100 secondes), puis effectuer une RÉINITIALISATION SECTEUR.
Reset secteur	- 2 -	Interruption du secteur pendant le cycle de centrifugation. (Le cycle de centrifugation n'est pas terminé.)	<ul style="list-style-type: none"> - Après l'arrêt, ouvrir le couvercle et actionner touche (START). - En cas de besoin, répéter le cycle de centrifugation.
Défaut d'équilibrage	- 3 -	Le rotor est chargé de manière non symétrique.	<ul style="list-style-type: none"> - Après arrêt du rotor, ouvrir le couvercle. - Vérifier le chargement du rotor, voir au chapitre "Chargement du rotor". - Répéter le cycle de centrifugation.
Communication	- 4 -	Défaut dans l'unité de commande ou capacité.	<ul style="list-style-type: none"> - Effectuer une RÉINITIALISATION DU SECTEUR après l'immobilisation du rotor.
Surcharge	- 5 -	Moteur ou commande du moteur défectueux.	<ul style="list-style-type: none"> - Effectuer une RÉINITIALISATION DU SECTEUR après l'immobilisation du rotor.
Sur tension ou sous-tension	- 6 - - 8 -	Tension du secteur en dehors des tolérances (voir : Caractéristiques techniques).	<ul style="list-style-type: none"> - Effectuer une RÉINITIALISATION DU SECTEUR après l'immobilisation du rotor. - Vérifier tension du secteur.
Survitesse	- 7 -	Défaut dans l'unité de capacité.	<ul style="list-style-type: none"> - Effectuer une RÉINITIALISATION DU SECTEUR après l'immobilisation du rotor.
Surtempérature	- 9 -	Avertisseur de surtempérature dans le moteur a déclenché.	<ul style="list-style-type: none"> - Après arrêt du rotor, ouvrir le couvercle à l'aide du déverrouillage de secours. (Voir chapitre : Déverrouillage de secours). - Laisser refroidir le moteur.
Versions Error	Un chiffre apparaît dans l'affichage du temps.	Une version erronée de la machine a été introduite. Unité de commande saute au menu ajustage.	<ul style="list-style-type: none"> - Régler le chiffre 4 avec les touches   situées en dessous de l'affichage du temps. - Appuyer sur la touche (STOP) pour sauvegarder le réglage. - Effectuer une RÉINITIALISATION DU SECTEUR.
Controller-Watchdog	- C -	Défaut dans l'unité de commande.	<ul style="list-style-type: none"> - Effectuer une RÉINITIALISATION DU SECTEUR après l'immobilisation du rotor.
Erreur du verrouillage du couvercle	d	Erreur du verrouillage ou de la fermeture du capot.	<ul style="list-style-type: none"> - Effectuer une RÉINITIALISATION DU SECTEUR après l'immobilisation du rotor.
Court-circuit	- E -	Court-circuit dans l'unité de commande / capacité.	<ul style="list-style-type: none"> - Effectuer une RÉINITIALISATION DU SECTEUR après l'immobilisation du rotor.
Pas de code du rotor	- F -	Pas de reconnaissance du rotor au démarrage. Pas de rotor en service ou compteur de vitesse défectueux.	<ul style="list-style-type: none"> - Effectuer une RÉINITIALISATION DU SECTEUR après l'immobilisation du rotor.
Le nouveau rotor est reconnu	rot...	Voir chapitre détection du rotor	<ul style="list-style-type: none"> - Appuyer sur la touche (START).

28 Changer les fusibles d'entrée de secteur



Déclencher l'interrupteur de secteur et couper l'appareil du réseau!

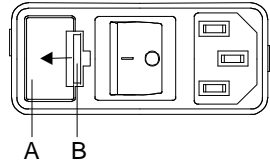

Le porte-fusible (A) avec les fusibles d'entrée de secteur se trouve à côté de l'interrupteur secteur.

- Retirer le câble de raccordement de la prise d'appareil.
- Appuyer la fermeture rapide (B) contre le porte-fusible (A) et extraire celui-ci.
- Remplacer les fusibles d'entrée du réseau défectueux.



N'utilisez que des fusibles avec la valeur nominale, fixée pour le type, voir tableau suivant.

- Remettre en place le porte-fusible et pousser jusqu'à encastrement de la fermeture rapide.
- Rebrancher l'appareil sur le réseau.

Modèle	Type	Fusible	N° de commande
ROTOFIX 32 A	1206, 1206-34	T 3.15 AH/250V	E997
ROTOFIX 32 A	1206-01, 1206-33	T 5 AH/250V	E914

29 Renvoi d'appareils au fabricant



Avant de renvoyer l'appareil, il faut monter le dispositif de fixation pour le transport.

Dans le cas où l'appareil ou ses accessoires doivent être retournés à la société Andreas Hettich GmbH & Co. KG, il faut les décontaminer et les nettoyer avant expédition, dans le but d'assurer la protection des personnes, de l'environnement et du matériel.

Nous nous réservons le droit de refuser des appareils ou des accessoires contaminés.

Nous facturons au client les frais de nettoyage et de désinfection.

Vous voudrez bien manifester votre compréhension pour cette réglementation.

30 Élimination des déchets

Avant de mettre l'appareil au rebut, vous devez le décontaminer et le nettoyer pour la protection des personnes, de l'environnement et du matériel.

Les dispositions légales en vigueur doivent être respectées lors de l'élimination de l'appareil.

Conformément à la directive 2002/96/CE (WEEE), tous les appareils livrés après le 13.08.2005 ne doivent plus être jetés avec les déchets ménagers. L'appareil fait partie du groupe 8 (dispositifs médicaux) et est classé dans le domaine "Business-to-Business".



Le symbole de la poubelle barrée d'une croix indique que l'appareil ne doit pas être jeté avec les déchets ménagers.

Les dispositions relatives à l'élimination des déchets des différents pays de l'UE peuvent varier. Veuillez-vous adresser en cas de besoin à votre fournisseur.

Indice

1	Usò previsto.....	77
2	Rischi residui	77
3	Dati tecnici	77
4	Indicazioni inerenti la sicurezza	78
5	Significato dei simboli	80
6	Contenuto della fornitura.....	81
7	Disimballo della centrifuga.....	81
8	Trasporto ed immagazzinaggio.....	81
8.1	Trasporto	81
8.2	Immagazzinaggio	81
9	Messa in funzione.....	82
10	Apertura e chiusura del coperchio.....	82
10.1	Apertura del coperchio.....	82
10.2	Chiusura del coperchio	82
11	Montaggio e smontaggio del rotore	83
11.1	Rotore con dado di bloccaggio.....	83
11.2	Rotore senza dado di bloccaggio.....	83
11.2.1	Montaggio e smontaggio del mozzo	83
11.2.2	Installazione ed estrazione del rotore	83
12	Applicare ed estrarre i ganci dal rotore.....	84
13	Applicare ed estrarre dai ganci l'adattatore	84
14	Applicare nel gancio l'adattatore con il perno di posizionamento	84
15	Carico del rotore.....	85
16	Chiudere i sistemi biologici di sicurezza	86
17	Elementi di operazione e visualizzazione	87
17.1	Simboli del quadro comandi.....	87
17.2	Pulsanti e possibilità di regolazione	87
18	Regolazione del livello di frenatura.....	88
19	Regolazione del raggio di centrifugazione.....	88
20	Centrifugazione	89
20.1	Centrifugazione con preselezione del tempo	89
20.2	Funzionamento continuo.....	89
20.3	Centrifugazione a impulsi.....	89
20.4	Visualizzazione dell'accelerazione centrifuga relativa (RCF).....	90
21	Segnale acustico	90
22	Accelerazione centrifuga relativa (RCF).....	90
23	Centrifugazione di sostanze o di miscele di sostanze con densità maggiore di 1,2 kg/dm ³	91
24	Riconoscimento del rotore.....	91
25	Sblocco di emergenza.....	91
26	Pulizia e manutenzione	92
26.1	Centrifughe (scatola, coperchio e vano di centrifugazione).....	92
26.1.1	Cura e pulizia delle superfici	92
26.1.2	Disinfezione delle superfici	92
26.1.3	Rimuovere contaminazioni radioattive	92

26.2	Rotori ed accessori	93
26.2.1	Pulizia e cura	93
26.2.2	Disinfezione	93
26.2.3	Rimuovere contaminazioni radioattive	94
26.2.4	Perni di trascinamento	94
26.2.5	Rotori ed accessori con limitata durata di impiego.....	94
26.3	Trattamento in autoclave	94
26.4	Contenitori centrifuga.....	94
27	Guasti.....	95
28	Sostituzione fusibili entrata rete	96
29	Rispedizione di apparecchi	96
30	Smaltimento	96
31	Anhang / Appendix.....	97
31.1	Rotoren und Zubehör / Rotors and accessories.....	97

1 Uso previsto

Per quanto riguarda l'apparecchio in oggetto, si tratta di un prodotto medico (centrifuga di laboratorio) ai sensi della direttiva Diagnostici in vitro (IVD) 98/79/CE.

La centrifuga è stata concepita per separare materiali o miscele di materiali che hanno una densità massima di 1,2 kg/dm³. Fanno parte in particolare di questa classificazione i campioni per le preparazioni a scopi diagnostici In-vitro nella medicina umana.

Le centrifuga è destinata solo a questo scopo d'impiego.

Un diverso od ulteriore tipo di impiego non è regolamentare. La ditta Andreas Hettich GmbH & Co. KG non si prende carico di alcuna responsabilità nel caso di danni da ciò derivanti.

Per l'impiego a norma è previsto anche il rispetto di tutte le avvertenze riportate nelle istruzioni d'uso ed il rispetto degli interventi di ispezione e di manutenzione.

2 Rischi residui

L'apparecchio è costruito secondo lo stato attuale della tecnica e le regole riconosciute riguardanti la tecnica della sicurezza. In caso di uso ed impiego non regolamentari possono insorgere pericoli mortali per l'utilizzatore o per terzi risp. danni all'apparecchio o ad altri beni materiali. L'apparecchio è destinato solo all'uso regolamentare e va utilizzato solo in uno stato perfetto per quanto riguarda la tecnica della sicurezza.

Eventuali anomalie, che possono pregiudicare la sicurezza devono essere immediatamente eliminate.

3 Dati tecnici

Costruttore	Andreas Hettich GmbH & Co. KG D-78532 Tuttlingen	
Modello	ROTOFIX 32 A	
Tipo	1206 1206-34	1206-01 1206-33
Tensione di rete ($\pm 10\%$)	208 – 240 V 1~	100 – 127 V 1~
Frequenza di rete	50 – 60 Hz	50 – 60 Hz
Potenza assorbita	300 VA	300 VA
Assorbimento di corrente	1.4 A	3.0 A
Capacità max.	4 x 100 ml / 32 x 15 ml	
Densità permessa	1.2 kg/dm ³	
Regime di rotazione (RPM)	6000	
Accelerazione (RCF)	4226	
Energia cinetica	3160 Nm	
Obbligo di collaudo (DGUV Regel 100 – 500)	no	
Presupposti ambientali (EN / IEC 61010-1)	<p>solo in interni fino a 2000 metri sopra il livello del mare 2°C fino a 40°C umidità relativa massima dell'aria 80% per temperature fino a 31°C, con riduzione lineare fino al 50% dell'umidità relativa per una temperatura di 40°C.</p>	
– luogo di installazione		
– altezza		
– temperatura ambiente		
– umidità dell'aria		
– Categoria di sovratensione (IEC 60364-4-443)	II	
– grado di imbrattamento	2	
Classe di protezione	I	
non adatto per l'impiego in ambiente a rischio di esplosione.		
Compatibilità elettromagnetica	EN / IEC 61326-1, classe B	
– emissione di radiointerferenze, resistenza alle interferenze	FCC Class B	
Livello di emissione acustica (in funzione del rotore)	≤ 57 dB(A)	
dimensioni		
– larghezza	366 mm	
– profondità	430 mm	
– altezza	257 mm	
Peso	23 kg	

4 Indicazioni inerenti la sicurezza



Se non vengono rispettate tutte le avvertenze riportate in queste istruzioni per il funzionamento, non può essere accettata da parte del costruttore alcuna richiesta di garanzia.



- **La centrifuga deve venire posizionata in modo sicuro.**
- **Prima di utilizzare la centrifuga, è necessario controllare che il rotore sia correttamente in sede.**
- **Durante un'operazione di centrifugazione, in una zona di sicurezza di 300 mm attorno alla centrifuga non deve sostare alcuna persona, materiali pericolosi ed oggetti, in conformità alle norme EN / IEC 61010-2-020.**
- **I rotori, le sospensioni e gli accessori che presentano forti segni di corrosione o danni meccanici, oppure la cui durata d'impiego è scaduta, non devono più essere utilizzati.**
- **Se il vano di centrifugazione presenta danni rilevanti per la sicurezza, la centrifuga non deve essere più messa in funzione.**
- **In rotori oscillanti, i perni di trascinamento devono essere lubrificati regolarmente (Grasso lubrificante Hettich no. d'ord. 4051) per consentire un'oscillazione equilibrata dei ganci.**
- **Nel caso di centrifughe senza regolazione termica, con temperature ambiente elevate e/o con frequente impiego dell'apparecchiatura può presentarsi un riscaldamento del vano di centrifugazione. Per questo motivo non può venire esclusa una modificazione del materiale di prova a causa alla temperatura.**

- **Prima di mettere in funzione la centrifuga si devono leggere ed osservare le istruzioni per l'uso. L'apparecchio può essere utilizzato solo da persone che abbiano letto e compreso le istruzioni d'uso.**
- Oltre alle istruzioni per l'uso, si devono osservare anche i regolamenti, relativi alla protezione antinfortunistica ed i regolamenti tecnici, riconosciuti in materia di sicurezza del lavoro. Le istruzioni per l'uso vanno completate dalle norme nazionali in vigore nel paese d'impiego, relative alla protezione antinfortunistica ed alla tutela ambientale.
- La centrifuga è costruita in base all'attuale livello tecnologico e le regole di sicurezza conosciute. La centrifuga può essere tuttavia fonte di pericolo per l'operatore o per terzi, se non viene utilizzata da personale appositamente addestrato o se viene utilizzata in modo improprio o non conforme alla destinazione.
- Durante l'esercizio bisogna evitare di muovere la centrifuga o di urtarvi contro.
- In caso di guasto, ovvero del ripristino d'emergenza, non si deve assolutamente toccare il rotore.
- Quando la centrifuga passa da un ambiente freddo in uno caldo, per evitare danni dovuti alla condensa, lasciar riscaldare la centrifuga per almeno 3 ore nell'ambiente caldo prima di collegarla alla rete, oppure portare la centrifuga a temperatura d'esercizio mettendola in funzione per 30 minuti nell'ambiente freddo.
- Devono essere utilizzati esclusivamente i rotori e gli accessori omologati per questa apparecchiatura (vedere capitolo "Anhang/Appendix, Rotoren und Zubehör/Rotors and accessories"). Prima di utilizzare contenitori di centrifugazione, che non sono elencati nel capitolo "Appendice/Appendix, Rotori ed accessori/Rotors and accessories", l'utente deve accertarsi presso il costruttore, che questi possano venire utilizzati.
- Il rotore della centrifuga può essere caricato solo in conformità al capitolo " Carico del rotore".
- In caso di centrifugazione con massimo numero di giri, la densità dei materiali o delle miscele di materiali non deve superare il valore di composizione di $1,2 \text{ kg/dm}^3$.
- Non è consentito l'uso di centrifughe non bilanciate in modo regolamentare.
- Non è permesso l'impiego della centrifuga in ambiente a pericolo di esplosione.
- E' proibito l'uso di una centrifuga con:
 - materiali infiammabili od esplosivi
 - materiali che possono reagire chimicamente tra loro con forte energia.

- Se vengono centrifugate sostanze pericolose o miscele di sostanze contaminate da microrganismi tossici, radioattivi o patogeni, l'utente dovrà prendere opportuni provvedimenti in materia. È consentito esclusivamente l'impiego di contenitori di centrifugazione con speciali chiusure a vite per sostanze pericolose. Nel caso di materiali appartenenti al gruppo a rischio 3 e 4 oltre ai contenitori di centrifugazione è da utilizzare un sistema di biosicurezza (vedi manuale "Laboratory Bio-safety Manual" dell'Organizzazione mondiale per la salute).
Una ermetizzazione biologica (guarnizione ad anello) di questo sistema di biosicurezza impedisce la fuoriuscita delle goccioline e degli aerosol.
Se il gancio di un sistema di biosicurezza viene utilizzato senza il coperchio, la guarnizione ad anello deve venire tolta dal gancio, per evitare un danneggiamento della guarnizione ad anello durante il processo di centrifugazione. I sistemi di biosicurezza che sono danneggiati non sono più ermetici dal punto di vista microbiologico.
Senza l'impiego di un sistema di biosicurezza, una centrifuga non può essere considerata a tenuta ermetica dal punto di vista microbiologico ai sensi della norma EN / IEC 61010-2-020.
Per la chiusura di un sistema di biosicurezza sono da seguire le istruzioni al capitolo "Chiudere i sistemi biologici di sicurezza".
Per quanto riguarda i sistemi di biosicurezza fornibili, rimandiamo al capitolo "Appendice/Appendix, Rotori ed accessori/Rotors and accessories". Nel dubbio chiedere maggiori informazioni al produttore.
- Non è consentito il funzionamento della centrifuga con sostanze altamente corrosive che possono pregiudicare la resistenza meccanica dei rotori, delle sospensioni e degli accessori.
- Gli interventi di riparazione devono essere effettuati esclusivamente da una persona autorizzata dal costruttore.
- Devono essere impiegati solo ed esclusivamente pezzi di ricambio originali ed accessori autorizzati della ditta Andreas Hettich GmbH & Co. KG.
- Sono di validità le seguenti norme di sicurezza:
EN / IEC 61010-1 e EN / IEC 61010-2-020 come anche le loro nazionali varianti.
- La sicurezza e l'affidabilità della centrifuga sono garantite solo se:
 - la centrifuga funziona in conformità con le istruzioni per l'uso
 - l'installazione elettrica sul luogo di posizionamento della centrifuga risponde ai requisiti previsti dalla EN / IEC.
- Rientra nelle responsabilità dell'utente il rispetto degli standard specifici nazionali per la sicurezza del lavoro riguardanti l'impiego delle centrifughe di laboratorio ai posti di lavoro da lui previsti.

5 Significato dei simboli



Simbolo sull'apparecchio:
Attenzione, punto pericoloso generico.



Simbolo sull'apparecchiatura:
Prestare attenzione alle istruzioni per l'uso.
Questo simbolo indica che l'utente deve prestare attenzione alle istruzioni per l'uso fornite.



Simbolo in questo documento.
Attenzione, punto pericoloso generico.
Questo simbolo contraddistingue le avvertenze relative alla sicurezza e indica situazioni potenzialmente pericolose.
La mancata osservanza di tali avvertenze può causare danni materiali e personali.



Simbolo sull'apparecchiatura ed in questo documento:
Attenzione: rischio biologico.



Simbolo in questo documento:
Questo simbolo indica argomenti importanti.



Simbolo sull'apparecchiatura ed in questo documento:
Simbolo per la raccolta separata delle apparecchiature elettriche ed elettroniche, in conformità alle direttive 2002/96/CEE (WEEE). L'apparecchiatura appartiene al gruppo 8 (apparecchiature medicali).
Impiegare nelle nazioni dell'Unione Europea, in Norvegia ed in Svizzera.



Simbolo sull'imballaggio:
Questo lato in alto.



Simbolo sull'imballaggio:
L'imballaggio di trasporto è da immagazzinare, trasportare e manipolare esclusivamente nell'indicato range di umidità dell'aria (10% - 80%).



Simbolo sull'imballaggio:
L'imballaggio di spedizione è da immagazzinare, trasportare e manipolare esclusivamente nell'indicato range di temperatura (-20°C - +60°C).



Simbolo sull'imballaggio:
L'imballaggio di trasporto non deve venir esposto alla pioggia e deve venir conservato in ambiente asciutto.



Simbolo sull'imballaggio:
Fragile, trattare con cautela.

6 Contenuto della fornitura

I seguenti accessori vengono forniti con la centrifuga:

- 1 cavo elettrico
- 2 fusibili
- 1 grasso per perni portanti
- 1 chiave a forcella
- 1 chiave di sblocco
- 1 istruzioni per la sicurezza durante il trasporto
- 1 istruzioni per l'uso

Rotore/i e i corrispondenti accessori vengono forniti in base alla commessa.

7 Disimballo della centrifuga

- Levare il cartone verso l'alto e togliere l'imbottitura.

-  Non sollevare dall'impugnatura del coperchio.
Considerare il peso della centrifuga, vedere capitolo "Dati tecnici".

Con il numero adeguato di persone, sollevare la centrifuga da entrambi i lati e riporla sul tavolo di laboratorio.

8 Trasporto ed immagazzinaggio

8.1 Trasporto

-  Prima di effettuare il trasporto dell'apparecchiatura deve venire installato il dispositivo di sicurezza per il trasporto.

Per il trasporto dell'apparecchiatura e degli accessori devono venire rispettati i seguenti presupposti di ambiente.

- Temperatura ambiente: -20°C fino a +60°C
- Umidità relativa dell'aria: 10% fino a 80%, non condensante

8.2 Immagazzinaggio

-  L'immagazzinaggio dell'apparecchiatura e degli accessori è ammesso solo in ambienti chiusi ed asciutti.

Per l'immagazzinaggio dell'apparecchiatura e degli accessori devono essere rispettati i seguenti presupposti di ambiente.

- Temperatura ambiente: -20°C fino a +60°C
- Umidità relativa dell'aria: 10% fino a 80%, non condensante

9 Messa in funzione

- Togliere la sicura per il trasporto, che si trova sul fondo dell'alloggiamento, vedere foglio avvisi "Sicura per il trasporto".
- **Porre la centrifuga in un posto adatto e livellarla. Per l'installazione deve essere rispettata la zona di sicurezza di 300 mm attorno alla centrifuga, richiesta in conformità alle norme EN / IEC 61010-2-020.**



Durante un'operazione di centrifugazione, in una zona di sicurezza di 300 mm attorno alla centrifuga non deve sostare alcuna persona, materiali pericolosi ed oggetti, in conformità alle norme EN / IEC 61010-2-020.

- Le aperture di ventilazione non devono essere chiuse mettendo oggetti davanti. Rispetto alle feritoie di ventilazione e ad alle aperture di ventilazione della centrifuga deve venir mantenuta una distanza di 300 mm.
- Verificare se la tensione di rete sia adatta all'indicazione riportata nella targhetta con i dati caratteristici.
- Collegare la centrifuga ad una presa di rete standard utilizzando un cavo di rete. Per la potenza massima assorbita, vedere il capitolo "Dati tecnici".
- Accendere l'interruttore di rete. Posizione di accensione "I".
I dati di centrifuga utilizzati per ultimi vengono illustrati.
- Aprire il coperchio.

10 Apertura e chiusura del coperchio

10.1 Apertura del coperchio



E' possibile aprire il coperchio solo se la centrifuga è accesa ed il rotore è fermo.
Se non dovesse essere possibile, vedi capitolo "Sblocco di emergenza".

- Tirare verso l'alto la barra d'impugnatura sita sul coperchio. Nell'indicazione di rotazione  si accende il simbolo "L" (coperchio aperto).
- Aprire il coperchio.

10.2 Chiusura del coperchio



Non chiudere il coperchio sbattendolo.

- Appoggiare il coperchio e abbassare la barra d'impugnatura sita sul coperchio. Nell'indicazione di rotazione  si accende il simbolo "—" (coperchio chiuso).

11 Montaggio e smontaggio del rotore

11.1 Rotore con dado di bloccaggio

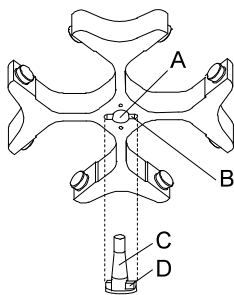

Montaggio del rotore:



Le particelle di sporco tra l'albero motore ed il rotore impediscono un perfetto posizionamento in sede del rotore e sono causa di un irrequieto movimento.

- Pulire l'albero motore (C) ed il foro del rotore (A) ed ingrassare poi leggermente l'albero motore.
- Applicare verticalmente il rotore sull'albero motore. Il trascinato dell'albero motore (D) deve trovarsi nella scanalatura del rotore (B). Sul rotore è contrassegnata la direzione della scanalatura.
- Serrare il dado di bloccaggio del rotore utilizzando la chiave che vi è stata fornita e serrando in senso orario.
- Controllare che il rotore sia fissato stabilmente.

Smontaggio del rotore:

- Sbloccare il dado di bloccaggio girandolo in senso antiorario e girare fino al punto di pressione di sollevamento. Dopo aver superato il punto di pressione di sollevamento il rotore si sblocca dal cono dell'albero motore.
- Girare il dado di bloccaggio, fino a quando il rotore si lascia sollevare dall'albero motore.

11.2 Rotore senza dado di bloccaggio

11.2.1 Montaggio e smontaggio del mozzo

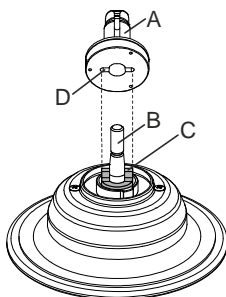

Montaggio del mozzo:

- Applicare verticalmente il mozzo (A) sull'albero motore (B). Il trascinato (C) sull'albero motore deve trovarsi nella scanalatura (D) del mozzo.
- Serrare il dado di bloccaggio del mozzo utilizzando la chiave a brugola esagonale che vi è stata fornita e girando in senso orario.
- Controllare che il mozzo sia fissato stabilmente.

Smontaggio del mozzo:

- Estrarre il rotore.
- Sbloccare il dado di bloccaggio del mozzo girando in senso antiorario e girare fino al punto di pressione di sollevamento. Dopo aver superato il punto di pressione di sollevamento il mozzo si sblocca dal cono dell'albero motore.
- Girare il dado di bloccaggio, fino a quando il mozzo si lascia sollevare dall'albero motore.

11.2.2 Installazione ed estrazione del rotore

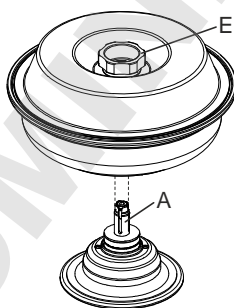

Installazione del rotore:



Le particelle di sporco tra il mozzo ed il rotore impediscono un perfetto posizionamento in sede del rotore e sono causa di un irrequieto movimento. In caso di necessità prima di installare il rotore pulire il mozzo (A) sull'albero motore ed il mozzo del rotore.

- Sollevare il rotore tenendolo alla manopola (E) del coperchio, applicarlo in orizzontale sul mozzo (A) e premere verso il basso fino al fermo di arresto.

Estrazione del rotore:

- Trattenere il rotore tenendolo alla manopola (E) del coperchio e sollevare dal mozzo (A).

12 Applicare ed estrarre i ganci dal rotore

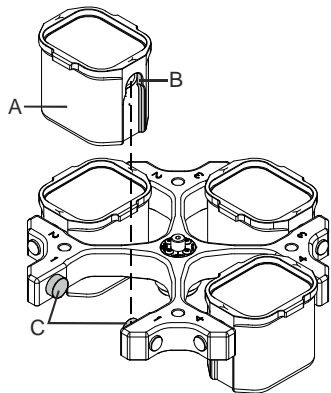

Nel caso di rotori di smorzamento, tutti i posti del rotore devono essere occupati con ganci **uguali**.



Particolari ganci sono contrassegnati con il numero del posto del rotore. L'applicazione di questi ganci è consentita esclusivamente nel corrispondente posto del rotore.

L'applicazione di ganci contrassegnati con un numero di set, p.es. S001/4, è consentita esclusivamente in set.

Applicare i ganci nel rotore:

- Controllare che il rotore sia fissato stabilmente.
- Ingrassare i perni di supporto (C) (grasso lubrificante Hettich N° 4051).
- Applicare i ganci (A) nel rotore. A questo riguardo prestare attenzione che i perni di supporto (C) si trovino nelle scanalature (B) dei ganci.
- Spingere i ganci verso il basso fino al fermo di arresto.

Estrarre i ganci dal rotore:

- Estrarre dal rotore, perpendicolarmente verso l'alto, i ganci (A).

13 Applicare ed estrarre dai ganci l'adattatore

Applicare l'adattatore nei ganci:

- Applicare orizzontalmente l'adattatore (A) nei ganci (B).

Estrarre l'adattatore dai ganci:

- Estrarre verso l'alto l'adattatore (A) dai ganci (B).

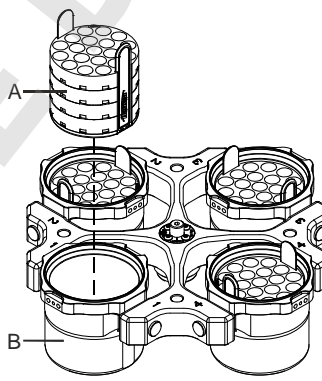
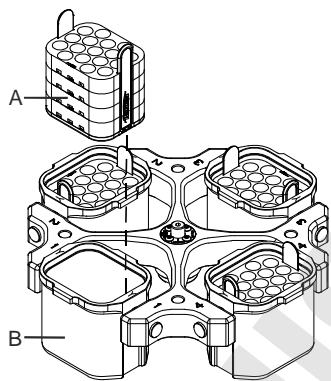

14 Applicare nel gancio l'adattatore con il perno di posizionamento

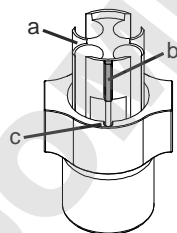

- Applicare l'adattatore (a) nel gancio in modo, che il perno di posizionamento (b) si trovi nella scanalatura (c) del gancio.



Se l'adattatore (a) non viene applicato in modo esatto, i contenitori di centrifugazione possono venir danneggiati durante il processo di centrifugazione.

15 Carico del rotore

 Lo standard dei recipienti di vetro centrifugati sono da caricare fino a RCF 4000 (DIN 58970 capoverso 2).

- Verificare che il rotore sia fissato.
- Nel caso di rotori oscillanti, tutti i siti del rotore devono essere muniti di ganci **uguali**. Particolari ganci sono contrassegnati con il numero del sito del rotore. Questi ganci devono essere applicati solo nel relativo sito del rotore.
Ganci contrassegnati con un numero di kit, p.es. S001/4, devono essere utilizzati esclusivamente in kit.
- I rotori ed i ganci devono essere caricati esclusivamente in modo simmetrico. I recipienti di centrifuga devono essere distribuiti uniformemente su tutti i posti del rotore. Per le combinazioni permesse vedere capitolo "Anhang/Appendix, Rotoren und Zubehör/Rotors and accessories".
In caso di rotori angolari devono essere caricati tutti i possibili siti del rotore, vedere il capitolo "Anhang/Appendix, Rotoren und Zubehör/Rotors and accessories".

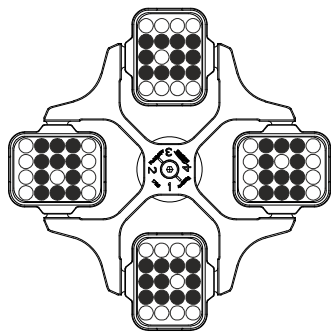

Il rotore è caricato in modo simmetrico

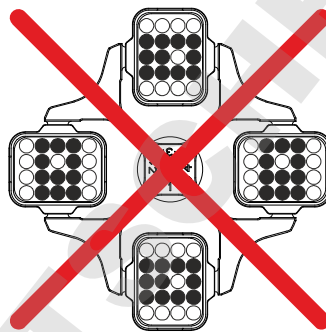

Non ammesso!
Il rotore è caricato in modo non simmetrico

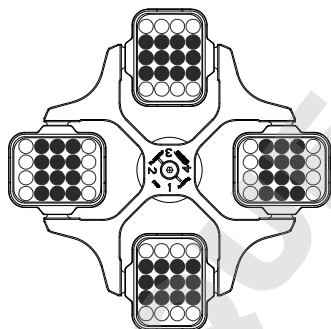

Il rotore è caricato uniformemente

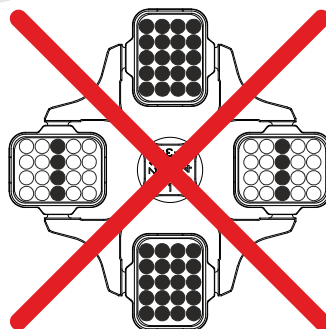

Non ammesso!
Il rotore è caricato in modo non uniforme

- Su certe sospensioni è indicato il peso del carico massimo oppure il peso del carico massimo e il peso massimo della sospensione completamente equipaggiata. Questi pesi non devono essere superati. In casi eccezionali vedere al capitolo "Centrifugazione di sostanze o di miscele di sostanze con densità maggiore di 1,2 kg/dm³". L'indicazione del peso di carico massimo comprende il peso complessivo dell'adattatore, il contenitore di centrifugazione ed il contenuto.

- Nel caso di contenitori con inserimenti in gomma, deve essere sempre mantenuto lo stesso numero di inserimenti in gomma sotto i contenitori di centrifugazione.
- L'operazione di riempimento dei contenitori di centrifugazione è ammessa solo al di fuori della centrifuga.
- Il carico massimo dei recipienti della centrifuga non deve essere superiore a quello indicato dalla casa costruttrice.

Con rotori a squadra, il riempimento dei contenitori di centrifugazione è consentito solo fino al livello per cui, durante l'operazione di centrifugazione, non venga espulso alcun liquido dai contenitori.

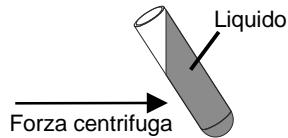

- Con il caricamento di rotori a squadra non deve pervenire alcun liquido nei rotori a squadra e nel vano di centrifugazione.
- Con il caricamento dei ganci dei rotori di smorzamento come anche con lo smorzamento dei ganci durante l'operazione di centrifuga non deve pervenire alcun liquido nei ganci e nel vano di centrifugazione.
- Per limitare al massimo le differenze di peso all'interno dei contenitori di centrifugazione, bisogna fare attenzione che siano riempiti tutti in modo uguale.

16 Chiudere i sistemi biologici di sicurezza



Per garantire la tenuta, il coperchio di un sistema biologico di sicurezza deve essere ben chiuso.

Per evitare che durante l'apertura e la chiusura del coperchio l'anello di guarnizione si giri, spalmarvi, frizionando leggermente, una sostanza per la cura della gomma.

Se la sospensione di un sistema di sicurezza biologico viene usata senza coperchio, la guarnizione ad anello deve essere rimossa dalla sospensione per evitare di danneggiarla durante il ciclo di centrifugazione. Le guarnizioni ad anello danneggiate non possono più essere utilizzate per la chiusura a tenuta del sistema di sicurezza biologico.

Per quanto riguarda i sistemi biologici di sicurezza fornibili, rimandiamo al capitolo "Anhang/Appendix, Rotoren und Zubehör/Rotors and accessories". Nel dubbio chiedere maggiori informazioni al produttore o importatore.

Coperchio con chiusura a vite

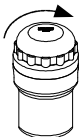

- Applicare il coperchio sul gancio.
- Chiudere con forza a mano il coperchio, girando in senso orario.

17 Elementi di operazione e visualizzazione

Vedere illustrazione alla pagina 2.

Fig. 2: Display

17.1 Simboli del quadro comandi



Indicazione di rotazione. L'indicatore di rotazione si illumina ruotando in senso antiorario fino a che il rotore gira.

All'arresto del rotore, l'indicazione di rotazione visualizza mediante simboli lo stato del coperchio:

Simbolo  : coperchio aperto

Simbolo  : coperchio chiuso



Gli errori di operazione e i guasti sono visualizzati sul display (vedere capitolo "Guasti").

17.2 Pulsanti e possibilità di regolazione

RPM/RCF x 100



- Velocità di rotazione

Si può regolare un valore numerico da 500 RPM fino alla velocità massima di rotazione del rotore. Per la velocità massima di rotazione del rotore, vedere capitolo "Appendice/Appendix, Rotori e accessori/Rotors and accessories". Regolabile in intervalli di 100 (RPM = valore visualizzato x 100). Tenendo premuto il pulsante  o  il valore cambia a velocità crescente.

- Visualizzare il livello di frenatura e il raggio di centrifugazione.

t



- Tempo ciclo

- Regolabile da 1 a 99 minuti, in intervalli di 1 minuto
- Funzionamento continuo "--"

- Raggio di centrifugazione. Immissione in centimetri. Regolabile da 5 a 16 centimetri, in intervalli di 1 centimetro. Per il raggio di centrifugazione, vedere capitolo "Appendice/Appendix, Rotori e accessori/Rotors and accessories".

- Livelli di frenatura 0 o 1. Livello 1 = tempo di arresto breve, livello 0 = tempo di arresto lungo.

Tenendo premuto il pulsante  o  il valore cambia a velocità crescente.



- Avvio del ciclo di centrifugazione.



- Termine del ciclo di centrifugazione.
Il rotore si arresta con il livello di frenatura preselezionato.
- Memorizzare il livello di frenatura e il raggio di centrifugazione.



- Indicazione dell'accelerazione centrifuga relativa (RCF).

L'accelerazione centrifuga relativa (RCF) viene visualizzata finché si tiene premuto il pulsante .



- Centrifugazione a impulsi.

Il ciclo di centrifugazione ha luogo finché si tiene premuto il pulsante .

- Visualizzare il livello di frenatura e il raggio di centrifugazione.

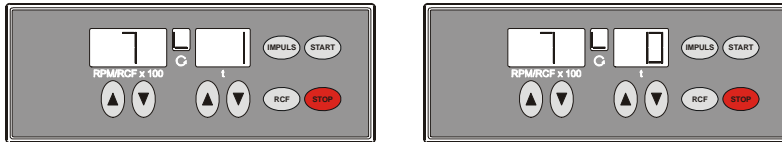

18 Regolazione del livello di frenatura

- Disinserire l'interruttore di rete.
- Tenere premuti contemporaneamente il pulsante  al di sotto dell'indicazione della velocità di rotazione e il pulsante **(IMPULS)**.
- Inserire l'interruttore di rete e rilasciare i pulsanti.
Nell'indicatore della velocità di rotazione viene visualizzata la versione della macchina e nell'indicatore del tempo il livello di frenatura impostato, per esempio:



Se la versione della macchina e il livello di frenatura non sono visualizzati, premere il numero di volte necessario a far apparire tali informazioni il tasto  che si trova sotto l'indicazione della velocità di rotazione.



La versione della macchina è impostata dalla casa costruttrice e non può essere cambiata.

- Con i pulsanti   al di sotto dell'indicazione del tempo, regolare il livello di frenatura desiderato. Livello 1 = tempo di arresto breve, livello 0 = tempo di arresto lungo.
Per i tempi di arresto, vedere capitolo "Anhang/Appendix, Rotoren und Zubehör/Rotors and accessories".
- Premere il pulsante **(STOP)** per salvare l'impostazione.

19 Regolazione del raggio di centrifugazione



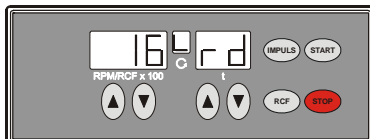

Il raggio di centrifugazione deve essere immesso in centimetri.

- Disinserire l'interruttore di rete.
- Tenere premuti contemporaneamente il pulsante  al di sotto dell'indicazione della velocità di rotazione e il pulsante **(IMPULS)**.
- Inserire l'interruttore di rete e rilasciare i pulsanti.
- Premere il pulsante  al di sotto dell'indicazione della velocità di rotazione finché appare la seguente visualizzazione:



Nell'indicazione della velocità di rotazione viene visualizzato il raggio di centrifugazione impostato.



- Con i pulsanti   al di sotto dell'indicazione del tempo regolare il raggio di centrifugazione desiderato.
Per il raggio di centrifugazione, vedere capitolo "Anhang/Appendix, Rotoren und Zubehör/Rotors and accessories".
- Premere il pulsante **(STOP)** per salvare l'impostazione.



20 Centrifugazione

 Durante un'operazione di centrifugazione, in una zona di sicurezza di 300 mm attorno alla centrifuga non deve sostare alcuna persona, materiali pericolosi ed oggetti, in conformità alle norme EN / IEC 61010-2-020.

 Se la differenza di peso permessibile nel carico del rotore è superata, l'azionamento si disinserisce durante l'avvio e viene visualizzato l'errore -3- (vedere capitolo "Guasti").

Un ciclo di centrifugazione può essere interrotto in qualsiasi momento premendo il pulsante **STOP**.

Il tempo e la velocità di rotazione possono essere modificati durante il ciclo di centrifugazione con i pulsanti  .

Tenere premuto il pulsante  o  per modificare il valore a velocità crescente.





Dopo un ciclo di centrifugazione l'indicazione lampeggia fino all'apertura del coperchio o finché un pulsante viene premuto.

Se nell'indicazione di rotazione  i simboli "—" (coperchio chiuso) e "L" (coperchio aperto) lampeggiano alternativamente, è possibile riutilizzare la centrifuga solo dopo aver aperto una volta il coperchio.

Se viene visualizzato **rot xx**, non ha avuto luogo alcun ciclo di centrifugazione a causa di una precedente sostituzione del rotore, vedere capitolo "Riconoscimento del rotore".

- Inserire l'interruttore di rete (posizione interruttore "I").
- Caricare il rotore e chiudere il coperchio della centrifuga.

20.1 Centrifugazione con preselezione del tempo





- Con i pulsanti   al di sotto dell'indicazione della velocità di rotazione impostare la velocità di rotazione desiderata.
- Con i pulsanti   al di sotto dell'indicazione del tempo regolare il tempo desiderato.
- Premere il pulsante **START**. L'indicazione di rotazione  è accesa finché il rotore gira.

 Il tempo è visualizzato in minuti. L'ultimo minuto è contato in secondi.
Se il tempo è visualizzato in minuti, a fianco del numero lampeggia un punto.

- Allo scadere del tempo o in caso di interruzione del ciclo di centrifugazione con il tasto **STOP**, il rotore si arresta gradualmente con il livello di frenatura impostato.

Durante il ciclo di centrifugazione sono visualizzati la velocità di rotazione del rotore o il valore RCF risultante e il tempo rimanente.

20.2 Funzionamento continuo



- Con i pulsanti   al di sotto dell'indicazione della velocità di rotazione impostare la velocità di rotazione desiderata.
- Con il pulsante  al di sotto dell'indicazione del tempo azzerare il tempo. Viene visualizzato "--".
- Premere il pulsante **START**. L'indicazione di rotazione  è accesa finché il rotore gira. Il conteggio del tempo inizia da 0.

 Il primo minuto è contato in secondi, quindi il tempo è visualizzato in minuti.
Se il tempo è visualizzato in minuti, a fianco del numero lampeggia un punto.

- Premere il pulsante **STOP** per terminare il ciclo di centrifugazione. Il rotore si arresta gradualmente con il livello di frenatura impostato.

Durante il ciclo di centrifugazione sono visualizzati la velocità di rotazione del rotore o il valore RCF risultante e il tempo trascorso.

20.3 Centrifugazione a impulsi

- Con i pulsanti   al di sotto dell'indicazione della velocità di rotazione impostare la velocità di rotazione desiderata.
- Tenere premuto il pulsante **IMPULS**. L'indicazione di rotazione  è accesa finché il rotore gira. Il conteggio del tempo inizia da 0.

 Il primo minuto è contato in secondi, quindi il tempo è visualizzato in minuti.
Se il tempo è visualizzato in minuti, a fianco del numero lampeggia un punto.

- Rilasciare il pulsante **IMPULS** per terminare il ciclo di centrifugazione. Il rotore si arresta gradualmente con il livello di frenatura impostato.

Durante il ciclo di centrifugazione sono visualizzati la velocità di rotazione del rotore e il tempo trascorso.

20.4 Visualizzazione dell'accelerazione centrifuga relativa (RCF)

Durante il ciclo di centrifugazione è possibile visualizzare l'accelerazione centrifuga relativa (RCF).



Se si utilizza l'accelerazione centrifuga relativa (RCF), è necessario immettere il raggio di centrifugazione.

- Durante il ciclo di centrifugazione tenere premuto il pulsante **[RCF]**.
L'accelerazione centrifuga relativa (RCF) appare nell'indicazione della velocità di rotazione (RCF = valore visualizzato x 100).
- Rilasciare il pulsante **[RCF]**. È nuovamente visualizzata la velocità di rotazione.

21 Segnale acustico

Il segnale acustico si attiva quando:

- dopo il verificarsi di un guasto con un intervallo di 2 secondi;
- dopo il termine della corsa di centrifugazione e arresto del rotore con un intervallo di 30 secondi.

Aperto il coperchio oppure premendo un tasto qualsiasi, il segnale acustico cessa.

Se si arresta il rotore, il segnale acustico può essere attivato o disattivato nel modo seguente:

- Disinserire l'interruttore di rete.
- Tenere premuti contemporaneamente il pulsante **[▲]** al di sotto dell'indicazione della velocità di rotazione e il pulsante **[IMPULS]**.
- Inserire l'interruttore di rete e rilasciare i pulsanti.
- Premere il pulsante **[▲]** al di sotto dell'indicazione della velocità di rotazione finché appare la seguente visualizzazione:

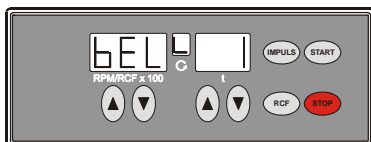

Nel display del tempo viene esposta l'impostazione del segnale acustico.

0 = Segnale acustico disattivato, 1 = Segnale acustico attivato.

- Con i tasti **[▲]** **[▼]** impostare **0** oppure **1** al di sotto del display del tempo.
- Premere il pulsante **[STOP]** per salvare l'impostazione.

22 Accelerazione centrifuga relativa (RCF)

L'accelerazione centrifuga relativa (RCF) è indicata come un multiplo dell'accelerazione terrestre (g). È un valore numerico privo di unità e funge per paragonare le prestazioni di separazione e sedimentazione.

Il calcolo viene eseguito in base alla formula:

$$RCF = \left(\frac{RPM}{1000} \right)^2 \times r \times 1,118 \quad \Rightarrow \quad RPM = \sqrt{\frac{RCF}{r \times 1,118}} \times 1000$$

RCF = accelerazione centrifuga relativa

RPM = numero dei giri

r = raggio di centrifugazione in mm = distanza dal centro dell'asse di rotazione fino al fondo del recipiente di centrifugazione. Raggio di centrifugazione vedi al capitolo "Anhang/Appendix, Rotoren und Zubehör/Rotors and accessories".



L'accelerazione centrifuga relativa (RCF) dipende dal numero dei giri e dal raggio di centrifugazione.

23 Centrifugazione di sostanze o di miscele di sostanze con densità maggiore di 1,2 kg/dm³

In caso di centrifugazione con massimo numero di giri, la densità dei materiali o delle miscele di materiali non deve superare il valore di composizione di 1,2 kg/dm³.

Con sostanze o miscele di sostanze di densità maggiore, il regime di rotazione deve venire ridotto.

Il numero di giri consentito si calcola con la formula seguente:

$$\text{numero di giri ridotto (n}_{\text{red}}) = \sqrt{\frac{1,2}{\text{densità maggiore [kg/dm}^3]}} \times \text{regime massimo di rotazione [RPM]}$$

p.es.: regime massimo di rotazione RPM 4000, densità 1,6 kg/dm³

$$n_{\text{red}} = \sqrt{\frac{1,2 \text{ kg/dm}^3}{1,6 \text{ kg/dm}^3}} \times 4000 \text{ RPM} = 3464 \text{ RPM}$$

Se in casi eccezionali viene superato il carico massimo indicato sul gancio, il regime di rotazione deve essere ridotto.

Il numero di giri consentito si calcola con la formula seguente:

$$\text{numero di giri ridotto (n}_{\text{red}}) = \sqrt{\frac{\text{carico massimo [g]}}{\text{carico effettivo [g]}}} \times \text{regime massimo di rotazione [RPM]}$$

p.es.: regime massimo di rotazione RPM 4000, carico massimo 350 g, carico effettivo 300 g

$$n_{\text{red}} = \sqrt{\frac{300 \text{ g}}{350 \text{ g}}} \times 4000 \text{ RPM} = 3703 \text{ RPM}$$

In caso di dubbio, rivolgersi al costruttore per maggiori informazioni.

24 Riconoscimento del rotore

Con l'inizio di ogni corsa di centrifugazione avviene il riconoscimento del rotore installato.

Dopo una sostituzione del rotore, il ciclo di centrifugazione si interrompe dopo il riconoscimento del rotore. Viene visualizzato il codice (rot xx) del rotore.

- Premere il tasto **START**. I dati di centrifuga utilizzati per ultimi vengono illustrati.



L'ulteriore utilizzo della centrifuga è possibile solo dopo avere aperto una volta il coperchio.

Se il numero di giri massimo del rotore utilizzato è inferiore al numero di giri impostato, la velocità viene limitata al numero di giri massimo del rotore.

25 Sblocco di emergenza

In caso di mancanza di corrente non si può aprire il coperchio. Deve essere effettuata manualmente uno sblocco di emergenza.



Per lo sblocco di emergenza, disconnettere la centrifuga dalla rete elettrica.

Aprire il coperchio solo con l'arresto del rotore.

Per lo sblocco di emergenza si può usare solo la chiave di sbocco di plastica in dotazione.

Vedere illustrazione alla pagina 2.

- Disinserire l'interruttore di rete (posizione interruttore "0").
- Guardare attraverso la finestra presente nel coperchio per assicurarsi che il rotore sia fermo.
- Introdurre orizzontalmente nel foro (Fig. 1, A) il perno di sblocco. Spingere in dentro la spina di sbloccaggio fino a quando, premendo verso il basso la spina, la maniglia si lascia girare verso l'alto.
- Aprire il coperchio.

26 Pulizia e manutenzione



L'apparecchiatura può essere contaminata.



Prima della pulizia, staccare la presa di corrente.

Prima di iniziare un procedimento di pulizia e decontaminazione diverso da quello consigliato dal produttore, l'utilizzatore deve accertarsi presso il produttore che tale procedimento previsto non rechi danno all'apparecchio.

- Centrifughe, rotori e accessori non devono essere lavati in lavastoviglie.
- Si deve eseguire solo una pulizia manuale ed una disinfezione con liquido.
- La temperatura dell'acqua deve essere di 20 – 25°C.
- Devono essere utilizzati solo detersivi o disinfettanti che:
 - abbiano un campo di valori del pH che va da 5 a 8,
 - non contengano alcali caustici, perossidi, composti di cloro, acidi e soluzioni alcaline.
- Seguire attentamente le indicazioni speciali del produttore sull'impiego di detersivi e disinfettanti, al fine di evitare qualsiasi fenomeno di corrosione.

26.1 Centrifughe (scatola, coperchio e vano di centrifugazione)

26.1.1 Cura e pulizia delle superfici

- Pulire regolarmente il corpo della centrifuga e la camera di centrifugazione e impiegare all'occorrenza sapone o un detersivo delicato e un panno umido. Ciò serve da un lato per l'igiene e dall'altro lato per evitare la corrosione causata da impurità incrostate.
- Ingredienti dei detersivi adatti:
sapone, tensidi anionici, tensidi non ionici.
- Dopo l'impiego di detersivi, rimuovere i resti del detersivo pulendo di nuovo con un panno umido.
- Le superfici devono essere asciugate subito dopo la pulizia.
- In caso di formazione di acqua di condensa, asciugare la camera di centrifugazione pulendola con un panno assorbente.
- Spalmare sulla guarnizione di gomma della camera di centrifugazione, frizionando leggermente, una sostanza per la cura della gomma.
- Controllare una volta l'anno se il vano di centrifugazione presenta danneggiamenti.



Se vengono stabiliti danni rilevanti per la sicurezza, la centrifuga non deve essere più messa in funzione. In questo caso si deve contattare il servizio assistenza clienti.

26.1.2 Disinfezione delle superfici

- In presenza di materiale infettivo nella camera di centrifugazione si deve disinfettarla immediatamente.
- Ingredienti dei disinfettanti adatti:
etanolo, alcol n proclitico, etilexanolo, tensidi anionici, inibitori di corrosione.
- Dopo l'impiego di disinfettanti, rimuovere i resti del disinfettante pulendo di nuovo con un panno umido.
- Le superfici devono essere asciugate subito dopo la disinfezione.

26.1.3 Rimuovere contaminazioni radioattive

- La sostanza deve essere certificata in modo speciale per rimuovere contaminazioni radioattive.
- Ingredienti di sostanze adatte alla rimozione di contaminazioni radioattive:
tensidi anionici, tensidi non ionici, etanolo poliidrato.
- Dopo aver rimosso le contaminazioni radioattive, rimuovere i resti della sostanza pulendo di nuovo con un panno umido.
- Le superfici devono essere asciugate, subito dopo la rimozione delle contaminazioni radioattive.

26.2 Rotori ed accessori

26.2.1 Pulizia e cura

- Per prevenire corrosione e alterazioni dei materiali, i rotor e l'accessorio devono essere regolarmente puliti con sapone o con un detergente delicato e con un panno umido. Si consiglia la pulizia almeno una volta la settimana. La sporcizia deve essere subito rimossa.
- Ingredienti dei detergenti adatti:
sapone, tensidi anionici, tensidi non ionici.
- Dopo l'impiego di detergenti, rimuovere i resti del detergente, risciacquando con acqua (solo al di fuori della centrifuga) o ripulendo con un panno umido.
- I rotor e gli accessori devono essere asciugati immediatamente dopo la pulizia.
- I rotor ad angolo, i contenitori e i supporti in alluminio devono essere ingrassati leggermente con grasso privo d'acidi come ad esempio vaselina quando sono ben asciutti.
- Le guarnizioni ad anello dei sistemi di biosicurezza sono da pulire settimanalmente.
Le guarnizioni ad anello sono realizzate in silicone. Per garantire l'ermeticità dei sistemi di biosicurezza, dopo la pulizia od il trattamento in autoclave non è consentito il trattamento delle guarnizioni ad anello con polvere di talco.
Prima di qualsiasi utilizzo del sistema di biosicurezza deve venir controllato il perfetto stato di tutti i suoi componenti. Deve venir controllata inoltre l'esatta posizione di installazione della guarnizione ad anello ovvero delle guarnizioni ad anello del sistema di biosicurezza.
I componenti danneggiati del sistema di biosicurezza devono venire immediatamente sostituiti.
In presenza di incrinature, infragilimento od usura la guarnizione ad anello interessata deve venir sostituita immediatamente. Nel caso di coperchi con guarnizioni ad anello non sostituibili deve venir sostituito l'intero coperchio.
Per quanto riguarda i sistemi di biosicurezza fornibili, rimandiamo al capitolo "Appendice/Appendix, Rotori ed accessori/Rotors and accessories".
- Per evitare la corrosione causata dall'umidità tra il rotore e l'albero motore, si deve provvedere almeno una volta al mese di smontare il rotore, pulirlo e di lubrificare leggermente l'albero motore.
- I rotor e gli elementi accessori devono essere verificati settimanalmente per quanto riguarda il loro stato di usura ed i danneggiamenti da corrosione.
Con i motori di smorzamento devono essere verificati soprattutto il settore dei perni di supporto e per i ganci le scanalature, verificare inoltre l'eventuale presenza di incrinature nel fondo.
Esempio: Incrinatura nel settore della scanalatura.



 Rotori ed accessori non devono essere più utilizzati se presentano consumo o corrosione.

- Verificare settimanalmente la posizione del rotore.

26.2.2 Disinfezione

- Se del materiale infetto viene a contatto con i rotor o con gli accessori, allora si deve eseguire una disinfezione adeguata.
- Ingredienti dei disinfettanti adatti:
etanolo, alcol n proclitico, etilexanolo, tensidi anionici, inibitori di corrosione.
- Dopo l'impiego di disinfettanti, rimuovere i resti del disinfettante, risciacquando con acqua (solo al di fuori della centrifuga) o ripulendo con un panno umido.
- I rotor e gli accessori devono essere asciugati immediatamente dopo la disinfezione.

26.2.3 Rimuovere contaminazioni radioattive

- La sostanza deve essere certificata in special modo per rimuovere contaminazioni radioattive.
- Ingredienti di sostanze adatte alla rimozione di contaminazioni radioattive: tensidi anionici, tensidi non ionici, etanolo poliidrato.
- Dopo la rimozione delle contaminazioni radioattive, rimuovere la sostanza, risciacquando con acqua (solo al di fuori della centrifuga) o ripulendo con un panno umido.
- I rotori e gli accessori devono essere asciugati subito dopo la rimozione delle contaminazioni radioattive.

26.2.4 Perni di trascinamento

In rotori oscillanti, i perni di trascinamento devono essere lubrificati regolarmente (Grasso lubrificante Hettich no. d'ord. 4051) per consentire un'oscillazione equilibrata dei ganci.

26.2.5 Rotori ed accessori con limitata durata di impiego

L'impiego di particolari rotori, ganci ed elementi accessori è limitato nel tempo.

Questi sono contrassegnati con la quantità max. di cicli di funzionamento o dalla data di scadenza ed il numero massimo di cicli di funzionamento o solo con la data di scadenza, p.es.:

- "einsetzbar bis Ende: IV. Quartal 2011 / usable until end of: IV. trimestre 2011" (utilizzabile fino alla fine: IV. trimestre 2011) o
- "einsetzbar bis Ende Monat/Jahr: 10/2011 / usable until end of month/year: 10/2011" (utilizzabile fino a fine mese/anno: 10/2011)
- "max. Laufzyklen / max. cycles: 40000". (Max. funzionamento cicli)



Per motivi di sicurezza l'impiego dei rotori, dei ganci e degli elementi di accessorio non è più ammesso, quando è raggiunta la quantità massima permessa dei cicli di funzionamento che è sopracontrassegnata o quando è raggiunta la data di scadenza sopracontrassegnata.

26.3 Trattamento in autoclave

I seguenti accessori possono essere trattati in autoclave a 121°C / 250°F (20 min).

- Rotori di smorzamento
- Rotori a squadra in alluminio
- Gancio in metallo
- Coperchio con ermetizzazione biologica
- Adattatore

Per quanto riguarda il grado di sterilizzazione non può essere citato alcun dato.



I coperchi dei rotori ed i serbatoi devono venir tolti prima del trattamento in autoclave.

Il trattamento in autoclave accelera il processo di invecchiamento delle plastiche. Oltre a ciò può provocare il cambiamento di colorazione delle plastiche.

Dopo il trattamento in autoclave deve venir controllata visivamente l'eventuale presenza di danneggiamenti ai rotori ed agli accessori ed i componenti eventualmente danneggiati devono essere immediatamente sostituiti.

In presenza di incrinature, infragilimento od usura la guarnizione ad anello interessata deve venir sostituita immediatamente.

Nel caso di coperchi con guarnizioni ad anello non sostituibili deve venir sostituito l'intero coperchio.

Per garantire l'ermeticità dei sistemi di biosicurezza, dopo il trattamento in autoclave non è consentito il trattamento delle guarnizioni ad anello con polvere di talco.

26.4 Contenitori centrifuga

- In caso di mancanza di tenuta o dopo la rottura dei contenitori per centrifugazione, rimuovere completamente i frammenti dei contenitori, le schegge di vetro e il centrifugato fuoriuscito.
- Dopo la rottura di parti in vetro, sostituire gli inserti di gomma e i manicotti di plastica dei rotori.



Le schegge di vetro rimaste causano ulteriori rotture!

- Nel caso di materiale infettivo, bisogna provvedere immediatamente ad una disinfezione.

27 Guasti

Se non si riesce a eliminare l'errore seguendo le indicazioni della tabella guasti, informare il servizio assistenza clienti.

Si prega di indicare il tipo di centrifuga e il numero di serie. Entrambi i numeri sono visibili sulla targhetta di modello della centrifuga.

	Esecuzione di un RESET RETE: <ul style="list-style-type: none"> - Disinserire l'interruttore di rete (posizione interruttore "0"). - Attendere almeno 10 secondi quindi reinserire l'interruttore di rete (posizione interruttore "1").
---	--

Guasto	Indicatore	Causa dell'errore	Eliminazione
Nessun indicatore	---	Assenza di tensione Scatto del fusibile di sicurezza per sovracorrente.	<ul style="list-style-type: none"> - Controllare la tensione di alimentazione. - Controllare i fusibili di ingresso di rete, vedere il capitolo "Sostituzione fusibili entrata rete". - Interruttore generale ACCESO.
Errore del tachimetro	- 1 -	Mancanza degli impulsi del numero di giri durante il funzionamento.	<ul style="list-style-type: none"> - L'apparecchio non deve essere spento fintanto che l'indicazione della centrifugazione  lampeggia seguendo il movimento circolare. Attendere che nel display della centrifugazione appaia il simbolo "—" (Coperchio chiuso), circa 100 secondi, quindi eseguire un "RESET DELLA RETE".
Reset di rete	- 2 -	Interruzione di rete durante il ciclo di centrifugazione. (Il ciclo di centrifugazione non viene terminato.)	<ul style="list-style-type: none"> - Dopo una fase di inattività aprire il coperchio ed azionare il tasto (START). - All'occorrenza ripetere il ciclo di centrifugazione.
Squilibrio	- 3 -	Il rotore è caricato in modo non uniforme.	<ul style="list-style-type: none"> - Aprire il coperchio dopo una fase di inattività del rotore. - Controllare il caricamento del rotore, vedere il capitolo "Carico del rotore". - Ripetere il ciclo di centrifugazione.
Comunicazione	- 4 -	Errore nel modulo di comando o potenza.	<ul style="list-style-type: none"> - Dopo l'arresto del rotore eseguire un RESET RETE.
Sovraccarico	- 5 -	Motore o comandi del motore difettosi.	<ul style="list-style-type: none"> - Dopo l'arresto del rotore eseguire un RESET RETE.
Sovratensione Sottotensione	- 6 - - 8 -	Tensione di rete oltre le tolleranze (vedi dati tecnici).	<ul style="list-style-type: none"> - Dopo l'arresto del rotore eseguire un RESET RETE - Controllare la tensione di rete.
N° giri eccedente	- 7 -	Errore nel comando.	<ul style="list-style-type: none"> - Dopo l'arresto del rotore eseguire un RESET RETE.
Sovratemperatura	- 9 -	Il termostato di massima nel motore è scattato.	<ul style="list-style-type: none"> - Dopo una fase di inattività del rotore, aprire il coperchio mediante lo sbloccaggio di emergenza (vedi capitolo Sbloccaggio di emergenza). - Far raffreddare il motore.
Errore di versione	Nell'indicatore e del tempo viene indicato un numero.	Impostata una versione errata della macchina, il modulo di comando salta al menu di regolazione.	<ul style="list-style-type: none"> - Con i tasti   presenti sotto l'indicatore impostare il numero 4. - Premere il pulsante (STOP) per salvare l'impostazione. - Esecuzione di un RESET RETE.
Controller-Watchdog	- C -	Errore nel modulo di comando.	<ul style="list-style-type: none"> - Dopo l'arresto del rotore eseguire un RESET RETE.
Errore nella chiusura del coperchio.	- d -	Errore blocco coperchio, ovvero chiusura coperchio.	<ul style="list-style-type: none"> - Dopo l'arresto del rotore eseguire un RESET RETE.
Corto circuito	- E -	Corto circuito nel modulo di comando / potenza.	<ul style="list-style-type: none"> - Dopo l'arresto del rotore eseguire un RESET RETE.
Nessun codice di rotore	- F -	Nessuna identificazione del rotore all'avvio. Nessun rotore installato o tachimetro difettoso.	<ul style="list-style-type: none"> - Dopo l'arresto del rotore eseguire un RESET RETE.
Identificazione nuovo rotore	rot...	Vedi capitolo identificazione sul rotore	<ul style="list-style-type: none"> - Premere il pulsante (START).

28 Sostituzione fusibili entrata rete



Spegner l'interruttore di rete e staccare l'apparecchio dall'alimentazione!

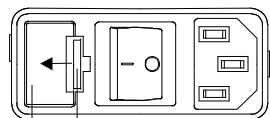

A B

Il portafusibili (A) con i fusibili d'entrata rete si trova accanto all'interruttore di rete.

- Estrarre il cavo di collegamento dalla spina.
- Premere la chiusura a scatto (B) contro il portafusibili (A) ed estrarre quest'ultimo.
- Sostituire i fusibili di rete difettosi.



Utilizzate solo fusibili con valori nominali fissati per il rispettivo tipo, vedere la successiva tabella.

- Inserire di nuovo il portafusibili fino a far scattare la chiusura.
- Allacciare di nuovo l'apparecchio alla rete.

Modello	Tipo	Fusibile	N° ord.
ROTOFIX 32 A	1206, 1206-34	T 3.15 AH/250V	E997
ROTOFIX 32 A	1206-01, 1206-33	T 5 AH/250V	E914

29 Rispedizione di apparecchi



Prima di rispedire un apparecchio deve essere montata la protezione per il trasporto.

Se l'apparecchio o uno dei suoi accessori viene rispedito alla ditta Andreas Hettich GmbH & Co. KG, esso deve essere prima decontaminato e pulito per la tutela di persone, ambiente e materiale.

Ci riserviamo la facoltà di accettare apparecchi o accessori contaminati.

Eventuali costi di pulizia e disinfezione verranno fatturati al cliente.

Contiamo a questo riguardo sulla vostra comprensione.

30 Smaltimento

Prima dello smaltimento, l'apparecchiatura deve essere decontaminata e pulita con lo scopo di proteggere le persone, l'ambiente e il materiale.

Per lo smaltimento dell'apparecchio osservare le rispettive norme di legge.

Ai sensi della direttiva 2002/96/CE (RAEE) tutti gli apparecchi forniti dopo il 13/08/2005 non possono più essere smaltiti con i rifiuti domestici. Questo apparecchio appartiene alla categoria 8 (Dispositivi medicali) ed è classificato nel settore Business-to-Business.











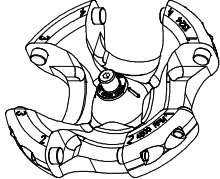

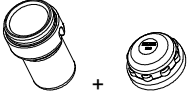

















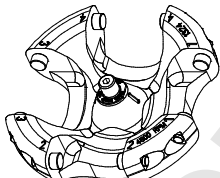

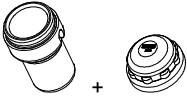





Il simbolo della pattumiera cancellata con una croce indica che l'apparecchio non deve essere smaltito con i rifiuti domestici.

Le norme per lo smaltimento possono essere differenti nei singoli paesi UE. In caso di necessità rivolgersi al proprio rivenditore.

31 Anhang / Appendix



31.1 Rotoren und Zubehör / Rotors and accessories



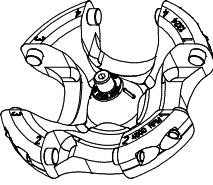
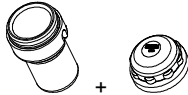

1324		1490 + 1492								
Ausschwingrotor 4-fach / Swing out rotor 4-times  		 +								
		mit Bioabdichtung / with bio-containment 5)								
		0761	0765		1329			1329	1330	
										
0526	0534 4)	0535	0500	0507				0519		
										
Kapazität / capacity	ml	100	30		9	15	7,5 - 8	9 - 10	10	25
Maße / dimensions $\varnothing \times L$	mm	44 x 100	44 x 105		14 x 100	17 x 100	15 x 92	16 x 92	15 x 102	24 x 100
Anzahl p. Rotor / number p. rotor		4	4		16	16	16		16	4
Drehzahl / speed	RPM	4000	4000		4000	4000	4000		4000	4000
RZB / RCF	³⁾	2522	2504		2504	2504	2504		2630	2397
Radius / radius	mm	141	140		140	140	140		147	134
 9 (97%)	sec	27								
 9	sec	30								
Probenerwärmung/Sample temp. rise	K ¹⁾	10								

1324		1490 + 1492								
Ausschwingrotor 4-fach / Swing out rotor 4-times  		 +								
		mit Bioabdichtung / with bio-containment 5)								
		1331	1339	1343	1347	1348				
										
0521	Rhesus			0509						
										
Kapazität / capacity	ml	50	1	3	4	15	10	8	8,5 - 10	4 - 7
Maße / dimensions $\varnothing \times L$	mm	34 x 100	6 x 45	10 x 60	10 x 88	17 x 120	16 x 80	16 x 81	16 x 100	16 x 75
Anzahl p. Rotor / number p. rotor		4	108	36		4	16	16	16	16
Drehzahl / speed	RPM	4000	4000	4000		4000	4000	4000	4000	4000
RZB / RCF	³⁾	2379	2558	2594		2630	2486	2486	2486	2486
Radius / radius	mm	133	143	145		147	139	139	139	139
 9 (97%)	sec	27								
 9	sec	30								
Probenerwärmung/Sample temp. rise	K ¹⁾	10								

- 1) Probenerwärmung bei maximaler Drehzahl und 1 Stunde Laufzeit (nur bei Zentrifuge ohne Kühlung)
 4) nicht mit Stopfen zentrifugierbar, Skal. 10µl-300µl, 15ml, 30ml
 5) Nach DIN EN 61010, Teil 2 – 020. Die Hinweise für Bio-Sicherheitssysteme in den Kapiteln "Sicherheitshinweise" und "Pflege und Wartung" beachten
 7) Die Einlagen entfernen
 3) Angaben des Röhrchenherstellers beachten.

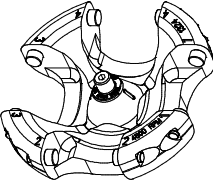









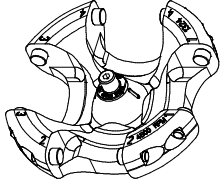
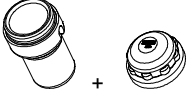

- 1) Sample temp. rise during maximum speed and 1 hour running time (only with centrifuges without cooling)
 4) can not be centrifugated when plug is attached, Scal. 10µl-300µl, 15ml, 30ml
 5) in conformity with DIN EN 61010, part 2 – 020. Observe the notes for bio safety systems in chapters "Notes on safety" and "Maintenance and servicing".
 7) Remove the inserts
 3) Observe the tube manufacturer's instructions.





1324		1490 + 1492										
Ausschwingrotor 4-fach / Swing out rotor 4-times  ∠ 90°		 mit Bioabdichtung / with bio-containment 5)										
		1329		1351		1363		1365		1383		
		0518		2078	0536					0533	0501	0578
Kapazität / capacity	ml	15	1,5	2,0	0,5	25	30	5	6	7	2,7 - 3	
Maße / dimensions	∅ x L mm	17 x 100	11 x 38	10,7 x 36	25 x 90	25 x 110	12 x 75	12 x 82	12 x 100	11 x 66		
Anzahl p. Rotor / number p. rotor		16	20	20	4	4	20	20	20			
Drehzahl / speed	RPM	4000	4000	4000	4000	4000	4000	4000	4000	4000		
RZB / RCF	³⁾	2504	2415	2343	2308	2630	2522	2522	2522	2522		
Radius / radius	mm	140	135	131	129	147	141	141	141	141		
 9 (97%)	sec	27										
 9	sec	30										
Probenerwärmung/Sample temp. rise	K ¹⁾	10										

1324		1490 + 1492							
Ausschwingrotor 4-fach / Swing out rotor 4-times  ∠ 90°		 mit Bioabdichtung / with bio-containment 5)							
		1383			1384		1396		
							0513	0547	0549
Kapazität / capacity	ml	2,6 – 3,4	4,9	4,5 - 5	1,6 -5	4 –7	50	85	85
Maße / dimensions	∅ x L mm	13 x 65	13 x 90	11 x 92	13 x 75	13 x 100	29 x 115	38 x 106	38 x 101
Anzahl p. Rotor / number p. rotor		20	20	20	20	20	4	4	4
Drehzahl / speed	RPM	4000	4000	4000	4000	4000	4000	4000	4000
RZB / RCF	³⁾	2522	2522	2522	2522	2522	2630	2576	2576
Radius / radius	mm	141	141	141	141	141	147	144	144
 9 (97%)	sec	27							
 9	sec	30							
Probenerwärmung/Sample temp. rise	K ¹⁾	10							

1) Probenerwärmung bei maximaler Drehzahl und 1 Stunde Laufzeit (nur bei Zentrifuge ohne Kühlung)
 5) Nach DIN EN 61010, Teil 2 – 020. Die Hinweise für Bio-Sicherheitssysteme in den Kapiteln "Sicherheitshinweise" und "Pflege und Wartung" beachten
 3) Angaben des Röhrchenherstellers beachten.

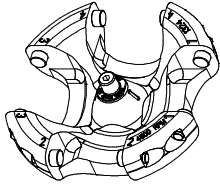
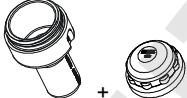

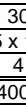
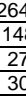







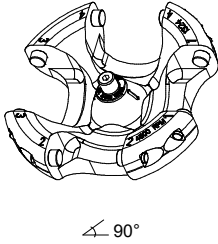



1) Sample temp. rise during maximum speed and 1 hour running time (only with centrifuges without cooling)
 5) in conformity with DIN EN 61010, part 2 – 020. Observe the notes for bio safety systems in chapters "Notes on safety" and "Maintenance and servicing".
 3) Observe the tube manufacturer's instructions.







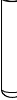



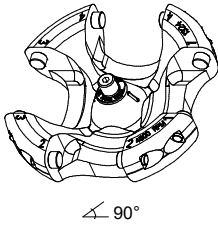

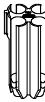



1324		1490 + 1492							
Ausschwingrotor 4-fach / Swing out rotor 4-times  $\angle 90^\circ$		 mit Bioabdichtung / with bio-containment ⁵⁾							
		1459	4416	4417	6311	6318	1356	1457	
									
				0546	0545	---	Falcon®	0509	
Kapazität / capacity	ml	4 – 5,5	7,5 – 8,5	50	30	12	50	15	1,1 – 1,4
Maße / dimensions $\varnothing \times L$	mm	15 x 75	15 x 92	29 x 107	26 x 95	17 x 100	29 x 115	17 x 120	8 x 66
Anzahl p. Rotor / number p. rotor		16	16	4	4	4	4	12	28
Drehzahl / speed	RPM	4000	4000	4000	4000	4000	4000	4000	4000
RZB / RCF	³⁾	2540	2540	2594	2415	2630	2630	2630	2540
Radius / radius	mm	142	142	145	135	147	147	147	142
 9 (97%)	sec	27							
 9	sec	30							
Probenerwärmung/Sample temp. rise	K ¹⁾	10							

1324		1491 / 1493 + 1492 / 1497					
Ausschwingrotor 4-fach / Swing out rotor 4-times  $\angle 90^\circ$		 mit Bioabdichtung / with bio-containment ⁵⁾					
							
							
							
Kapazität / capacity	ml	30					
Maße / dimensions $\varnothing \times L$	mm	25 x 110					
Anzahl p. Rotor / number p. rotor		4					
Drehzahl / speed	RPM	4000					
RZB / RCF	³⁾	2647					
Radius / radius	mm	148					
 9 (97%)	sec	27					
 9	sec	30					
Probenerwärmung/Sample temp. rise	K ¹⁾	10					

1) Probenerwärmung bei maximaler Drehzahl und 1 Stunde Laufzeit (nur bei Zentrifuge ohne Kühlung)
 5) Nach DIN EN 61010, Teil 2 – 020. Die Hinweise für Bio-Sicherheitssysteme in den Kapiteln "Sicherheitshinweise" und "Pflege und Wartung" beachten
 3) Angaben des Röhrchenherstellers beachten.









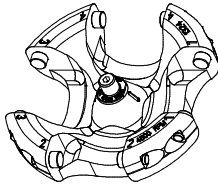

1) Sample temp. rise during maximum speed and 1 hour running time (only with centrifuges without cooling)
 5) in conformity with DIN EN 61010, part 2 – 020. Observe the notes for bio safety systems in chapters "Notes on safety" and "Maintenance and servicing".
 3) Observe the tube manufacturer's instructions.

1324		1398								
Ausschwingrotor 4-fach / Swing out rotor 4-times  $\angle 90^\circ$										
		1482A								
		2 x 	2 x 							
								0500 	0507 	
Kapazität / capacity	ml	2,6 – 2,9	4 – 4,5	9 – 10	10	12	4 - 7	9	15	
Maße / dimensions	Ø x L	mm	13 x 65	15 x 75	16 x 92	15 x 102	17 x 100	16 x 75	14 x 100	17 x 100
Anzahl p. Rotor / number p. rotor			16	16	16	16	16	16	16	
Drehzahl / speed	RPM		4000	4000	4000	4000	4000	4000	4000	
RZB / RCF	³⁾		2272	2272	2522	2522	2397	2522	2522	
Radius / radius	mm		127	127	141	141	134	141	141	
 9 (97%)	sec	27								
 9	sec	30								
Probenerwärmung/Sample temp. rise	K ¹⁾	9								

1324		1398								
Ausschwingrotor 4-fach / Swing out rotor 4-times  $\angle 90^\circ$										
		1483A 	1484 ohne / without E2110-A 	1484 	1482A 	1486 				
		0509 	Falcon® 	0513 	0518 	0533 	0501 	0578 		
Kapazität / capacity	ml	15	50	50	15	5	6	7		
Maße / dimensions	Ø x L	mm	17 x 120	29 x 115	29 x 115	17 x 100	12 x 75	12 x 82	12 x 100	
Anzahl p. Rotor / number p. rotor			16	4	4	16	20	20	20	
Drehzahl / speed	RPM		4000	4000	4000	4000	4000	4000		
RZB / RCF	³⁾		2612	2576	2576	2522	2486	2486		
Radius / radius	mm		146	144	144	141	139	139		
 9 (97%)	sec	27								
 9	sec	30								
Probenerwärmung/Sample temp. rise	K ¹⁾	9								

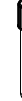









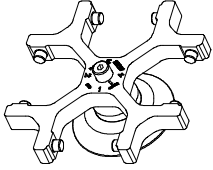

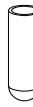
1) Probenerwärmung bei maximaler Drehzahl und 1 Stunde Laufzeit (nur bei Zentrifuge ohne Kühlung)
 3) Angaben des Röhrchenherstellers beachten.









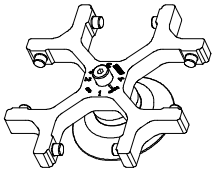

1) Sample temp. rise during maximum speed and 1 hour running time (only with centrifuges without cooling)
 3) Observe the tube manufacturer's instructions.

1324		1398						
Ausschwingrotor 4-fach / Swing out rotor 4-times  $\angle 90^\circ$								
		1486						
								
								
Kapazität / capacity	ml	2,6 – 3,4	2,7 – 3	4,5 - 5	4,9	1,6 -5	4 –7	
Maße / dimensions \varnothing x L	mm	13 x 65	11 x 66	11 x 92	13 x 90	13 x 75	13 x 100	
Anzahl p. Rotor / number p. rotor		20	20	20	20	20	20	
Drehzahl / speed	RPM	4000	4000	4000	4000	4000	4000	
RZB / RCF	³⁾	2486	2486	2486	2486	2486	2486	
Radius / radius	mm	139	139	139	139	139	139	
 9 (97%)	sec						27	
 9	sec						30	
Probenerwärmung/Sample temp. rise	K ¹⁾						9	

1) Probenerwärmung bei maximaler Drehzahl und 1 Stunde Laufzeit (nur bei Zentrifuge ohne Kühlung)
 3) Angaben des Röhrchenherstellers beachten.









1) Sample temp. rise during maximum speed and 1 hour running time (only with centrifuges without cooling)
 3) Observe the tube manufacturer's instructions.

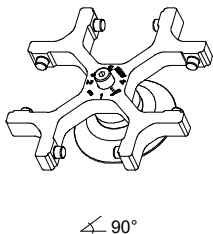
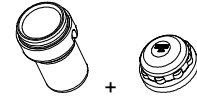





1624		1366								
Ausschwingrotor 4-fach / Swing out rotor 4-times  $\angle 90^\circ$	1308	1345	1346							
				1326	1327	1357	5277			
	0521					Rhe- sus		2078	0536	
										
Kapazität / capacity	ml	50	45	20	4	3	1	0,4	1,5	2,0
Maße / dimensions $\varnothing \times L$	mm	34 x 100	31 x 100	21 x 100	12 x 60	10 x 60	6 x 45		11 x 38	
Anzahl p. Rotor / number p. rotor		4	4	8	48	48	120		36	
Drehzahl / speed	RPM	4000	4000	4000	4000	4000	4000		4000	4000
RZB / RCF	³⁾	2290	2361	2361	1932	1932	1950		1968	1968
Radius / radius	mm	128	132	132	108	108	109		110	110
 (97%)	sec	22								
 1	sec	25								
Probenerwärmung/Sample temp. rise	K ¹⁾	10								

1624		1369			1369-92		1370	1372	1369-91
Ausschwingrotor 4-fach / Swing out rotor 4-times  $\angle 90^\circ$									
				mit Dekantierhilfe / with decanter aid					mit Dekantierhilfe / with decanter aid
	0507	0518		0501	0578	0500			
									
Kapazität / capacity	ml	15	15	8,5 - 10	6	7	9	5	5
Maße / dimensions $\varnothing \times L$	mm	17 x 100	17 x 100	16 x 100	12 x 82	12 x 100	14 x 100	12 x 75	12 x 75
Anzahl p. Rotor / number p. rotor		16	16	16	16	16	20	68	16
Drehzahl / speed	RPM	4000	4000	4000	4000	4000	4000	4000	4000
RZB / RCF	³⁾	2308	2308	2308	2343	2343	2308	2164	2218
Radius / radius	mm	129	129	129	131	131	129	121	124
 (97%)	sec	22							
 1	sec	25							
Probenerwärmung/Sample temp. rise	K ¹⁾	9							

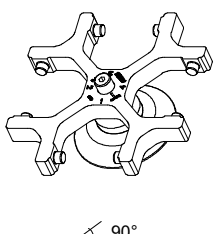
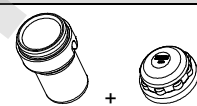
- 1) Probenerwärmung bei maximaler Drehzahl und 1 Stunde Laufzeit
 3) Angaben des Röhrchenherstellers beachten.











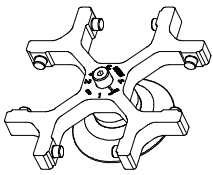

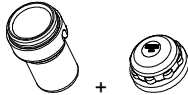

- 1) Sample temp. rise during maximum speed and 1 hour running time
 3) Observe the tube manufacturer's instructions.











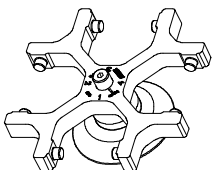







1624		1481 + 1492											
Ausschwingrotor 4-fach / Swing out rotor 4-times  $\angle 90^\circ$		 mit Bioabdichtung / with bio-containment ⁵⁾											
		1329		1330		1331		1339		1343		1347	
													
		0500	0507			0519	0521	Rhe- sus					0509
Kapazität / capacity		ml	9	15	7,5 - 8,5	9 - 10	25	50	1	0,4	3	4	15
Maße / dimensions $\varnothing \times L$		mm	14 x 100	17 x 100	15 x 92	16 x 92	24 x 100	34 x 100	6 x 45	10 x 60/	10 x 88	17 x 120	
Anzahl p. Rotor / number p. rotor			16	16	16	4	4	108	36	4	4	4	
Drehzahl / speed		RPM	4000	4000	4000	4000	4000	4000	4000	4000	4000	4000	4000
RZB / RCF		³⁾	2540	2540	2540	2433	2415	2594	2630	2665	2665	2665	2665
Radius / radius		mm	142	142	142	136	135	145	147	149	149	149	149
 (97%)		sec	22										
		sec	25										
Probenerwärmung/Sample temp. rise		K ¹⁾	10										

1624		1481 + 1492											
Ausschwingrotor 4-fach / Swing out rotor 4-times  $\angle 90^\circ$		 mit Bioabdichtung / with bio-containment ⁵⁾											
		1348				1351				1329		1329	
													
										2078	0536		0518
Kapazität / capacity		ml	10	8	4 - 7	8,5 - 10	0,5	1,5	2,0	10	15		
Maße / dimensions $\varnothing \times L$		mm	16 x 80	16 x 81	16 x 75	16 x 100	10,7 x 36	11 x 38	15 x 102	17 x 100			
Anzahl p. Rotor / number p. rotor			16	16	16	16	20	20	16	16			
Drehzahl / speed		RPM	4000	4000	4000	4000	4000	4000	4000	4000	4000	4000	
RZB / RCF		³⁾	2522	2522	2522	2522	2379	2451	2665	2540	2540	2540	
Radius / radius		mm	141	141	141	141	133	137	149	142	142	142	
 (97%)		sec	22										
		sec	25										
Probenerwärmung/Sample temp. rise		K ¹⁾	10										

1) Probenerwärmung bei maximaler Drehzahl und 1 Stunde Laufzeit
 5) Nach DIN EN 61010, Teil 2 – 020. Die Hinweise für Bio-Sicherheitssysteme in den Kapiteln "Sicherheitshinweise" und "Pflege und Wartung" beachten
 7) Die Einlagen entfernen
 3) Angaben des Röhrchenherstellers beachten.

1) Sample temp. rise during maximum speed and 1 hour running time
 5) in conformity with DIN EN 61010, part 2 – 020. Observe the notes for bio safety systems in chapters "Notes on safety" and "Maintenance and servicing".
 7) Remove the inserts
 3) Observe the tube manufacturer's instructions.

1624	1481 + 1492									
Ausschwingrotor 4-fach / Swing out rotor 4-times  	 mit Bioabdichtung / with bio-containment 5)									
	1383									
										
	0501									
										
Kapazität / capacity	ml	5	6	7	4,5 - 5,0	2,7 - 3	2,6 - 3,4	4,9	1,6 - 5,0	
Maße / dimensions	Ø x L	mm	12 x 75	12 x 82	12 x 100	11 x 92	11 x 66	13 x 65	13 x 90	13 x 75
Anzahl p. Rotor / number p. rotor		20	20	20	20	20	20	20	20	
Drehzahl / speed	RPM	4000	4000	4000	4000	4000	4000	4000	4000	
RZB / RCF	³⁾	2558	2558	2558	2558	2558	2558	2558	2558	
Radius / radius	mm	143	143	143	143	143	143	143	143	
 (97%)	sec	22								
 1	sec	25								
Probenerwärmung/Sample temp. rise	K ¹⁾	10								

1624	1481 + 1492							SK 13.06		
Ausschwingrotor 4-fach / Swing out rotor 4-times  	 mit Bioabdichtung / with bio-containment 5)									
	1383	1384	1396	6311	6318	1457				
										
	0513	0547	0549				0519			
										
Kapazität / capacity	ml	4 - 7	50	85	85	12	50	1,1 - 1,4	25	
Maße / dimensions	Ø x L	mm	13 x 100	29 x 115	38 x 106	38 x 101	17 x 100	29 x 115	8 x 66	24x 100
Anzahl p. Rotor / number p. rotor		20	4	4	4	4	4	28	8	
Drehzahl / speed	RPM	4000	4000	4000	4000	4000	4000	4000	4000	
RZB / RCF	³⁾	2558	2665	2612	2612	2665	2665	2576	2469	
Radius / radius	mm	143	149	146	146	149	149	144	138	
 (97%)	sec	22								
 1	sec	25								
Probenerwärmung/Sample temp. rise	K ¹⁾	10								

1) Probenerwärmung bei maximaler Drehzahl und 1 Stunde Laufzeit











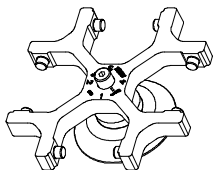
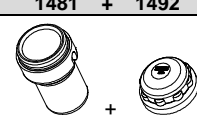



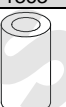

5) Nach DIN EN 61010, Teil 2 – 020. Die Hinweise für Bio-Sicherheitssysteme in den Kapiteln "Sicherheitshinweise" und "Pflege und Wartung" beachten



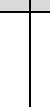







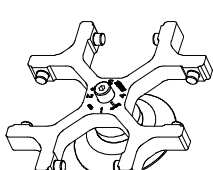





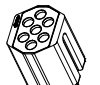







3) Angaben des Röhrchenherstellers beachten.

1) Sample temp. rise during maximum speed and 1 hour running time

5) in conformity with DIN EN 61010, part 2 – 020. Observe the notes for bio safety systems in chapters "Notes on safety" and "Maintenance and servicing".

3) Observe the tube manufacturer's instructions.

1624		1481 + 1492													
Ausschwingrotor 4-fach / Swing out rotor 4-times  $\leq 90^\circ$		 mit Bioabdichtung / with bio-containment 5)													
		1459		4416		4417		0761		0765		1363		1365	
															
				0546		0545		0526		0534 4)		0535			
															
Kapazität / capacity	ml	4 - 5,5	7,5 - 8,5	50	30	100	30	25	30						
Maße / dimensions $\varnothing \times L$	mm	15 x 75	15 x 92	29 x 107	26 x 95	44 x 100	44 x 105	25 x 90	25 x 110						
Anzahl p. Rotor / number p. rotor		16	16	4	4	4	4	4	4						
Drehzahl / speed	RPM	4000	4000	4000	4000	4000	4000	4000	4000						
RZB / RCF	3)	2576	2576	2630	2451	2558	2540	2343	2665						
Radius / radius	mm	144	144	147	137	143	142	131	149						
 (97%)	sec							22							
 1	sec							25							
Probenerwärmung/Sample temp. rise	K 1)							10							

1624		1741		1742		1745		1746		1741		1739		1742																			
Ausschwingrotor 4-fach / Swing out rotor 4-times  $\leq 90^\circ$																																	
		0701								0701				0716		0716																	
				---		---		---																									
				0500		0518 0507		0519 0545		0521																							
Kapazität / capacity	ml	9	15	25	30	50	4,9	1,1 - 1,4	4 - 7	1,6 - 5	4 - 7	4 - 5,5	2,6 - 3,4																				
Maße / dimensions $\varnothing \times L$	mm	14 x 100	17 x 100	24 x 100	26 x 95	34 x 100	13 x 90	8 x 66	13 x 100	13 x 75	16 x 75	15 x 75	13 x 65																				
Anzahl p. Rotor / number p. rotor		40	28	8	4	40	28	28	28																								
Drehzahl / speed	RPM	4000	4000	4000	4000	4000	4000	4000	4000	4000	4000	4000	4000																				
RZB / RCF	3)	2415	2451	2451	2451	2451	2451	2451	2415	2451	2325	2325																					
Radius / radius	mm	135	137	137	137	137	137	135	137	130	130	130																					
 (97%)	sec							22																									
 1	sec							25																									
Probenerwärmung/Sample temp. rise	K 1)							10																									

1) Probenerwärmung bei maximaler Drehzahl und 1 Stunde Laufzeit

4) nicht mit Stopfen zentrifugierbar, Skal. 10µl-300µl, 15ml, 30ml

5) Nach DIN EN 61010, Teil 2 – 020. Die Hinweise für Bio-Sicherheitssysteme in den Kapiteln "Sicherheitshinweise" und "Pflege und Wartung" beachten











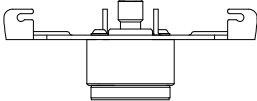



3) Angaben des Röhrchenherstellers beachten.











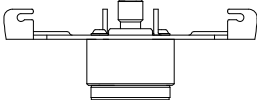

1) Sample temp. rise during maximum speed and 1 hour running time

4) can not be centrifugated when plug is attached, Scal. 10µl-300µl, 15ml, 30ml

5) in conformity with DIN EN 61010, part 2 – 020. Observe the notes for bio safety systems in chapters "Notes on safety" and "Maintenance and servicing".











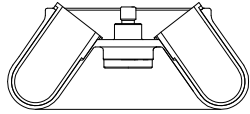
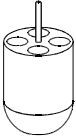

3) Observe the tube manufacturer's instructions.

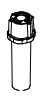
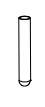

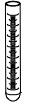







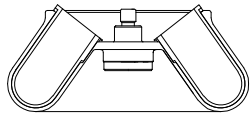

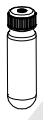

1611		1131					1132			
Ausschwingrotor 8-fach / Swing out rotor 8-times  										
		---	0501					2079		
										
Kapazität / capacity	ml	5	6	2,6 – 3,4	2,7 - 3	1,6 – 5,0	10	4,0 – 5,5	4 - 7	
Maße / dimensions	∅ x L	mm	12/13 x 75	12 x 82	13 x 65	11 x 66	13 x 75	17 x 70	15 x 75	16 x 75
Anzahl p. Rotor / number p. rotor			8	8	8	8	8	8	8	8
Drehzahl / speed	RPM		4000	4000	4000	4000	4000	4000	4000	4000
RZB / RCF		³⁾	1914	1914	1914	1914	1914	1914	1914	1914
Radius / radius	mm		107	107	107	107	107	107	107	107
 (97%)	sec						22			
 1	sec						25			
Probenerwärmung/Sample temp. rise	K ¹⁾						6			

1611		1643				1644				
Ausschwingrotor 8-fach / Swing out rotor 8-times  										
		0578		---		0518				
										
Kapazität / capacity	ml	7	4 – 7	10	4,5 - 5	15	7,5 – 8,2	8,5 - 10		
Maße / dimensions	∅ x L	mm	12 x 100	13 x 100	13 x 100	11 x 92	17 x 100	15 x 92	16 x 100	
Anzahl p. Rotor / number p. rotor			8	8	8	8	8	8		
Drehzahl / speed	RPM		4000	4000	4000	4000	4000	4000		
RZB / RCF		³⁾	2415	2415	2415	2415	2415	2415		
Radius / radius	mm		135	135	135	135	135	135		
 (97%)	sec						22			
 1	sec						25			
Probenerwärmung/Sample temp. rise	K ¹⁾						9			

- 1) Probenerwärmung bei maximaler Drehzahl und 1 Stunde Laufzeit
 3) Angaben des Röhrchenherstellers beachten.









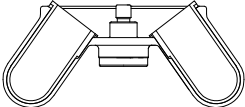

- 1) Sample temp. rise during maximum speed and 1 hour running time
 3) Observe the tube manufacturer's instructions.

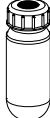









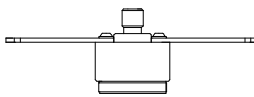

1620A	1449				1448	1451					
Winkelrotor 6-fach / Angle rotor 6-times  $\leq 35^\circ$											
	2078	0536	---			0518					
											
Kapazität / capacity	ml	1,5	2,0	0,5	3	10	15	9 - 10	7,5 - 8,5	8,5 - 10	10
Maße / dimensions $\varnothing \times L$	mm	11 x 38		10,7 x 36	10 x 60	16 x 80	17 x 100	16 x 92	15 x 92	16 x 100	15 x 102
Anzahl p. Rotor / number p. rotor		24		24		12	6	6	6	6	6
Drehzahl / speed	RPM	6000		6000		6000	6000	6000	6000	6000	6000
RZB / RCF	³⁾	4105		4105		3904	3904	3904	3904	3904	3904
Radius / radius	mm	102		102		97	97	97	97	97	97
 (97%)	sec						19				
 1	sec						22				
Probenerwärmung/Sample temp. rise	K ¹⁾						5				

1620A	1447	1446	1463		1466	1454	1646			
Winkelrotor 6-fach / Angle rotor 6-times  $\leq 35^\circ$							Falcon-Set für 6 Röhrchen / Falcon-set for 6 tubes			
	0545	0546	0548	0521	0509	0513	0513			
										
Kapazität / capacity	ml	30	50		75	50	15	50	50	
Maße / dimensions $\varnothing \times L$	mm	26 x 95	29 x 107		35 x 105	34 x 100	17 x 120	29 x 115	29 x 115	
Anzahl p. Rotor / number p. rotor		6	6		6	6	6	6	6	
Drehzahl / speed	RPM	6000	6000		6000	6000	6000	6000	6000	
RZB / RCF	³⁾	3824	4025		4146	4146	3985	3985	3985	
Radius / radius	mm	95	100		103	103	99	99	99	
 (97%)	sec						19			
 1	sec						22			
Probenerwärmung/Sample temp. rise	K ¹⁾						5			

- 1) Probenerwärmung bei maximaler Drehzahl und 1 Stunde Laufzeit
 3) Angaben des Röhrchenherstellers beachten.









- 1) Sample temp. rise during maximum speed and 1 hour running time
 3) Observe the tube manufacturer's instructions.

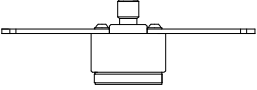





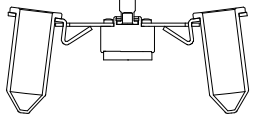
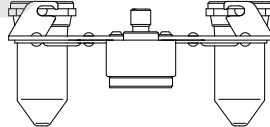

1620A		SK 63.98					
Winkelrotor 6-fach / Angle rotor 6-times  		0547	0549		0501		
							
Kapazität / capacity	ml	85	85	5	6	1,6 - 5	2,6 - 3,4
Maße / dimensions	Ø x L mm	38 x 106	38 x 106	12/13 x 75	12 x 82	13 x 75	13 x 65
Anzahl p. Rotor / number p. rotor		6	6	12	12	12	12
Drehzahl / speed	RPM	6000	6000	6000	6000	6000	6000
RZB / RCF	³⁾	4226	4226	3783	3783	3783	3783
Radius / radius	mm	105	105	94	94	94	94
 (97%)	sec					19	
 1	sec					22	
Probenerwärmung/Sample temp. rise	K ¹⁾					5	

1628		1122			1621		
Ausschwingrotor 12-fach / Swing out rotor 12-times   mit / with 1122  mit / with 1621							
		2079			0518		
							
Kapazität / capacity	ml	10	4 - 5,5	4 - 7	15	7,5 - 8,5	8,5 - 10
Maße / dimensions	Ø x L mm	17 x 70	15 x 75	16 x 75	17 x 100	15 x 92	16 x 100
Anzahl p. Rotor / number p. rotor		12	12	12	12	12	12
Drehzahl / speed	RPM	4000	4000	4000	4000	4000	4000
RZB / RCF	³⁾	2254	2254	2254	2683	2683	2683
Radius / radius	mm	126	126	126	150	150	150
 (97%)	sec					22	
 1	sec					25	
Probenerwärmung/Sample temp. rise	K ¹⁾					12	

- 1) Probenerwärmung bei maximaler Drehzahl und 1 Stunde Laufzeit
 3) Angaben des Röhrchenherstellers beachten.











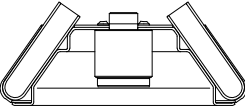

- 1) Sample temp. rise during maximum speed and 1 hour running time
 3) Observe the tube manufacturer's instructions.











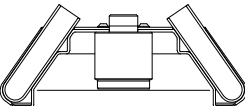
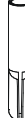

1628		1127						
Ausschwingrotor 12-fach / Swing out rotor 12-times  ∠ 55° mit / with 1127								
								
Kapazität / capacity	ml	5	1,6 – 5,0	2,6 – 3,4	2,7 – 3			
Maße / dimensions	∅ x L	mm	12 / 13 x 75	13 x 75	13 x 65	11 x 66		
Anzahl p. Rotor / number p. rotor		12	12	12	12			
Drehzahl / speed	RPM	4000	4000	4000	4000			
RZB / RCF	³⁾	2236	2236	2236	2236			
Radius / radius	mm	125	125	125	125			
 (97%)	sec	22						
 1	sec	25						
Probenerwärmung/Sample temp. rise	K ¹⁾	12						

1617				1619					
Ausschwingrotor 8-fach / Swing out rotor 8-times  ∠ 45°				Ausschwingrotor 6-fach / Swing out rotor 6-times  ∠ 90°		1681			
		1462-A				1462-A			
		0509	0513			0509	0513		
									
Kapazität / capacity	ml	15	50	Kapazität / capacity	ml	15	50		
Maße / dimensions	∅ x L	mm	17 x 120	29 x 115	Maße / dimensions	∅ x L	mm	17 x 120	29 x 115
Anzahl p. Rotor / number p. rotor		8	8	Anzahl p. Rotor / number p. rotor		6	6		
Drehzahl / speed	RPM	4000	4000	Drehzahl / speed	RPM	4000	4000		
RZB / RCF	³⁾	2469	2469	RZB / RCF	³⁾	2701	2701		
Radius / radius	mm	138	138	Radius / radius	mm	151	151		
 (97%)	sec	22		 (97%)	sec	22			
 1	sec	25		 1	sec	25			
Probenerwärmung/Sample temp. rise	K ¹⁾	11		Probenerwärmung/Sample temp. rise	K ¹⁾	10			

- 1) Probenerwärmung bei maximaler Drehzahl und 1 Stunde Laufzeit
- 3) Angaben des Röhrchenherstellers beachten.











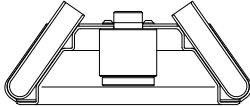



- 1) Sample temp. rise during maximum speed and 1 hour running time
- 3) Observe the tube manufacturer's instructions.











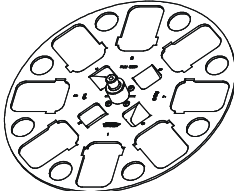



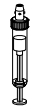

1613											
Winkelrotor 12-fach / Angle rotor 12-times  ∠ 35°											
		0518	0507		0509						
											
Kapazität / capacity	ml	15	15	12	15	4 - 7	4,9	4,5 - 5	7,5 - 8,5	9 - 10	
Maße / dimensions Ø x L	mm	17 x 100	17 x 100	17 x 102	17 x 120	13 x 100	13 x 90	11 x 92	15 x 92	16 x 92	
Anzahl p. Rotor / number p. rotor		12	12	6	6	12	12	12	12	12	
Drehzahl / speed	RPM	6000	6000	6000	6000	6000	6000	6000	6000	6000	
RZB / RCF	³⁾	4146	4146	4146	4146	4146	4146	4146	4146	4146	
Radius / radius	mm	103	103	103	103	103	103	103	103	103	
 (97%)	sec						13				
 1	sec						15				
Probenerwärmung/Sample temp. rise	K ¹⁾						5				

1613		1054-A									
Winkelrotor 12-fach / Angle rotor 12-times  ∠ 35°											
							0501				
											
Kapazität / capacity	ml	10	8	8,5 - 10	5	6	1,1 - 1,4	2,7 - 3	2,6 - 3,4		
Maße / dimensions Ø x L	mm	15 x 102	16 x 125	16 x 100	12/13 x 75	12 x 82	8 x 66	11 x 66	13 x 65		
Anzahl p. Rotor / number p. rotor		12	6	12	12	12	12	12	12		
Drehzahl / speed	RPM	6000	6000	6000	6000	6000	6000	6000	6000	6000	
RZB / RCF	³⁾	4146	4146	4146	3300	3300	3300	3300	3300	3300	
Radius / radius	mm	103	103	103	82	82	82	82	82	82	
 (97%)	sec						13				
 1	sec						15				
Probenerwärmung/Sample temp. rise	K ¹⁾						5				

- 1) Probenerwärmung bei maximaler Drehzahl und 1 Stunde Laufzeit
- 3) Angaben des Röhrchenherstellers beachten.











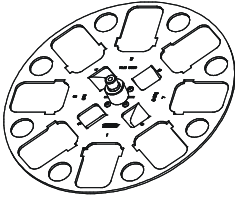

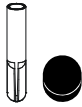
- 1) Sample temp. rise during maximum speed and 1 hour running time
- 3) Observe the tube manufacturer's instructions.











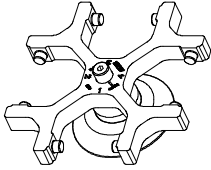

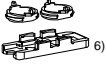
1613		1054-A	1054-A /0701					1063-6		
Winkelrotor 12-fach / Angle rotor 12-times  $\angle 35^\circ$				6305	SK 1/89	SK 19/85-4				
										
Kapazität / capacity	ml	1,6 - 5	4	4	0,8	4 - 5,5	4 - 7	0,5		
Maße / dimensions $\varnothing \times L$	mm	13 x 75	12 x 60	10 x 88	8 x 45	15 x 75	16 x 75	10,7 x 36		
Anzahl p. Rotor / number p. rotor		12	12	12	12	12	12	12		
Drehzahl / speed	RPM	6000	6000	6000	6000	6000	6000	6000		
RZB / RCF	³⁾	3300	3260	3502	2777	3663	3663	2777		
Radius / radius	mm	82	81	87	69	91	91	69		
 (97%)	sec								13	
 1	sec								15	
Probenerwärmung/Sample temp. rise	K ¹⁾								5	

1418		1467				1468					
Winkelrotor 8-fach / Angle rotor 8-times  $\angle 45^\circ$											
											
		0716	E2109		E2110-A						
		0507	0518	---		0509	0513	0546	---		
											
Kapazität / capacity	ml	15	15	12	9 - 10	15	50	50	50		
Maße / dimensions $\varnothing \times L$	mm	17 x 100	17 x 100	17 x 100	16 x 92	17 x 120	29 x 115	29 x 107	29 x 115		
Anzahl p. Rotor / number p. rotor		32	32	32	32	32	8	8	8		
Drehzahl / speed	RPM	4000	4000	4000	4000	4000	4000	4000	4000		
RZB / RCF	³⁾	2540	2540	2540	2594	2486	2486	2486	2486		
Radius / radius	mm	142	142	142	145	139	139	139	139		
 (97%)	sec						36				
 1	sec						43				
Probenerwärmung/Sample temp. rise	K ¹⁾						16				

- 1) Probenerwärmung bei maximaler Drehzahl und 1 Stunde Laufzeit
 3) Angaben des Röhrchenherstellers beachten.











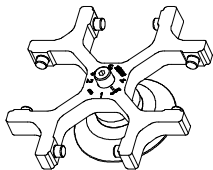
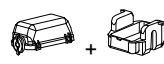

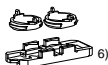
- 1) Sample temp. rise during maximum speed and 1 hour running time
 3) Observe the tube manufacturer's instructions.







1418		1467							
Winkelrotor 8-fach / Angle rotor 8-times  $\angle 45^\circ$									
	1054-A /0701		1054-A					+ 0716	
									
		0553							
									
Kapazität / capacity	ml	4	5	1,1 – 1,4	2,7 - 3	2,6 – 3,4	1,6 - 5	5	12
Maße / dimensions \varnothing x L	mm	12 x 60	12 x 75	8 x 66	11 x 66	13 x 65	13 x 75	13 x 75	17 x 102
Anzahl p. Rotor / number p. rotor		32	32	32	32	32	32	32	32
Drehzahl / speed	RPM	4000	4000	4000	4000	4000	4000	4000	4000
RZB / RCF	³⁾	2129	2182	2182	2182	2182	2182	2182	2540
Radius / radius	mm	119	122	122	122	122	122	122	142
 (97%)	sec	36							
 1	sec	43							
Probenerwärmung/Sample temp. rise	K ¹⁾	16							

1624		1661 + 1660							
Ausschwingrotor 4-fach / Swing out rotor 4-times  $\angle 90^\circ$									
	1662						1670		
									
	1663	1664	1665	1666	1667	1668	1663	1664	
									
Kapazität / capacity	ml	1	2	4	8	3 x 2	4 x 1	1	2
Maße / dimensions \varnothing / A	mm ²	6,2 / 30	8,7 / 60	12,4 / 120	17,5 / 240	8,7 / 60	6,2 / 30	6,2 / 30	8,7 / 60
Filterkarten / filter cards		1675	1675	1675	1676	1677	1678	1692	1692
Drehzahl / speed	RPM	4000	4000	4000	4000	4000	4000	4000	4000
RZB / RCF	³⁾	1646	1646	1646	1646	1646	1646	1646	1646
Radius / radius	mm	92	92	92	92	92	92	92	92
 (97%)	sec	22							
 1	sec	25							
Probenerwärmung/Sample temp. rise	K ¹⁾	10							

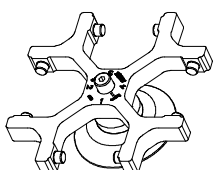
- 1) Probenerwärmung bei maximaler Drehzahl und 1 Stunde Laufzeit
 6) Objektträger nur belastbar bis RZB 1100
 3) Angaben des Röhrchenherstellers beachten.







- 1) Sample temp. rise during maximum speed and 1 hour running time
 6) Object slide will not stand RCF values exceeding 1100
 3) Observe the tube manufacturer's instructions.



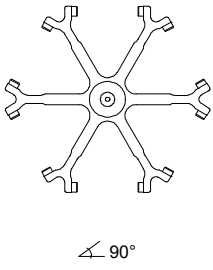
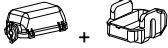

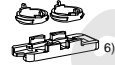



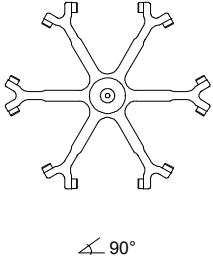

1624	1661 + 1660				1660	1680				
Ausschwingrotor 4-fach / Swing out rotor 4-times  $\angle 90^\circ$										
	1670 					1285  nur ohne Deckel / without lid 1661	1662 			
										
	1665	1666	1667	1668	1671	1672	1673			
Kapazität / capacity	ml	4	8	3 x 2	4 x 1	Objektträger/ object slide	[1] 0,5	[1] 0,5	[1] 0,5	
Maße / dimensions \varnothing / A	mm ²	12,4 / 120	17,5 / 240	8,7 / 60	6,2 / 30	26 / 76	6,2 / 30	8,7 / 60	12,4 / 120	
Anzahl p. Rotor / number p. rotor		8	8	8	8	24	4	4	4	
Filterkarten / filter cards		1692	1691	1694	1693		[1] 1696	[1] 1697	[1] 1698	
Drehzahl / speed	RPM	4000	4000	4000	4000	4000	4000	4000	4000	
RZB / RCF	³⁾	1646	1646	1646	1646	1574	1467	1467	1467	
Radius / radius	mm	92	92	92	92	88	82	82	82	
 (97%)	sec	22								
 1	sec	25								
Probenerwärmung/Sample temp. rise	K ¹⁾	10								

1624	1661 + 1660									
Ausschwingrotor 4-fach / Swing out rotor 4-times  $\angle 90^\circ$										
	1470 									
										
	1471	1475								
Kapazität / capacity	ml	1 x 8	2 x 8							
Maße / dimensions \varnothing / A	mm ²	17,5 / 240	17,5 / 240							
Anzahl p. Rotor / number p. rotor		4	4							
Filterkarten / filter cards		---	---							
Drehzahl / speed	RPM	4000	4000							
RZB / RCF	³⁾	1556	1556							
Radius / radius	mm	87	87							
 (97%)	sec	22								
 1	sec	25								
Probenerwärmung/Sample temp. rise	K ¹⁾	10								

- 1) Probenerwärmung bei maximaler Drehzahl und 1 Stunde Laufzeit
- 6) Objektträger nur belastbar bis RZB 1100
- [1] Einschritt-Methode
- 3) Angaben des Röhrchenherstellers beachten.









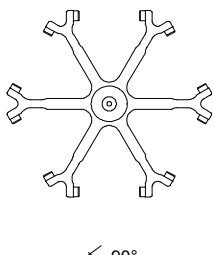
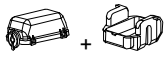

- 1) Sample temp. rise during maximum speed and 1 hour running time
- 6) Object slide will not stand RCF values exceeding 1100
- [1] One-step method
- 3) Observe the tube manufacturer's instructions.

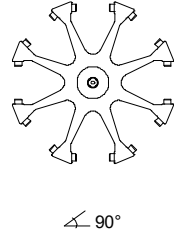
1626	1661 + 1660								
Ausschwingrotor 6-fach / Swing out rotor 6-times  $\angle 90^\circ$									
	1662				1670				
									
	1663	1664	1665	1666	1667	1668	1663	1664	
									
Kapazität / capacity	ml	1	2	4	8	3 x 2	4 x 1	1	2
Maße / dimensions \varnothing / A	mm ²	6,2 / 30	8,7 / 60	12,4 / 120	17,5 / 240	8,7 / 60	6,2 / 30	6,2 / 30	8,7 / 60
Anzahl p. Rotor / number p. rotor		6	6	6	6	6	6	12	12
Filterkarten / filter cards		1675	1675	1675	1676	1677	1678	1692	1692
Drehzahl / speed	RPM	4000	4000	4000	4000	4000	4000	4000	4000
RZB / RCF	³⁾	2039	2039	2039	2039	2039	2039	2039	2039
Radius / radius	mm	114	114	114	114	114	114	114	114
 (97%)	sec								22
 1	sec								25
Probenerwärmung/Sample temp. rise	K ¹⁾								8

1626	1661 + 1660				1660	1680				
Ausschwingrotor 6-fach / Swing out rotor 6-times  $\angle 90^\circ$										
	1670				1285		1662			
					 <small>nur ohne Deckel / without lid 1661</small>					
	1665	1666	1667	1668			1671	1672	1673	
										
Kapazität / capacity	ml	4	8	3 x 2	4 x 1	Objekträger/ object slide	[1] 0,5	[1] 0,5	[1] 0,5	
Maße / dimensions \varnothing / A	mm ²	12,4 / 120	17,5 / 240	8,7 / 60	6,2 / 30	26 / 76	6,2 / 30	8,7 / 60	12,4 / 120	
Anzahl p. Rotor / number p. rotor		12	12	12	12	36	6	6	6	
Filterkarten / filter cards		1692	1691	1694	1693		[1] 1696	[1] 1697	[1] 1698	
Drehzahl / speed	RPM	4000	4000	4000	4000	4000	4000	4000	4000	
RZB / RCF	³⁾	2039	2039	2039	2039	1950	1842	1842	1842	
Radius / radius	mm	114	114	114	114	109	103	103	103	
 (97%)	sec								22	
 1	sec								25	
Probenerwärmung/Sample temp. rise	K ¹⁾								8	









- 1) Probenerwärmung bei maximaler Drehzahl und 1 Stunde Laufzeit
- 6) Objekträger nur belastbar bis RZB 1100
- [1] Einschnitt-Methode
- 3) Angaben des Röhrchenherstellers beachten.

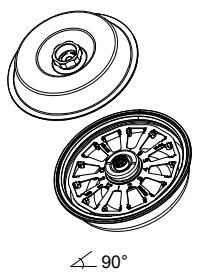

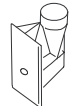
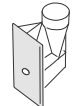
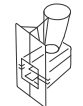
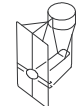



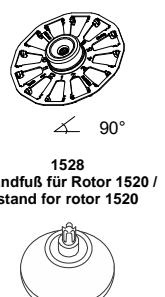
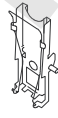
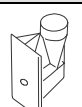

- 1) Sample temp. rise during maximum speed and 1 hour running time
- 6) Object slide will not stand RCF values exceeding 1100
- [1] One-step method
- 3) Observe the tube manufacturer's instructions.

1626		1661 + 1660		1648		1680		
Ausschwingrotor 6-fach / Swing out rotor 6-times 		 <hr/> 1470  <hr/> 1471 1475 		Ausschwingrotor 8-fach / Swing out rotor 8-times 		 <hr/> 1662  <hr/> 1671 1672 1673 		
Kapazität / capacity	ml	1 x 8	2 x 8	Kapazität / capacity	ml	[1] 0,5	[1] 0,5	[1] 0,5
Maße / dimensions Ø x L	mm	17,5 / 240	17,5 / 240	Maße / dimensions Ø x L	mm	6,2 / 30	8,7 / 60	12,4 / 120
Anzahl p. Rotor / number p. rotor		6	6	Anzahl p. Rotor / number p. rotor		8	8	8
Filterkarten / filter cards		---	---	Filterkarten / filter cards		[1] 1696	[1] 1697	[1] 1698
Drehzahl / speed	RPM	4000	4000	Drehzahl / speed	RPM	4000	4000	4000
RZB / RCF	³⁾	1950	1950	RZB / RCF	³⁾	2218	2218	2218
Radius / radius	mm	109	109	Radius / radius	mm	124	124	124
 (97%)	sec	22		 (97%)	sec	22		
 1	sec	25		 1	sec	28		
Probenerwärmung/Sample temp. rise	K ¹⁾	8		Probenerwärmung/Sample temp. rise	K ¹⁾	13		

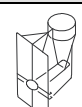
- 1) Probenerwärmung bei maximaler Drehzahl und 1 Stunde Laufzeit
- 6) Objektträger nur belastbar bis RZB 1100
- [1] Einschritt-Methode
- 3) Angaben des Röhrchenherstellers beachten.

- 1) Sample temp. rise during maximum speed and 1 hour running time
- 6) Object slide will not stand RCF values exceeding 1100
- [1] One-step method
- 3) Observe the tube manufacturer's instructions.

1515-A		1524						
<p>Rotor 12-fach</p>  <p>∠ 90°</p>								
		1531 / 1534 ¹²⁾	1532 ¹²⁾	1536 ¹²⁾	1538 ¹²⁾			
								
				1537 ¹²⁾	1539 ¹²⁾			
								
Kapazität / capacity	ml	0,5	0,2	6 ¹³⁾	0,5			
Maße / dimensions Ø / A	mm ²	6 / 28,3	6 / 28,3	-	6 / 28,3			
Maße (L x B) / dimensions (L x W)	mm	-	-	13,4 x 22	-			
Anzahl p. Rotor / number p. rotor		12						
Drehzahl / speed	RPM	2000						
RZB / RCF	³⁾	438						
Radius / radius	mm	98						
 9 (97%)	sec	19						
 9	sec	18						
Temperatur / temperature	°C ¹⁾	- 10						
Probenerwärmung/sample temp. rise	K ²⁾	3						

1520		1524						
<p>Rotor 12-fach</p>  <p>∠ 90°</p> <p>1528 Standfuß für Rotor 1520 / stand for rotor 1520</p>								
		1531 / 1534 ¹²⁾	1532 ¹²⁾	1536 ¹²⁾	1538 ¹²⁾			
								
				1537 ¹²⁾	1539 ¹²⁾			
								
Kapazität / capacity	ml	0,5	0,2	6 ¹³⁾	0,5			
Maße / dimensions Ø / A	mm ²	6 / 28,3	6 / 28,3	-	6 / 28,3			
Maße (L x B) / dimensions (L x W)	mm	-	-	13,4 x 22	-			
Anzahl p. Rotor / number p. rotor		12						
Drehzahl / speed	RPM	2000						
RZB / RCF	³⁾	438						
Radius / radius	mm	98						
 9 (97%)	sec	19						
 9	sec	18						
Temperatur / temperature	°C ¹⁾	- 10						
Probenerwärmung/sample temp. rise	K ²⁾	3						

- 1) Tiefste erreichbare Temperatur bei maximaler Drehzahl, 1 h Laufzeit und 20°C Raumtemperatur (nur bei Kühlzentrifuge)
 2) Probenerwärmung bei maximaler Drehzahl und 1 Stunde Laufzeit (nur bei Zentrifuge ohne Kühlung)

- 1) Lowest possible temperature during maximum speed, 1 h running time and 20°C ambient temperature (only with cooling centrifuges)
 2) Sample temp. rise during maximum speed and 1 hour running time (only with centrifuges without cooling)

12)	Bestell-Nr. / Cat. No.	Menge / Quantity	Bestell-Nr. / Cat. No.	Menge / Quantity
	1531, 1532	50 St. / 50 pcs.	1536, 1538	12 St. / 12 pcs.
	1534	500 St. / 500 pcs.	1539	200 St. / 200 pcs.
	1537	100 St. / 100 pcs.		

- 13) Dies ist das maximale Fassungsvermögen, die empfohlene Füllmenge der Kammern beträgt 4 ml.

- 13) This is the maximum capacity. The recommended quantity to be used per chamber is 4 ml.

- 3) Angaben des Röhrchenherstellers beachten.

- 3) Observe the tube manufacturer's instructions.