

Your **Power** for Health

greiner bio-one



Sapphire **PCR Consumables**

PCR At Its Best

Sapphire PCR Consumables

PCR At Its Best

Greiner Bio-One features its new PCR product line under the brand name Sapphire. The Sapphire PCR product portfolio comprises a full range of PCR reaction vessels and microplates for all major PCR applications.

Key Facts:

- Manufactured out of medical-grade polypropylene without interfering additives
- Thin-walled for efficient heat transfer during amplification
- Free of detectable DNase, RNase, human DNA, endotoxin and PCR inhibitors
- Suitable for real-time / quantitative PCR
- Comprehensive thermal cycler compatibility
- Packaging labelled with product symbols for easier identification and warehousing



Figure 1: Inner packaging for Sapphire PCR products and label with product drawing.

PCR Tubes (0.2 / 0.5 ml)

- With flat or domed cap or without cap
- Available in different colours (blue, red, green, yellow, purple and assorted)
- Frosted tube caps for easy labelling



Figure 2: 0.2 ml Sapphire PCR tubes with domed lid in different colours.

! **Free samples** of the new PCR products can be ordered on our website www.gbo.com or via e-mail to info@de.gbo.com.

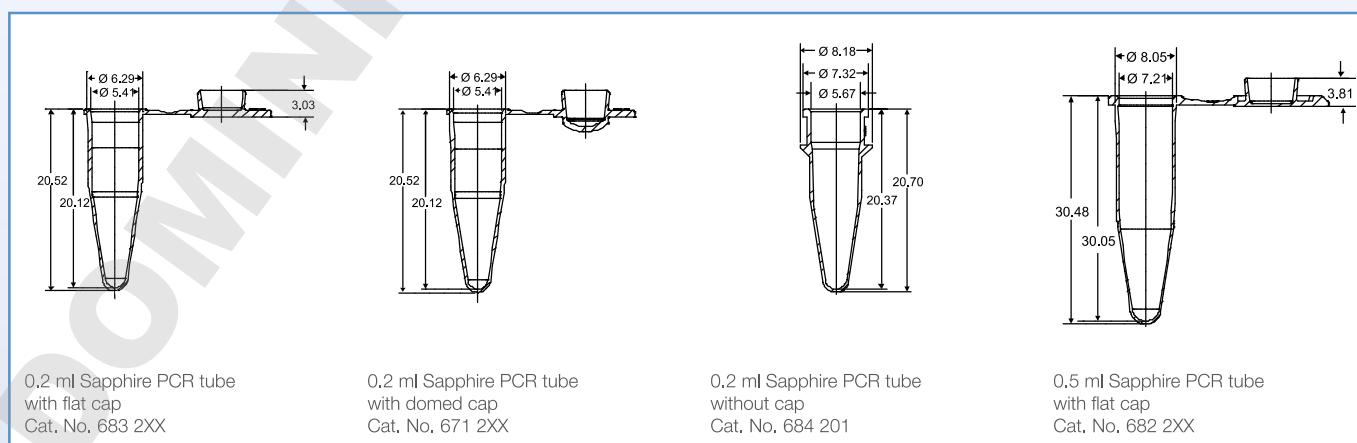

Figure 3: Dimensions of the Sapphire PCR tubes

Sapphire PCR Consumables

8-Tube Strips and 8-Cap Strips

Sapphire PCR 8-tube strips are especially beneficial for research applications as they allow improved sample handling when moderate sample numbers make the use of 96 well microplates inefficient. The Sapphire PCR 8-tube strips can be readily closed by the removable PCR 8-cap strips which are available in two versions, with domed lids for standard PCR or with flat lids for real-time PCR applications. Manufactured out of ultra-clear, virgin polypropylene the Sapphire PCR 8-cap strips guarantee reliable and reproducible PCR results (Figure 4).

8-Tube Strips (0.2 ml)

- Available in different colours (■ ■ ■ ■ ■ and assorted)
- Comprehensive thermal cycler compatibility
- Suitable for 8-cap strips

8-Cap Strips

- Flat ultra-clear 8-cap strips for real-time and quantitative PCR
- Domed 8-cap strips available in different colours (■ ■ ■ ■ ■ and assorted)

2 Fit All - For 8-Cap Strips

Both 8-cap strip versions are compatible with all Sapphire 96 well PCR microplates and Sapphire 8-tube strips.

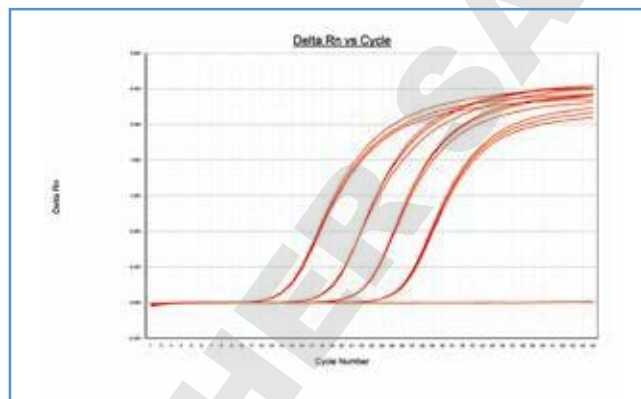

Figure 4: Real Time PCR in Sapphire 8-tube strips (cat. no. 673 210) closed with the appropriate Sapphire 8-cap strips with flat lid (cat. no. 373 250). Increase of fluorescence in dependence to cycle time and DNA concentration.

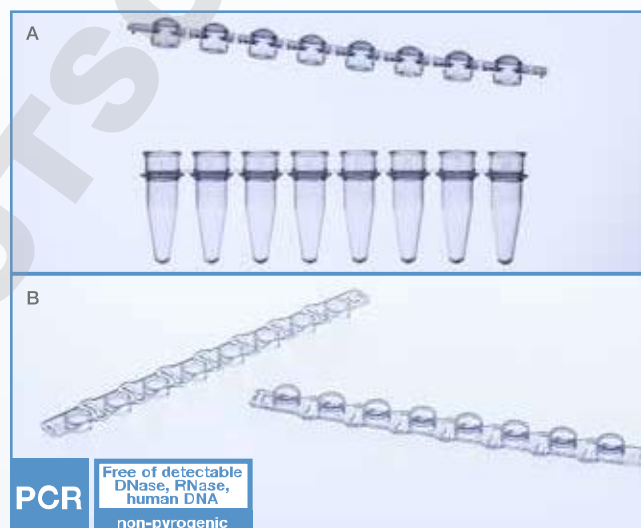

Figure 5: A) Sapphire 8-cap strips (domed) and Sapphire 8-tube strips B) Sapphire 8-cap strips (flat) for real-time PCR

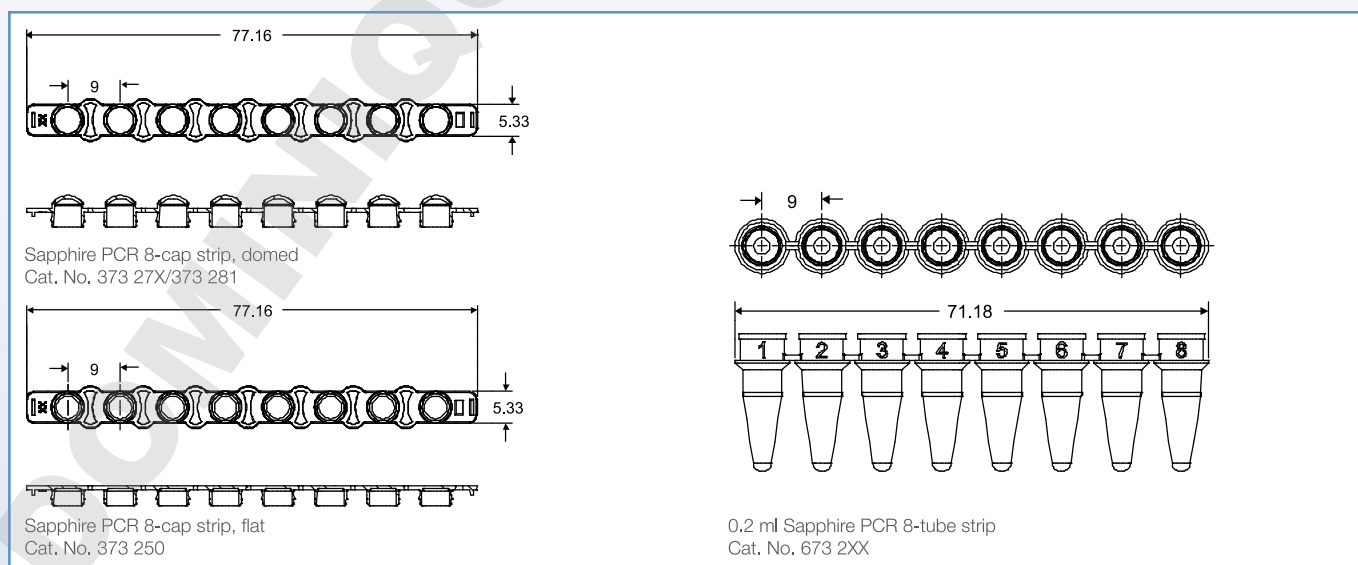

Figure 6: Dimensions of the Sapphire PCR 8-cap strips and 8-tube strips

Sapphire PCR Consumables

8-Tube Strips (0.2 ml) with individually attached caps

The classical Sapphire PCR 8-tube strips are now also available with individually attached caps.

The angular attached domed (Fig. 7A) or flat (Fig. 7B) caps can be closed and opened individually minimising the risk of cross contamination. Moreover, individual closing and opening helps to avoid pipetting errors and facilitates sample processing. The 8-tube strips can be split into smaller sections hence the number of required tubes can be adjusted to the sample number.

The 8-strip tubes are available with attached domed caps for standard PCR or with attached ultra clear flat cap for real-time PCR.

8-tube strips (0.2 ml) with individually attached domed caps for standard PCR:

- Manufactured out of medical-grade polypropylene without interfering additives
- Uniform thin walls for homogenous temperature transfer
- Universal fit for many PCR systems
- Combines single tube features with strip tube handling features
- Packed in stacks of 12 x 8-tube strips in a resealable bag
- Proven PCR quality (Free of DNase, RNase and human DNA, non-pyrogenic)

8-tube strips (0.2 ml) with individually attached flat caps for realtime PCR:

- Manufactured out of medical-grade polypropylene without interfering additives
- Uniform thin walls for homogenous temperature transfer
- Universal fit for many PCR systems
- Combines single tube features with strip tube handling features
- Packed in stacks of 12 x 8-tube strips in a resealable bag
- Proven PCR quality (Free of DNase, RNase and human DNA, non-pyrogenic)

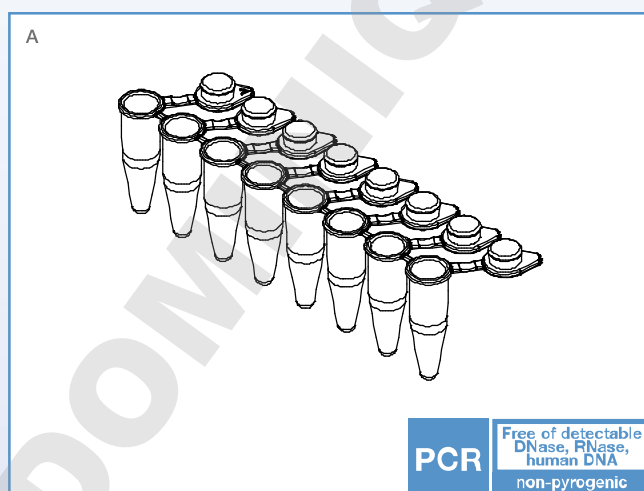
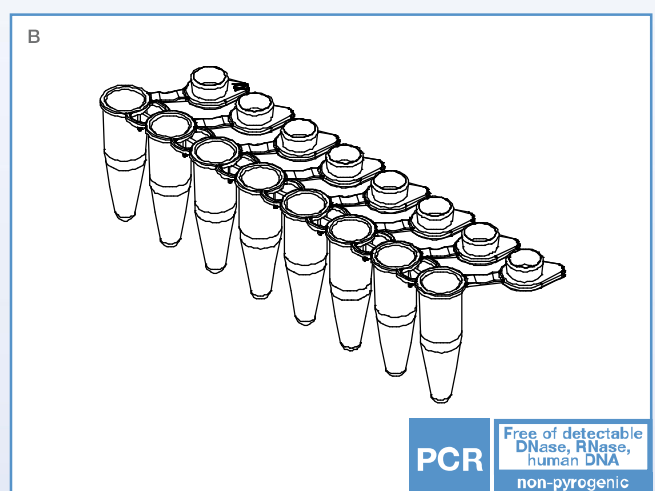

Figure 7:
A) 0.2 ml Sapphire PCR 8-Tube Strips with individually attached domed caps
Cat. No. 673 283



B) 0.2 ml Sapphire PCR 8-Tube Strips with individually attached flat caps
Cat. No. 608 281

Sapphire PCR Consumables

Low Profile 8-Tube Strips (0.1 ml) for FAST PCR

Sapphire PCR tubes are also available as low profile tubes ideal for FAST, standard and real-time PCR supporting the reduction of cycle time and sample volume without any compromises in accuracy and efficiency.

Sapphire PCR low-profile tubes provide a well volume of 0.1 ml. This leads to a reduced dead volume between sample and heated lid. The condensation on the walls of the PCR reaction tubes during PCR is minimised resulting in lower evaporation rates.

Sapphire PCR tubes are recommended for volumes below 20 µl and have a universal fit for many FAST, real-time and standard thermal cyclers. When used in FAST PCR, Sapphire PCR tubes help to reduce the cycle time.

Sapphire Low Profile PCR 8-tube strips with optically clear single attached flat caps for Realtime PCR

The 0.1 ml low profile 8-tube strips with angular attached flat caps allow individual closing and opening of the sample tubes reducing the risk of cross contamination. The solid interwell connections increase the rigidity of the strips reducing the risk of spillage. The flat optically clear caps ensure that fluorescence signals in real-time PCR pass through unaffected.



Figure 8: Fit of 0.1 ml low profile and 0.2 ml standard PCR tubes in an ABI 9700 PCR Thermal Cycler. The adjustable lid of the cycler allows the use of 0.1 ml low profile tubes. The reduced height of the low profile tubes minimises the gap between heated lid and reaction mix resulting in lower evaporation and higher accuracy of the polymerase chain reaction



Figure 9:
A) 0.1 ml Sapphire PCR Low Profile 8-Tube Strips with attached caps
Cat. No. 671 221

Key Facts:

- Optimal for FAST PCR
- Manufactured out of medical-grade polypropylene without interfering additives
- Thin-walled for homogenous temperature transfer
- Uniform wall thickness resulting in low evaporation rates
- Provides a universal fit for standard and FAST thermal cyclers
- Allows for reaction volumes below 20 µl saving reagents consumption
- Increased efficiency without compromises in accuracy
- Available with single flat lid attached or with ultra clear flat cap strips both allowing real-time PCR

Sapphire Low Profile PCR 8-tube strips, with optically clear flat 8-cap strips for Realtime PCR

The 0.1 ml low profile 8 tube strips with optically clear flat 8-cap strips allow easy and time saving closing and opening of the sample tubes. The flat optically clear caps ensure that fluorescence signals in real-time PCR pass through unaffected.

Tubes and cap strips come as real-time combo pack including 125 x 8-cap strips and 125 x 8-tube strips.

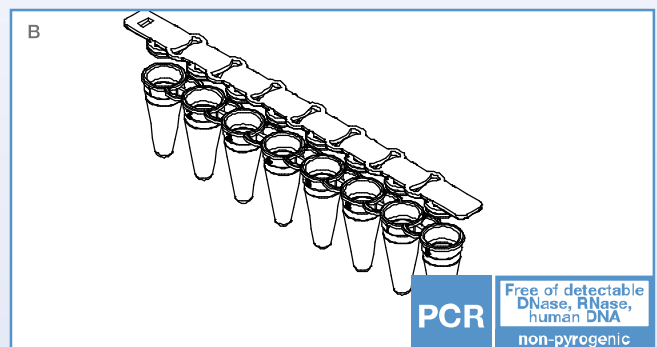

B) 0.1 ml Sapphire PCR Low Profile 8-Tube Strips with 8-Cap Strips
Cat. No. 673 281

Sapphire PCR Consumables

96 and 384 Well PCR Microplates

The Sapphire PCR product line includes a full range of 96 and 384 well PCR microplates including a new low profile universal fit 96 Well PCR microplate for FAST PCR applications.

Key Facts:

- 96 well without skirt, half-skirt and full-skirt
- Comprehensive thermal cycler compatibility
- Suitable for 8-cap strips, adhesive sealers and heat-sealing
- High-visibility alphanumeric printing for rapid sample identification
- Packaging labelled with product symbols for easier identification and warehousing

96 Well Low Profile Microplate

Sapphire PCR Microplates are now also available as low profile microplates for FAST, standard and realtime PCR supporting the reduction of cycle time and sample volume without any compromises in accuracy and efficiency.

The wells of the low profile microplate hold a well volume of 0.1 ml. This leads to a reduced dead volume between sample and heated lid. The condensation on the walls of the plate during PCR is minimised resulting in lower evaporation rates. The Sapphire PCR low profile microplate is recommended for volumes below 20 µl and has a universal fit for many FAST, realtime and standard thermal cyclers.

Key Facts:

- Black alphanumeric coding
- Chamfer on H12 position
- Universal fit (non-skirted / flat surface suitable for adhesive sealers)
- Suitable 8-tube strip caps cat. no. 373 250

96 Well PCR Microplates without skirt

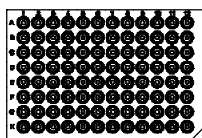

96 well Sapphire PCR microplate without skirt (652 201)

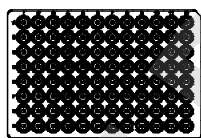

96 well Sapphire PCR microplate without skirt, flat, universal (652 250)

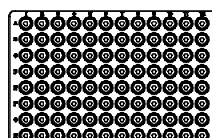

96 well Sapphire PCR microplate without skirt, low-profile (652 210)

96 Well PCR Half-Skirt and Full-Skirt Microplates

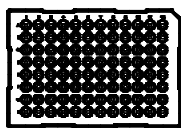

96 well Sapphire PCR microplate half-skirt, ABI design (652 260)

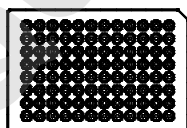

96 well Sapphire PCR microplate half-skirt, suitable for ABI (652 290)

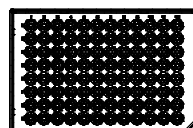

96 well Sapphire PCR microplate half-skirt, suitable for LightCycler® (669 285)

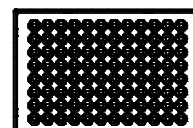

96 well Sapphire PCR microplate full-skirt (652 270)

384 Well PCR Microplates

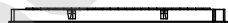
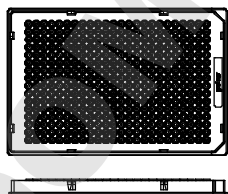

384 well Sapphire PCR microplate full-skirt (785 201)

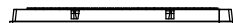
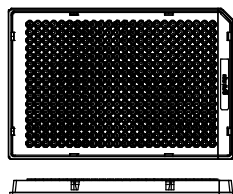

384 well Sapphire PCR microplate full-skirt, suitable for ABI (785 290)

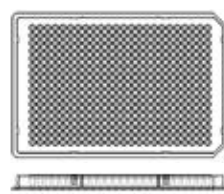

384 well Sapphire PCR microplate full-skirt, suitable for LightCycler® (785 285)

PCR Free of detectable DNase, RNase, human DNA non-pyrogenic

Figure 10: Dimensions of the 96 well and 384 well Sapphire PCR microplates

The registered trademarks of the mentioned manufacturers belong to the above mentioned companies.

Adhesive Sealers for PCR

Real-time PCR and various other methods for fluorescence measurements are common techniques in diagnostics, research and high throughput screening. As fluorescence detection is usually performed through lids, caps or other covers to prevent sample evaporation, the quality of the cover is essential for the quality of the measurement. Low background, homogeneous signal strength and reduced evaporation are the main prerequisites.

SILVERseal™

SILVERseal™ is an extremely robust, heat-resistant and pierceable aluminium film coated with a pressure-sensitive acrylate adhesive.

- Temperature-resistant from -80 °C to +110 °C
- Ideal for PCR applications
- Ideal for the storage of sample material and active agents
- Remains flat, when removed from its paper backing, and can thus be easily applied to all microplate types
- A double perforation makes it possible to tear off the projecting adhesive sealer and thus improves the stacking of sealed microplates

VIEWseal™

VIEWseal™ is a special highly transparent sealer with low autofluorescence for precise optical measurements. The pressure-sensitive silicone coating will only adhere where pressure is applied.

- Excellent optical clarity
- Air-tight sealing of microplates
- Reliable sealing during long-time storage
- Coated with silicone adhesive
- Easy to reseal
- Does not stick to finger or gloves
- Temperature-resistant from -70 °C to +100 °C



Figure 11: Adhesive sealers for PCR
A: SILVERseal™; B: VIEWseal™ (left) and AMPLIseal™ (right)

AMPLIseal™

AMPLIseal™ is a pressure-sensitive adhesive film that exhibits low autofluorescence, especially in the wavelength range important for real-time PCR. AMPLIseal™ is capable of sealing skirted and non-skirted PCR microplates as well as any other standard microplates. Consisting of a low autofluorescent polypropylene film, AMPLIseal™ is coated with a pressure-sensitive acrylate adhesive that is protected by a transparent polyester liner. Double-perforated sides enable elimination of unwanted sealer extensions beyond the plate surface. While the powerful adhesive force of AMPLIseal™ does not affect PCR reactions or fluorescence measurements, it guarantees a tight closure for the sealed microplate.

- Temperature resistant from -20 °C to +110 °C
- Low autofluorescence

Thermal Cycler Compatibility Guide

		Model	652 201 unskirted, chimney top	652 250 unskirted, universal	652 210 unskirted, low-profile	652 260 semi-skirted, ABI-Design	652 270 skirted	652 290 semi-skirted, suitable for ABI	669 285 semi-skirted, RT-PCR	785 201 skirted	785 285 skirted, RT-PCR	785 290 skirted, suitable for ABI	
			96 well						384 well				
Applied Biosystems	Thermal Cyclers	2700	•	•		•		•				•	
		2720				★						•	
		6100				★							
		9600	•	•		•		•					
		9700	•	•		★		•				★	
		Veriti 0.2 ml				★		★				•	
	Real Time Thermal Cyclers	5700		•		•							
		PRISM 7000		•		★		★					
		7300		•		★		★					
		7500		•		★		★					
		7700		•		•		★					
		7900HT		•		★							•
	Sequencers	ViiA 7				★							•
		Quant Studio 12K Flex				•							•
		PRISM 310	•	•		•		•					
		PRISM 3100	•	•		★		•					★
		3130 (XL)	•	•		★		★					★
		3700	•	•		★		★					★
Bio-Rad / MJ Research	Thermal Cyclers	PRISM 3730 (XL)	•	•		★		★				★	
		3500 (XL)				•						•	
		Gene Cycler	•	•		•							
		PTC-100	•	•	•		★	•					•
		PTC-200	•	•	•		★	•					•
		PTC-225 Tetrad	•	•	•		★	•					•
		Dyad/Dyad Disciple	•	•	•		★	•					•
		iCycler	•	•			•	★					
		MyCycler	•	•									
		Mini Gradient		•	•								
		Personal		•					•				
		T100		★				★					
	Real Time Thermal Cyclers	DNA Engine family		•	•			•	•		•		•
		C1000/S1000		•	★			•	•		•		•
		Opticon/Opticon2		•	•			★					
		Chromo-4			•			•					
		iCycler	•	•				•	★				
		MyiQ	•	•				•	★				
Sequencers	iQ5	•	•				•	★					
	CFX Connect			•			•	•					
	CFX96						★						
	CFX384									•		•	
	BaseStation						•						
	Mastercycler	•	•	•			•	•					
Eppendorf	Thermal Cyclers	Mastercycler ep Gradient	•	•		•	★	•					
		Mastercycler M384								•		•	
		Mastercycler Nexus		•	•			•	•				
		Mastercycler Nexus Gradient		•	•			★	•				
		Mastercycler Nexus Eco		•	•			•	•				
	Mastercycler Pro		•	•			•	•		•		•	
Real Time Thermal Cyclers	Mastercycler ep Realplex	•	•				★	•					

The registered trademarks of the mentioned manufacturers belong to the above mentioned companies. This compatibility chart is a general guide only and subject to error and modifications. We cannot accept any liability or responsibility for the above information.

Thermal Cycler Compatibility Guide

		Model	652 201 unskirted, chimney top	652 250 unskirted, universal	652 210 unskirted, low-profile	652 260 semi-skirted, ABI-Design	652 270 skirted	652 290 semi-skirted, suitable for ABI	669 285 semi-skirted, RT-PCR	785 201 skirted	785 285 skirted, RT-PCR	785 290 skirted, suitable for ABI	
			96 well						384 well				
Amers- ham	Sequencers	MegaBACE 500											
		MegaBACE 1000											
		MegaBACE 4000											
Beck- man	Sequencers	CEQ		•								•	
Biometra	Thermal Cyclers	Uno	•	•	•			•	•				
		Uno II	•	•	•			•	•			•	
		T1 Thermal Cycler	•	•	•			•	•				•
		Tgradient	•	•	•			•	•				•
		Trobot	•	•	•			•	•				•
		T3000		•	•			•	•				•
		T Professional		•	•			•	•				•
Cor- bett	Real Time Thermal Cyclers	Topical		•	•							•	
		Thermal Cyclers	PalmCycler 96										
Ericom	Thermal Cyclers	PalmCycler 384										•	
		Power Block I	•	•	•	•							
		Deltacycler I	•	•	•				•				
		Deltacycler II	•	•	•	•							
		Single Block	•	•	•								
Esco	Thermal Cyclers	Twin Block	•	•	•								
		Swift	•	•	•							•	
		Gene	•	•	•			•	•			•	
G-Storm	Thermal Cyclers	Genius	•	•	•			•	•				
		GS1	•	•	•	•			•				
		GS2	•	•	•	•			•				
		GS4	•	•	•	•			•				
		GSX	•	•	•	•			•				
MWG	Thermal Cyclers	GSXs	•	•	•	•			•				
		Primus 96	•	•	•			•	•				
Strate- gene	Thermal Cyclers	Primus 384										•	
		Robocycler 96		•									
	Real Time Thermal Cyclers	Robocycler Gradient	•	•	•	•			•				
Ta- Ka- Ra	Thermal Cyclers	Mx4000 and Mx3005P	•	•	•	•							
		TP240							•				
Techne	Thermal Cyclers	TP3000	•	•	•	•			•				
		Touchgene	•	•	•	•			•				
		Cyclogene	•	•	•	•			•				
		Genius	•	•	•	•			•				
		Genius Quad	•	•	•	•			•				
		Genius (TC412)	•	•	•	•			•				
		Flexigene	•	•	•	•			•				•
		Touchgene X		•	•	•	•			•			•
Thermo Hybaid	Real Time Thermal Cyclers	Touchgene Gradient (TC512)	•	•	•	•			•			•	
		Quantica			•			•					
		PCR Sprint	•	•	•	•			•				
		MBS Satellite (Multiblock)	•	•	•	•			•				
		Px2 and PxE	•	•	•	•			•				
Trans- geno- mic	Sequencers	PCR Express and Omni-E	•	•	•	•			•				
		Touchdown	•	•	•	•			•				
Ro- che	Real Time Thermal Cyclers	Omnigene	•	•	•	•			•				
		WAVE System						•					
Ro- che	Real Time Thermal Cyclers	LightCycler 96							•	•			
		Light Cycler 480							•	•	•	•	

The registered trademarks of the mentioned manufacturers belong to the above mentioned companies.

This compatibility chart is a general guide only and subject to error and modifications. We cannot accept any liability or responsibility for the above information.

Ordering Information

Cat. No.	Product Description	Pcs./Box	Pcs./Case	
PCR tubes (0.5 and 0.2 ml)				
0.5 ml	682 201	PCR tube, 0.5 ml, PP, natural , with attached frosted flat cap	1,000	10,000
	682 273	PCR tube, 0.5 ml, PP, red , with attached frosted flat cap	1,000	10,000
	682 274	PCR tube, 0.5 ml, PP, blue , with attached frosted flat cap	1,000	10,000
	682 275	PCR tube, 0.5 ml, PP, green , with attached frosted flat cap	1,000	10,000
	682 276	PCR tube, 0.5 ml, PP, yellow , with attached frosted flat cap	1,000	10,000
	682 277	PCR tube, 0.5 ml, PP, violet , with attached frosted flat cap	1,000	10,000
	682 281	PCR tube, 0.5 ml, PP, assorted , with attached frosted flat cap	1,000	10,000
0.2 ml	684 201	PCR tube, 0.2 ml, PP, natural , without cap	1,000	10,000
	683 201	PCR tube, 0.2 ml, PP, natural , with attached frosted flat cap	1,000	10,000
	683 273	PCR tube, 0.2 ml, PP, red , with attached frosted flat cap	1,000	10,000
	683 274	PCR tube, 0.2 ml, PP, blue , with attached frosted flat cap	1,000	10,000
	683 275	PCR tube, 0.2 ml, PP, green , with attached frosted flat cap	1,000	10,000
	683 276	PCR tube, 0.2 ml, PP, yellow , with attached frosted flat cap	1,000	10,000
	683 277	PCR tube, 0.2 ml, PP, violet , with attached frosted flat cap	1,000	10,000
	683 271	PCR tube, 0.2 ml, PP, assorted , with attached frosted flat cap	1,000	10,000
	671 201	PCR tube, 0.2 ml, PP, natural , with attached domed cap	1,000	10,000
	671 273	PCR tube, 0.2 ml, PP, red , with attached domed cap	1,000	10,000
	671 274	PCR tube, 0.2 ml, PP, blue , with attached domed cap	1,000	10,000
	671 275	PCR tube, 0.2 ml, PP, green , with attached domed cap	1,000	10,000
	671 276	PCR tube, 0.2 ml, PP, yellow , with attached domed cap	1,000	10,000
	671 277	PCR tube, 0.2 ml, PP, violet , with attached domed cap	1,000	10,000
	671 281	PCR tube, 0.2 ml, PP, assorted , with attached domed cap	1,000	10,000
	PCR 8-tube strips (0.2 ml)			
	0.2 ml	673 210	PCR 8-tube strip, 0.2 ml, PP, natural , without cap	125
673 273		PCR 8-tube strip, 0.2 ml, PP, red , without cap	125	1,250
673 274		PCR 8-tube strip, 0.2 ml, PP, blue , without cap	125	1,250
673 275		PCR 8-tube strip, 0.2 ml, PP, green , without cap	125	1,250
673 276		PCR 8-tube strip, 0.2 ml, PP, yellow , without cap	125	1,250
673 277		PCR 8-tube strip, 0.2 ml, PP, violet , without cap	125	1,250
673 271		PCR 8-tube strip, 0.2 ml, PP, assorted , without cap	125	1,250
PCR 8-tube strips with attached caps (0.1 ml / 0.2 ml)				
0.1/0.2	New 673 283	PCR 8-tube breakable strip, 0.2 ml, PP, natural , with individually attached domed caps	120	1,200
	New 608 281	PCR 8-tube strip for qPCR, 0.2 ml, PP, natural , with individually attached optical flat caps	120	1,200
	New 671 221	PCR 8-tube strip for qPCR, low profile, 0.1 ml, PP, natural , with individually attached optical flat caps	120	1,200
PCR 8-cap strips				
8-cap	373 250	PCR 8-cap strip, PP, natural , flat , for 673 2XX, for RT PCR	125	1,250
	373 270	PCR 8-cap strip, PP, natural , domed , for 673 2XX	125	1,250
	373 273	PCR 8-cap strip, PP, red , domed , for 673 2XX	125	1,250
	373 274	PCR 8-cap strip, PP, blue , domed , for 673 2XX	125	1,250
	373 275	PCR 8-cap strip, PP, green , domed , for 673 2XX	125	1,250
	373 276	PCR 8-cap strip, PP, yellow , domed , for 673 2XX	125	1,250
	373 277	PCR 8-cap strip, PP, violet , domed , for 673 2XX	125	1,250
	373 281	PCR 8-cap strip, PP, assorted , domed , for 673 2XX	125	1,250
PCR 8-tube strips with 8-cap strips (Combo Pack)				
New 673 281	PCR 8-tube strip for qPCR, low profile, 0.1 ml, PP, natural , with optical flat strip caps	125	1,250	

The registered trademarks of the mentioned manufacturers belong to the above mentioned companies.

Ordering Information

	Cat. No.	Product Description	Pcs./Box	Pcs./Case
PCR Microplates				
96 Well	652 201	PCR microplate, 96 well, PP, natural, without skirt	10	100
	652 250	PCR microplate, 96 well, PP, natural, without skirt, universal	10	100
	New 652 210	PCR microplate, 96 well, PP, natural, without skirt, low profile	20	100
	652 260	PCR microplate, 96 well, PP, natural, half-skirt, ABI design	10	100
	652 270	PCR microplate, 96 well, PP, natural, full-skirt	10	100
	652 290	PCR microplate, 96 well, PP, natural, half-skirt, suitable for ABI	10	100
	669 285	PCR microplate, 96 well, PP, white, half-skirt, for RT PCR, suitable for LightCycler	10	100
384 Well	785 201	PCR microplate, 384 well, PP, natural, full-skirt	15	60
	785 290	PCR microplate, 384 well, PP, natural, full-skirt, suitable for ABI	15	60
	785 285	PCR microplate, 384 well, PP, white, full-skirt, for RT PCR, suitable for LightCycler	25	100
Adhesive Sealers for PCR				
	676 040	AMPLIseal™, adhesive sealer, transparent, low autofluorescence, for RT PCR and HTS		100
	676 070	VIEWseal™, advanced adhesive sealer, transparent		100
	676 090	SILVERseal™, adhesive sealer, aluminium foil, pierceable		100

The registered trademarks of the mentioned manufacturers belong to the above mentioned companies.



For further information, please visit our website www.gbo.com/bioscience or contact us:

Germany (Main office)

Greiner Bio-One GmbH
Maybachstraße 2
D-72636 Frickenhausen
Phone (+49) 70 22 948-0
Fax (+49) 70 22 948-514
E-Mail info@de.gbo.com

Austria

Greiner Bio-One GmbH
Phone (+43) 75 83 67 91-0
Fax (+43) 75 83 63 18
E-Mail office@at.gbo.com

China

Greiner Bio-One GmbH
Phone (+86) 21 62 72 70 58
Fax (+86) 21 62 72 73 55
E-Mail info@cn.gbo.com

Netherlands

Greiner Bio-One B.V.
Phone (+31) 1 72 42 09 00
Fax (+31) 1 72 44 38 01
E-Mail info@nl.gbo.com

Belgium

Greiner Bio-One BVBA/SPRL
Phone (+32) 24 61 09 10
Fax (+32) 24 61 09 05
E-Mail info@be.gbo.com

France

Greiner Bio-One SAS
Phone (+33) 1 69 86 25 50
Fax (+33) 1 69 86 25 36
E-Mail infos@fr.gbo.com

UK

Greiner Bio-One Ltd.
Phone (+44) 14 53 82 52 55
Fax (+44) 14 53 82 62 66
E-Mail info@uk.gbo.com

Brazil

Greiner Bio-One Brasil
Phone (+55) 19 34 68 96 00
Fax (+55) 19 34 68 96 21
E-Mail office@br.gbo.com

Japan

Greiner Bio-One Co. Ltd.
Phone (+81) 3 35 05 88 75
Fax (+81) 3 35 05 89 74
E-Mail info@jp.gbo.com

USA

Greiner Bio-One North America Inc.
Phone (+1) 70 42 61 78 00
Fax (+1) 70 42 61 78 99
E-Mail info@us.gbo.com