



**Defender<sup>®</sup> 6000 Indicators  
Instruction Manual**

**Defender<sup>®</sup> 6000 Waagen  
Bedienungsanleitung**

**Indicadores Defender<sup>®</sup> 6000  
Manual de instrucciones**

**Manuel d'instructions sur les  
indicateurs de Defender<sup>®</sup> 6000**

**Indicatori<sup>®</sup> Defender 6000  
Manuale di istruzioni**



# Table of Contents

<b>1.</b>	<b>INTRODUCTION .....</b>	<b>3</b>
1.1.	SAFETY PRECAUTIONS .....	3
1.2.	INTENDED USE .....	3
1.3.	OVERVIEW OF PARTS AND CONTROLS .....	4
1.4.	MAINBOARD .....	5
1.5.	CONTROL FUNCTIONS .....	6
<b>2.</b>	<b>INSTALLATION .....</b>	<b>9</b>
2.1	UNPACKING .....	9
2.2	EXTERNAL CONNECTIONS.....	9
2.2.1	Scale Base with EasyConnect™ Connector.....	9
2.2.2	Power input to i-DT61PW.....	9
2.2.3	AC Power to i-DT61XWE.....	9
2.3	INTERNAL CONNECTIONS .....	9
2.3.1	Opening the Housing.....	9
2.3.2	Scale Base without EasyConnect™ Connector.....	11
2.3.3	Communication Interface Cable to i-DT61PW.....	14
2.3.4	RS232 Interface Cable to i-DT61XWE.....	15
2.4	MOUNTING BRACKET.....	15
<b>3.</b>	<b>OPERATION .....</b>	<b>16</b>
3.1	TURNING THE SCALE ON/OFF.....	16
3.2	WEIGHING MODE .....	16
3.2.1	Enter the Mode and Start Weighing .....	16
3.2.2	Accumulation and Statistics .....	16
3.2.3	Check .....	17
3.2.4	Application Settings .....	18
3.3	COUNTING MODE .....	19
3.3.1	Enter the Mode .....	19
3.3.2	Establish an APW .....	19
3.3.3	Start Counting .....	19
3.3.4	Application Settings .....	19
3.4	PERCENT MODE .....	20
3.4.1	Enter the Mode .....	20
3.4.2	Establish a Reference Weight.....	20
3.4.3	Start Percent Weighing .....	20
3.4.4	Application Settings .....	20
3.5	DYNAMIC MODE.....	21
3.5.1	Enter the Mode .....	21
3.5.2	Start Dynamic Weighing .....	21
3.5.3	Application Settings .....	21
3.6	FILLING MODE.....	22
3.6.1	Enter the Mode .....	22
3.6.2	Start Filling .....	22
3.6.3	Resume and Pause Filling.....	22
3.6.4	Display of the Dot Matrix Screen.....	22
3.6.5	Application Settings .....	23
<b>4.</b>	<b>MENU SETTINGS .....</b>	<b>24</b>
4.1	MENU NAVIGATION .....	24
4.1.1	User Menu.....	24
4.1.2	Button Navigation.....	25
4.2	CALIBRATION MENU.....	26
4.2.1	Initial Calibration.....	26
4.2.2	Zero Calibration [ZERR].....	26
4.2.3	Span Calibration [SPAN].....	26
4.2.4	Linearity Calibration [L #? ].....	27
4.2.5	GEO Adjustment [GEO].....	27
4.2.6	Calibration Test [L.E.S.E].....	28

4.2.7	<i>End Cal [End]</i> .....	28
4.3	SETUP MENU .....	29
4.4	READOUT MENU .....	33
4.5	UNIT MENU.....	35
4.6	GLP/GMP MENU .....	35
4.7	COMMUNICATION .....	36
4.7.1	<i>RS232 Menu</i> .....	36
4.7.2	<i>Print Menu</i> .....	37
4.7.3	<i>RS485 Configuration</i> .....	40
4.7.4	<i>Ethernet Configuration</i> .....	40
4.7.5	<i>Analog Configuration</i> .....	40
4.8	MEMORY .....	40
4.8.1	<i>Memory menu (for i-DT61PW model)</i> .....	40
4.8.2	<i>USB memory (for i-DT61XWE model)</i> .....	40
4.8.3	<i>Alibi Memory (for i-DT61XWE model)</i> .....	41
4.9	DISCRETE I/O (FOR I-DT61XWE MODEL) .....	46
4.9.1	<i>I/O Type</i> .....	46
4.9.2	<i>Input</i> .....	47
4.9.3	<i>Output</i> .....	47
4.10	LOCK KEY CONFIGURATION .....	47
4.11	LIBRARY (FOR I-DT61XWE MODEL).....	48
4.12	USER (FOR I-DT61XWE MODEL).....	50
4.13	USB (FOR I-DT61XWE MODEL) .....	52
4.13.1	<i>USB Flash Drive</i> .....	52
4.13.2	<i>RFID</i> .....	52
4.13.3	<i>Barcode</i> .....	52
4.13.4	<i>Keyboard</i> .....	52
4.13.5	<i>Wi-Fi/Bluetooth Dongle (Optional)</i> .....	53
<b>5.</b>	<b>LEGAL FOR TRADE</b> .....	<b>55</b>
5.1	SETTINGS.....	55
5.2	VERIFICATION .....	55
5.3	SEALING .....	55
<b>6.</b>	<b>MAINTENANCE</b> .....	<b>57</b>
6.1	CLEANING.....	57
6.1.1	<i>Cleaning for i-DT61PW Model</i> .....	57
6.1.2	<i>Cleaning for i-DT61XWE Model</i> .....	57
6.2	TROUBLESHOOTING .....	58
6.3	SERVICE INFORMATION .....	58
<b>7.</b>	<b>TECHNICAL DATA</b> .....	<b>59</b>
7.1	SPECIFICATIONS .....	59
7.2	TABLE OF GEO VALUES.....	61
<b>8.</b>	<b>COMPLIANCE</b> .....	<b>62</b>
<b>9.</b>	<b>APPENDICES</b> .....	<b>64</b>
9.1	APPENDIX A.....	64
9.2	APPENDIX B.....	66

# 1. INTRODUCTION

This manual contains installation, operation and maintenance instructions for i-DT61PW and i-DT61XWE indicators. Please read it completely before installation and operation.

## 1.1. Safety Precautions

### Definition of Signal Warnings and Symbols

Safety notes are marked with signal words and warning symbols. These show safety issues and warnings. Ignoring the safety notes may lead to personal injury, damage to the instrument, malfunctions and false results.

WARNING	For a hazardous situation with medium risk, possibly resulting in severe injuries or death if not avoided.
CAUTION	For a hazardous situation with low risk, resulting in damage to the device or the property or in loss of data, or minor or medium injuries if not avoided.
ATTENTION	For important information about the product. May lead to equipment damage if not avoided.
NOTE	For useful information about the product.

### Warning Symbols



General hazard



Explosion hazard



Electrical shock hazard

### Safety Precautions



**CAUTION:** Read all safety warnings before installing, making connections, or servicing this equipment. Failure to comply with these warnings could result in personal injury and/or property damage. Retain all instructions for future reference.

- Before connecting power, verify that the AC adapter's input voltage range and plug type are compatible with the local AC mains power supply.
- Do not position the equipment such that it is difficult to reach the power connection.
- Only connect the power cord to a compatible grounded electrical outlet.
- Make sure that the power cord does not pose a potential obstacle or tripping hazard.
- Operate the equipment only under ambient conditions specified in these instructions.
- The equipment is for indoor use only.
- Do not operate the equipment in hazardous or unstable environments.
- Do not place the equipment upside down on the platform.
- Use only approved accessories and peripherals.
- Disconnect the equipment from the power supply when cleaning.
- Service should only be performed by authorized personnel.



**WARNING:** Never work in an environment subject to explosion hazards! The housing of the instrument is not gas tight. (Explosion hazard due to spark formation, corrosion caused by the ingress of gases).



**WARNING:** Electrical shock hazards exist within the housing. The housing should only be opened by authorized and qualified personnel. Remove all power connections to the unit before opening.

## 1.2. Intended Use

This instrument is intended for use in light industry. It must only be used for measuring the parameters described in these operating instructions. Any other type of use and operation beyond the limits of technical specifications, without written consent from OHAUS, is considered as not intended. This instrument complies with current industry standards and the recognized safety regulations; however, it can constitute a hazard in use. If the instrument is not used according to these operating instructions, the intended protection provided by the instrument may be impaired.

1.3. Overview of Parts and Controls

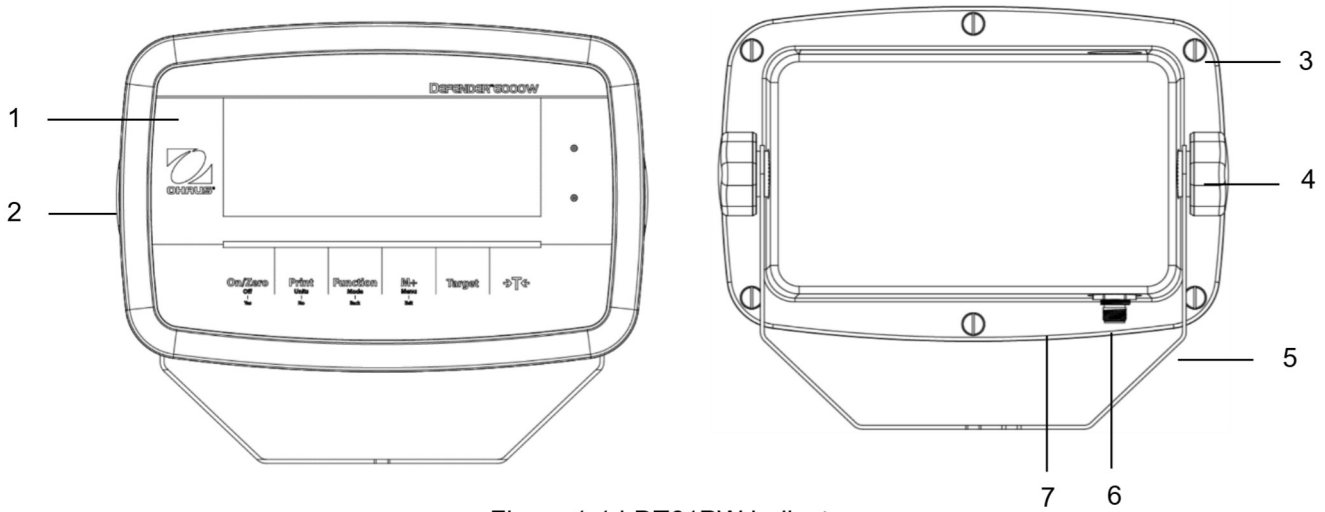

Figure 1-1 i-DT61PW Indicator

Item	Description
1	Control Panel
2	Front Housing
3	Screws (6)
4	Adjusting Knobs (2)
5	Mounting Bracket
6	Load Cell Connector
7	Rear Housing

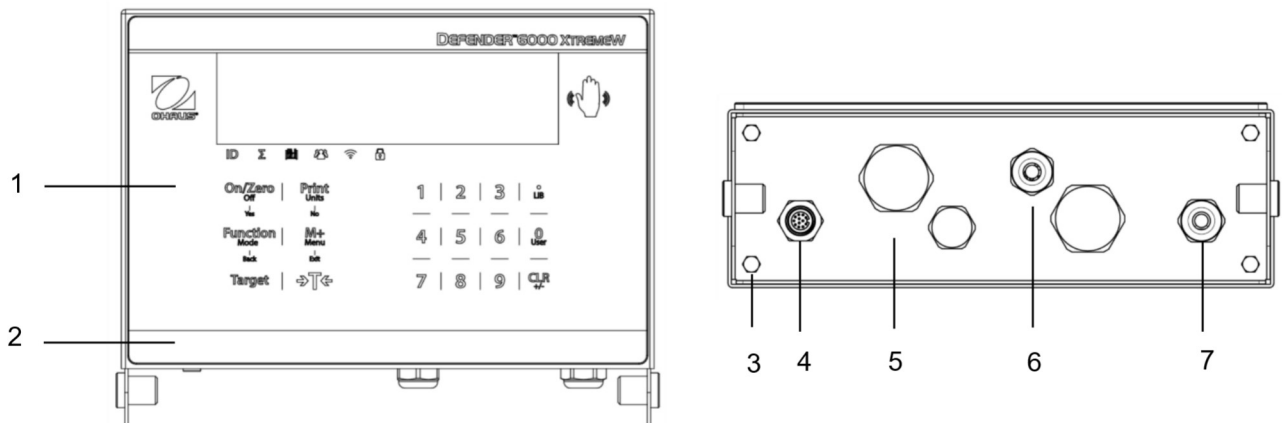
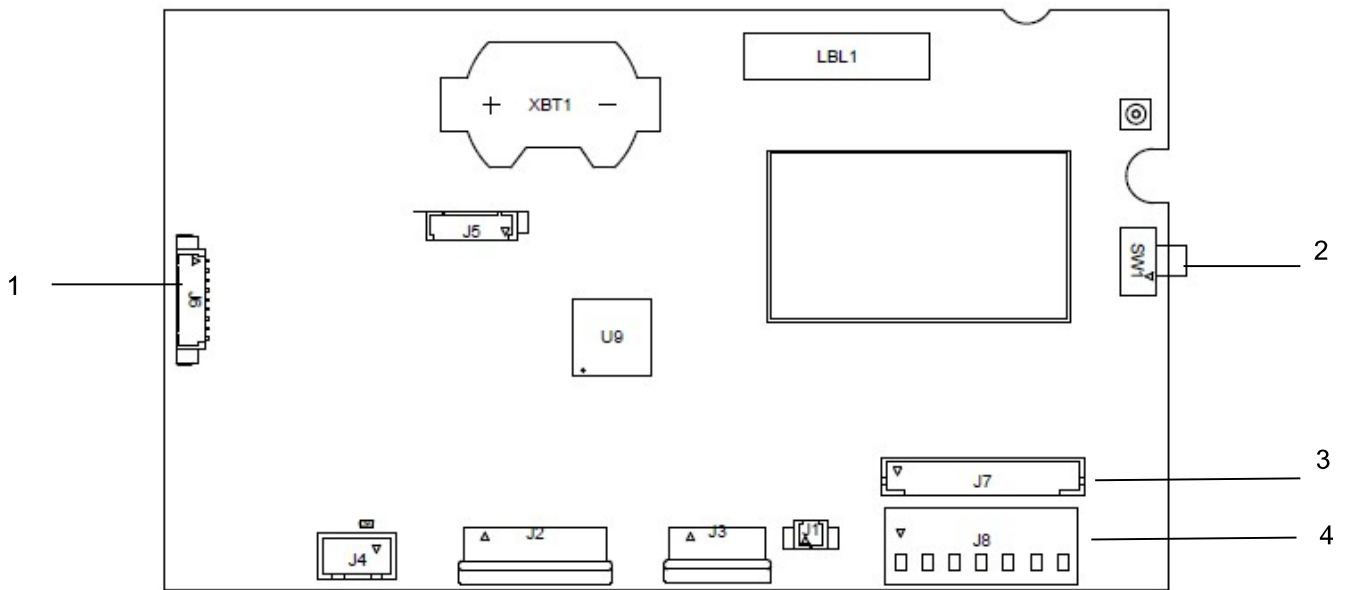

Figure 1-2 i-DT61XWE Indicator

Item	Description
1	Control Panel
2	Front Housing
3	Screws (4)
4	Load Cell Connector
5	Bottom Housing
6	Strain Relief for Option
7	Power cord

1.4. Mainboard



.Figure 1-3 i-DT61PW Mainboard

Item	Description
1	IR Communication connector (J6)
2	Security Switch (SW1)
3	Load Cell connector (J7)
4	Load Cell Terminal Block (J8)

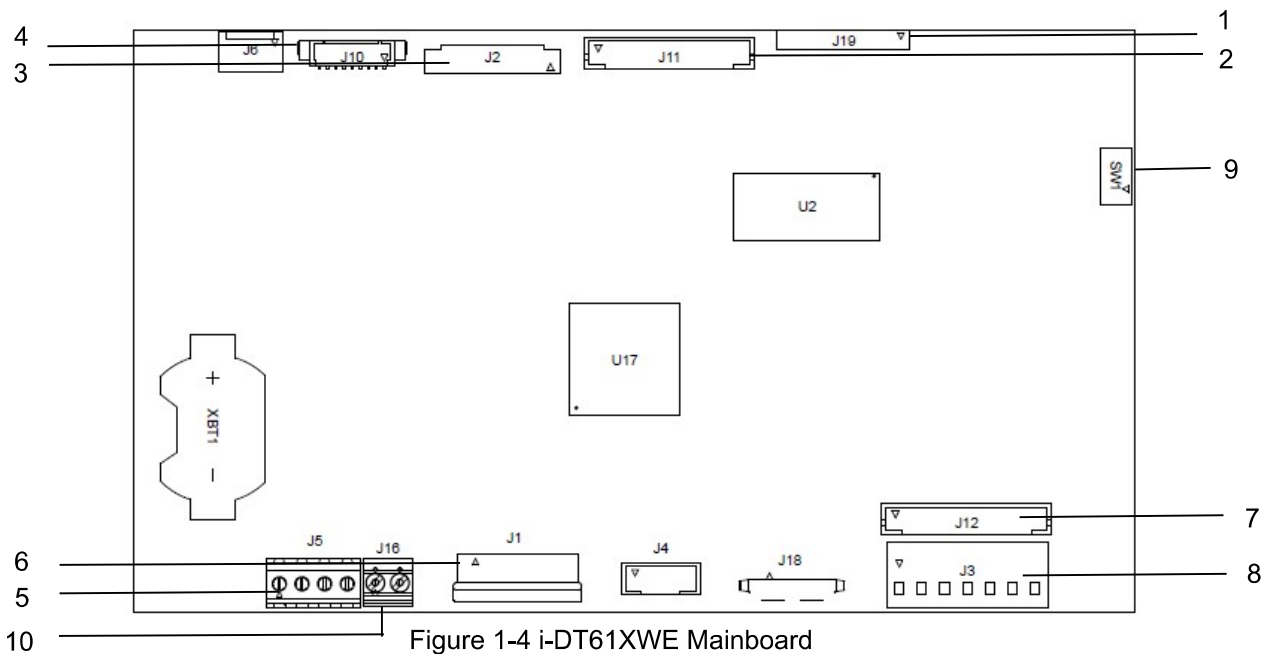

Figure 1-4 i-DT61XWE Mainboard

Item	Description	Item	Description
1	Alibi Memory Board connector (J19)	6	Keyboard connector (J1)
2	Discrete I/O/Analog/RS232-RS485-USB Device connector (J11)	7	Load Cell connector (J12)
3	Display Board connector (J2)	8	Load Cell Terminal Block (J3)
4	Ethernet connector (J10)	9	Security Switch connector (SW1)
5	RS232 connector (J5)	10	Discrete Input0 (J16)

### 1.5. Control Functions



i-DT61PW Control Panel



i-DT61XWE Control Panel

Button	On/Zero Off   Yes	Print Units   No	Function Mode   Back	M+ Menu   Exit	Target	→T←
Primary Function (Short Press)	<b>On/Zero</b> If the terminal is Off, press to power on;  If the terminal is On, press to set the zero point.	<b>Print</b> Sends the current value to the selected COM ports if AUTOPRINT is disabled.	<b>Function</b> Initiates an application mode.	<b>M+</b> Accumulates the weight or displays the accumulated information with no load on the pan.	<b>Target</b> Sets under/over limit value for Check.	<b>Tare</b> Enters/clears a tare value;  When the accumulation data is displayed, press to clear them.
Secondary Function (Long Press)	<b>Off</b> If the terminal is On, press to power off.	<b>Units</b> Changes the weighing unit.	<b>Mode</b> Allows changing the application mode.	<b>Menu</b> Enters the user menu.	<b>Target</b> Shows under/over limit value for Check.	<b>Tare</b> Displays the tare weight.
Menu Function (Short Press)	<b>Yes</b> Accepts the current setting on the display.	<b>No</b> Advances to the next menu or menu item.  Rejects the current setting on the display and advances to the next available one.	<b>Back</b> Moves back to the previous menu item.	<b>Exit</b> Exits the user menu.  Aborts the calibration in progress.		

**Notes:**

- Short Press: press less than 1 second.
- Long Press: press and hold for more than 2 seconds.



Numeric keyboard (i-DT61XWE)

Primary Function (Short Press)	<b>1-9</b> Enters numeric values.	<b>.</b> Enters decimal point (.).	<b>0</b> Enters numeric values 0.	<b>CLR</b> Clears the entered value. Clears an existing APW.  When the accumulation data is displayed, press to clear them.
Secondary Function (Long Press)		<b>LIB</b> Searches library items with numeric keys.	<b>User</b> Searches users with numeric keys.	<b>+/-</b> Switches between positive and negative values.

**Note:** for i-DT61XWE model, press the and button together for three seconds can lock all buttons. Perform the same procedure again to unlock all buttons. When all buttons are locked, the icon will be lighted.

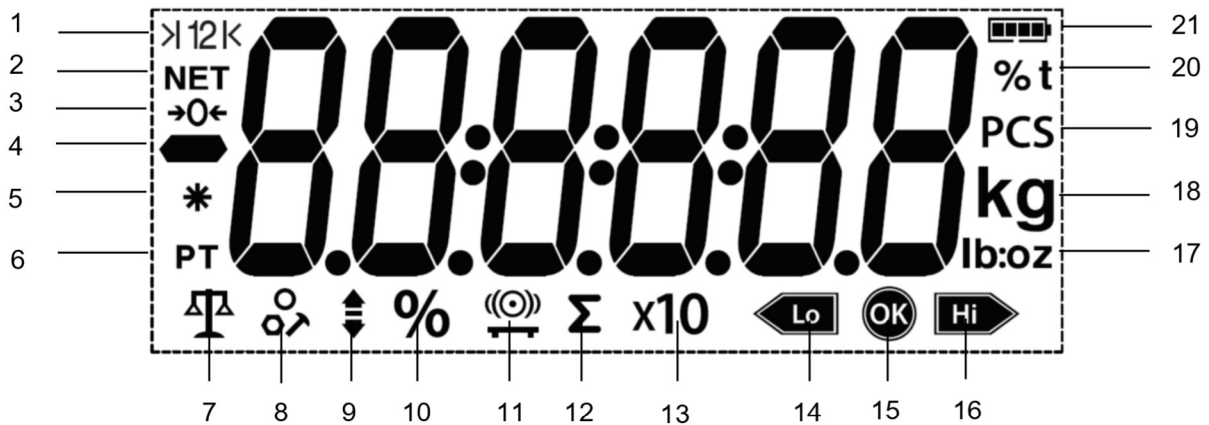

Figure 1-5 i-DT61PW Display

Item	Description	Item	Description
1	Range symbol (not used)	12	Accumulation symbol
2	NET symbol	13	Resolution extension symbol (not used)
3	Center of Zero symbol	14	Check weighing lower symbol
4	Negative symbol	15	Acceptable symbol
5	Stable weight symbol	16	Check weighing higher symbol
6	Preset Tare, Tare symbols	17	Pound, Ounce, Pound:Ounce symbols
7	Weighing mode symbol	18	Kilogram, gram symbols
8	Counting mode symbol	19	Pieces symbol
9	Check weighing mode symbol	20	Percent symbol, tonne symbol (not used)
10	Percentage weighing mode symbol	21	Battery symbol
11	Dynamic weighing mode symbol		

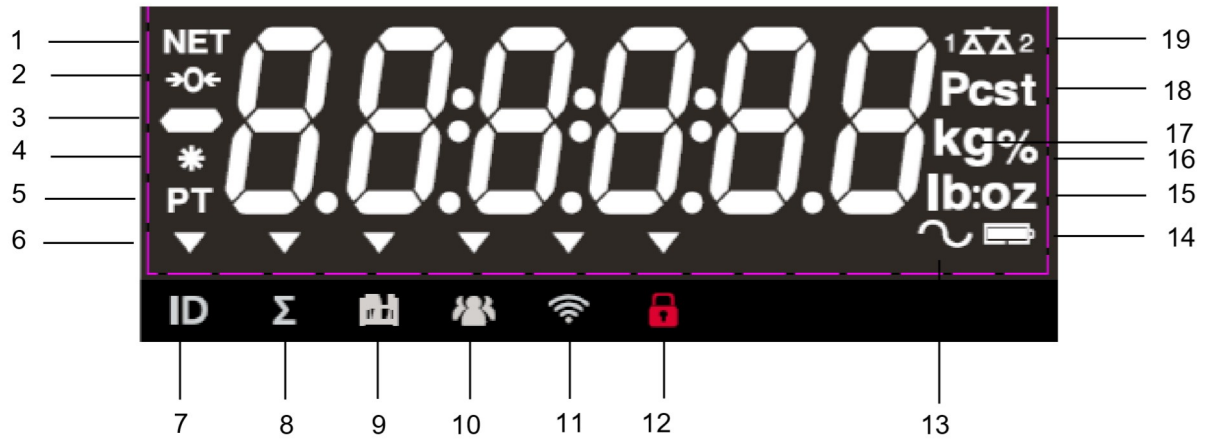

Figure 1-6 i-DT61XWE Display

Item	Description	Item	Description
1	NET symbol	11	Wi-Fi symbol
2	Center of Zero symbol	12	Lock symbol
3	Negative symbol	13	Dynamic (tilde) symbol
4	Stable weight symbol	14	Battery symbol (not use)
5	Preset Tare, Tare symbols	15	Pound, Ounce, Pound:Ounce symbols
6	Pointer symbols	16	Percent symbol
7	ID symbol	17	Kilogram, gram symbols
8	Accumulation symbol	18	Pieces symbol, tonne symbol (not used)
9	Library symbol	19	Scale symbol (not used)
10	User symbol		

## 2. INSTALLATION

### 2.1 Unpacking

Unpack the following items:

- i-DT61PW or i-DT61XWE indicator
- 6 cells of D size dry batteries (i-DT61PW only)
- Mounting bracket
- Knobs (2)
- Quick installation guide
- Instruction manual

### 2.2 External Connections

#### 2.2.1 Scale Base with EasyConnect™ Connector

To connect the OHAUS scale base with EasyConnect™ connector to the terminal, plug the base's connector onto the external load cell connector located at the bottom of the terminal. Then rotate the base connector's locking ring clockwise. Check the following illustration for details.

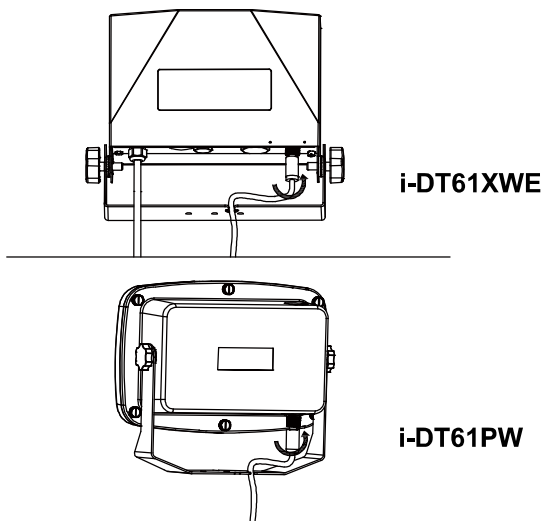

#### 2.2.2 Power input to i-DT61PW

Use 6 cells of D size dry batteries. During battery operation, the battery symbol indicates the battery status.



Battery 5%~25% remaining



Battery 25%~50% remaining



Battery 50%~75% remaining



Battery 75%~100% remaining

#### 2.2.3 AC Power to i-DT61XWE

Connect the AC plug to an electrical outlet.

### 2.3 Internal Connections

Some connections require the housing to be opened.

#### 2.3.1 Opening the Housing



**CAUTION: ELECTRICAL SHOCK HAZARD. REMOVE ALL POWER CONNECTIONS TO THE INDICATOR BEFORE SERVICING OR MAKING INTERNAL CONNECTIONS. THE HOUSING SHOULD ONLY BE OPENED BY AUTHORIZED AND QUALIFIED PERSONNEL, SUCH AS AN ELECTRICAL TECHNICIAN.**

##### i-DT61PW

1. Remove the six Phillips head screws from the rear housing.
2. Remove the front housing. Be careful not to disturb the internal connections.

3. Once all connections are made, re-attach the front housing.

#### **i-DT61XWE**

1. Remove the four hex head screws from the bottom housing.



2. Open the housing by carefully pulling the bottom housing backward.

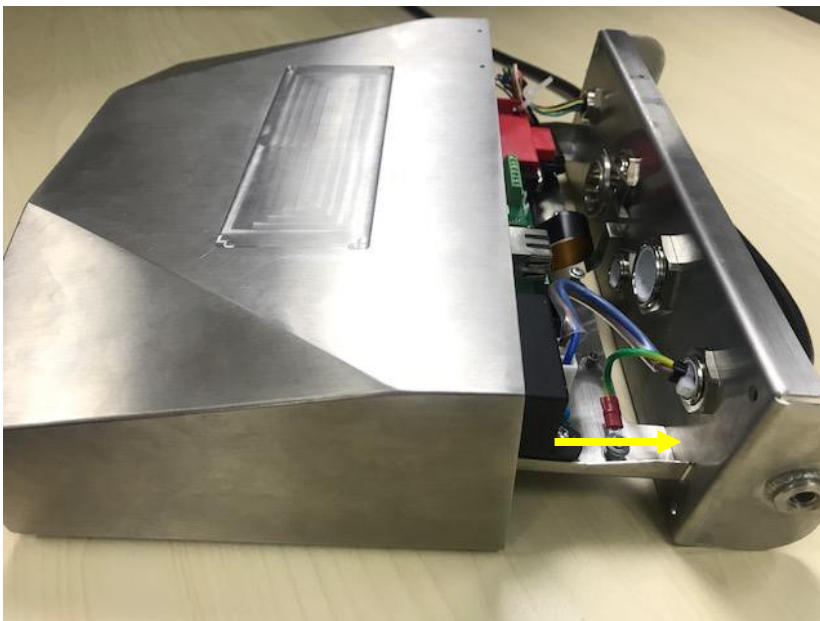

3. Once all connections are made, re-attach the bottom housing.

**Note:** The screws should be tightened to 2.5 N•m (20-25 in-lb) torque to ensure a watertight seal.

### 2.3.2 Scale Base without EasyConnect™ Connector

For connecting bases (which do not have the EasyConnect™ connector) to an i-DT61PW or an i-DT61XWE, a load cell cable gland kit (P/N 30379716) is available as an accessory.

#### Removing the pre-installed Load Cell connector and wiring harness.

Before making the connections, remove the pre-installed load cell connector and wiring harness by following the following steps.

##### i-DT61PW

1. Remove the 6 Phillips head screws, and open the rear housing by carefully pulling the front housing forward.
2. Unplug the white load cell connectors from the main housing (two circles).



3. Open the front housing by removing the 12 Phillips head screws.
4. Unplug the white load cell connectors from the main PCBA board.

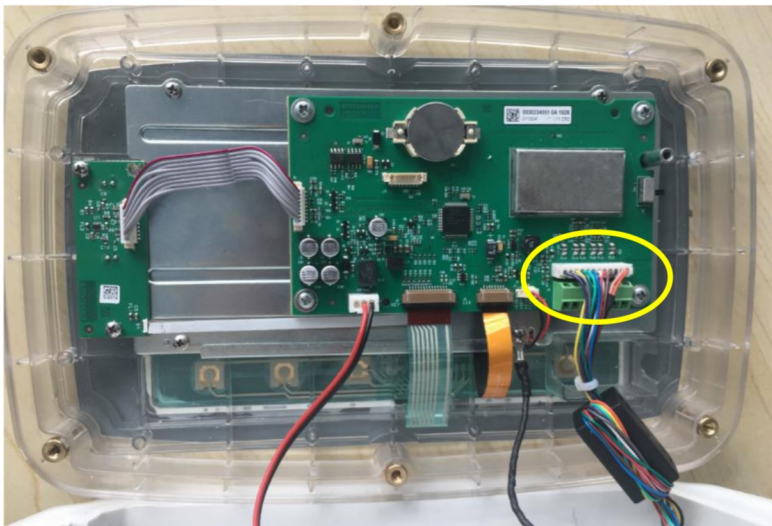

**i-DT61XWE**

1. Place the terminal down, and unscrew the screws marked in the following graphic.



2. Pull out the bottom of the terminal.

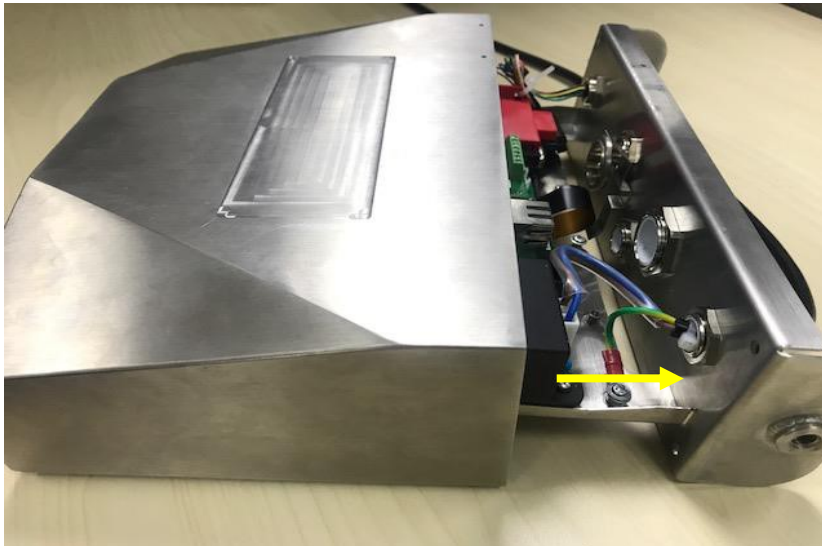

3. Use a screw driver to unscrew the sealing cover.



4. Pull the protruding part of the sealing cover a little forward to release it.



5. Remove the sealing cover and then unplug the white load cell connectors.

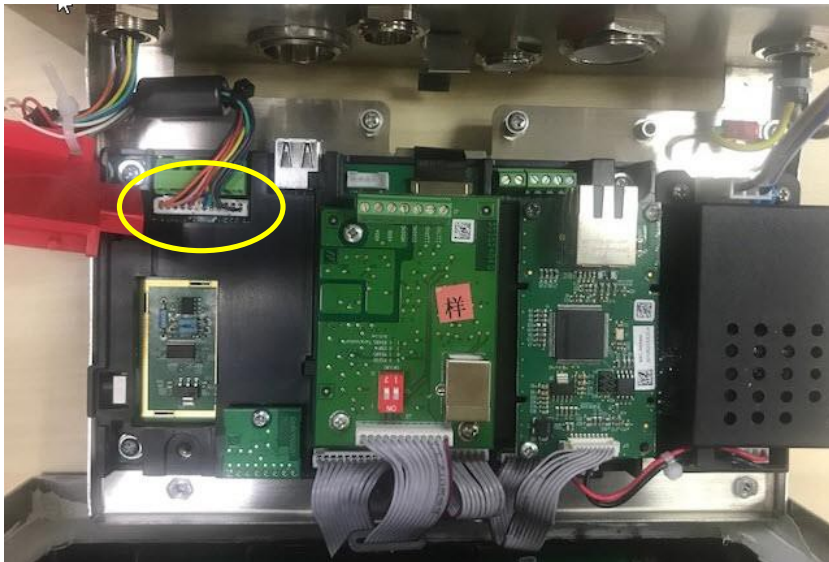

### Installing Load Cell Cable and Connectors

In order to meet certain electrical noise emission limits and to protect i-DT61PW and i-DT61XWE from external influences, it is necessary to install a ferrite core on the load cell cable connected to the terminal. The ferrite core is included with the terminal.

To install the ferrite, simply route the cable through the center of the core and then take one wrap around the outside of the core and route the cable through the center again. Either the complete cable or the individual wires can be wrapped through the ferrite. This should be done as close to the enclosure as possible. See Figure 2-1.



Figure 2-1

**Main Board Wiring Connections**

Once the i-DT61PW and i-DT61XWE enclosure is opened, connections can be made to the terminal blocks on the main board as shown in Figure 2-2.

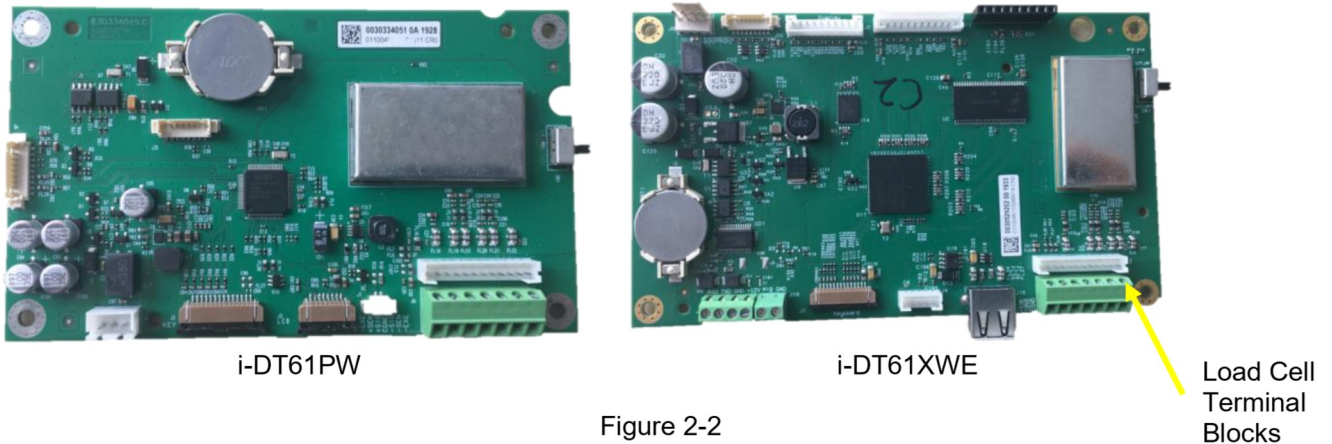
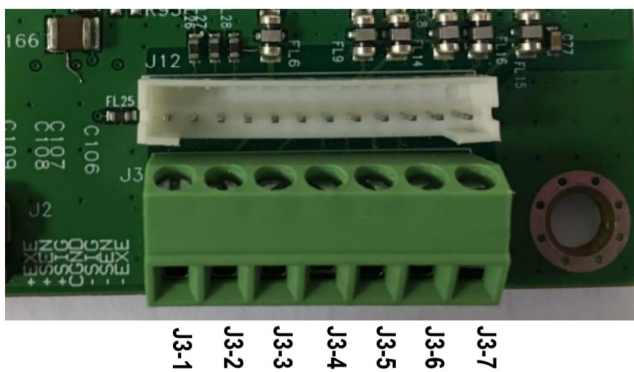

Figure 2-2

**Jumper Connections**

The i-DT61PW and i-DT61XWE indicators are designed to support both 2mV/V and 3mV/V load cells from the same circuitry. A load cell output rating selection jumper is not required.

Figure 2-3 shows the terminal definitions for the analog load cell terminal blocks. Note that when using four-wire load cells, jumpers must be placed between the +Excitation and +Sense terminals and between the -Excitation and -Sense terminals.



Pin	Connection
J3-1	+EXC
J3-2	+SEN
J3-3	+SIN
J3-4	GND
J3-5	-SIN
J3-6	-SEN
J3-7	-EXC

Figure 2-3 Jumper Connections

After wiring is completed, replace the indicator housing screws. Make sure the water-proof cable gland is properly tightened.

**2.3.3 Communication Interface Cable to i-DT61PW**

Attach the IR Communication cable (P/N: 30572910) to the indicator front panel, make sure the two holes in the interface cable module match the two bolts which located in the front panel.

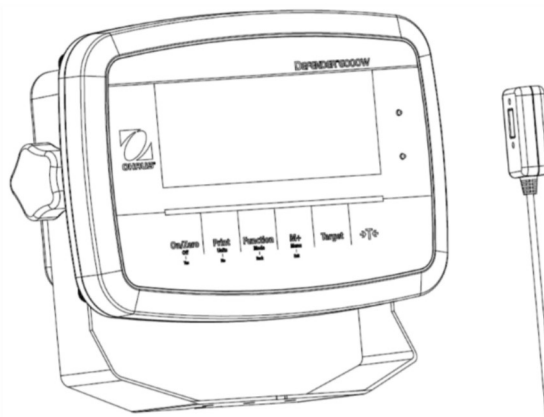

Figure 2-4



### 2.3.4 RS232 Interface Cable to i-DT61XWE

Pass the optional RS232 cable through the strain relief and attach it to the RS232 connector on the mainboard. Tighten the strain relief to maintain a watertight seal. Please refer to Figure 2-7 for the position of the serial port connector RXD TXD and GND.

**Note:**

- Please refer to Opening the Housing section for how to open the case of the terminal.
- For details about Discrete Input0 function, please refer to the **Discrete I/O (for i-DT61XWE)** section for details.



Figure 2-5  
Strain Relief for Option

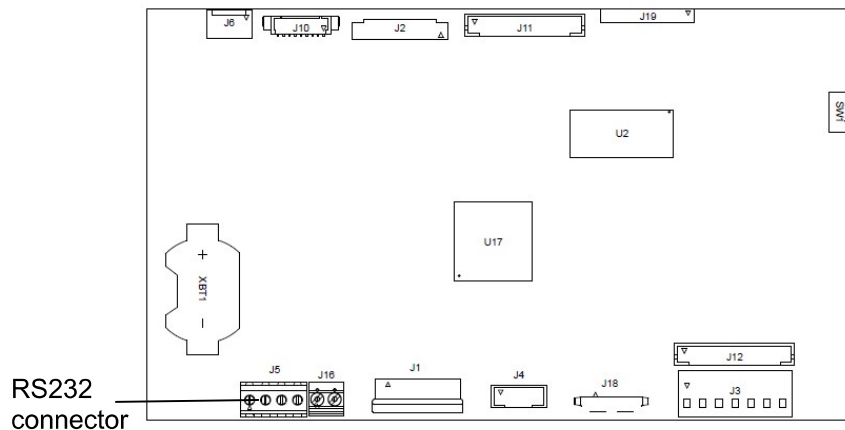

Figure 2-6 RS232 connector on the mainboard

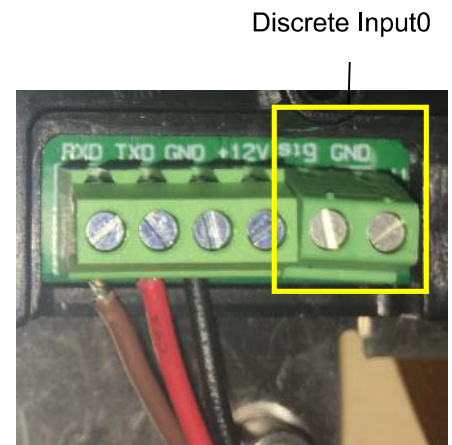

Figure 2-7  
RS232 connector

## 2.4 Mounting Bracket

Attach the bracket to a wall or table using fasteners (not supplied) that are appropriate for the type of mounting surface. The bracket will accommodate up to 6 mm (1/4") diameter screws. Locate the mounting holes as shown in Figure 2-8 and 2-9.

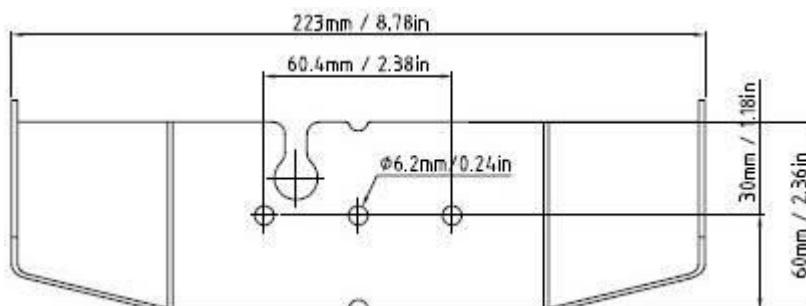

Figure 2-8 i-DT61PW  
Mounting Bracket Dimensions

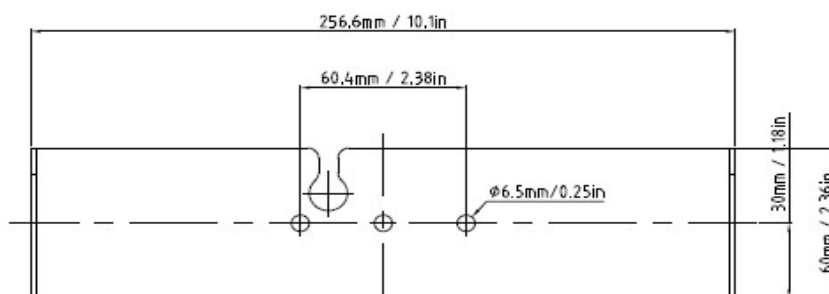

Figure 2-9 i-DT61XWE  
Mounting Bracket Dimensions

## 3. OPERATION

### 3.1 Turning the Scale On/Off

To turn the scale on, press and hold the **On/Zero Off** button for 1 second. The scale performs a display test, momentarily displays the software version, and then enters the active weighing mode.

To turn the scale off, press and hold the **On/Zero Off** button until **OFF** is displayed.

### 3.2 Weighing Mode

Use this application to determine the weight of items in the selected unit of measure. This mode is the factory default setting.

#### 3.2.1 Enter the Mode and Start Weighing

To enter the weighing mode from any application mode:

1. Press and hold the **Mode** button until **WEIGH** is displayed.
2. If needed, place an empty container on the pan and press the  button to tare.
3. Add sample to the pan or container. The display shows the weight of the sample.

**Note:** Please refer to the **Check** section for how to use Check in the Weighing mode.

#### 3.2.2 Accumulation and Statistics

The Accumulation feature enables manual or automatic totalizing of displayed values. Statistical data (total accumulated weight, min/max weights, pieces, percent, and total number of samples) is stored in memory for review and printing. Accumulation works together with each application mode except Filling, but the accumulation data will be cleared when change to another mode.

##### 3.2.2.1 Settings

There are four accumulation options:

- Off (**OFF**): disable accumulation function.
- Manual (**MANUAL**): press the **M+** button to do accumulation manually.
- Auto (**AUTO**): the scale will perform accumulation automatically.
- Accept (**ACCEPT**): the scale will perform accumulation automatically in the **Check** mode when the weight on the pan is acceptable between the under and over value you set.

To set accumulation options:

1. Long press the **Menu** button until you see **C.A.L.**
2. Short Press the **No** button one time. When you see **S.E.T.U.P.**, press the **Yes** button.
3. Short Press the **No** button several times to navigate until you see **ACCUM**. Press the **Yes** button.
4. Short Press the **No** button several times to select the accumulation option you want. The four options have been introduced above. Then press the **Yes** button to confirm.
5. Press the **Exit** button to exit.

##### 3.2.2.2 Accumulation

###### Manual

Place the item on the scale and press the **M+** button to add the weight to accumulation. The  $\Sigma$  pointer will keep flashing until the weight is removed and the platform is stable.

###### Auto

Place the item on the scale. The displayed value is accumulated automatically. The  $\Sigma$  pointer will keep flashing until the weight is removed and the platform is stable.

###### Accept

Place the item on the scale in check mode. The displayed value is accumulated automatically when the weight is acceptable between the under and over value you set.

##### 3.2.2.3 Viewing and Clearing Statistical Data

When the pan is cleared, press the **M+** button to view the accumulation and statistics results.

To clear the accumulation data, press the **CLR** button on i-DT61XWE terminal or the  button on i-DT61PW terminal while the statistical information is displayed. When the display shows **CLR.ACC**, press the

**Yes** button to clear the stored data and return to current mode.

**Notes:**

- The item must be removed from the pan before the next item can be accumulated.
- Only stable weights are stored.
- Changing modes will clear the stored accumulation data.
- When Legal for Trade is turned ON, for NTEP, gross and net weight cannot be added to the same total. If the first weight is recorded in gross, the future ones should be recorded in the same way. It is the same for net weight.

### 3.2.3 Check

Use this application to compare the weight of items to a target weight range. This mode is available for Weighing, Counting, Percent, and Dynamic.

#### 3.2.3.1 Set Check Limits

##### i-DT61PW

1. Press the **Target** button from Weighing, Counting, Percent or Dynamic mode to set check limits.
2. The display shows **UNdEr**.
3. Press the **Yes** button to edit the under value.
4. If there is a stored under value of the last time, the display will show it. For example: 1.0kg.
  - Press the **Yes** button if you want to use this value. Then the display shows **Over**.
  - Press the **No** button if you do not want to use this value, and skip to step 6.
5. If there is no stored value, the display shows **000000**.
6. To set a new under value, short press the **No** button several times until the desired number appears. Short press the **Yes** button to accept the number and move to the next digit. Repeat the process until all the digits are correct. Press the **Yes** button to accept the value. Then the display shows **Over**.
7. Repeat step 2 to 6 to set the over value.
8. If the values you set are invalid, the display will show **--n0--** and go back to reset.
9. If the values you set are valid, the display will go to check weighing screen.

##### i-DT61XWE

1. Press the **Target** button from Weighing, Counting, Percent or Dynamic mode to set check limits.
2. The display shows **UNdEr**.
3. Press the **Yes** button to edit the under value.
4. If there is a stored under value of the last time, the display will show it.
  - Press the **Yes** button if you want to use this value.
  - Press the **No** button if you do not want to use this value or do not have a stored value. Input the needed one with the numeric keypad. Press the **Yes** button to accept the under value.
5. The display will show **Over**.
6. Repeat step 2 and 3 to set the over value.
7. If the values you set are invalid, the display will show **--n0--** and go back to reset.
8. If the values you set are valid, the display will go to check weighing screen.

#### 3.2.3.2 Positive Check

Positive check is used to determine when the material added to the scale is within the target range. In this case the under and over values must be positive values. (The over value must be greater than the under value.) Add material to the scale platform until the display shows it is within the Accept (green) range.

#### 3.2.3.3 Negative Check

Negative check is used to determine when the material removed from the scale is within the target range. In this case the under and over values are both negative values. The under value must be greater than the over value. (For example: the under value is -10; the over value is -15).

Place the item to be weighed on the scale and press the  button.  
Remove a portion of the item until it is within the acceptable range.

#### 3.2.3.4 Zero Check

Zero check is used when comparing subsequent samples to an initial reference sample. In this case, the under value must be a negative value and the over value must be a positive one.

Place the reference item on the scale and press the  button.  
Remove material from the scale platform until the display shows it is within the Accept (green) range.

### 3.2.3.5 Clear Check Limits

Long press the **Target** button until the display shows the under and over values.

Press the **CLR** button of i-DT61XWE indicator or the  button of i-DT61PW indicator, the display shows **CLr.CHr**. Press the **Yes** button to clear both the under and over values.

### 3.2.4 Application Settings

The application can be customized for user preferences.

To enter application settings:

1. Long press the **Menu** button until you see **C.R.L**. Short press the **No** button several times until you see **M.N.d.E**. Press the **Yes** button to enter the application mode settings.
2. Short press the **No** button several times to navigate until you see the selection you want.
3. Press the **Yes** button to select.
4. Repeat step 2 and 3 several times until you finish all settings.
5. Press the **Exit** button to exit.

The Weighing Configurations are defined below (defaults in Bold).

Item	Available Settings	Comments
Weighing ( <b>LWE IGH</b> )	On, Off	To enable Weighing

**Note:** you cannot disable Weighing if you are in the mode currently.

### 3.3 Counting Mode

Use this application to count samples of uniform weight.

#### 3.3.1 Enter the Mode

To enter the mode:

1. Press and hold the **Mode** button until **COUNT** is displayed.
2. When the **Mode** button is released, the display shows **CLR.PWJ**.
3. If you need to clear the stored APW of the last time, press the **Yes** button. Then go to **Establish an APW** section.  
**Note:** if the weight on the pan is larger than 1d, the display will show **CLR.PAN** until the weight is removed from the pan.
4. If you need to recall the stored APW of the last time and continue to use it, press the **No** button to start counting.  
**Note:** if no APW has been set before, step 3 and 4 will be omitted.

#### 3.3.2 Establish an APW

To establish an APW:

1. Follow the previous step 4.
  - **i-DT61PW:**  
 The display shows the sample size **Pwt. 10**. To change it, short press the **No** button several times until you see the value you want.  
**Note:** available sample size selections are 5, 10, 20, 50 and 100 (The default is 10).
  - **i-DT61XWE:**  
 The display flashes with the current sample size, such as 10 Pcs. To change it, input the new sample size through the numeric keyboard. Do not press the **Yes** button until you finish the next step.
2. Place the specified quantity of samples on the pan and press the **Yes** button to capture the current stable weight.

**Note:**

- During the capture process, the display shows - - - - -. (i-DT61PW)
- You can press the  button to tare. The center of zero, PT or NET icons will light as appropriate.
- If the APW is between 0.1d and 1d, the display shows **LD.rEF** for 1.5 seconds. Then it will start counting.
- If the APW is less than 0.1d, the display shows **rEF.Err** for 1.5 seconds and then return to showing what is displayed on step 1. Please replace the samples on the pan and press the **Yes** button to re-establish an APW value.

#### 3.3.3 Start Counting

1. Place parts on the pan and read the number. The number of pieces and the Pcs icon are displayed.
2. Press the **Function** button to temporarily display the APW. **APWJ** is displayed for 0.5 seconds. Then the APW value is displayed for 1.5 seconds using the current unit of measurement.

**Note:** Please refer to **Check** in the **Weighing Mode** section for how to use Check in the Counting mode.

#### 3.3.4 Application Settings

The application can be customized for user preferences. Please refer to **Application Settings** section in **Weighing Mode** for details about how to enter application settings.

The Counting Configurations are defined below (defaults in Bold).

Item	Available Settings	Comments
Count ( <b>COUNT</b> )	<b>On</b> , Off	To enable Counting
Auto Opt. ( <b>A.OPE</b> )	<b>On</b> , Off	Off: Auto Opt. is off. <b>On:</b> The APW will be optimized automatically during count weighing.

**Note:** you cannot disable Count if you are in the mode currently.

### 3.4 Percent Mode

Use this application to measure the weight of a sample displayed as a percentage of a pre-established reference weight.

#### 3.4.1 Enter the Mode

To enter the percent mode from any application mode:

1. Press and hold the **Mode** button until **PERCENT** is displayed.
2. When the **Mode** button is released, the display shows **CLR.REF** and the % icon.
3. If you need to clear the stored reference weight of the last time, press the **Yes** button. Then go to step 5.  
**Note:** If captured weight is more than or equal to 1d or is less than or equal to -1d, the display will show **CLR.PAN** until the sample is removed from the pan.
4. If you need to recall the stored reference weight of the last time and continue to use it, press the **No** button and start percent weighing.  
**Note:** If no reference weight has been previously stored, step 3 and 4 will be omitted.
5. The display shows the **PUT.REF** and the % icon.

#### 3.4.2 Establish a Reference Weight

To establish a reference weight:

Follow the previous step 5. When you see **PUT.REF** displayed on the screen, place the specified quantity of samples on the pan and press the **Yes** button to capture the current stable weight.

**Note:**

- You can press the  button to tare. The center of zero, PT or NET icons will light as appropriate.
- For i-DT61PW model, during the capture process, the display shows - - - - -.
- If the reference weight is less than 100d during the capture process, the display will show **REF.Err** for 1.5 seconds and then return to showing **PUT.REF**. Please replace the samples on the pan and press the **Yes** button to re-establish a reference weight.

#### 3.4.3 Start Percent Weighing

1. Place a sample on the pan and read the percent. The current percent value and % icon are displayed.
2. Press the **Function** button to temporarily display the reference weight. **REF.Wgt** is displayed for 0.5 seconds. Then the reference weight value is displayed for 1.5 seconds in the current unit of measurement.

**Note:** Please refer to **Check** in the **Weighing Mode** section for how to use Check in the Percent Weighing mode.

#### 3.4.4 Application Settings

The application can be customized for user preferences. Please refer to **Application Settings** section in **Weighing Mode** for details about how to enter application settings.

The Percent Weighing Configurations are defined below (defaults in Bold).

Item	Available Settings	Comments
Percent ( <b>PERCENT</b> )	<b>On</b> , Off	To enable Percent Weighing

**Note:** you cannot disable Percent if you are in the mode currently.

### 3.5 Dynamic Mode

Use this application to weigh an unstable load, such as a moving animal.

#### 3.5.1 Enter the Mode

To enter the Dynamic Weighing Mode from any application mode:

1. Press and hold the **Mode** button until **ԺԿՈՐՐԴ** is displayed.
2. The display shows **ԻԷՐՁԿ**.

#### 3.5.2 Start Dynamic Weighing

1. To start:
  - When operation type is manual. Place the load (more than or equal to 5d) on the pan and press the **Function** button to start the averaging process.
  - When operation type is semi-automatic/automatic. Place the load (more than or equal to the Start Weight) on the pan, and the terminal will start averaging process automatically

**Note:** The display must be at zero gross or net value before placing the load on the pan.
2. During the averaging period, the countdown timer decreases in one second increments (For example, the set average time is 5s).
 

**Note:** If the set average time is 0s, the countdown timer is not displayed.
3. The readings are averaged and held on the display when the countdown has completed in both Countdown and Continuous mode.
 

In addition, for DT61XWE model:

  - The tilde symbol will blink indicating that the current weight is being held in Countdown Mode.
  - The tilde symbol will blink indicating that the current weight is being averaged in real time in Continuous Mode.

**Note:** If the set average time is 0s, the first weight larger than 5d will be displayed and hold.
4. To reset the countdown timer:
  - When the operation type is manual/semi-automatic, press the **Function** button to reset the countdown timer when the countdown is running. The display shows **ԻԷՐՁԿ**, and start to re-count.
  - When operation type is automatic, remove the load from the pan, and the average weight will still be displayed until the duration time is over. Then the display shows **ԻԷՐՁԿ**, and start to re-count.

**Note:**

  - The **ԻԷՐՁԿ** display must be at zero gross or net value in order to reset the countdown timer.
  - Please refer to **Check** in the **Weighing Mode** section for how to use Check in the Dynamic Weighing mode.

#### 3.5.3 Application Settings

The application can be customized for user preferences. Please refer to **Application Settings** section in **Weighing Mode** for details about how to enter application settings.

The Dynamic Weighing Configurations are defined below (defaults in Bold).

Item	Available Settings	Comments
Dynamic Mode (ԺԿՈՐՐԴ)	<b>Countdown (Հ.ԺՅԼՆԴ)</b> / Continues (ՀՕՈԷ)/ Off (ՕԲԲ)	<b>Count down:</b> There is a countdown time. <b>Continuous:</b> Averaging will be continued after the countdown time.
Dynamic Operation Type (Ժ.ԷԿՄԲԷ)	<b>Manul (ԲԴՐՐ)</b> / Semi-auto (ՏԷՐԴ Ի)/ Auto (ԲԱԷՕ)	<b>Manual:</b> The averaging process is started and reset manually. <b>Semi-auto:</b> The averaging process is started automatically and reset manually. <b>Auto:</b> The averaging process is started and reset automatically.
Start Weight (Տ.ԼՆՃԷ)	0 ~ Capacity Weight	Dynamic weighing will start when the load is bigger than the start weight (for Semi-auto and Auto mode).
Duration Time (Ժ.Է ԻՐԴԷ)	1 ~ 10 s	It is the time for the display to remain the dynamic weighing result after the load is removed.
Average Time (Բ.Է ԻՐԴԷ)	0 ~ 30 s	Time in Seconds. If the average time is 0, the first stable weight (more than or equal to 5d) will be the result.

**Note:** you cannot disable Dynamic if you are in the mode currently.

## 3.6 Filling Mode

Use this application to fill a container to a pre-determined target weight.

**Note:** filling mode is only available for i-DT61XWE model.

### 3.6.1 Enter the Mode

To enter the Filling mode from any application mode:

1. Press and hold the **Mode** button until **F LL** is displayed.
2. The actual weight is displayed on the display.

### 3.6.2 Start Filling

1. When the scale is in stop or pause status, press the **Function** button to start filling process. The output port will be enabled.
2. Add weight on the pan. When one set point (SP1/SP2/SP3/SP4) is reached, the related output port will be disabled.
3. When the scale is in start or pause status, press the **Function** button to stop filling process. The output port will be all disabled.

### 3.6.3 Resume and Pause Filling

1. When the scale is in pause status, press the **Target** button to resume the filling process. The output port will be enabled or disabled according to the current load value.
2. When the scale is in start status, press the **Target** button to pause the filling process. The output port will be all disabled, and the display will be frozen.

### 3.6.4 Display of the Dot Matrix Screen

The Dot Matrix Display will be divided into one to four columns according to how many set points (SP) are valid. The maximum is four columns. For example, if you set four SPs, then the screen will be divided into four columns. In addition, the screen will display different colors according to the load value.

For example:

1. You set four valid SP values and SP1 is less than SP2, SP2 less than SP3, SP3 less than SP4. Then the screen will be divided into four columns.

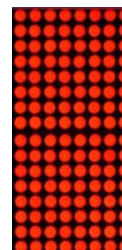

2. To start filling, if the first load is less than SP1, the first column displays orange, and others red.

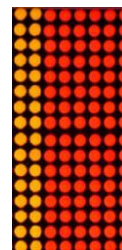

3. If continue to fill the second time, and the total load is now more than or equal to SP1 while less than SP2, the first column displays green, the second orange, and others red.

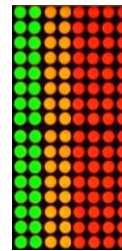



- 4. After that to fill the third time, if the total load is now more than or equal to SP2 while less than SP3, the first two columns display green, the third orange, and others red.

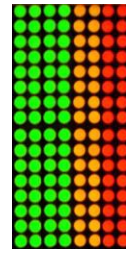

- 5. To load the fourth time, if the total load is now more than or equal to SP3 while less than SP4, the first three columns display green, and the fourth one orange.



- 6. Nevertheless, if the total load is more than SP4, all the four columns turn red and the instrument will be in a stop state.

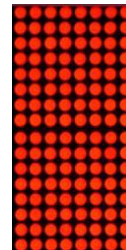

### 3.6.5 Application Settings

The application can be customized for user preferences. Please refer to **Application Settings** section in **Weighing Mode** for details about how to enter application settings.

The Filling Configurations are defined below (defaults in Bold)

Item	Available Settings	Comments
Filling ( <b>F ILL</b> )	<b>On</b> , Off	To enable Filling Weighing

**Note:** you cannot disable Filling if you are in the mode currently.

# 4. MENU SETTINGS

The User Menu allows the customizing of scale settings.

**Note:** Additional Sub-Menus may be available if Interface Options are installed. See Interface User Manual for the additional setting information.

## 4.1 Menu Navigation

### 4.1.1 User Menu

For i-DT61PW model

C.A.L	S.E.t.U.P	r.E.A.d	U.n.i.t	U.n.i.t	G.M.P	A.S.2.3.2	P.r.i.N.t	L.o.c.t	E.n.d
ZE-rD	rESEt	rESEt	rESEt	rESEt	rESEt	rESEt	rESEt	rESEt	
SPAN	C.U.N It	StAbLE	WJE IGX	kg	d.FF7t	bAUd	ASS IGX	L.ALL	
L INE	CAP	ZE-rD	COUNt	g	dAtE	PAR ItY	StAbLE	L.OFF	
GEO	GrAd	F ILtEr	A.OPt	lb	t.FF7t	StOP	770dE	L.ZE-rD	
C.t.ESt	P.ZE-rD	A2t	PE-rCt	oz	t.777E	H.SHAPE	t.777E	L.Pr INt	
End	P.U.N It	b.L IGXt	dYNA77	lb;oz	P. Id	ALt.P	C.SUM7	L.U.N It	
	A.tArE	S.SAUEr	d.tYPE	End	S. Id	ALt.t	tE777P	L.777dE	
	ACCUM7	A.OFF	d.t.777E		End	ALt.2	End	L.777ENU	
	t.CNt	P.SAUER	A.t.777E			End		L.tArE	
	t.NE7t	End	End					L.tArGE	
	End							End	

For i-DT61XWE model

C.A.L	S.E.t.U.P	r.E.A.d	U.n.i.t	U.n.i.t	G.M.P	A.S.2.3.2	P.r.i.N.t	I.O.	L.o.c.t	L. I.b	U.S.E.r	U.S.b	E.n.d
ZE-rD	rESEt	rESEt	rESEt	rESEt	rESEt	rESEt	rESEt	rESEt	rESEt	NEtJ	NEtJ	rESEt	
SPAN	C.U.N It	StAbLE	WJE IGX	kg	d.FF7t	bAUd	ASS IGX	tYPE	L.ALL	Ed It	Ed It	tYPE	
L INE	rANGE	ZE-rD	PE-rCt	g	dAtE	PAR ItY	StAbLE	INPUt 1	L.OFF	End	End	E.777ENU	
GEO	CAP 1	F ILtEr	dYNA77	lb	t.FF7t	StOP	770dE	INPUt2	L.ZE-rD			777ENU	
C.t.ESt	GrAd 1	A2t	d.tYPE	oz	t.777E	H.SHAPE	t.777E	OUt 1	L.Pr INt			E.L Ib	
End	CAP2	L IGXt	S.tJt	lb;oz	P. Id	ALt.P	C.SUM7	OUt2	L.U.N It			77 Ib	
	GrAd2	S.SAUEr	d.t.777E	End	S. Id	ALt.t	tE777P	OUt3	L.FUNC			E.USEr	
	P.ZE-rD	A.OFF	A.t.777E		End	ALt.2	End	OUt4	L.777dE			777E	
	P.U.N It	L.tEY	F ILL			End		End	L.777ENU			LENGtX	
	A.tArE	End	End						L.tArE			S.d IG It	
	ACCUM7								L.tArGE				
	t.bEEP								End				
	t.CL Ict												
	bP.S IG												
	L.S IGX												
	7r.FUNC												
	7r.AdJ												
	t.CNt												
	t.NE7t												
	P.tJd.ER												
	P.tJd												
	End												

**Notes:**

Some modes/units may not be available in all models.

When LEGAL FOR TRADE is turned **ON** (the lock switch is in the locked position), the menu settings will be affected as below:

- Calibration (**C.A.L**) menu is not accessible.

- Zero Range setting is locked at 2%.
- Stable Range setting is locked at 1d.
- Auto-Zero Tracking setting is locked at 0.5d.
- Filter and Units are locked at their current settings.
- Stable Only is locked to be **On**.
- Auto Print/Continuous is disabled.
- Lb;oz unit is locked Off.

#### 4.1.2 Button Navigation

- The **Yes** button: allows entry into the displayed menu.  
Accepts the displayed setting and advances to the next item.
- The **No** button: rejects entry into the displayed menu.  
Rejects the displayed menu and move on to the next selection.
- The **Back** button: moves backwards through the upper and middle level menus.  
Backs out of a list of selectable items to the previous middle level menu.
- The **Exit** button: exits from menu directly to the active weighing mode.

For menu items with numeric settings such as Capacity, the current setting is displayed with all digits flashing. To revise:

1. Press the **No** button to begin editing.
2. The first digit is displayed flashing.
3. Press the **No** button to increase the digit or press the **Yes** button to accept the digit and move to the next one.
4. Repeat this process for all digits.
5. Press the **Yes** button when the last digit has been set.
6. The new setting is displayed with all digits flashing. Press the **Yes** button to accept the setting or press the **No** button to resume editing.
7. To end the current menu selection, press the **Yes** button to advance to the next menu, or press the **No** button to return to the top of the current menu.

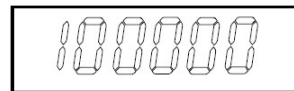
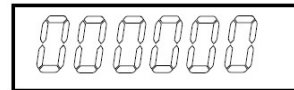

**Note:** For i-DT61XWE model, the numeric value can be input by the numeric keypad directly.

## 4.2 Calibration Menu

Enter this menu to perform calibrations.

### 4.2.1 Initial Calibration

When the scale is operated for the first time, a zero and span calibration are recommended to ensure accurate weighing results.

Before performing the calibration, be sure to have the appropriate calibration weights as listed in table 4-1. Ensure that the LFT switch/calibration lock is set to the unlocked position.

Or adjust the GEO setting according to your location.

TABLE 4-1

Required Span Calibration Mass (sold separately)			
Max	Mass*	Max	Mass*
3000g	3kg / 5lb	30000g	30kg / 50lb
6000g	6kg / 10lb	60000g	60kg / 100lb
15000g	15kg/25lb	150000g	150kg / 250lb

**Note:**

- When active unit is g or kg, the calibrating unit will be in kg.
- When active unit is lb, oz or lb:oz, the calibrating unit will be in lb.
- For linearity calibration, the calibration Mass is fixed. The Mid-point is always half of the full capacity.

### 4.2.2 Zero Calibration [ZE-0]

Zero calibration uses one calibration point. The zero calibration point is established with no weight on the scale. Use this calibration method to adjust for a different static load without affecting the span or linearity calibration.

**Calibration procedures:**

1. Long press the **Menu** button until you see **C.A.L.** Press the **Yes** button.
2. The display shows **ZE-0**. Press the **Yes** button.
3. The display flashes **0** kg and the calibration unit. With no weight on the pan, press the **Yes** button to establish the zero point.
4. The display shows **--C--**, and then **-DONE-** when the Zero calibration is finished.

**Note:**

If zero calibration is failed or if after 40 seconds the calibration is still not successful, **CAL E** is displayed for 3 seconds and the previous calibration data is restored. The scale exits to the active weighing mode and displays the actual weight value in the current weighing unit.

5. Then the display shows **SPAN**. Press the **Exit** button to exit.

### 4.2.3 Span Calibration [SPAN]

Span calibration uses one point. The span calibration point is established with a calibration mass placed on the scale.

**Note:** Span calibration should be performed after zero calibration.

**Calibration procedures:**

1. Long press the **Menu** button until you see **C.A.L.** Press the **Yes** button.
2. Short press the **No** button to navigate until you see **SPAN**. Press the **Yes** button.
3. The display flashes with the calibration point and calibration unit based on the capacity and unit set in the capacity menu. (e.g. **030.000** kg). If you do not need to change the calibration point, skip to step 5.
4. To change the calibration point:
  - i-DT61PW: short press the **No** button several times until the desired digit appears. Short press the **Yes** button to accept the digit and move to the next one. Repeat the process until all the digits are correct. Press the **Yes** button to accept the calibration point. The display flashes with the calibration point you set.
  - i-DT61XWE: input the calibration point through the numeric keys. (Do not press the **Yes** button until you finish step 5.)
5. Place a calibration mass of the specified weight on the pan and press the **Yes** button.

6. The display shows **--[ ]--**, and then **-DONE-** when the calibration is finished.
7. Then the display shows **L [ ]**. Press the **Exit** button to exit.

**Note:**

- If calibration is failed, **CAL E** is displayed for 3 seconds and the previous calibration data is restored. The scale exits to the active weighing mode and displays the actual weight value in the current weighing unit.
- If after waiting for 40s the calibration is still not successful, **CAL E** is displayed for 3 seconds and the previous calibration data is restored. The scale exits to the active weighing mode and displays the actual weight value in the current weighing unit.

**4.2.4 Linearity Calibration [L [ ]]**

Linearity calibration uses 3 calibration points. The full calibration point is established with a weight on the scale. The mid calibration point is established with a weight equal to half of the full calibration weight on the scale. The zero calibration point is established with no weight on the scale. The full calibration and mid calibration points can be altered by the user during the calibration procedure.

**Calibration procedures:**

1. Long press the **Menu** button until you see **C.A.L.** Press the **Yes** button.
2. Short press the **No** button several times to navigate until you see **L [ ]**. Press the **Yes** button.
3. The display flashes with **0 kg** and the calibration unit. With no weight on the pan, press the **Yes** button to establish the zero point.
4. The display shows **--[ ]--**, and then moves to flash with the first calibration point and calibration unit based on the capacity and unit you set in the capacity menu. (For example, **0 15.000 kg**). If you do not need to change the calibration point, skip to step 6.
5. To change the calibration point:
  - i-DT61PW: short press the **No** button several times until the desired digit appears. Short press the **Yes** button to accept the digit and move to the next one. Repeat the process until all the digits are correct. Press the **Yes** button to accept the calibration point. The display flashes with the calibration point you set.
  - i-DT61XWE: input the calibration point through the numeric keys. (Do not press the **Yes** button here until you finish step 6).
6. Place a calibration mass of the specified weight on the pan and press the **Yes** button.
7. The display shows **--[ ]--**, and then moves to flash with the second calibration point and calibration unit based on the capacity and unit you set in the capacity menu. (For example, **030.000 kg**).

**Note:**

If after waiting for 40s the calibration is still not successful, **CAL E** is displayed for 3 seconds and the previous calibration data is restored. The scale exits to the active weighing mode and displays the actual weight value in the currently selected weighing unit.

8. Repeat step 5 and 6.
9. The display shows **--[ ]--**, and then **-DONE-** when the Linearity calibration is finished.
10. Then the display shows **GEO**. Press the **Exit** button to exit.

**4.2.5 GEO Adjustment [GEO]**

Geographical Adjustment Factor (GEO) is used to adjust the calibration based on the current location. Settings from 0 to 31 are available with 12 being the default.

Please refer to the **Table of Geo Values** section in the **Technical Data** chapter to determine the GEO factor that corresponds to your location.

To set the GEO factor:

1. Long press the **Menu** button until you see **C.A.L.** Press the **Yes** button.
2. Short press the **No** button several times to navigate until you see **GEO**. Press the **Yes** button.
3. The display flashes with the Geo point (For example, **12**).
4. Short press the **No** button several times until the desired GEO number appears. Press the **Yes** button to finish setting.
5. Then the display shows **C.tESEt**. Press the **Exit** button to exit.

#### 4.2.6 Calibration Test [C.L.E5t]

##### Calibration test procedures:

1. Long press the **Menu** button until you see **C.A.L.** Press the **Yes** button.
2. Short press the **No** button several times to navigate until you see **C.L.E5t**. Press the **Yes** button.
3. The display flashes with **0** and the calibration unit based on the capacity and unit you set in the capacity menu. With no weight on the pan, press the **Yes** button to establish the zero point.
4. The display shows **--t--** while the zero point is recorded.
5. The display flashes with the calibration weight and the unit of the last time. (For example, **0 15.000** kg).
6. To change the test calibration weight:
  - i-DT61PW: short press the **No** button several times until the desired digit appears. Short press the **Yes** button to accept the digit and move to the next one. Repeat the process until all the digits are correct. Press the **Yes** button to accept the calibration point.
  - i-DT61XWE: press the numeric keys to edit the weight. (Do not press the **Yes** button here until you finish step 7).
7. Place the specified test weight on the pan and press the **Yes** button.
8. The display flashes with the difference between the calibration data and the test weight. (For example, **0.0 10** kg). If the terminal is connected to a printer or other devices, the result of the Calibration Test will be printed.
9. After 5 seconds, the test ends and the scale returns to the active weighing mode with the display of the current weight.

#### 4.2.7 End Cal [End]

When **End** is displayed, press the **Yes** button to exit this menu and advance to the next Sub-menu or press the **No** button to advance to the first menu item in the this Sub-menu.

### 4.3 Setup Menu

Enter this menu **5.E.t.U.P** to set scale parameters. Default settings are in **bold**.

For i-DT61PW model

Menu	Sub-Menu	Sub-Menu (in segment)	Options	Options (in segment)
Setup 5.E.t.U.P	Reset	rESEt	no, yes	<b>NO, YES</b>
	Capacity Unit	C.UN t	kg, lb, t, g	/
	Capacity	CAP	1-999999	/
	Graduation	GrAd	0.0001~100	/
	Power On Zero	P.ZEr0	Off, <b>On</b>	<b>OFF, ON</b>
	Power On Unit	P.UN t	<b>Auto</b> , g, kg, lb, oz, lb:oz, t	<b>AUTO</b>
	Auto Tare	A.tArE	<b>Off</b> , On, Accept	<b>OFF, ON, ACCEPT</b>
	Accumulation	ACCUM	<b>Off</b> , Auto, Manual, Accept	<b>OFF, MANUAL, AUTO, ACCEPT</b>
	Transaction Counter	t.CNt	Off, <b>On</b>	<b>OFF, ON</b>
	Next Transaction	t.NEXt	1-999999	/
	End	End	\	/

For i-DT61XWE model

Menu	Sub-Menu	Sub-Menu (in segment)	Options	Options (in segment)
Setup 5.E.t.U.P	Reset	rESEt	no, yes	<b>NO, YES</b>
	Capacity Unit	C.UN t	kg, lb	/
	Range	r.RANGe	<b>Single</b> , Dual	<b>SINGLE, DUAL</b>
	> 1 < Capacity	CAP 1	1-999999	/
	> 1 < Graduation	GrAd 1	0.0001~100	/
	> 2 < Capacity [Range=Dual]	CAP 2	1-999999	/
	> 2 < Graduation [Range=Dual]	GrAd 2	0.0001~100	/
	Power On Zero	P.ZEr0	Off, <b>On</b>	<b>OFF, ON</b>
	Power On Unit	P.UN t	<b>Auto</b> , g, kg, lb, oz, lb:oz	<b>AUTO</b>
	Auto Tare	A.tArE	<b>Off</b> , On, Accept	<b>OFF, ON, ACCEPT</b>
	Accumulation	ACCUM	<b>Off</b> , Auto, Manual, Accept	<b>OFF, MANUAL, AUTO, ACCEPT</b>
	Key Beep	t.bEEP	Off, <b>On</b>	<b>OFF, ON</b>
	Key Click Type	t.CL ICt	<b>single</b> , double	<b>SINGLE, DOUBLE</b>
	Check beep signal	bP.S IG	<b>off</b> , under, over, accept, under-over	<b>OFF, UNDER, OVER, ACCEPT, UN-OV</b>
	Check light signal	L.S IG	<b>block</b> , bar, segment	<b>BLOCK, BAR, SEGMENT</b>
	IR Func	Ir.FUNc	<b>Disp</b> , Zero, Tare, Print	<b>dISP, ZEr0, tArE, Pr INt</b>
	IR Adjust	Ir.AdJ	OFF, LOW, <b>HI</b>	<b>OFF, LOW, HI</b>
	Transaction Counter	t.CNt	Off, <b>On</b>	<b>OFF, ON</b>
	Next Transaction	t.NEXt	1-999999	/
	PasswordEnable	P.Wd.d.EN	<b>Off</b> , On	<b>OFF, ON</b>
End	End	\	/	

**Reset [rESEt]**

Reset the Setup menu to factory defaults.

**no** = do not reset

**YES** = reset

**Capacity Unit [C.UN tE]**

Select the unit used for calibration.

t (Metric Tonne)

g

**kg**

lb

**Note:** t and g are not available for i-DT61XWE model.

**Range [rRNGE]**

**Note:** This setting is only available for i-DT61XWE model.

Set the number of weighing intervals.

This terminals can be configured to use single or dual interval. Each interval can be assigned its own graduation. If dual interval is selected, the graduation will change when the weight reaches the second interval.

When **Single** interval is selected, the additional parameters available are:

>|1|< Capacity

>|1|< Graduation

When **Dual** interval is selected, the terminal functions with two intervals, each with its own capacity and graduation. In addition to the Interval 1 capacity and graduation parameters, the following two parameters are available:

>|2|< Capacity

>|2|< Graduation

**Capacity [CAP] / Capacity1 [CAP 1]**

Set the capacity of the scale or the capacity of the first scale (for i-DT61XWE model).

1...999999

**Grad [GrAd] / Grad1 [GrAd 1]**

Set the scale readability or the readability of the first scale for i-DT61XWE model from 0.0001 to 100.

0.0001~100

**Capacity2 [CAP2]**

Set the capacity of the second scale for i-DT61XWE model.

**Grad2 [GrAd2]**

Set the readability of the second scale for i-DT61XWE model.

**Power On Zero [P.ZEr0]**

Zero the scale at Power On.

**OFF** = disabled.

**On** = enabled.

**Power On Unit [P.UN tE]**

Set the unit that will be displayed at Power On.

**RUt0** = last unit in use when turned off

kg = kilograms

g = grams

lb = pounds

oz = ounces

lb:oz = pound ounces

t = metric tonne (only available for i-DT61PW model)